

Linear Transient Analysis of Laminated Composite Plates using GLPT

Miroslav S. Marjanović*¹, Đorđe M. Vuksanović²

^{1,2}University of Belgrade, Faculty of Civil Engineering, Bulevar kralja Aleksandra 73, 11000, Belgrade, Serbia

(Accepted 28 August 2013; Published online 30 September 2013)

Abstract

The objective of this work is to study the transient response of laminated composite plates under different types of dynamic loading. For this purpose, laminated composite plate is modeled using Reddy's generalized layerwise plate theory (GLPT). This theory assumes layerwise linear variation of displacements components. Transverse displacement is constant through the thickness of the plate. Using the assumed displacement field, linear kinematic relations, as well as Hooke's constitutive law, equations of motion are derived using Hamilton's principle. Analytical solution for cross-ply laminates is derived using the Navier method. Numerical solution is obtained using FEM. Governing partial differential equations in both solutions are reduced to a set of ordinary differential equations in time using Newmark integration scheme. The equations of motion are solved using constant-average acceleration method. Effects of time step, mesh refinement and lamination scheme on accuracy of transient response are considered. Illustrative comments are given about the influence of shear deformation on transient response. Finally, different schemes of dynamic loading are investigated. Good agreement is obtained with results from the literature.

Rezumat

Obiectivul acestei lucrări este de a studia răspunsul tranzitoriu al plăcilor compozite laminate sub diferite tipuri de încărcare dinamică. În acest scop, placa compozită laminată este modelată folosind teoria generalizată a plăcilor propusă de Reddy (GLPT). Această teorie presupune variația liniară a componentelor deplasării în raport cu straturile plăcii. Deplasarea transversală este constantă în grosimea plăcii. Ecuațiile de mișcare sunt derivate folosind principiul lui Hamilton, utilizând câmpul de deplasare asumat, relațiile liniare cinematice, precum și legea constitutivă a lui Hooke. Soluția analitică pentru plăci laminate din fibre din lemn încrucișate este derivată folosind formula lui Navier. Soluția numerică este obținută cu ajutorul metodei elementului finit. Ecuațiile cu derivate parțiale în ambele soluții sunt reduse la un set de ecuații diferențiale ordinare în timp, utilizând Metoda Newmark. Ecuațiile de mișcare sunt rezolvate folosind metoda de integrare implicită Newmark β . Sunt luate în considerare efectele integrării numerice în timp, pas cu pas, ale rafinării discretizării și ale sistemului de laminare asupra acurateței răspunsului tranzitoriu. Sunt prezentate comentarii ilustrative despre influența deformării cauzate de forfecare asupra răspunsului tranzitoriu. În cele din urmă, sunt investigate diferite scheme de încărcare dinamică. Rezultatele obținute sunt în concordanță cu cele din literatura de specialitate.

Keywords: laminated plate, transient analysis, Navier solution, FEM, Newmark integration

1. Introduction

Laminar composites play an important role in the design and construction of aircrafts, ships, and many other parts in machine industry. They attract great attention in a field of Civil Engineering, too, and their massive use in structural design is expected. They can be used as main load carrying members in the form of thick laminated and sandwich plates [1]. Suitability for different design purposes due to their great stiffness to weight ratios is highly valued. Laminates are often composed of several orthotropic layers (laminas, plies). Layer orthotropic behavior comes from the high-strength fibers, which are oriented in predefined direction for each layer individually. In the case of cross-ply laminated composite plates, ply fibers are oriented alternately, with angles of 0° or 90° . Different orientation of plies forms symmetric or anti-symmetric lamination schemes. Composite laminates are often exposed to different types of static and transient dynamic loading. They are characterized by significant transverse shear deformations. This all leads to the need for the accurate modeling of thick composite plates: displacement continuity conditions must be fulfilled at layer interfaces. This crucial condition is satisfied by the use of layerwise plate theory, which will be explained in this work.

Different plate theories are derived for the analysis of composite laminates. Global behavior can be accurately determined by the use of relatively simple equivalent-single-layer laminate theories (ESL) [2], especially for thin laminates. In the case of thicker structural components, ESL theories are not adequate, so refined theory is needed to account for the thickness (shear) effects. Vuksanović investigated single layer models of higher order, which represent plate kinematics with improved accuracy [3]. ESL theories cannot account for discontinuities in transverse shear strains at the interfaces between layers of different stiffnesses. Another problem is the analysis of local effects, such as matrix cracking, delamination or free edge effect. For these reasons there is a need for applying layerwise plate theories. In the layerwise approach, it is assumed that C^0 -continuity through thickness of the laminate is satisfied. The plate is analyzed as a multilayered in the true sense of word (each layer is considered separately). Cross-sectional warping is taken into account, which is much more kinematically correct representation of displacements. Shear deformation (considerable as a result of plate's anisotropic structure) is included.

In this paper, Generalized Layerwise Plate Theory of Reddy [4] is used to analyze transient response of laminated composite plates. It allows independent interpolation of in-plane and out-of-plane displacement components. Piece-wise linear variation of in-plane displacement components, and constant transverse displacement through the thickness are imposed. Consistent mass matrix is employed in the dynamic analysis. In the displacement-based FE formulation, only C^0 -continuity is needed, so the nodal variables are translation components. The goal of this work is to present the both analytical and numerical solution for the transient response of laminated plate. Solutions are obtained using MATLAB[®] and compared with existing data from the literature.

2. Formulation of the generalized layerwise theory

2.1 Assumptions

We will consider a laminated plate composed of n orthotropic layers. Physical layers in the laminate are numbered starting from the bottom layer. Mid-plane coordinates are (x, y, z) . Typical laminated composite plate in global coordinate system is shown in Figure 1.

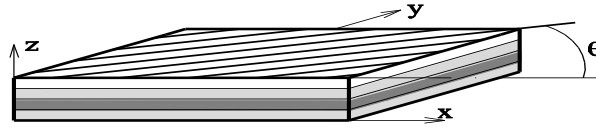

Figure 1. Laminated composite plate (4 layers)

Derivation of Generalized Laminated Plate Theory is based on following assumptions: (1) all laminas are perfectly bonded together (no relative displacements exist at layer inter-faces), (2) all layers are of uniform thickness, (3) material is linearly elastic, (4) all layers are orthotropic, (5) strains are small and (6) inextensibility of normal is imposed.

2.1 Displacement field

Displacement field (u_1, u_2, u_3) in the point (x, y, z, t) of laminated plate can be written as:

$$\begin{aligned}
 u_1(x, y, z, t) &= u(x, y, t) + \sum_{I=1}^N u^I(x, y, t) \Phi^I(z) \\
 u_2(x, y, z, t) &= v(x, y, t) + \sum_{I=1}^N v^I(x, y, t) \Phi^I(z) \\
 u_3(x, y, z, t) &= w(x, y, t)
 \end{aligned} \tag{1}$$

In Eq. (1), (u, v, w) are displacement components in three orthogonal directions in the mid-plane of the plate, (u^I, v^I) are coefficients which will be calculated later, and $\Phi^I(z)$ are layerwise continuous functions of the thickness coordinate (linear, quadratic or cubic Lagrangian interpolations of thickness coordinate), which can be found in [2]. In Eq. (1), t denotes arbitrary time point. For the purpose of this work, linear interpolation is chosen through the thickness coordinate. In the FEM analysis, (u^I, v^I) are the nodal values of (u_1, u_2) in the I^{th} numerical layer through the plate thickness. N is the number of layers through thickness of the laminate (or the number of nodes in z -direction in FE discretization). Generalized displacements through the plate thickness are shown in Figure 2.

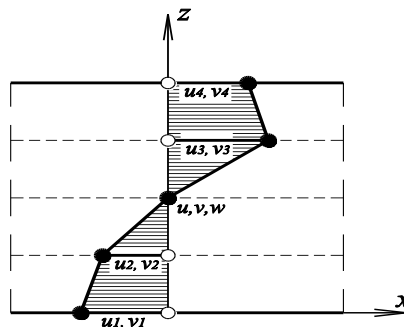

Figure 2. Displacement components in GLPT, for 4-layer plate

2.2 Kinematic relations of lamina

Linear strain – displacement relations (2) are assumed as follows: in-plane deformation components are continuous through the plate thickness, while the transverse strains need not to be. Constitutive equations of single ply are used in deriving constitutive equations of laminate.

$$\begin{aligned}
 \varepsilon_x &= \frac{\partial u_1}{\partial x} = \frac{\partial u}{\partial x} + \sum_{I=1}^N \frac{\partial u^I}{\partial x} \Phi^I & \gamma_{xz} &= \frac{\partial u_1}{\partial z} + \frac{\partial u_3}{\partial x} = \sum_{I=1}^N u^I \frac{d\Phi^I}{dz} + \frac{\partial w}{\partial x}
 \end{aligned}$$

$$\begin{aligned}\varepsilon_y &= \frac{\partial u_2}{\partial y} = \frac{\partial v}{\partial y} + \sum_{I=1}^N \frac{\partial v^I}{\partial y} \Phi^I & \gamma_{yz} &= \frac{\partial u_2}{\partial z} + \frac{\partial u_3}{\partial y} = \sum_{I=1}^N v^I \frac{d\Phi^I}{dz} + \frac{\partial w}{\partial y} \\ \gamma_{xy} &= \frac{\partial u_1}{\partial y} + \frac{\partial u_2}{\partial x} = \frac{\partial u}{\partial y} + \frac{\partial v}{\partial x} + \sum_{I=1}^N \left(\frac{\partial u^I}{\partial y} + \frac{\partial v^I}{\partial x} \right) \Phi^I\end{aligned}\quad (2)$$

2.3 Constitutive equations of lamina

The stress-strain relations for k^{th} lamina can be written as:

$$\begin{Bmatrix} \sigma_x \\ \sigma_y \\ \tau_{xy} \\ \tau_{xz} \\ \tau_{yz} \end{Bmatrix}^{(k)} = \begin{bmatrix} Q_{11} & Q_{12} & Q_{16} & 0 & 0 \\ Q_{12} & Q_{22} & Q_{26} & 0 & 0 \\ Q_{16} & Q_{26} & Q_{66} & 0 & 0 \\ 0 & 0 & 0 & Q_{55} & Q_{45} \\ 0 & 0 & 0 & Q_{45} & Q_{44} \end{bmatrix}^{(k)} \begin{Bmatrix} \varepsilon_x \\ \varepsilon_y \\ \gamma_{xy} \\ \gamma_{xz} \\ \gamma_{yz} \end{Bmatrix}^{(k)}\quad (3)$$

In Eq. (4), $Q_{ij}^{(k)}$ are transformed elastic coefficients of k^{th} lamina in global coordinate system.

2.4 Equations of motion

When deriving the dynamic equilibrium of virtual strain energy (U), virtual work of external forces (V) and virtual kinetic energy (K), it is assumed that loading q is acting in the middle plane of the plate. This loading works on virtual displacement w in the mid-plane of the plate. Homogeneous boundary conditions on the surface are imposed. Dynamic expressions for U , V and K are given in Eq. (4):

$$\begin{aligned}\delta U &= \int_0^t \int_0^V \left(\sigma_x \delta \varepsilon_x + \sigma_y \delta \varepsilon_y + \tau_{xy} \delta \gamma_{xy} + \tau_{xz} \delta \gamma_{xz} + \tau_{yz} \delta \gamma_{yz} \right) dV dt & \delta V &= - \int_0^t \int_0^V \left(q(x, y, t) \delta w \right) dV dt \\ \delta K &= - \int_0^t \int_0^V \rho \left(\ddot{u}_1 \delta u_1 + \ddot{u}_2 \delta u_2 + \ddot{u}_3 \delta u_3 \right) dV dt\end{aligned}\quad (4)$$

Dynamic version of virtual work statement can be derived using Hamilton principle:

$$\begin{aligned}\delta U &= \int_0^t \int_0^\Omega \left\{ N_x \frac{\partial \delta u}{\partial x} + N_y \frac{\partial \delta v}{\partial y} + N_{xy} \left(\frac{\partial \delta u}{\partial y} + \frac{\partial \delta v}{\partial x} \right) + Q_x \frac{\partial \delta w}{\partial x} + Q_y \frac{\partial \delta w}{\partial y} + \right. \\ &\quad \left. + \sum_{I=1}^N \left(N_x^I \frac{\partial \delta u^I}{\partial x} + N_y^I \frac{\partial \delta v^I}{\partial y} + N_{xy}^I \left(\frac{\partial \delta u^I}{\partial y} + \frac{\partial \delta v^I}{\partial x} \right) + Q_x^I \delta u^I + Q_y^I \delta v^I \right) \right\} d\Omega dt \\ \delta V &= - \int_0^t \int_0^\Omega \left(q \delta w \right) d\Omega dt\end{aligned}\quad (5)$$

$$\delta K = - \int_0^t \int_0^\Omega \left\{ I_0 \left(\ddot{u} \delta u + \ddot{v} \delta v + \ddot{w} \delta w \right) + \sum_{I=1}^N I^I \left(\ddot{u}^I \delta u + \ddot{v}^I \delta v + \ddot{u} \delta u^I + \ddot{v} \delta v^I \right) + \right. \\ \left. + \sum_{I=1}^N \sum_{J=1}^N I^{IJ} \left(\ddot{u}^I \delta u^J + \ddot{v}^I \delta v^J \right) \right\} d\Omega dt$$

$$\delta U + \delta V + \delta K = 0\quad (6)$$

2.5 Stress resultants

As stated before, q is the uniform transverse loading – time function - acting in the mid-plane. Stress resultants $\{N\}$ and inertia terms $\{I\}$ are derived in [1, 2, 5]:

$$\begin{aligned}
 I_0 &= \sum_{k=1}^n \int_{z_k}^{z_{k+1}} \rho_k dz & I^I &= \sum_{k=1}^n \int_{z_k}^{z_{k+1}} \rho_k \Phi^I dz & I^{IJ} &= \sum_{k=1}^n \int_{z_k}^{z_{k+1}} \rho_k \Phi^I \Phi^J dz \\
 \begin{Bmatrix} N_x \\ N_y \\ N_{xy} \end{Bmatrix} &= \sum_{k=1}^n \int_{z_k}^{z_{k+1}} \begin{Bmatrix} \sigma_x \\ \sigma_y \\ \tau_{xy} \end{Bmatrix}^{(k)} dz & \begin{Bmatrix} N_x^I \\ N_y^I \\ N_{xy}^I \end{Bmatrix} &= \sum_{k=1}^n \int_{z_k}^{z_{k+1}} \begin{Bmatrix} \sigma_x \\ \sigma_y \\ \tau_{xy} \end{Bmatrix}^{(k)} \Phi^I dz \\
 \begin{Bmatrix} Q_x \\ Q_y \end{Bmatrix} &= \sum_{k=1}^n \int_{z_k}^{z_{k+1}} \begin{Bmatrix} \tau_{xz} \\ \tau_{yz} \end{Bmatrix}^{(k)} dz & \begin{Bmatrix} Q_x^I \\ Q_y^I \end{Bmatrix} &= \sum_{k=1}^n \int_{z_k}^{z_{k+1}} \begin{Bmatrix} \tau_{xz} \\ \tau_{yz} \end{Bmatrix}^{(k)} \frac{d\Phi^I}{dz} dz
 \end{aligned} \tag{7}$$

3. Analytical (Navier) solution for simply supported cross-ply laminates

Navier solution of GLPT is derived for simply supported rectangular cross-ply laminates, with dimensions $a \times b$ [8]. Boundary conditions in this case are:

$$\begin{aligned}
 v = w = v^I = N_x = N_x^I = 0 \quad x = 0, a \\
 u = w = u^I = N_y = N_y^I = 0 \quad y = 0, b
 \end{aligned} \tag{8}$$

We have to choose appropriate displacement field to satisfy boundary conditions (8) on the edges of the simply supported laminated composite plate and Euler-Lagrange equations of motion (6):

$$\begin{aligned}
 u(x, y, t) &= \sum_{m=1}^{\infty} \sum_{n=1}^{\infty} X_{mn}(t) \cdot \cos \frac{m\pi x}{a} \sin \frac{n\pi y}{b} \\
 v(x, y, t) &= \sum_{m=1}^{\infty} \sum_{n=1}^{\infty} Y_{mn}(t) \cdot \sin \frac{m\pi x}{a} \cos \frac{n\pi y}{b} \\
 w(x, y, t) &= \sum_{m=1}^{\infty} \sum_{n=1}^{\infty} W_{mn}(t) \cdot \sin \frac{m\pi x}{a} \sin \frac{n\pi y}{b} \\
 u^I(x, y, t) &= \sum_{m=1}^{\infty} \sum_{n=1}^{\infty} R_{mn}^I(t) \cdot \cos \frac{m\pi x}{a} \sin \frac{n\pi y}{b} \\
 v^I(x, y, t) &= \sum_{m=1}^{\infty} \sum_{n=1}^{\infty} S_{mn}^I(t) \cdot \sin \frac{m\pi x}{a} \cos \frac{n\pi y}{b}
 \end{aligned} \tag{9}$$

Loading should be expanded in double trigonometric series in a same manner.

$$q(x, y, t) = \sum_{m=1}^{\infty} \sum_{n=1}^{\infty} q_{mn}(t) \cdot \sin \alpha x \cdot \sin \beta y \tag{10}$$

In (9, 10), m and n denote number of members in Fourier series. X_{mn} , Y_{mn} , W_{mn} , R_{mn}^I , S_{mn}^I are Fourier coefficients - time functions - which are chosen only in a way such that u , v , w , u^I and v^I satisfy Eq. (6). Second part of the expansion determines the spatial variation of the transient

solution. After incorporation of Eq. (9) and Eq. (10) in Eq. (6), we derive the matrix form of virtual work statement. If cross-ply laminates are analyzed, some elements in matrix of elastic coefficients are identically zero, as shown in [5], so compacted matrix form of Eq. (6) becomes:

$$\begin{bmatrix} k & k^I \\ k^I & k^{II} \end{bmatrix} \begin{Bmatrix} X_{mn}(t) \\ Y_{mn}(t) \\ W_{mn}(t) \\ R_{mn}^I(t) \\ S_{mn}^I(t) \end{Bmatrix} + \begin{bmatrix} m & m^I \\ m^I & m^{II} \end{bmatrix} \begin{Bmatrix} \ddot{X}_{mn}(t) \\ \ddot{Y}_{mn}(t) \\ \ddot{W}_{mn}(t) \\ \ddot{R}_{mn}^I(t) \\ \ddot{S}_{mn}^I(t) \end{Bmatrix} = \begin{Bmatrix} 0 \\ 0 \\ -q_{mn}(t) \\ 0 \\ 0 \end{Bmatrix} \quad (11)$$

Submatrices $[k]$, $[k^I]$ and $[k^{II}]$ are in detail derived in [5]. Here we will derive the submatrices of consistent mass matrix:

$$m = \begin{bmatrix} I_0 & 0 & 0 \\ 0 & I_0 & 0 \\ 0 & 0 & I_0 \end{bmatrix} \quad m^I = \begin{bmatrix} I^I & 0 \\ 0 & I^I \\ 0 & 0 \end{bmatrix} \quad m^{II} = \begin{bmatrix} I^{II} & 0 \\ 0 & I^{II} \end{bmatrix} \quad (12)$$

In Eq. (11), $\{\Delta\}$ is a vector of Fourier coefficients and $\{\ddot{\Delta}\}$ is a vector of second derivations of Fourier coefficients. If we observe discrete time point t_n , following matrix equation which satisfies equilibrium conditions is:

$$[K]\{\Delta\}_n + [M]\{\ddot{\Delta}\}_n = \{F\}_n \quad (13)$$

In Eq. (13), subscripted n denotes appropriate value in discrete time point t_n . Superposed dots denote differentiation with respect to time. Global stiffness matrix $[K]$, as well as consistent mass matrix $[M]$, remains constant in all time points. If homogenous initial conditions (displacements and velocities) are assumed, X_{mn} , Y_{mn} , W_{mn} , R_{mn}^I and S_{mn}^I and their first derivatives in time are zero. Distributed loading $\{F\}$ acts perpendicular to the mid-plane of plate.

4. Finite element model

Layerwise finite element consist of mid-plane and N numerical layers (excepting the middle plane) through the thickness of the plate, as shown on Figure 3. Adopted nodal degrees of freedom are translations in three orthogonal directions in the mid-plane (u_i, v_i, w_i) and relative translations (u_i^I, v_i^I) in I^{th} numerical layer through the plate thickness.

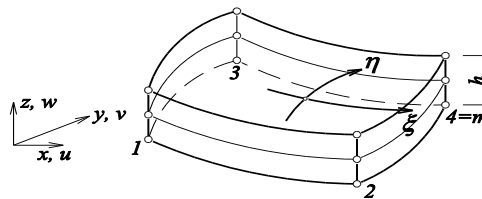

Figure 3. Layerwise FE with n layers and m nodes

Generalized displacements satisfy C^0 continuity condition on element boundaries. Displacement field is interpolated using the Lagrangian interpolation functions:

$$(u, v, w, u', v') = \sum_{i=1}^m (u_i, v_i, w_i, u'_i, v'_i) \psi_i \tag{14}$$

In Eq. (14), index m denotes the number of nodes per element. For this purpose, 4-node Lagrange quadrilateral is chosen. Interpolation is obtained using standard 2D Lagrangian polynomials ψ_i . If we incorporate Eq. (14) into the virtual work principle given in Eq. (6), we will derive equilibrium equations of single FE in matrix form. It is possible to derive the stiffness matrix and the consistent mass matrix of the single layerwise FE:

$$[K] = \int_{\Omega^e} \begin{bmatrix} [B]^T [A] [B] & \sum_{I=1}^N [B]^T [B^I] [\bar{B}] \\ \sum_{I=1}^N [\bar{B}]^T [B^I] [B] & \sum_{I,J=1}^N [\bar{B}]^T [D^{IJ}] [\bar{B}] \end{bmatrix} d\Omega^e \tag{15}$$

$$[M] = \int_{\Omega^e} \begin{bmatrix} I_0 [\Psi]^T [\Psi] & \sum_{I=1}^N I^I [\bar{\Psi}]^T [\bar{\Psi}] \\ \sum_{I=1}^N I^I [\bar{\Psi}]^T [\bar{\Psi}] & \sum_{I,J=1}^N I^{IJ} [\bar{\Psi}]^T [\bar{\Psi}] \end{bmatrix} d\Omega^e \tag{16}$$

In Eq. (15), $[A]$, $[B^I]$ and $[D^{IJ}]$ are constitutive matrices of the laminate, which are derived in [5]. Kinematic matrices are:

$$[B] = \begin{bmatrix} \psi_{1,x} & 0 & 0 & & \\ 0 & \psi_{1,y} & 0 & & \\ \psi_{1,y} & \psi_{1,x} & 0 & \dots & \\ 0 & 0 & \psi_{1,x} & & \\ 0 & 0 & \psi_{1,y} & & \end{bmatrix} \quad [\bar{B}] = \begin{bmatrix} \psi_{1,x} & 0 & & & \\ 0 & \psi_{1,y} & & & \\ \psi_{1,y} & \psi_{1,x} & \dots & & \\ \psi_1 & 0 & & & \\ 0 & \psi_1 & & & \end{bmatrix}_{5 \times 2m} \tag{17}$$

In Eq. (16), I_0 , I^I and I^{IJ} are inertia terms previously derived in Eq. (7), and matrices of interpolation functions are:

$$[\Psi] = \begin{bmatrix} \psi_1 & & & \\ & \psi_1 & \dots & \\ & & \psi_1 & \dots \end{bmatrix}_{3 \times 3m} \quad [\bar{\Psi}] = \begin{bmatrix} \psi_1 & & & \\ & \psi_1 & \dots & \end{bmatrix}_{2 \times 2m} \quad [\bar{\bar{\Psi}}] = \begin{bmatrix} \psi_1 & 0 & & \\ & \psi_1 & 0 & \dots \end{bmatrix}_{2 \times 3m} \tag{18}$$

Dynamic equilibrium equation of the single FE is given in following matrix equation:

$$[M] \{\ddot{\Delta}\} + [K] \{\Delta\} = \{f\} \tag{19}$$

In Eq. (19), $\{\Delta\}$ and $\{f\}$ are vectors of nodal displacements and forces of the single FE, respectively. If we observe discrete time point t_n , matrix equation which satisfies Eq. (19) is:

$$[M] \{\ddot{\Delta}\}_n + [K] \{\Delta\}_n = \{f\}_n \tag{20}$$

Layerwise elements suffer from the phenomena such as spurious shear stiffness. Because of this, Selective integration scheme S1 is used to avoid the shear locking in calculation. In this scheme, all terms in the element stiffness matrix which contain the transverse shear stiffnesses Q_{44} , Q_{45} and Q_{55}

are computed using reduced (1×1) integration. All remaining terms are calculated using full (2×2) integration. Integration over each FE is performed using Gauss-Legendre quadrature.

5. Transient analysis

In the preceding sections, we have derived the governing partial differential equations of the problem. In the analytical solution, spatial variation of displacements is assumed using Navier method, and in numerical (FE) solution displacement field is interpolated using the Lagrangian polynomials. In this way we have derived the set of ordinary differential equations in time (13 and 20). These equations can be solved exactly using either the Laplace transform method or the modal analysis method [2]. These methods require the determination of eigenvalues and eigenfunctions. Analytical solutions can be found in previous works of Vuksanović, Hinton [6-7]. In this work, numerical solution will be adopted, using Newmark's integration scheme for second-order differential equations.

5.1 Time discretization

In the Newmark method, accelerations and velocities are approximated using truncated Taylor's expansions and only terms up to the second derivative are included [2]. Therefore solution is obtained only for discrete times and not as a continuous function of time. Among several well-known Newmark integration schemes, constant-average acceleration method is chosen for this purpose. This stable scheme provided that introduced approximation error does not grow unboundedly. Detail revision of numerical time integration is given in [2]. Here the constant average acceleration method is explained. Approximated time functions and their derivatives are:

$$\begin{aligned} \{\Delta\}_{n+1} &= \{\Delta\}_n + \delta t \cdot \{\dot{\Delta}\}_n + \frac{1}{2}(\delta t)^2 \{\ddot{\Delta}\}_{n+\frac{1}{2}} & \{\dot{\Delta}\}_{n+1} &= \{\dot{\Delta}\}_n + \delta t \cdot \{\ddot{\Delta}\}_{n+\frac{1}{2}} \\ \{\ddot{\Delta}\}_{n+\frac{1}{2}} &= \frac{1}{2}\{\ddot{\Delta}\}_n + \frac{1}{2}\{\ddot{\Delta}\}_{n+1} \end{aligned} \quad (21)$$

In Eq. (21), δt is the time increment, n is the current time point and $n+1$ is the next time point in which we seek the solution. After substitution, we obtain:

$$\{\dot{\Delta}\}_{n+1} = \{\dot{\Delta}\}_n + \frac{1}{2}\delta t \cdot \{\ddot{\Delta}\}_n + \frac{1}{2}\delta t \cdot \{\ddot{\Delta}\}_{n+1} \quad \{\ddot{\Delta}\}_{n+1} = \frac{4}{(\delta t)^2}(\{\Delta\}_{n+1} - \{\Delta\}_n) - \frac{4}{\delta t}\{\dot{\Delta}\}_n - \{\ddot{\Delta}\}_n \quad (22)$$

Premultiplying the second Equation from (22) with $[M]_{n+1}$ and using Eq. (13) or Eq. (20) in t_{n+1} , we obtain (if stiffness matrix and consistent mass matrix is constant in all time points):

$$[\hat{K}]\{\Delta\}_{n+1} = \{\hat{F}\} \quad (23)$$

$$[\hat{K}] = [K] + \frac{4}{(\delta t)^2}[M] \quad \{\hat{F}\} = \{F\}_{n+1} + [M] \left(\frac{4}{(\delta t)^2}\{\Delta\}_n + \frac{4}{\delta t}\{\dot{\Delta}\}_n + \{\ddot{\Delta}\}_n \right) \quad (24)$$

Eq. (23) represents a system of algebraic equations among the discrete values (nodal displacements vector in FEA or vector of Fourier coefficients in Navier solution), at time t_{n+1} in terms of known values at time t_n . It is obvious that initial values of displacements, velocities and accelerations are needed for obtaining transient response of the structure. First two are known from homogenous initial conditions. However, acceleration vector should be calculated from following expression:

$$\{\ddot{\Delta}\}_0 = [M]^{-1} (\{F\}_0 - [K]\{\Delta\}_0) = [M]^{-1} \{F\}_0 \tag{25}$$

6. Numerical examples and discussion

Proposed methodology of obtaining the transient response through the analytical and numerical method was investigated on several examples presented in this chapter. Homogeneous initial conditions (zero displacements and velocities) were assumed in all cases. Preliminary calculations showed that number of members in double trigonometric series does not affect the results severely [8]. In the FE calculations, 10x10 mesh of 4-node quadrilaterals is chosen. All plates are simply supported on all sides. Whenever is possible, obtained results from the present model are compared with existing solutions from the literature. Some new results are presented. Nondimensionalized center transverse deflection is presented in all examples:

$$\bar{w} = w \frac{100E_2h^3}{q_0a^4} \tag{26}$$

In all calculations it was assumed that laminated structure is composed from arbitrary number of layers, which have the same mechanical properties, as in examples from the works of Reddy [2]:

$$\begin{aligned} E_1 &= 52.5 \times 10^6 \text{ N/cm}^2 & G_{12} &= G_{13} = 1.05 \times 10^6 \text{ N/cm}^2 & \nu_{12} &= 0.25 \\ E_2 &= 2.1 \times 10^6 \text{ N/cm}^2 & G_{23} &= 0.42 \times 10^6 \text{ N/cm}^2 & \rho &= 8 \times 10^{-6} \text{ N s}^2/\text{cm}^4 \end{aligned} \tag{27}$$

6.1 Influence of time increment

Influence of time increment was investigated with 2 thin cross-ply composite plates with characteristics given in (27): 2-layer plate (0/90) and 4-layer plate (0/90)₂. Different time steps were used. Increase of time increment reduced the amplitude of oscillations, but increased the period, as showed on Figures 4-7. Plates were exposed to uniformly distributed step loading, and calculation was made using both analytical method and FEM, as explained in preceding sections. Maximum transient center transverse deflections in both cases are about 2 times that of the static center transverse deflection. Both plates are squared. Plate dimensions are: a = b = 25 cm. Overall plate height is h = 1 cm (a/h = 25 – thin plate).

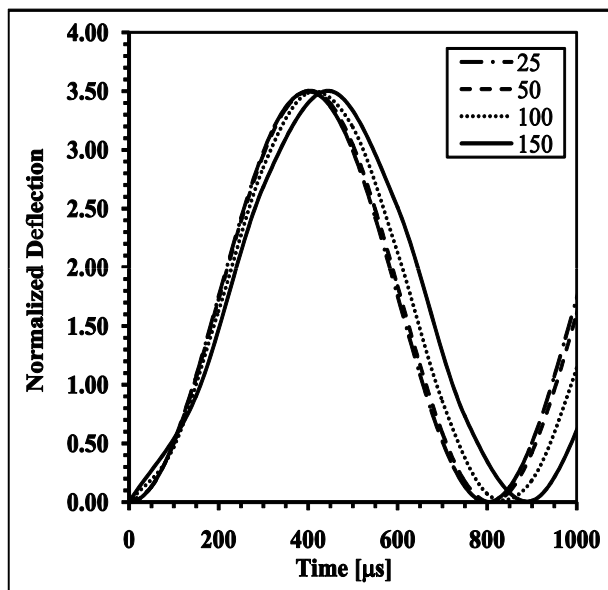

Figure 4. Analytical solution for (0/90) laminate for different time steps

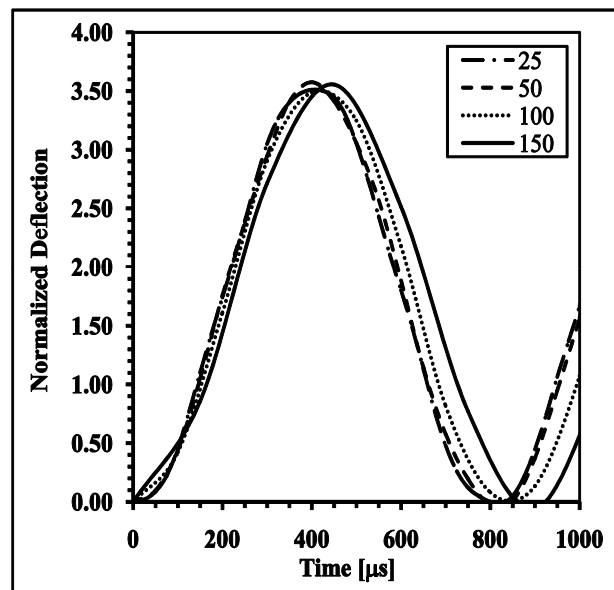

Figure 5. FEM solution for (0/90) laminate for different time steps

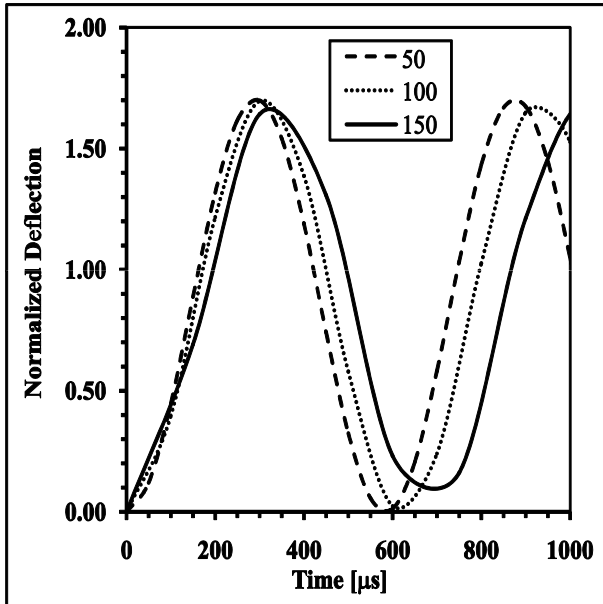

Figure 6. Analytical solution for (0/90)₄ laminate for different time steps

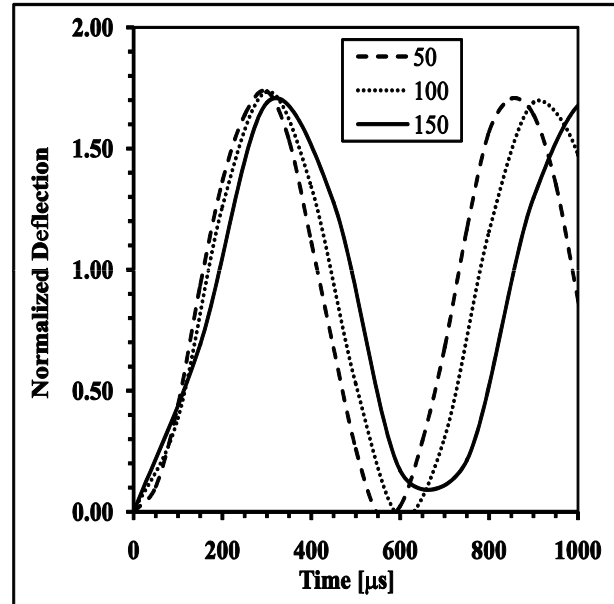

Figure 7. FEM solution for (0/90)₄ laminate for different time steps

2-layer plate (Analytical):	$\bar{w}_{max,dynamic} = 3.5025$	$\bar{w}_{max,static} = 1.7519$	$w_d/w_s = 1.9993$
2-layer plate (FEM):	$\bar{w}_{max,dynamic} = 3.5750$	$\bar{w}_{max,static} = 1.7556$	$w_d/w_s = 2.0363$
4-layer plate (Analytical):	$\bar{w}_{max,dynamic} = 1.6989$	$\bar{w}_{max,static} = 0.8936$	$w_d/w_s = 1.9012$
4-layer plate (FEM):	$\bar{w}_{max,dynamic} = 1.7360$	$\bar{w}_{max,static} = 0.8554$	$w_d/w_s = 2.0295$

6.2 Influence of FE mesh refinement

Influence of FE mesh refinement was investigated with 2 cross-ply plates made of 4 layers (0/90)₂, with characteristics given in (27). Two side-to-thickness ratios were used: $a/h=5$ and $a/h=25$.

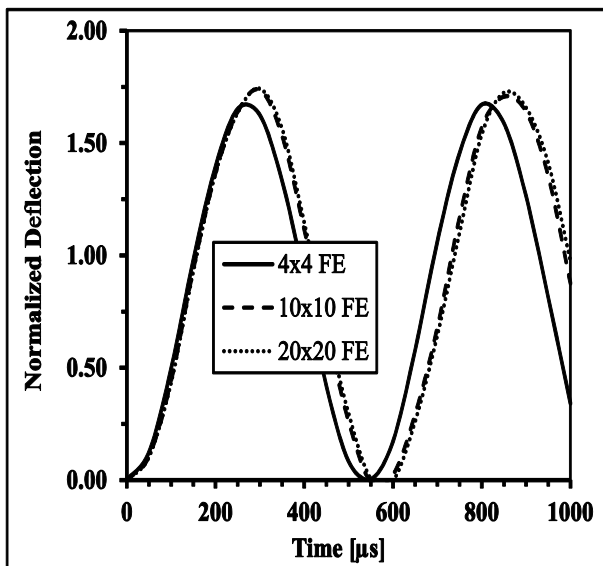

Figure 8. Normalized deflection versus time for (0/90) laminate with $a/h = 25$

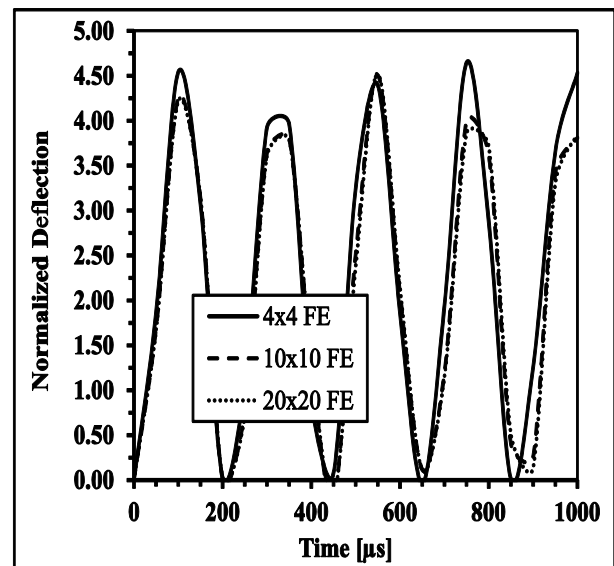

Figure 9. Normalized deflection versus time for (0/90) laminate with $a/h = 5$

Plates were exposed to uniformly distributed step loading. Time step of $\delta t = 50 \mu s$ was chosen in all calculations. Convergence of solution is reached with 10×10 FE mesh, so this refinement is adopted as fine mesh and used in all following calculations.

Coarse mesh of 4×4 FE showed a little underestimation of amplitude and the period in thin plate situation (Figure 8). In the thick plate situation (Figure 9), coarse mesh overpredicted the amplitude of oscillations, and underpredicted the period slightly.

6.3 Influence of shear deformation

Calculation was performed with 2 cross-ply (0/90) composite plates with characteristics given in (27). Plate dimensions are: $a = b = 25$ cm. Two side-to-thickness ratios were used: $a/h=10$ and $a/h=25$. Plates were exposed to uniformly distributed step loading, and calculation was made using both analytical method and FEM. Time step of $\delta t = 50 \mu s$ was chosen. The accuracy of the present model is verified with existing results from the literature [2].

As we can see from Figures 10 and 11, shear deformation affects the results in a following way: period of oscillations is increased, and the amplitude of oscillations is constant or increased. Slightly stronger influence is obtained by using the FEM solution. It is obvious that influence of shear deformation is much more pronounced in the case of thick plates, while in the thin plate situation it is almost negligible.

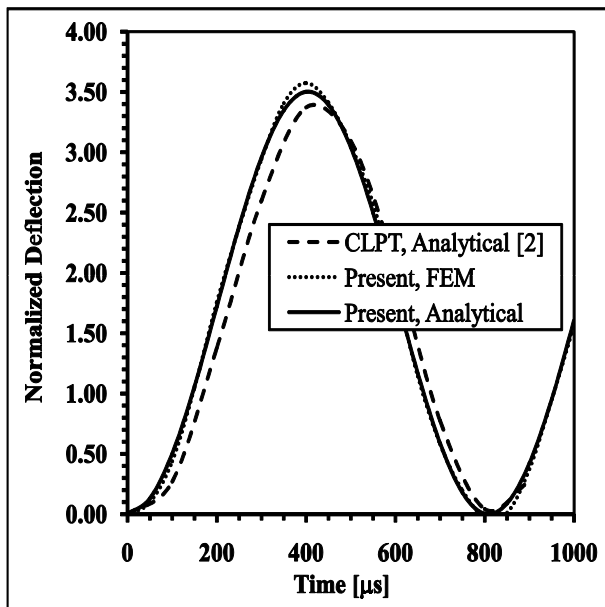

Figure 10. Normalized deflection versus time for (0/90) laminate with $a/h = 25$

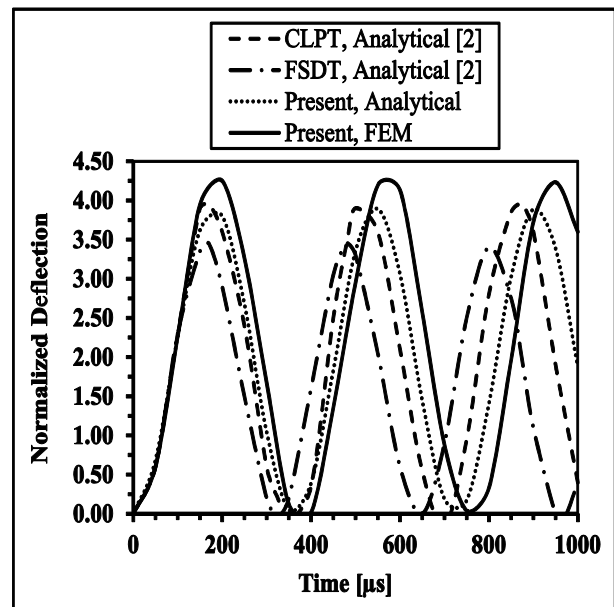

Figure 11. Normalized deflection versus time for (0/90) laminate with $a/h = 10$

6.4 Influence of lamination scheme

The effect of the lamination scheme on the transient response of laminated structure is investigated using a cross ply laminates with different numbers of layers. In all cases, uniformly distributed step loading was used. Calculation was performed using thin laminated composite plate, with $a = b = 25$ cm, and $a/h = 25$. Figure 12 shows that reduction in the number of layers through the plate thickness led to the more flexible plate response – it is increasing the amplitude as well as the period. By using more cross-ply layers through the same overall plate thickness, stiffer response is obtained. Very good agreement was obtained between analytical and FE solution.

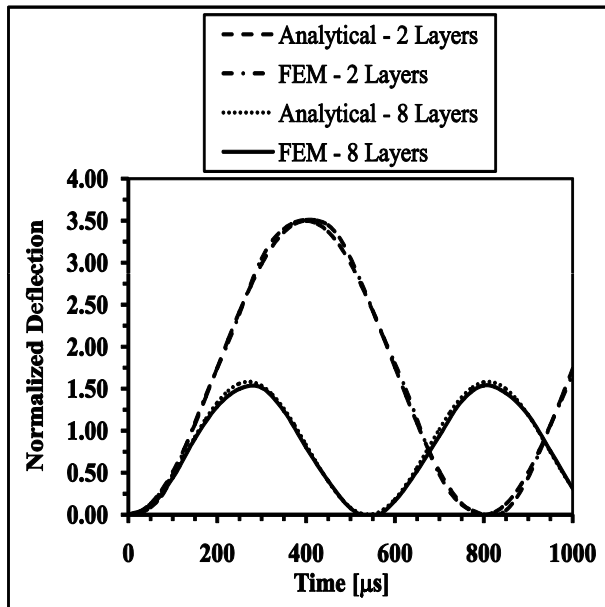

Figure 12. Normalized deflection versus time for (0/90) laminate with $a/h = 25$

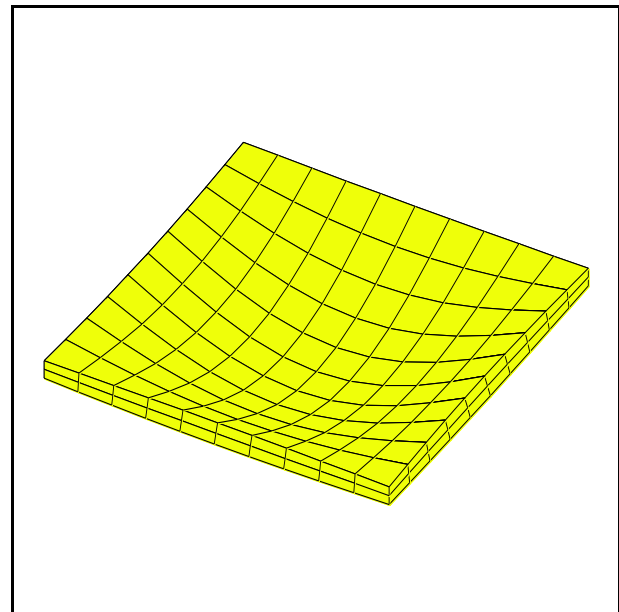

Figure 13. Deformed FE mesh (10×10) of (0/90) laminate with $a/h = 25$

6.5 Results for different forcing functions

Forcing functions, which describe the load change through time, are analyzed in this section. Four different patterns of load change through time are adopted as shown in Figure 14 and in Eq. (28):

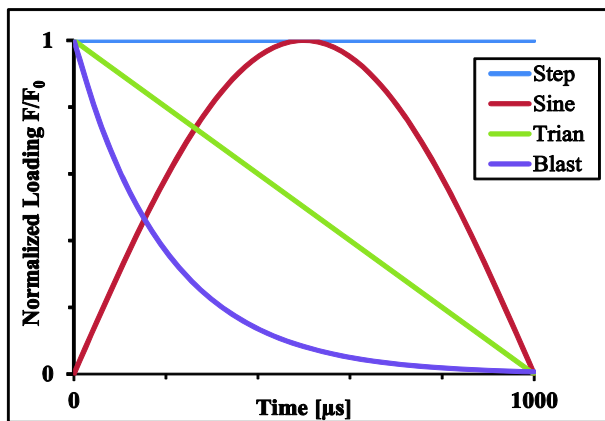

Figure 14. Different forcing functions

Stepped Pulse	$F(t) = F_0$
Sine Pulse	$F(t) = F_0 \sin\left(\frac{\pi \cdot t}{T}\right)$
Triangular Pulse	$F(t) = F_0 \left(1 - \frac{t}{T}\right)$
Blast Pulse	$F(t) = F_0 \cdot e^{-\alpha t}$

(28)

In Eq. (28), F_0 represents the amplitude of the dynamic loading, t is the current time variable, T is the overall time in which loading acts, and α is the damping parameter. For the purpose of this work, $\alpha=0.005$ and $T=1000\mu s$.

The effect of the applied forcing functions on the transient response of laminated plate is investigated using a cross ply (0/90) laminates with $a/h = 10$ and $a = b = 25$ cm. In all cases, uniformly distributed step loading was used. Results are obtained using FEM with 10×10 mesh, for simply supported (SS) and clamped (CC) laminated plate. Figures 15 and 16 illustrate the results of the calculation. Analytical solutions using Fourier series and Convolution Integral for simply supported Mindlin plates are in detail explained in previous work of Hinton, Vuksanović [6]. Also, FE results are given in Hinton, Vuksanović [7]. As stated in [6], triangular pulse is used to simulate a nuclear blast loading. The exponential pulse may be used to simulate a high explosive blast loading. Damping parameter α is adjusted to approximate the pressure curve from the blast test.

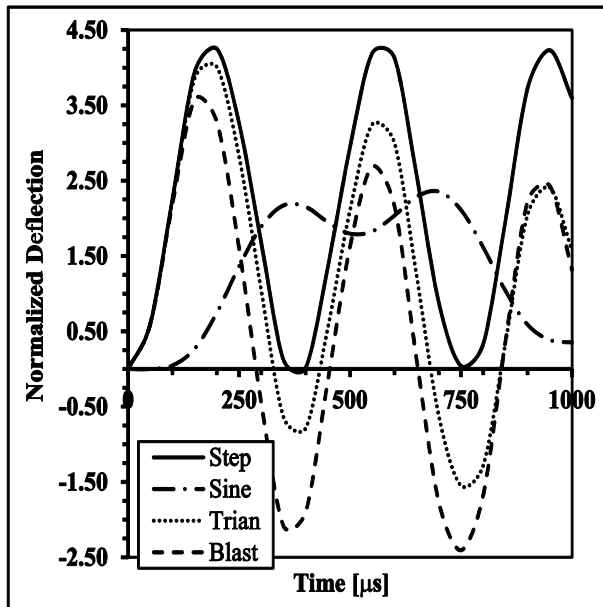

Figure 15. Normalized deflection versus time for (0/90) SS laminate with $a/h = 10$

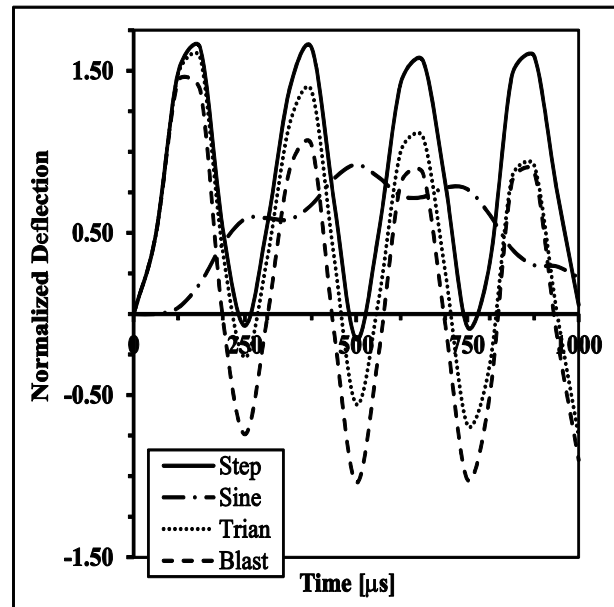

Figure 16. Normalized deflection versus time for (0/90) CC laminate with $a/h = 10$

7. Conclusions

In this paper analytical and FE solutions are presented for linear transient analysis of laminated composite plates. Generalized Laminated Plate Theory is introduced using dynamic version of virtual work principle. Original MATLAB[®] code is applied for obtaining the transient response. Influence of time step length on the solution accuracy was investigated and results for 2 different stacking sequences are presented. It is obvious that larger time step increases the period of oscillation, and reduces the amplitude. Before the further numerical simulations, influence of FE mesh refinement was investigated. Once the convergence was reached, fine mesh was chosen for all following calculations, as shown in examples.

Using the existing examples from the literature, it is shown that using the ESL plate theories, especially for the thick plate problem, underpredicts the amplitudes of oscillation. Stacking sequence affects the plate transient response in a following manner - reduction in a number of laminas through the same overall plate thickness leads to a more flexible plate behavior (increasing the amplitude as well as the period).

Finally, different forcing time functions for uniformly distributed pressure load were applied, and plate response was obtained. These new results are presented for simply supported and clamped cross-ply laminates, with $a/h = 10$. Authors' further research will be aimed to the numerical analysis of laminar composites with the presence of delaminations (natural frequencies, transient response, linear and nonlinear bending and buckling loads). Some investigations are already made in the field of crack propagation, too.

Acknowledgements

The financial support of the Government of the Republic of Serbia - Ministry of Education and Science, under the Project TR-36048, is gratefully acknowledged.

8. References

- [1] Četković M, Vuksanović Đ. Bending, free vibrations and buckling of laminated composite and sandwich plates using a layerwise displacement model. *Composite Structures*, **Vol. 88**, pp. 219–27, 2009.
- [2] Reddy JN. *Mechanics of Laminated Composite Plates: Theory and Analysis*. CRC Press, 1996.
- [3] Vuksanović Đ. Linear analysis of laminated composite plates using single layer higher-order discrete models. *Composite Structures*, **Vol. 48**, pp. 205–11, 2000.
- [4] Reddy JN, Barbero EJ, Teply JL: A plate bending element based on a generalized laminate plate theory, *International Journal for Numerical Methods in Engineering*, **Vol. 28**, pp. 2275-92, 1989.
- [5] Vuksanović Đ, Četković M. Analytical solution for multilayer plates using general layerwise plate theory. *Facta Universitatis*, **Vol. 3**, pp. 121-36, 2005.
- [6] Hinton E, Vuksanović Đ. *Closed form solutions for dynamic analysis of simply supported Mindlin plates*. In: Hinton E, editor: *Numerical Methods and Software for Dynamic Analysis of Plates and Shells*. Swansea, UK: Pineridge Press, 1988, pp. 1-47.
- [7] Hinton E, Vuksanović Đ. *Explicit transient dynamic finite element analysis of initially stressed Mindlin plates*. In: Hinton E, editor: *Numerical Methods and Software for Dynamic Analysis of Plates and Shells*. Swansea, UK: Pineridge Press, 1988, pp. 205-59.
- [8] Marjanović M, Vuksanović Đ. *Linear Transient Analysis of Laminated Composite Plates*. Proceedings of the First international conference for PhD students in Civil Engineering CE-PhD 2012. 4-7.11.2012. Cluj-Napoca, Romania, 2012, pp.169-176.