



PROCEEDINGS OF

International conference on Contemporary
Theory and Practice in Construction XV

Banja Luka, June 16-17, 2022

ЗБОРНИК РАДОВА

Међународне конференције
Савремена теорија и пракса у градитељству XV

Бања Лука, 16-17.06.2022.

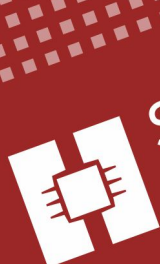

STEPGRAD
СТЕПГРАД

2022



INTERNATIONAL CONFERENCE ON CONTEMPORARY
THEORY AND PRACTICE IN CONSTRUCTION XV

МЕЂУНАРОДНА КОНФЕРЕНЦИЈА
САВРЕМЕНА ТЕОРИЈА И ПРАКСА У ГРАДИТЕЉСТВУ XV

PROCEEDINGS

ЗБОРНИК РАДОВА

Publisher

University of Banja Luka
Faculty of Architecture, Civil Engineering and Geodesy

Издавач
Универзитет у Бањој Луци
Архитектонско-грађевинско-геодетски факултет

On behalf of the publisher

Saša Čvoro, PhD, Associate Professor

За издавача
др Саша Чворо, ванр. професор

Editors

Snježana Maksimović, PhD, Associate Professor
Sandra Kosić-Jeremić, PhD, Associate Professor

Уредници
др Сњежана Максимовић, ванр. професор
др Сандра Косић-Јерemiћ, ванр. професор

DIGITAL PUBLICATION – DISTRIBUTION THROUGH
CONFERENCE WEB SITE

stepgrad.aggf.unibl.org and
doisrpska.nub.rs/index.php/STPG/index

ЕЛЕКТРОНСКО ИЗДАЊЕ – ДИСТРИБУЦИЈА ПУТЕМ
ИНТЕРНЕТ СТРАНИЦЕ КОНФЕРЕНЦИЈЕ:

stepgrad.aggf.unibl.org и
doisrpska.nub.rs/index.php/STPG/index

ISBN

ISSN

Banja Luka, June 2022

978-99976-978-4-4

2566-4484

Бања Лука, јуни 2022.

INTERNATIONAL CONFERENCE ON CONTEMPORARY THEORY AND
PRACTICE IN CONSTRUCTION XV
STEPGRAD XV

МЕЂУНАРОДНА КОНФЕРЕНЦИЈА
САВРЕМЕНА ТЕОРИЈА И ПРАКСА У ГРАДИТЕЉСТВУ XV
СТЕПГРАД XV

PROCEEDINGS

ЗБОРНИК РАДОВА

Ванја Лука, June 16-17, 2022
Бања Лука, 16-17.06.2022.

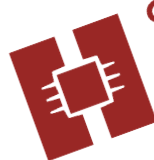

STEPGRAD
СТЕПГРАД

2022

FOREWORD

It is our great pleasure to write this Foreword to the Proceedings of the International Conference on Contemporary Theory and Practice in Construction, XV - STEPGRAD. The Conference was held on June 16 and 17 at the Lanaco Technology Center in Banja Luka. As in previous years, the Conference STEPGRAD XV continues a tradition of bringing together researchers, academics, and professionals from all over the world, experts in Civil Engineering, Architecture, Geodesy, and related fields, so this year it brought participants from fifteen different countries. The Conference enables the interaction of research students, young academics and engineers with the more experienced academic and professional community to present and discuss current accomplishments. Their contributions make these Proceedings outstanding. The published papers provide the most recent scientific and professional knowledge in the fields of Computational mechanics, Structural engineering, Building materials, Road planning, Energy efficiency, Urban planning, Architecture, History of architecture, Surveying, Education of engineers, etc.

Almost eighty manuscripts were submitted, while 70 of them were accepted and categorized. Each contributed paper was refereed by the two reviewers, members of the Scientific Committee. The papers were refereed based on their interest, relevance, innovation, and application to the broad field of Construction. Invited lecturers this year were associate professor Gordana Kaplan, PhD, from the Technical University of Eskisehir in Turkey, associate professor Daniel Lordik, PhD, from the Technical University of Dresden, associate professor Ana Nikezić, PhD, from the University of Belgrade and Filip Niketić, PhD, from the project company Nicolas Fehlmann Ingénieurs Conseils SA in Switzerland.

These Proceedings will furnish the scientists and professionals with an excellent reference book. We are certain it will give an impetus for further studies in all subject areas.

We thank all the authors and reviewers for their valuable contributions. Special thanks go to our sponsors and the members of the Organizational Committee and Working team.

Snježana Maksimović
Sandra Kosić-Jeremić
Editors

ПРЕДГОВОР

Изузетно нам је задовољство написати овај Предговор за Зборник радова са међународне конференције Савремена теорија и пракса у градитељству XV – СТЕПГРАД. Конференција је одржана 16. и 17. јуна у Технолошком центру компаније Ланако у Бањој Луци. Као и претходних година, конференција СТЕПГРАД XV наставља традицију повезивања истраживача, наставника и стручњака из цијелог свијета, експерата грађевинарства, архитектуре, геодезије и сродних области, па је ове године окупила учеснике из петнаест различитих земаља. Конференција је омогућила интеракцију студената, младих инжењера и научника са искуснијим члановима академске и стручне заједнице у циљу дискусије о савременим тенденцијама у градитељству. Њихов допринос је учинио овај Зборник изузетним. Објављени радови пружају увид у актуелно научно и стручно знање из рачунске механике, инжењерских конструкција, грађевинских материјала, саобраћајница, енергетске ефикасности, урбанизма, архитектуре, историје архитектуре, геодезије, образовања инжењера, итд.

Од скоро осамдесет достављених рукописа, 70 је прихваћено и категорисано. Сваки рад је био прегледан од стране два рецензента, члана Научног одбора. Критеријуми за одабир радова су били њихова актуелност, значај и допринос широкој области градитељства. Позивни предавачи ове године били су проф. др Гордана Каплан са Техничког универзитета Ескишехир у Турској, проф. др Даниел Лордик са Техничког универзитета у Дрездену, проф. др Ана Никезић са Универзитета у Београду и др Филип Никетић из пројектне компаније Nicolas Fehlmann Ingénieurs Conseils SA у Швајцарској.

Овај Зборник радова ће послужити као корисна референца стручњацима и истраживачима те смо сигурни да ће пружити подстицај за даљња истраживања у предметним областима.

Захваљујемо свим ауторима и рецензентима на њиховом изузетном доприносу. Посебну захвалност упућујемо нашим спонзорима те свим члановима Организационог одбора и Радног тима.

Сњежана Максимовић
Сандра Косић-Јеремић
уредници

GOLDEN SPONSOR ЗЛАТНИ СПОНЗОР



INTEGRAL
INŽENJERING a.d.

SILVER SPONSORS СРЕБРНИ СПОНЗОРИ



SPONSORS СПОНЗОРИ



ORGANIZER

University of Banja Luka
Faculty of Architecture, Civil
Engineering and Geodesy

ОРГАНИЗАТОР

Универзитет у Бањој Луци
Архитектонско-грађевинско-
геодетски факултет



CO-ORGANISERS

Faculty of Architecture, University of
Belgrade

СУОРГАНИЗАТОРИ

Архитектонски факултет, Универзитет
у Београду



IRMA – Institute for Research in
Materials and Applications, Slovenia

ИРМА – Институт за истраживање
материјала и примјене, Словенија



Faculty of Civil Engineering,
University of Belgrade

Грађевински факултет, Универзитет у
Београду



Faculty of Civil Engineering,
University of Montenegro

Грађевински факултет, Универзитет
Црне Горе



Ss. Cyril and Methodius University in
Skopje

Св. Ћирило и Методије, Универзитет у
Скопљу



University North, Koprivnica

Свеучилиште Сјевер у Вараждину

University of North

Faculty of Civil Engineering and
Architecture, University of Nis

Грађевинско архитектонски факултет,
Универзитет у Нишу



Faculty of Architecture, University of
Montenegro

Архитектонски факултет, Универзитет
Црне Горе



Lanaco – Technology center, Banja
Luka

Ланакo – технолошки центар, Бања
Лука



Hotel Taliya, Banja Luka

Хотел Талија, Бања Лука



Conference director

Assoc. Prof. Snježana Maksimović, PhD

Deputy Conference director

Assoc. Prof. Sandra Kosić-Jeremić, PhD

Директор Конференције

проф. др Сњежана Максимовић

Замјеник директора Конференције

проф. др Сандра Косић-Јеремић

ORGANISING COMMITTEE

Maja Milić-Aleksić, Faculty of Architecture, Civil Engineering and Geodesy, University of Banja Luka, president

Verica Krstić, Faculty of Architecture, University of Belgrade

Jakob Šušteršič, IRMA institute Ljubljana

Slavica Stamatović Vučković, Faculty of Architecture, University of Montenegro

Marina Rakočević, Faculty of Civil Engineering, University of Montenegro

Miroslav Marjanović, Faculty of Civil Engineering, University of Belgrade

Zlatko Srbinoski, Faculty of Civil Engineering, The Ss. Cyril and Methodius University in Skopje

Danko Markovinović, University North, Koprivnica

Branislava Stoiljković, Faculty of Civil Engineering, University of Nis

Anka Starčev-Ćurčin, Faculty of Civil Faculty of Technical Sciences, University of Novi Sad

Vesna Bulatović, Faculty of Technical Sciences, University of Novi Sad

ОРГАНИЗАЦИОНИ ОДБОР

Маја Милић-Алексић, Архитектонско-грађевинско-геодетски факултет, Универзитет у Бањој Луци, предсједник

Верица Крстић, Архитектонски факултет, Универзитет у Београду

Јакоб Шуштершич, ИРМА институт Љубљана
Славица Стаматовић Вучковић, Архитектонски факултет, Универзитет Црне Горе

Марина Ракочевић, Грађевински факултет, Универзитет Црне Горе

Мирослав Марјановић, Грађевински факултет, Универзитет у Београду

Златко Србиноски, Грађевински факултет, Универзитет Св Кирила и Методија у Скопљу

Данко Марковиновић, Свеучилиште Сјевер у Вараждину

Бранислава Стоилковић, Грађевински факултет, Универзитет у Нишу

Анка Старчев-Ћурчин, Факултет техничких наука, Универзитет у Новом Саду

Весна Булатовић, Факултет техничких наука, Универзитет у Новом Саду

SCIENTIFIC COMMITTEE

Prof. dr Biljana Antunović, PhD, University of Banja Luka, chair
Igor Emri, University of Ljubljana
Brankica Milojević, University of Banja Luka
Vladan Đokić, University of Belgrade
Branko Božić, University of Belgrade
Željko Bačić, University of Zagreb
Biljana Šćepanović, University of Montenegro
Aleksandra Krstić-Furundžić, University of Belgrade
Miro Govedarica, University of Novi Sad
Dušan Jovanović, University of Novi Sad
Nađa Kurtović-Folić, University of Novi Sad
Igor Jokanović, University of Novi Sad
Aleksandra Đukić, University of Belgrade
Goran Ćirović, University of Novi Sad
Dragan Lukić, University of Novi Sad
Dragan Milašinović, University of Novi Sad
Aleksandar Borković, University of Banja Luka
Valentina Golubović-Bugariski, University of Banja Luka
Čedomir Zeljković, University of Banja Luka
Sandra Kosić-Jeremić, University of Banja Luka
Malina Čvoro, University of Banja Luka
Maja Ilić, University of Banja Luka
Nevena Novaković, University of Banja Luka
Borislava Blagojević, University of Nis
Snježana Maksimović, University of Banja Luka
Maja Roso Popovac, University Džemal Bijedić of Mostar
Dragan Nikolić, School of Applied Studies for Civil Engineering
and Geodesy, Belgrade
Natalija Bede, University of Rijeka
Aleksandar V. Radević, University of Belgrade
Boško D. Stevanović, University of Belgrade
Saja Kosanović, University of Pristina, Kosovska Mitrovica
Alenka Fikfak, University of Ljubljana
Lucija Ažman Momirski, University of Ljubljana
Mileva S. Samardžić-Petrović, University of Belgrade
Milena Dinić Branković, University of Nis
Ivan Mlinar, University of Zagreb

НАУЧНИ ОДБОР

Проф. др Биљана Антуновић, Универзитет у Бањој Луци,
предсједник
Игор Емри, Универзитет у Љубљани
Бранкица Милојевић, Универзитет у Бањој Луци
Владан Ђокић, Универзитет у Београду
Бранко Божић, Универзитет у Београду
Жељко Бачић, Свеучилиште у Загребу
Биљана Шћепановић, Универзитет Црне Горе
Александра Крстић-Фурунџић, Универзитет у Београду
Миро Говедарица, Универзитет у Новом Саду
Душан Јовановић, Универзитет у Новом Саду
Нађа Куртовић-Фолић, Универзитет у Новом Саду
Игор Јокановић, Универзитет у Новом Саду
Александра Ђукић, Универзитет у Београду
Горан Ћировић, Универзитет у Новом Саду
Драган Лукић, Универзитет у Новом Саду
Драган Милашиновић, Универзитет у Новом Саду
Александар Борковић, Универзитет у Бањој Луци
Валентина Голубовић-Бугарски, Универзитет у Бањој Луци
Чедомир Зељковић, Универзитет у Бањој Луци
Сандра Косић-Јеремић, Универзитет у Бањој Луци
Малина Чворо, Универзитет у Бањој Луци
Маја Илић, Универзитет у Бањој Луци
Невена Новаковић, Универзитет у Бањој Луци
Борислава Благојевић, Универзитет у Нишу
Сњежана Максимовић, Универзитет у Бањој Луци
Маја Росо Поповац, Универзитет Џемал Биједић
Драган Николић, Висока грађевинско-геодетска школа
Београд
Наталија Беде, Свеучилиште у Ријеци
Александар В. Радевић, Универзитет у Београду
Бошко Д. Стевановић, Универзитет у Београду
Саја Косановић, Универзитет у Приштини са привременим
сједиштем у Косовској Митровици
Аленка Фикфак, Универзитет у Љубљани
Луција Ажман Момирски, Универзитет у Љубљани
Милева С. Самарџић-Петровић, Универзитет у Београду
Милена Динић Бранковић, Универзитет у Нишу

Zrinka Barišić Marenčić, University of Zagreb
Lara Slivnik, University of Ljubljana
Juan Luis Rivas Navarro, University of Granada
Jakob Šušteršič, Institute for Research in Materials and Applications, Slovenia
Mila Pucar, Institute of Architecture and Urban & Spatial Planning of Serbia
Petar Gvero, University of Banja Luka
Darija Gajić, University of Banja Luka
Shimaa M. Ahmed, Suez Canal University
Marija T. Nefovska-Danilović, University of Belgrade
Ana Radivojević, University of Belgrade
Aleksandar Savić, University of Belgrade
Miroslav Malinović, University of Banja Luka
Mirjana Malešev, University of Novi Sad
Budimir Sudimac, University of Belgrade
Vlastimir Radonjanin, University of Novi Sad
Vesna Poslončec-Petrić, University of Zagreb
Gordana Kaplan, Eskisehir Technical University
Bojana Grujić, University of Banja Luka
Sanja Tucikešić, University of Banja Luka
Gordana Jakovljević, University of Banja Luka
Ljiljana Teofanov, University of Novi Sad
Dragan Blagojević, University of Belgrade
Radovan Đurović, University of Montenegro
Medžida Mulić, University of Sarajevo
Vlado Cetl, University North, Croatia
Hose Lazaro Amaro Melado, University of Sevilla
Alojz Kopačik, Slovak University of Technology in Bratislava
Oleg Odalović, University of Belgrade
Dragan Pamučar, University of Defence in Belgrade
Žana Topalović, University of Banja Luka
Siniša Vučenović, University of Banja Luka
Sanja Atanasova, Ss. Cyril and Methodius University in Skopje
Diana Stoeva, Acoustics Research Institute, Austrian Academy of Sciences
Vesna Stojaković, University of Novi Sad
Ljubiša Preradović, University of Banja Luka

Иван Млинар, Свеучилиште у Загребу
Зринка Баришић Маренић, Свеучилиште у Загребу
Лара Сливник, Универзитет у Љубљани
Хуан Луис Ривас Наваро, Универзитет у Гранади
Јакоб Шуштершич, Институт за испитивање материјала и примјену, Словенија
Мила Пуцар, Институт за архитектуру и урбанизам, Србија
Петар Гверо, Универзитет у Бањој Луци
Дарија Гајић, Универзитет у Бањој Луци
Шима Махмуд, Универзитет Суецког Канала
Марија Т. Нефовска-Даниловић, Универзитет у Београду
Ана Радивојевић, Универзитет у Београду
Александар Савић, Универзитет у Београду
Мирослав Малиновић, Универзитет у Бањој Луци
Мирјана Малешев, Универзитет у Новом Саду
Будимир Судимац, Универзитет у Београду
Властимир Радоњанин, Универзитет у Новом Саду
Весна Послончец-Петрић, Свеучилиште у Загребу
Гордана Каплан, Технички Универзитет Екскисехир
Бојана Грујић, Универзитет у Бањој Луци
Сања Туцикешић, Универзитет у Бањој Луци
Гордана Јаковљевић, Универзитет у Бањој Луци
Љиљана Теофанов, Универзитет у Новом Саду
Драган Благојевић, Универзитет у Београду
Радован Ђуровић, Универзитет Црне Горе
Меџида Мулић, Универзитет у Сарајеву
Владо Цетл, Свеучилиште Сјевер у Вараждину
Хосе Лазаро Амаро Меладо, Универзитет у Севиљи
Алојз Копачик, Технолошки универзитет Братислава
Олег Одаловић, Универзитет у Београду
Драган Памучар, Војна академија Београд
Жана Топаловић, Универзитет у Бањој Луци
Синиша Вученовић, Универзитет у Бањој Луци
Сања Атанасова, Универзитет "Св. Ћирило и Методије"
Диана Стоева, Технички Универзитет у Бечу
Весна Стојаковић, Универзитет у Новом Саду
Љубиша Прерадовић, Универзитет у Бањој Луци

Gordana Broćeta, University of Banja Luka
Nevenka Antović, University of Montenegro
Branko Milovanović, University of Belgrade
David Polanec, Institute for Research in Materials and Applications, Slovenia
Zlatko Zafirovski, Ss. Cyril and Methodius University in Skopje
Marijana Lazarevska, Ss. Cyril and Methodius University in Skopje
Miroslav Marjanović, University of Belgrade
Tina Dašić, University of Belgrade
Srđa Aleksić, Faculty of Civil Engineering Montenegro
Mirjana Laban, Faculty of Technical Sciences, Novi Sad
Maja Dragišić, Faculty of Architecture, Belgrade
Marko Nikolić, Faculty of Architecture, Belgrade
Danko Markovinović, University of North Varaždin
Svetlana Perović, Faculty of Architecture Montenegro
Vladimir Bojković, Faculty of Architecture Montenegro
Marina Rakočević, Faculty of Civil Engineering Montenegro
Meri Cvetkovska, Ss. Cyril and Methodius University in Skopje
Dragica Jevtić, University of Belgrade
Ljiljana Milić-Marković, University of Banja Luka
Miodrag Regodić, University of Banja Luka
Slaviša Trajković, Faculty of Civil Engineering and Architecture, Niš
Aleksandar Keković, Faculty of Civil Engineering and Architecture, Niš
Miomir Vasov, Faculty of Civil Engineering and Architecture, Niš
Igor Peško, University of Novi Sad, Faculty of Technical Sciences
Slobodan Kolaković, University of Novi Sad, Faculty of Technical Sciences
Jelena Stojanov, University of Novi Sad, Technical faculty "Mihajlo Pupin" Zrenjanin
Ana Nikezić, University of Belgrade, Faculty of Architecture
Zoran Ćurguz, University of East Sarajevo
Anđelko Cumbo, University of Banja Luka

Гордана Броћета, Универзитет у Бањој Луци
Невенка Антовић, Универзитет Црне Горе
Бранко Миловановић, Универзитет у Београду
Давид Поланец, Институт за испитивање материјала и примјену, Словенија
Златко Зафировски, Грађевински факултет Скопље
Маријана Лазаревска, Грађевински факултет Скопље
Мирослав Марјановић, Универзитет у Београду
Тина Дашић, Универзитет у Београду
Срђа Алексић, Грађевински факултет Подгорица
Мирјана Лабан, Факултет техничких наука, Нови Сад
Маја Драгишић, Архитектонски факултет Београд
Марко Николић, Архитектонски факултет Београд
Данко Марковиновић, Свеучилиште Сјевер Вараждин
Светлана Перовић, Архитектонски факултет Подгорица
Владимир Бојковић, Архитектонски факултет Подгорица
Марина Ракочевић, Грађевински факултет Подгорица
Мери Цветковска, Универзитет "Св. Ћирило и Методије", Скопље
Драгица Јевтић, Универзитет у Београду
Љиљана Милић-Марковић, Универзитет у Бањој Луци
Миодраг Регодић, Универзитет у Бањој Луци
Славиша Трајковић, Грађевинско-архитектонски факултет Ниш
Александар Кековић, Грађевинско-архитектонски факултет Ниш
Миомир Васов, Грађевинско-архитектонски факултет Ниш
Игор Пешко, Факултет техничких наука, Универзитет у Новом Саду
Слободан Колаковић, Факултет техничких наука, Универзитет у Новом Саду
Јелена Стојанов, Технички факултет "Михајло Пупин" Зрењанин, Универзитет у Новом Саду
Ана Никезић, Архитектонски факултет, Универзитет у Београду
Зоран Ћургуз, Универзитет у Источном Сарајеву
Анђелко Цумбо, Универзитет у Бањој Луци

УРЕДНИЦИ

проф. др Сњежана Максимовић
проф. др Сандра Косић-Јеремић

УРЕЂИВАЧКИ ОДБОР

доц. др Маја Илић
доц. др Бојана Грујић
доц. др Сања Туцикешић

Огњен Мијатовић, веб администратор
Ђорђе Стојисављевић, веб администратор
Драгана Зељић, технички администратор
Дајана Папаз, технички уредник
Драгана Скоруп, графички уредник
Јелена Пажин, лектор

ИЗВРШНИ ОРГАНИЗАЦИОНИ ОДБОР

доц. др Гордана Броћета
проф. др Малина Чворо
проф. др Дарија Гајић

EDITORS

Assoc. Prof. Snježana Maksimović, PhD
Assoc. Prof. Sandra Kosić-Jeremić, PhD

EDITORIAL COMMITTEE

Assist. Prof. Maja Ilić, PhD
Assist. Prof. Bojana Grujić, PhD
Assist. Prof. Sanja Tucikešić, PhD

Ognjen Mijatović, web administrator
Đorđe Stojisavljević, web administrator
Dragana Zeljić, technical administrator
Dajana Papaz, technical editor
Dragana Skorup, graphic editor
Jelena Pažin, proofreader

EXECUTIVE ORGANIZATIONAL COMMITTEE

Assist. Prof. Gordana Broćeta, PhD
Assoc. Prof. Malina Čvoro, PhD
Assoc. Prof. Darija Gajić, PhD

CONTENT САДРЖАЈ

- 001-010 ON THE SELECTION OF A SUITABLE CONCRETE
Filip Niketić
- 011-020 CONSTRUCTION OF SKEW RULED SURFACES BY MANIPULATING CONTROL LINES
Daniel Lordick
- 021-027 EVALUATING MACHINE LEARNING MODELS FOR SOIL SALINITY ESTIMATION USING SATELLITE IMAGERY
Uğur Avdan, Gordana Kaplan, Dilek Matci, Firat Erden, Zehra Yigit Avdan, Ece Mizik
- 028-044 RESISTANCE TO CRACK PROPAGATION OF HIGH-PERFORMANCE CONCRETE
Jakob Šušteršič, Rok Ercegovič, David Polanec
- 045-052 THE INFLUENCE OF CONCRETE VISCOUS DEFORMATIONS DURING BEHAVIOR CALCULATION OF CABLE-STAYED BRIDGES
Anđelko Cumbo, Gordana Bročeta, Marina Latinović Krndija, Mladen Sljepčević, Žarko Lazić
- 053-062 THE EFFECT OF THERMAL TREATMENT ON MECHANICAL AND DEFORMATION PROPERTIES OF STEEL REINFORCEMENT
Marija Mirković, Aleksandar Radević, Dimitrije Zakić, Aleksandar Savić, Marina Askrabić, Dragica Jevtić
- 063-072 EXPERIMENTAL INVESTIGATION OF SCC WITH RECYCLED RUBBER AND RECYCLED CONCRETE AGGREGATE
Marko Popović, Aleksandar Savić, Gordana Bročeta, Branko Borozan, Mihailo Štavljanin
- 073-082 MULTI-CRITERIA ANALYSIS OF COMPROMISE ROAD ALIGNMENT SOLUTION FOR ROUTE 2A - SECTION KRUPA TO BOČAC
Draženko Glavić, Marina Milenković, Dragan Topić
- 083-091 PRELIMINARY QUANTITY ESTIMATION IN CONSTRUCTION USING MACHINE LEARNING METHODS
Nevena Simić, Predrag Petronijević, Aleksandar Devedžić, Marija Ivanović
- 092-103 MODEL OF POROUS MATERIALS BY RHEOLOGICAL-DYNAMICAL ANALOGY USING THE PRINCIPLES OF MASS AND ENERGY CONSERVATION
Dragan Milašinović, Danica Goleš, Andrea Rožnjik, Nataša Mrđa Bošnjak
- 104-111 ISOGEOMETRIC ANALYSIS OF A SPATIALLY CURVED BERNOULLI-EULER BEAM SUBJECTED TO MOVING LOAD
Miloš Jočković, Marija Nefovska-Danilović, Aleksandar Borković
- 112-125 FREE VIBRATION ANALYSIS OF SINGLY CURVED CLAMPED SHELLS USING THE ISOGEOMETRIC FINITE STRIP METHOD
Aleksandar Borković, Dijana Majstorović, Snježana Milovanović, Duy Vo
- 126-141 SETTING THE REAL-TIME FLOOD FORECASTING MODELS IN UNGAUGED BASINS
Žana Topalović, Nikola Rosić, Job Udo
- 142-152 COMPARATIVE ANALYSIS OF AN UNGAUGED BASIN MODELLING RESULTS BY THREE CONCEPTUAL HYDROLOGICAL MODELS
Borislava Blagojević, Žana Topalović, Petar Praštalo

- 153-159 ANALYSIS AND EVALUATION OF THE THERMOPHYSICAL PROPERTIES OF VENTILATED FACADE TYPOLOGIES
Georgios Chantzis, Maria Symeonidou, Panagiota Antoniadou, Effrosyni Giama, Sofia-Natalia Boemi, Stella Chadiarakou
- 160-169 ENERGY-EFFICIENT REFURBISHMENT OF MUNICIPAL PUBLIC BUILDINGS IN BELGRADE, SERBIA
Nikola Miletić, Dušan Ignjatović, Bojana Zevković, Nataša Ćuković Ignjatović
- 170-180 ENERGY AND ECONOMIC ANALYSIS OF THE RENOVATION OF THE KINDERGARTEN IN BANJA LUKA ACCORDING TO THE CURRENT RULEBOOK AND NZEB
Darija Gajić, Saša Zečević, Milovan Kotur, Aleksandar Janković
- 181-190 IMPACT OF DESCRIPTIVE GEOMETRY ON THE IMPROVEMENT OF SPATIAL ABILITIES OF ARCHITECTURE STUDENTS
Dajana Papaz, Sandra Kosić-Jeremić, Maja Ilić
- 191-204 ANALYSIS AND PREDICTION OF SPATIOTEMPORAL CHANGES OF URBAN AREAS USING NEURAL NETWORKS
Milan Gavrilović, Igor Ruskovski, Dubravka Sladić, Aleksandra Radulović, Miro Govedarica, Dušan Jovanović
- 205-218 IMPROVEMENT OF THE URBAN GREEN MATRIX THROUGH URBAN REGULATION AND ARRANGEMENT OF UNDEVELOPED SPACES - CASE STUDY OF LAUSH SETTLEMENT IN BANJALUKA
Tanja Trkulja, Ljiljana Došenović, Nataša Rodić
- 219-233 LINEAR LANDSCAPE. THE IDEA OF ACTIVATION THE OLD ROAD BANJA LUKA - ČELINAC AS NARRATIVE ITINERARY
Malina Čvoro, Juan Luis Rivas Navarro, Igor Kuvač
- 234-245 SHRINKING RURAL AREAS OF REPUBLIC OF SRPSKA
Tijana Vujičić
- 246-255 COLLECTIVE HOUSING FORM IN CONTEXT OF DISPERSED CITY: BANJA LUKA CASE STUDY
Anita Milaković, Nevena Novaković
- 256-266 NEIDHARDT'S VERNACULAR-MODERNIST GLOSSARY OF BOSNIA AND HERZEGOVINA'S ARCHITECTURE AND URBANISM
Dijana Simonović
- 267-273 POSSIBILITY OF USING SENTINEL RADAR SATELLITE IMAGES
Miroslav Vujanović, Dragana Skorup
- 274-282 IPHONE 13 PRO VS PROFESSIONAL TLS FOR 3D INDOOR MAPPING
Gordana Jakovljević, Miro Govedarica, Flor Alvarez Taboada
- 283-293 COMPARISON OF IRI-2016 AND NEQUICK MODELS OF THE IONOSPHERE OVER THE BALKAN PENINSULA DURING THE YEAR 2019
Miljana Todorović Drakul, Sanja Grekulović, Oleg Odalović, Dušan Petković
- 294-304 MOBILE LASER SCANNING FOR DETAILED DIGITAL TOPOGRAPHIC MAPPING
Slavica Ilijević, Stefan Miljković, Željko Cvijetinović, Mileva Samardžić-Petrović
- 305-319 DESIGNING OF CONTINUOUS DAM MONITORING USING GLOBAL NAVIGATION SATELLITE SYSTEMS
Slavko Vasiljević, Branko Milovanović

- 320-325 GEOIDS AS TWO-DIMENSIONAL HYPERSURFACES
Mirjana Miljević, Asahi Tsuchida
- 326-333 GENDER DIFFERENTIATION OR EQUALITY IN TRANSPORT PROJECTS: CASE STUDY ROAD SECTOR MODERNIZATION IN THE FEDERATION OF BOSNIA AND HERZEGOVINA
Igor Jokanović, Selma Ljubijankić
- 334-340 GENDER DIFFERENCES IN THE ACHIEVEMENTS OF CIVIL ENGINEERING STUDENTS
Ljubiša Preradović, Sandra Kosić-Jeremić, Snježana Maksimović, Miroslav Malinović, Đorđe Stojisavljević
- 341-351 EDUCATION OF ARCHITECTURAL ENGINEERS IN SERBIA FOR THE SUSTAINABLE DEVELOPMENT MODEL
Marija Mihajlović, Ljiljana Stošić Mihajlović
- 352-360 COMPATIBILITY OF EU AND SERBIAN ENERGY POLICIES WITH SPECIAL REFERENCE TO BUILDINGS
Ljiljana Stošić Mihajlović, Marija Mihajlović
- 361-370 ENERGY EFFICIENCY IMPROVEMENTS OF THE BUILDING STOCK: REPUBLIC OF SERBIA LEGISLATION COMPLIANCE TO THE EUROPEAN UNION
Jelena Pavlović, Ana Šabanović, Nataša Ćuković Ignjatović
- 371-379 RADON SOURCES AND ACTION LEVELS
Jelena Rašović, Biljana Antunović
- 380-392 ENERGY RENOVATION OF RESIDENTIAL BUILDING ENVELOPE USING ORGANIC MATERIALS FOR THE LEVEL OF COST-OPTIMAL IMPROVEMENT/ UPGRADE IN BOSNIA-HERZEGOVINA AND SERBIA
Budimir Sudimac, Darija Gajjić, Slobodan Peulić
- 393-399 AN EXAMINATION OF THE IMPACT OF THE SPATIAL LAYOUT OF MARKET STALLS ON THE QUALITY OF THEIR VISIBILITY USING ISOVIST FIELD: A COMPARATIVE ANALYSIS
Tanja Mitrović, Vesna Stojaković, Milica Vračarić
- 400-408 SPATIAL-FUNCTIONAL DEVELOPMENT OF SALON APARTMENT IN SERBIA
Vladana Petrović, Nataša Petković Grozdanović, Hristina Krstić, Branislava Stoiljković, Milica Živković
- 409-418 SPATIAL ARRANGMENT OF MULTIFAMILY SOCIAL HOUSING – KEY CRITERIA RELEVANT FOR THE QUALITY OF HOUSING
Nataša Petković Grozdanović, Branislava Stoiljković, Slaviša Kondić, Katarina Medar
- 419-434 SMALL URBAN STREAMS IN ENHANCING CITY RESILIENCE – THEORETICAL PERSPECTIVE AND THE POSSIBILITIES OF USE IN THE CITY OF NIŠ, SERBIA
Milena Dinić Branković, Jelena Đekić, Milica Igić, Milica Marković
- 435-447 APPLICATION OF THE PRINCIPLES OF INTEGRATED PLANNING IN URBAN PLAN OF BANJALUKA 2020-2040 WITH FOCUS ON SUSTAINABLE USE OF NATURAL RESOURCES
Brankica Milojević
- 448-456 ARCHITECTURE AND TECHNOLOGIES AT THE TURN OF THE CENTURY: Understanding and translation of historical material
Saša Čvoro, Malina Čvoro, Una Okilj

- 457-465 MAN AND SPACE OF EXCHANGE - STRATEGIES AND TACTICS FOR DESIGNING A MARKETPLACE AS A PLACE FOR EVERYDAY ACTIVITIES
Diana Stupar, Jelena Stanković, Ivan Živanović
- 466-475 CCULTURE OF MEMORY AND HERITAGE AS A STRONG CONNECTION – A CASE OF MONASTERY OF THE HOLY ARCHANGELS IN PRIZREN
Jasna Guzijan, Siniša Cvijić
- 476-486 USER NEEDS ASSESSMENT FOR THE ESTABLISHMENT OF SPATIAL DATA INFRASTRUCTURE OF CELESTIAL BODIES
Zvonimir Nevistić, Željko Bačić
- 487-497 INFLUENCE OF MATERIAL SURFACE ROUGHNESS ON BACKSCATTERING IN LASER SCANNING
Anastasija Martinenko, Ljiljana Brajović, Miodrag Malović
- 498-510 MONITORING OF SECURITY OF AGRICULTURAL CROPS WITH MINERAL MATERIALS BY REMOTE DETECTION METHOD
Mladen Amović, Ivana Janković
- 511-520 3D LASER SCANNING FOR RECONSTRUCTION AND RENOVATION OF BUILDINGS
Danko Markovinović, Dorotea Lovrenčić, Sanja Šamanović, Vlado Cetl
- 521-529 ASSESSMENT OF THE POSITIONAL ACCURACY OF THE TOPOGRAPHIC MAP 1:50.000 MADE BY MGI
Stevan Radojčić
- 530-539 USING OF LOW COST MOISTURE SENSORS IN HYDROTECHNICS TEACHING
Petar Praštalo, Ljiljana Brajović, Dušan Prodanović
- 540-551 DYNAMIC AMPLIFICATION FACTOR OF ROAD BRIDGES – ANALYTICAL AND EXPERIMENTAL FINDINGS
Marina Latinović Krndija, Dejana Dujaković, Marko Popović, Gordana Broćeta, Anđelko Cumbo
- 552-558 DETERMINATION OF VENTILATION HEAT LOSSES THROUGH BUILDING ENVELOPE – A CASE STUDY
Snežana Ilić, Mirjana Malešev, Milica Mirković Marjanović, Aleksandar Kijanović
- 559-567 THE HEAT BALANCE FOR EXTERNAL COMPOSITE WALLS
Siniša Vučenović, Nataša Šetrajčić, Nikola Vojnović, Jovan Šetrajčić, Snježana Dupljanin
- 568-579 THE INFLUENCE OF A REGULATED CITY COAST ON THE QUALITY OF LIFE IN THE CITY OF BRČKO
Slobodan Bulatović
- 580-591 HOUSING NATURE, REPRESENTING »NATURE«: ARCHITECTURE OF CONSERVATORIES, GREENHOUSES AND THEIR TRANS-PROGRAMMATIC SCIONS
Ognjen Šukalo, Maja Milić Aleksić, Slobodan Peulić
- 592-599 ANALYSIS OF DYNAMIC LOAD OF SIMPLE BEAMS USING GEODETIC AND GEOTECHNICAL SENSORS IN LABORATORY CONDITIONS
Milka Šarkanović Bugarinović, Aleksandar Ristić, Željko Bugarinović, Milan Vrtunski, Dušan Jovanović

- 600-607 CONTROL OF SUBSTRUCTURE CONSTRUCTION OF RAILWAYS IN THE REPUBLIC OF SERBIA
Dragan Lukić, Dragoslav Rakić, Irena Bašarić Ikodinović
- 608-612 COMPARATIVE ANALYSIS OF EXCAVATION AND TUNNEL SOLUTIONS FOR THE ROAD DRENOVO - RAEC
Vasko Gacevski, Riste Ristov, Ivona Nedevska, Zlatko Zafirovski, Slobodan Ognjenović
- 613-624 CRANE GIRDER DESIGN ACCORDING TO EUROCODE – NUMERICAL EXAMPLE OF A CRANE GIRDER IN A HYDROPOWER PLANT
Radovan Vukomanović, Slobodan Popadić, Srježana Milovanović
- 625-634 USING AND MODELING GROUND PENETRATING RADAR ON DENSELY REINFORCED SLABS
Dragan Nikolić, Dragan Bajović, Goran Ćirović
- 635-642 ANALYSIS AND EXPERIMENTAL TESTING OF PHYSICAL AND MECHANICAL PROPERTIES OF FLOORING EPOXY
Milan Prokopić, Aleksandar Savić, Stefan Marjanović, Predrag Petronijević
- 643-652 THE AMBIVALENCE OF SPACE IN HOUSING ARCHITECTURE AS A RESULT OF LAYERED ARCHITECTONIC STRUCTURE
Hristina Krstić, Vladana Petrović, Milica Živković, Slaviša Kondić, Katarina Medar
- 653-658 AESTHETIC CONTRASTS OF CONTEMPORARY URBAN ARCHITECTURE: RARE HIGH ACHIEVEMENTS AND PREVAILING WANDERING
Aleksandar Videnović, Miloš Arandjelović
- 659-667 ANALYSIS OF REVITALIZATION AND CONVERSION OF CULTURAL AND HISTORICAL SITES ON THE EXAMPLE OF RENZO PIANO BUILDING WORKSHOP-PATHE FOUNDATION
Jovana Vukanić
- 668-679 GEOMATIC DATA FOR HISTORIC BUILDINGS. THE CASE STUDY OF THE CATHOLIC CHURCH OF ST. LUKE IN ATHENS, GREECE
Charikleia Pagouni, Nenad Nikolić, Thanos Iliodromitis, Vassilis Pagounis, Saja Kosanović, Maria Tsakiri
- 680-686 3D MODELS BASED ON UAV IMAGES AND GPS TECHNOLOGY IN THE FIELDS OF ARCHITECTURE, CIVIL ENGINEERING, SPATIAL PLANNING AND ENERGETICS
Stefan Jovanović, Sanja Tucikešić
- 687-697 PROCEDURE FOR PREPARATION OF TECHNICAL DOCUMENTATION FOR REGISTRATION OF CONDOMINIUM OWNERSHIP
Vinko Šutalo, Dragan Macanović, Dragana Skorup
- 698-708 ГЕОДЕТСКИ РАДОВИ НА ИЗГРАДЊИ ТУНЕЛА МРКЕ У КОНТЕКСТУ ТЕХНОЛОГИЈЕ ИЗВОЂЕЊА РАДОВА И ГЕОМОРФОЛОШКИХ УСЛОВА
Radovan Đurović, Ivan Mrdak, Gojko Nikolić, Zoran Sušić, Marko Marković
- 709-715 ГЕОДЕТСКА КОНТРОЛА ГЕОМЕТРИЈЕ ИНЖЕЊЕРСКОГ ОБЈЕКТА У ТОКУ ИЗГРАДЊЕ – СТУДИЈА СЛУЧАЈА СТАМБЕНО-ПОСЛОВНИ ОБЈЕКАТ У СРПЦУ
Vladan Janković, Slavko Vasiljević, Branko Božić

CONFERENCE PAPERS

РАДОВИ КОНФЕРЕНЦИЈЕ



**STEPGRAD
СТЕПГРАД**

2022

01

Review paper I Прегледни научни рад
DOI 10.7251/STP2215001N
ISSN 2566-4484



Filip Niketić, Nicolas Fehlmann Ingénieurs Conseils SA, filip.niketic@gmail.com

ON THE SELECTION OF A SUITABLE CONCRETE

Abstract

This paper aims to analyze the carbon footprint which the construction industry leaves on the global GHG emissions. It focuses on understanding the sources of the embodied carbon in each stage of the structure's lifecycle. It also explores the ways of reducing the CO₂ costs, focusing primarily on the RC structures. A comparative analysis of different types of cement as well as their corresponding carbon signature is performed and explored. Finally, the ecological benefits of the appropriate concrete and cement selection are presented through real-life examples.

Keywords: Construction industry, carbon footprint, CO₂ emission, concrete, cement

О ОДАБИРУ АДЕКВАТНОГ БЕТОНА

Сажетак

Циљ овог рада је анализа количине угљен-диоксида који грађевинска индустрија ослобађа у оквиру глобалне емисије штетних гасова. Рад се фокусира на разумевање извора поменутог угљеника у свакој фази животног циклуса конструкције. Такође истражује начине смањења CO₂, концентришући се првенствено на бетонске конструкције. Врши се и компаративна анализа различитих типова цемента и поређење њиховог утицај на животну средину. Еколошке предности одређених врста бетона и цемента су представљене кроз примере из стварног живота.

Кључне ријечи: Грађевинска индустрија, штетни гасови, угљен-диоксид, бетон, цемент

1. INTRODUCTION

During the United Nations Climate Change Conference held in Paris in 2015, 196 countries agreed to undertake an ambitious goal to keep the average rise of the global temperature below 2°C, in order to reduce the negative effects of the climate change. In 2021 the world witnessed massive floods in Germany and Belgium, as well as the spreading of major wildfires in Turkey and Greece; both disasters serving as reminders of what our future might look like unless immediate action is taken. The Joint Research Center, part of the European Commission, has published in 2021 an extensive rapport on the Greenhouse gases (GHG) emissions involving 213 world's countries [5]. Based on this report we see an overall reduction in CO₂ since 2019, but further efforts need to take place so that the ambitious goal of “Net Zero carbon by 2050” can be archived (refer to Fig.1).

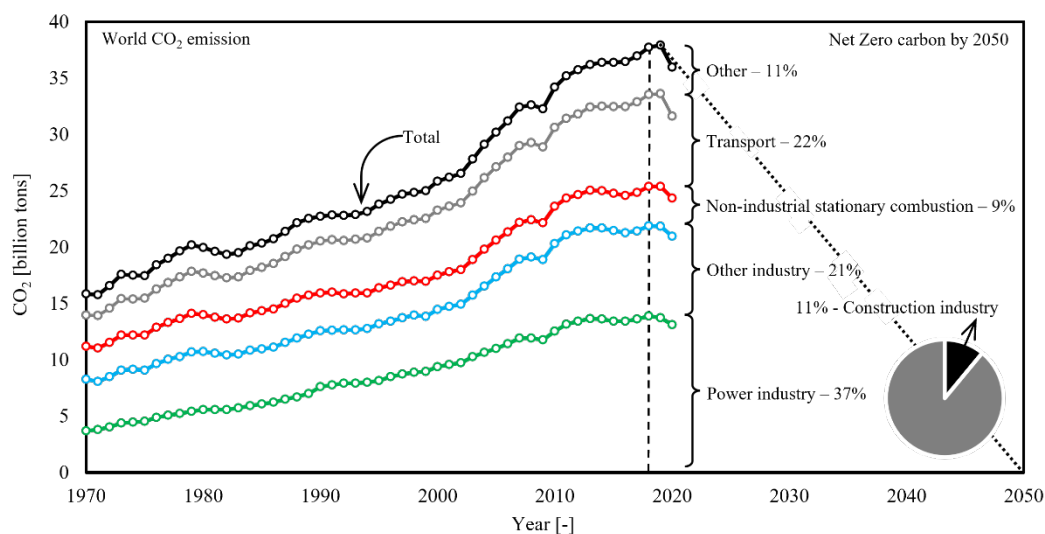

Figure 1. Annual CO₂ emissions over the past 50 years per sector

Looking at the Fig.1, one can observe that the first major contributor to the CO₂ emission is the industry sector which makes up for 58%, power industry being the leader of the sector with the participation of 37%. The second major contributor is the transport sector that accounting for 22% of the global carbon emission, followed by the non-industrial stationary combustion units often found in residential buildings that contribute with 9% of annual CO₂. Remaining 11% are added by the other industrial processing emissions involving non-metallic minerals, non-ferrous metals, solvents and chemicals, agricultural soils and waste.

Focusing on the construction sector, according to the UN environment program [6], it represents 11% of the total CO₂ emission (in Fig.1 it is accounted for under the “other industry” category). This sector is defined as an estimate of the overall production of the building materials such as cement, steel, bricks and glass. Thus, the construction sector becomes the 3rd world's major pollutants; bringing a great responsibility to the engineers and the architects alike, to take a more proactive role in this great challenge of our generation.

Transport of the raw components (steel, aggregates and cement), as well as the building materials (re-bars and fresh concrete), translates into additional CO₂ that is directly related to the construction industry. Providing the structures with heating, ventilation, suage and electricity broadens the carbon footprint even further,-the initial 11% of the annual CO₂ caused directly by the construction sector, is bumped to 39% according to the UN environment program [6].

Putting the emphasis on the carbon footprint of the construction industry is one of the objectives of this paper. It also aims to analyze the structure's emissions from the perspective of its lifecycle, as well as to offer recommendations on how these emissions can be reduced through a critical material selection, focusing primarily on the concrete structures.

2. LIFECYCLE AND CO₂

As a response to the Net Zero 2050 policy, organizations such as The Institution of Structural Engineers (UK) and London Energy Transformation Initiative (UK) have published design guidelines [7,11], which provide the engineers and the architects with a better overall understanding

of how much embedded carbon is induced throughout each of the following stages of structure's lifecycle (refer to Fig.2):

- Products/materials phase (indicated in black in Fig.2)
- Constructing phase (indicated in gray in Fig.2)
- Exploitation/usage phase (indicated in red in Fig.2)
- End of life (indicated in white in Fig.2).

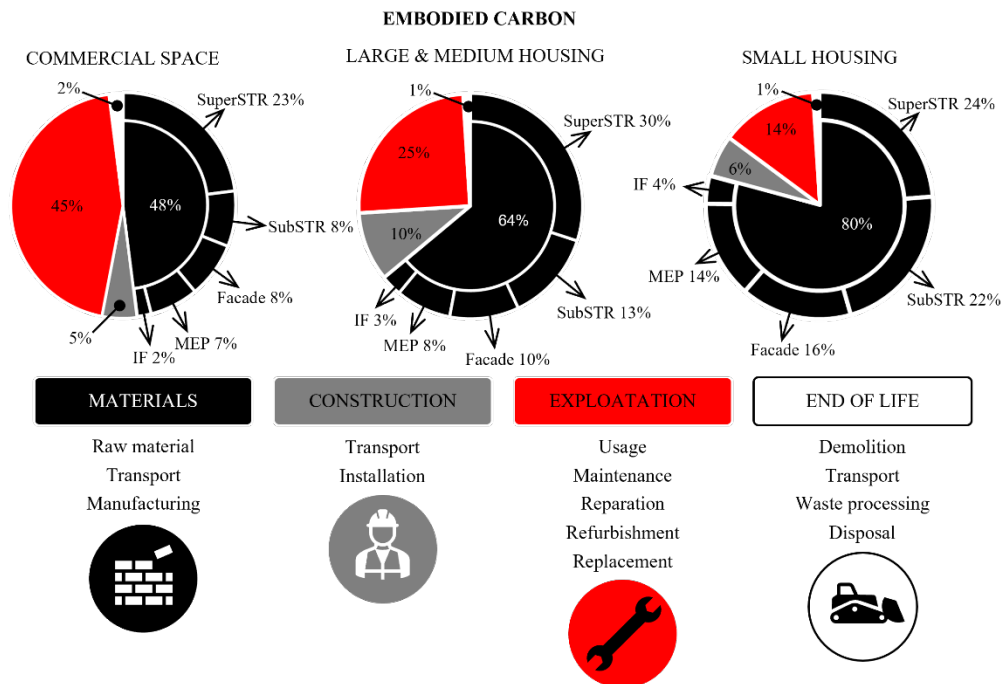

Figure 2. Amount of embodied carbon in commercial and residential buildings induced in different stages of the structure's lifecycle

As seen in Fig.2 the carbon footprint of each stage depends on the type of the project. It is therefore more important to focus on the optimization of the exploitation stage of commercial buildings (where it contributes with 45% of the total CO₂) than it is on the small residential buildings (where it represents—only 14%). Material optimization on the other hand is something which should constantly be underlined, as it participates with 80%, 64% and 48% for the small, large & medium housing units and the commercial spaces respectively. Building more with less has historically always been a challenge of the construction industry, principally governed by the economic reasons. Today it is even more relevant due to the added ecological criteria.

Looking closer at the material/product phase, one can distinguish between the CO₂ emissions related to the:

- Superstructure (SuperSTR) – the load carrying part of the building
- Substructure (SubSTR) – the non-load carrying part of the building
- Façade
- Mechanical, electrical and plumbing (MEP)
- Internal finishes (IF)

Design of the superstructure is the main responsibility of civil engineers, and it alone uses up to 30% of the total embodied carbon over the entire lifespan of a building (refer to Fig. 2). Combining this with the data from Fig.1, means that at least 2.5 % of the entire world's CO₂ emission is directly dependent on the work of civil engineers and architects. Therefore, if the objective of the construction sector is to set a benchmark for the other industries in reducing its carbon footprint, then reducing the spans whenever possible, avoiding the structural misalignments, and designing foundations based on non-conservative geotechnical reports should be the way for the future building [14,15]. Engineers should be included from the beginning in the decision-making process, in order to find a good compromise between the architectural expression and the environmentally responsible structure.

3. SELECTING THE ECOLOGICALLY RESPONSIBLE CEMENT

Let's focus on the material whose application in construction industry can hardly be overlooked: the Reinforced Concrete (RC). Almost every modern structure created in the 20th century, uses RC for its foundations, if not for the entire superstructure, substructure, and facade. Combining high compressive resistance with workability, durability, unique aesthetics, and an affordable price, has helped reinforced concrete remain the most produced man-made material in the world, being second in use to water [3,7].

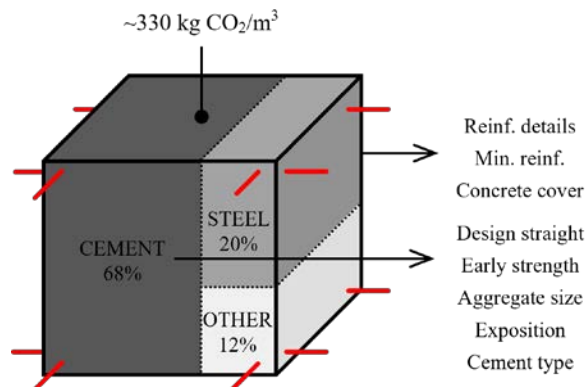

Figure 3. Amount of embodied CO₂ in 1m³ of reinforced concrete (type NPKC) with CEM I cement and 100 kg/m³ of reinforcement

Fig.3 shows a breakdown of the embodied carbon in 1m³ of RC type C30/37 that uses 300 kg of CEM I cement and 100 kg of reinforcement. The vast majority (68%) of emitted CO₂ is associated with the cement, additional 20% are related to the reinforcement and the remaining 12% are divided between the aggregate, water consumption and the energy required to mix the components.

If one's goal is to reduce the amount of emitted carbon of RC, their efforts should focus on:

- Choosing the type of the cement that is being used
- Choosing the minimal necessary design and early concrete strength,
- Choosing concrete based on its exposure,
- Putting the minimal reinforcement that corresponds to the exploitation of the element in question,
- Minimizing the amount of reinforcement through accurate calculation,
- Minimizing the concrete cover in order to increase the lever arm,
- Maximizing the aggregate size in order to gain maximal shear resistance.

Even though all the points mentioned above can be discussed in detail, this article will focus solely on the two points: the selection of the concrete based on its exposure and the impact of the cement type on the overall amount of the embodied carbon in RC.

These two parameters, which are perhaps the most overlooked by the structural engineers in practice, are some of the most important ones when it comes to the Net Zero carbon policy. The carbon emissions of cement mainly come from the production of Portland Cement (PC) clinker. The total amount of the carbon embodied in PC clinker comprises approximately of [8]:

- 10% of CO₂ related to the kiln operations,
- 40% of CO₂ related that are thermal energy,
- 50% associated with the chemical decomposition of limestone (CaCO₃) into lime (CaO), the process that chemically releases the CO₂.

Even though it is possible to reduce the carbon associated with kiln operations and substitute fuel in the thermal energy to favor more green options; the release of CO₂ cannot be avoided in the production of the clinker.

Tab.1 summarizes the types of cement that are being used for the construction of residential and non-residential buildings.

Tab.1: Types of cement used in buildings according to SN EN 197-1

Type	Notation	PC clinker [%]	Primary constituents* [%]	Secondary constituents** [%]
CEM I	CEM I	95-100	-	0-5
CEM II	CEM II/A	80-94	6-20	0-5
	CEM II/B	65-79	21-35	0-5
Special	CEM ZN/D***	50-64	36-50	0-5

* Silica fume / natural pozzolan / calcified natural pozzolan / silica fly ash / calcium fly ash / calcined shale / limestone

** Secondary constituents of cement

*** Developed by HOLCIM

There are 2 basic types of cement (CEM I and CEM II), whose type and composition of the primary as well as the secondary constituents are directly given by the norm SN EN 197-1 [10]. The main difference between the CEM I and the CEM II cement is that the first one consists almost entirely of PC clinker, whereas the second one employs a specific percentage of the primary constituents, thus lowering the amount of PC clinker in the mix. Depending on the quantity of these constituents, CEM II can be categorized as CEM II/A or CEM II/B. CEM ZN/D, is a special (non-standard) cement whose type of primary and secondary constituents is governed by the norm SN EN 197-1 [10], but their composition is not. Compared to the previous two types, CEM ZN/D has even a lower content of PC clinker and has been developed with the Net Zero carbon policy in mind.

There is a number of products that can be used to substitute the PC clinker, some of them being silica fume, silica fly ash and calcium fly ash. These products are classified as industrial waste, and as such their carbon footprint has already been made. Therefore, replacing the PC clinker with the industrial waste lowers the amount of the emitted CO₂.

Regarding the strength of cement types indicated in Tab.1, both CEM I and CEM II exist in all three strength classes (32.5, 42.5 and 52.5). CEM ZN/D however can only be ordered with the strength of 32.5 and 42.5 [10].

This article focuses primarily on concrete used for the construction of residential and non-residential buildings, which does not require the application of the highest cement strength class. In order to have a direct comparison of the emitted CO₂ related to different types of concrete, all the recipes considered in the following chapter assume 42.5 cement strength class.

4. SELECTING THE ECOLOGICALLY RESPONSIBLE CONCRETE

Tab.2 shows 3 most used types of concrete in the building industry: NPKA, NPKB and NPKC [12]. These mixtures have different design strength, various exposure classes and cement quantities. According to SN EN 206 [9], NPKA and NPKB types of concrete can be used for all internal RC elements. NPKC however should be used for the elements that are exposed to atmospheric influence as well as the elements that are in direct contact with the soil. Choosing the correct concrete for a specific element directly influences the amount of used cement and choosing the right cement directly influences the amount of embodied carbon. There is however a matter of price which varies very little between NPKA, NPKB and NPKC concrete. If the costs are almost the same, then why choose a less resistant material? Why complicate the execution of the project by having to change concrete type for each element? The answer to these questions is simple: in order to help the climate.

Tab 2: Type of concrete SN EN 206			
Type	NPK A	NPK B	NPK C
Design strength	C20/25	C25/30	C30/37
Exposition class	XC1, XC2	XC3	XC4, XF1

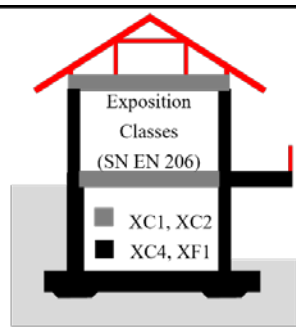

The aggregates that can be used in the concrete production are made from natural or recycled construction materials (refer to Fig.4). The natural aggregates (shown in Fig. 4a) have a dense

microstructure which can be seen under the microscope (the image on the right). Recycled aggregates (RA) on the other hand are much more porous by comparison (refer to Fig. 4b).

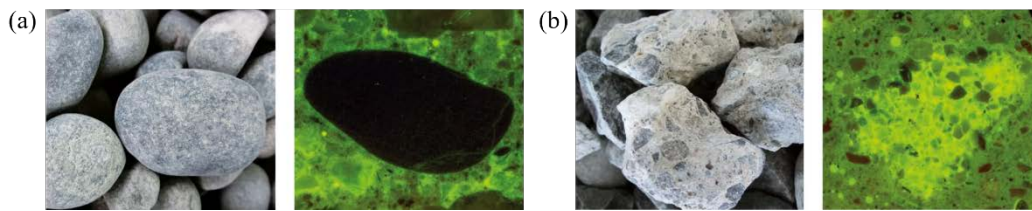

Figure 4. Aggregates used in concrete mixture: (a) natural aggregate; (b) recycled aggregate.

Source: <https://www.holcimpartner.ch/fr/betonpraxis/beton-de-recyclage>

Both concrete and clay-based materials (various types of bricks and building blocks for example) can be crushed, turned into aggregates and revalorized as recycled concrete, thus saving natural resources. In order for concrete to be recognized as recycled (RAC), it needs to contain at least 20% or 25% of recycled aggregates depending on the standard considered (EC2 or SIA2030 [16] respectively). Going further, the reference to RAC in the paper implies only mixtures containing 25% of concrete based RA.

As stated previously, such aggregates are more absorbing due to their increased porosity. Therefore, it is to be expected that RAC needs more water compared to conventional concrete. Simply adding more water into the mixture might reduce the final compressive strength. To prevent this from happening suppliers often increase the amount of cement, therefore directly enhancing the carbon footprint.

Tab.3 summarizes the amount of cement used in different types of concrete (NPKA, NPKB and NPKC) made entirely with natural aggregates (conventional concrete) or containing 25% of recycled concrete aggregates (recycled concrete).

Tab.3: Quantity of cement in various concrete types [kg/m³]

Type	Conventional concrete		Recycled concrete	
	According to SN EN 206	According to NFIC* experience	According to SN EN 206	According to NFIC* experience
NPK A	280	315	280	328
NPK B	280	315	280	328
NPK C	300	330	300	340

* NFIC - Nicolas Fehlmann Ingénieurs Conseils SA

The table shows a difference between the minimum quantity of cement recommended by the SN EN 206 standards and the average quantities that Nicolas Fehlmann engineering office (NFIC) finds on the Swiss market. Furthermore, suppliers systematically use more cement in recycled concrete mixtures compared to conventional ones.

Fig. 5 shows the amount of embodied CO₂ in 1m³ of multiple types of concrete (NPKA, NPKB and NPKC) made with cements indicated in Tab.1 and quantities from Tab.3. In other words, Fig. 5a shows the minimum theoretical carbon footprint while Fig. 5b and Fig 5c present realistic carbon emission of conventional and recycled concrete on the Swiss market. The amount of CO₂ was estimated using the Data from the lifecycle assessments in construction developed in 2016 for the Swiss market [1,2,4,13].

Looking at each individual graph, there is no major difference between the amount of embodied CO₂ in NPKA and NPKB concrete, which is to be expected given the same amount of cement used in both mixtures. The slight difference comes from the emitted carbon linked to aggregate, water and energy consumption (indicated as “other” in Fig.3). NPKC however has constantly higher values of CO₂ due to the additional amount of cement compared to the other two types. The main difference nonetheless does not come from the amount of cement but from its type, and a direct impact of reduced amount of PC clinker in the mixtures can be seen. In the most extreme case (NPKC with CEM I vs NPKA with CEM ZN/D) this can add up to 76 kg/m³ of CO₂ saved in conventional concrete, and 77 kg/m³ of CO₂ saved in recycled concrete.

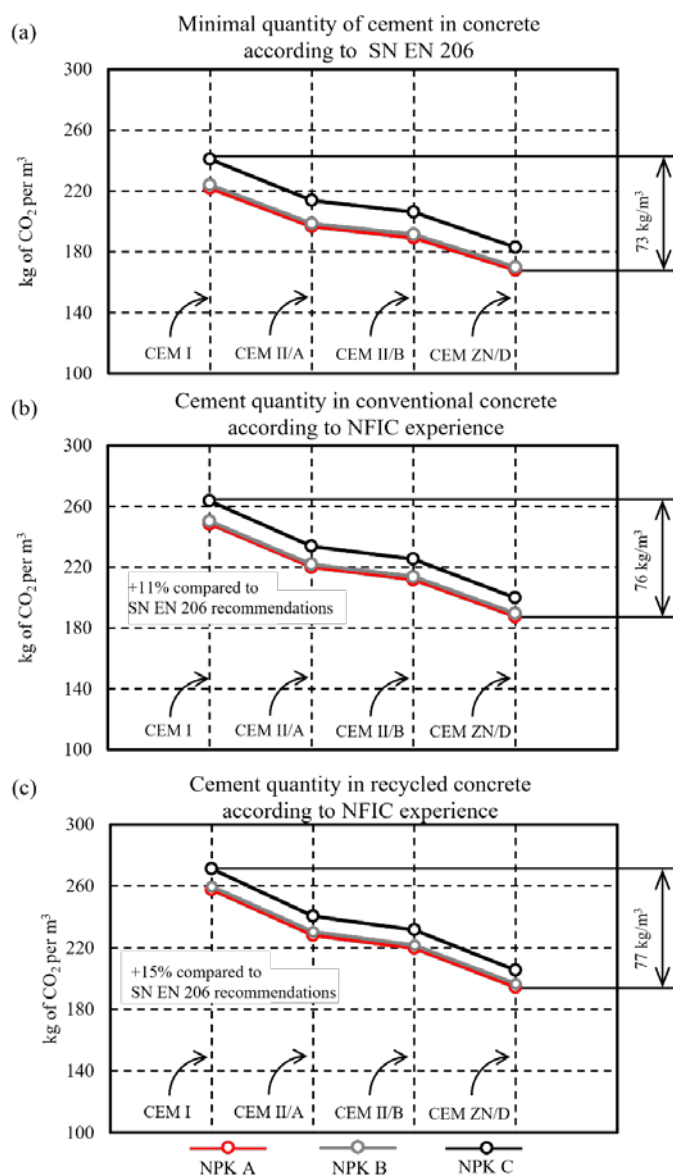

Figure 5. Amount of embodied CO₂ in 1m³ of multiple types of concrete using CEM I, CEM II A & B and CEM ZN/D: (a) assuming the minimum theoretical amount of cement; (b) assuming a realistic amount of cement used in the Swiss market for conventional concrete; (c) assuming a realistic amount of cement used in the Swiss market for recycled concrete

Keeping in mind that the data is taken from Swiss market, it is important to underline that on average additional 11% of CO₂ are emitted in reality compared to what it could be emitted respecting the SN EN 206 standard. This comes from the fact that the concrete suppliers often add more cement in order to achieve higher concrete compressive strength than the ones requested by the designers. This leaves some room for the recipe optimization that most actors are reluctant to, due to increased risks of having unacceptably weak concrete. Same thing applies to the recycled concrete where this difference reaches 15% of CO₂ emitted due to increased porosity of RA.

5. PUTTING THINGS INTO PERSPECTIVE

In order to have a clear idea on how big of an impact the rigorous choice of concrete and cement actually have on the carbon footprint, it is best to express it through some real-life examples. For this purpose, two very different projects, both developed by Nicolas Fehlmann Ingénieurs Conseils SA (NFIC), are considered.

Project Sauges 30 (see Fig.6) is a residential medium sized building located in Lausanne (CH). The load carrying structure is made from RC walls which are supported by a series of columns located in the underground parking. All slabs are made from RC, and all the façade walls are precast sandwich RC panels. The residential building has one ground floor with 5 stories and an attic, with a total area of 5'120 m² of living space. Underground parking has 1'060m² of surface and consists of a single floor. The overall theoretical volume of concrete used in Project Sauges 30 is 2'525 m³. A portion of that concrete is used for the interior elements of type NPKB. The remaining part is the NPKC type and it's being used for the construction of exterior elements exposed to the atmospheric influence and/or direct contact with soil. In other words, Project Sauges 30 is a typical medium housing project which most structural engineers and architect have constructed multiple times in their professional careers.



* DOLCI architectes, Atelier d'architecture et d'urbanisme Sàrl
** Theoretical values

Project SAUGES 30, Lausanne, Switzerland	
Parking area	1'060 m ² **
Residential area	5'120 m ² **
Number of stories	-01 + GF + 6
Volume of concrete	2'525 m ³ **

Figure 6. Residential building in Lausanne (CH) developed by DOLCI architecture and NFIC civil engineering office

Substituting the CEM I with CEM ZN/D type of cement for the entire volume of concrete used for the Sauges 30 project saves approximately 140 t of CO₂. If we compare this to the pollution of an average new passenger car produced in 2018 (see Fig.7a), this represents an equivalent of the CO₂ released from circling the globe along the equator 29 times (see Fig.7b).

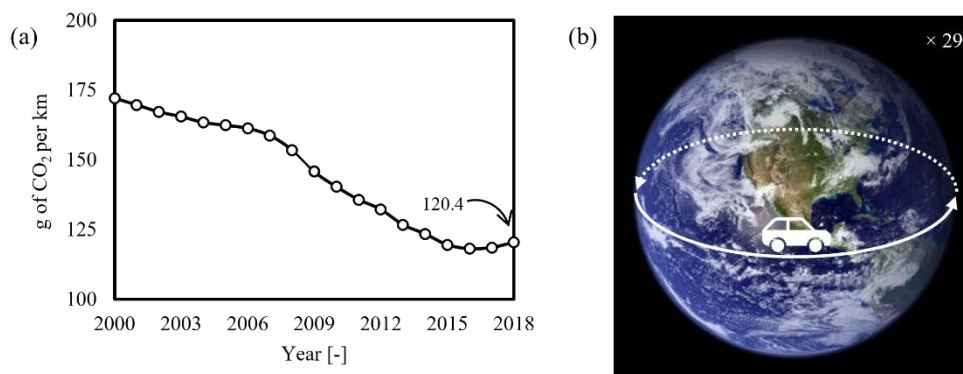

Figure 7. Amount of embodied CO₂ saving potential through a responsible cement selection on a mid-sized housing project:(a) Average CO₂ emission from new passenger cars; (b) CO₂ savings of a responsible cement selection in the SAUGES 30 Project

Another project, which is currently being developed by the NFIC office, is presented in Fig.8. It is a residential and commercial complex which is currently under construction in Lausanne. The entire superstructure is made from concrete and it consists of RC slabs that are supported with pillars and escalator/staircase cores. The complex consists of 5 buildings which are placed on 2 separate underground parking lots.



* Pont12 architectes sa
** Theoretical values

Central Malley, Lausanne, Switzerland	
Parking area	18'685 m ² **
Residential area	59'656 m ² **
Number of stories	-03 + GF + 26
Volume of concrete	32'646m ³ **

Figure 8. Commercial/Residential building complex in Lausanne (CH) developed by Implenia general contractor, Pont 12 architecture and NFIC civil engineering office

The total theoretical amount of residential surface is 59'656 m² with a total of 18'685m² of parking area. The highest building has 26 floors and with the height of 79.7 m, it will be one of the highest in the city of Lausanne. Total estimated amount of concrete used for this complex is 32'646m³. Once again by substituting the CEM I with CEM ZN/D type of cement in the concrete mixtures, approximately 2.3 million tons of CO₂ can be saved.



* Total CO₂ traffic emission in 2021

Amsterdam, Nederland	
Population	1'158'000
City area	219.3 km ²
CO ₂ traffic emission*	840'000 t
Cement choice benefit	~ 1 day of traffic induced CO ₂ saved

Figure 9. Amount of embodied CO₂ saving potential through a responsible cement selection on a Central Malley project in Lausanne (CH) comparing with traffic in Amsterdam

Comparing that saving to the total amount of CO₂ emitted by traffic in the city of Amsterdam (refer to Fig.9), one can realize that the saved amount of carbon represents an equivalent of 1 day worth of traffic.

This only demonstrates that even though the reduction of CO₂ through a critical selection of concrete and cement is significant, it is by far not the only consideration that will lead us to Net Zero carbon by 2050. However, when taking into consideration the amount of effort required by the engineers and architects to obtain these savings, this reflection is a paramount one.

6. CONCLUSIONS

Based on the facts presented in this paper, following conclusion can be drawn:

- Choosing the concrete type based on the exposure of the element has a direct impact on the carbon footprint reduction
- The difference in the carbon footprint between the concrete with the lower exposition class (XC1/XC2) and medium exposition class (XC3) is minor
- Choosing the cement type with the lowest content of PC clinker leads to a significant reduction of the carbon footprint, while being very time efficient from the engineering point of view
- Concrete suppliers often increase the amount of cement in their recipes in order to minimize the risks of delivering material with insufficient resistance to construction sites
- Using recycled concrete saves natural resources and revalorizes materials obtained from demolishing existing structures

- Concrete with recycled aggregates currently has an increased amount of cement compared to conventional concrete due to higher water absorption
- Usage of simple load-carrying mechanisms (superposed beams and pillars with little to no eccentricity) has the biggest potential to minimize the ecological impact on the environment and therefore they should be favored
- The correct choice of material represents only one step towards achieving the Net Zero carbon policy.

ACKNOWLEDGEMENT

The author of the article would like to thank Nicolas Fehlmann Ingénieurs SA for their willingness to share the internal project data used in this publication. Furthermore, the author would like to thank representatives of Orllati Granulats & Béton Group as well as the representatives of Holcim Group for the constructive discussions which helped improve this paper. Finally, the author would like to thank prof Tatjana Kočetov Mišulić and prof Vlastimir Radonjanin for their support and constructive feedback.

LITERATURE

- [1] Betonrechner Hintergrundbericht – Version 2.0, Fachstelle nachhaltiges Bauen, Fachstelle Ingenieurwesen, Zurich (CH), 2016
- [2] Cahier technique CVT 02 pour les constructions en béton de parement, 3eme édition, BETONSUISSE Marketing AG, entièrement révisée 2020
- [3] Cement and concrete as an engineering material: An historic appraisal and case study analysis, Gagg, Colin R., Engineering Failure Analysis, May 2014
- [4] Données des écobilans dans la construction 2009/1:2016, Office fédéral des constructions et de la logistique Berne (CH), édition 2016
- [5] GHG emissions of all world countries - 2021 Report, Crippa, M., Guizzardi, D., Solazzo, E., Muntean, M., Schaaf, E., Monforti-Ferrario, F., Banja, M., Olivier, J.G.J., Grassi, G., Rossi, S., Vignati, E. ,EUR 30831 EN, Publications Office of the European Union, Luxembourg, 2021
- [6] Global status report for buildings and construction - Towards a zero-emissions, efficient and resilient buildings and construction sector, Global alliance for buildings and structures, IEA, UN environment program, 2019
- [7] How can we reduce the embodied carbon of structural concrete, Paul Astle, The institution of structural engineers, London (UK) February 2021
- [8] How to calculate embodied carbon, O.P. Gibbons and J.J. Orr, The institution of structural engineers, London (UK) August 2020
- [9] Le béton selon la norme SN EN 206: 2013 + A1: 2016, Holcim (Suisse) SA, édition main 2020
- [10] Le ciment selon la norme SN EN 197-1:2011 et le cahier technique SIA 2049:2014, Holcim (Suisse) SA, édition main 2020
- [11] LETI Climate Emergency Design Guide, How new buildings can meet UK climate change target, London energy transformation initiative (UK),2020 edition
- [12] Liste des produits et CGV Granulats + Bétons Centrales de Sierre, Sion, Martigny, avril 2020
- [13] Ökobilanz ausgewählter Betonsorten Schlussbericht – Version 4, Fachstelle nachhaltiges Bauen, Fachstelle Ingenieurwesen, Zurich (CH), 2016
- [14] On sustainable structural design, N. Kostic, Proceedings of the International fib Symposium on Conceptual Design of Structures Sept. 16-18, 2021, Attisholz, Switzerland
- [15] Proceedings of the International fib Symposium on the Conceptual Design of Structures held in Attisholz Areal, Switzerland, September 16-18, 2021
- [16] SIA 2030:2021 Construction, Béton avec granulats recyclés, SIA Zurich (CH), 2021

02

Review paper I Прегледни научни рад

DOI 10.7251/STP2215011L

ISSN 2566-4484



Daniel Lordick, TU Dresden, daniel.lordick@tu-dresden.de

CONSTRUCTION OF SKEW RULED SURFACES BY MANIPULATING CONTROL LINES

Abstract

When it comes to doubly curved surfaces in construction, especially shell structures, the skew ruled surfaces play a prominent role, because they are statically efficient and relatively easy to produce [1]. However, in order to fully exploit the design potential of this class of surfaces, conventional CAD programs do not provide adequate tools. From the priority program 1542 by the German Research Foundation (DFG) named *Concrete light*, an add-on is presented [2] that facilitates parametric design with ruled surfaces on the basis of line geometry and also enables a connection to finite element methods.

Keywords: Line Geometry, ruled surface, interpolation algorithms, parametric design

КОНСТРУКЦИЈА ЗАКРИВЉЕНИХ ПРАВОИЗВОДНИХ ПОВРШИ МАНИПУЛАЦИЈОМ КОНТРОЛНИХ ЛИНИЈА

Сажетак

Када је ријеч о двоструко закривљеним површима у грађевинарству, посебно о конструкцијама љуске, завојне правоизводне површи имају значајну улогу, јер су статички ефикасне и релативно лаке за израду [1]. Међутим, да би се у потпуности искористило потенцијал пројектовања ове групе површи, уобичајени програми CAD не пружају одговарајуће алате. Из приоритетног програма 1542 Њемачке истраживачке фондације (ДФГ) под називом *Concrete light*, представљен је додатак [2] који олакшава параметарско пројектовање са правоизводним површима на основу линијске геометрије и такође омогућава повезивање са методама коначних елемената.

Кључне ријечи: линијска геометрија, правоизводна површи, интерполациони алгоритми, параметарско пројектовање.

1. RULED SURFACES

1.1. RULED SURFACES AS A SUBSET OF NURBS SURFACES

In common CAD programs, ruled surfaces occur as a subgroup of *Non-Uniform Rational Basic Splines* (NURBS). A NURBS surface is a ruled surface if the parameter curves (*isocurves*) in at least one direction have the algebraic order 1 (degree 1, linear), i.e. if they are straight line segments and thus the *generators* (rulings) of the ruled surface. This can be achieved in two ways: Either one generates the NURBS surface by connecting exactly only two profile curves with a loft, or by placing the loft surface through a set of exclusively straight lines.

But, ruled surfaces are by no means unambiguously and traceably defined by this procedure. In the first case, the generators always connect corresponding parameter points on the profile curves. However, the distribution of the parameter points depends on the parameterization of the profile curves and is therefore largely arbitrary. This degree of freedom reflects the fact that ruled surfaces are only uniquely determined by three curves. Two curves allow for an infinite number of ruled surfaces and the CAD user initially has no control, which surface the NURBS algorithm offers. To obtain a desired ruled surface, additional processing is essential. For example, it may be required that all generators be parallel to a directional plane, which leads to a conoidal surface. It is then necessary for the user to draw a set of such generators and to loft the surface through these straight lines as described above.

If, on the other hand, a set of straight lines is given, the shape of the ruled surface depends strongly on the number of given lines. The NURBS algorithm interpolates the distances as if control points for the second set of parameter curves were given. The result is in general not predictable. In order to approximate the boundary curves of the surface to the first profile curves again, the generators must be placed sufficiently close to each other.

1.2. RULED SURFACES FROM A LINE GEOMETRY PERSPECTIVE

We are used to understand and handle our three-dimensional space by defining points with three coordinates in the Cartesian coordinate system. However, if we consider the straight lines as basic elements instead of the points, we find out that at least four coordinates are needed to define a straight line: if you first define a starting point in the x-y-plane, this binds two coordinates. A further coordinate gives - for example with an angle - the direction in the x-y-plane and a fourth one the gradient. The manifold of all straight lines in the three-dimensional space is therefore four-dimensional. This makes the handling of straight lines considerably challenging.

From a mathematical point of view, one approach is to embed the four coordinates again as points in a model space of higher dimension. In the present case, the so-called Study sphere is used for this purpose, which, among other things, is also suitable for describing the motions of six-axis robots [3]. Now, each point on the four-dimensional Study sphere corresponds to an oriented straight line in three-dimensional space. The Study sphere can be thought of as a unit sphere where each point on the surface signifies a straight line direction. Attached to the point of the sphere is another vector tangential to the sphere, which encodes the distance of the straight line to the origin of the coordinates. This point model can now be used for elegant calculations based on dual numbers. A detailed description can be found in [4].

The calculations on the Study sphere were adapted for civil engineering under the aspect of lightweight constructions in the research project "Force-adaptive discretization of lightweight concrete elements by means of line geometric modeling" at the TU Dresden and applied in the follow-up project together with Mike Schlaich at the TU Dresden under the title "Lightweight Concrete Structures Based on Line Geometry". In particular, the task was solved, how, after the interpolation algorithms on the Study sphere, the actually infinitely long straight lines can be reasonably restricted to the relevant area in three-dimensional space. One realization is:

2. THE ADD-ON LINEGEOMETRY

LineGeometry is an add-on for *Grasshopper*, which in turn serves as a plug-in for the CAD software *Rhinoceros 3D*. In recent years, *Grasshopper* has become an extremely popular tool for parametric modeling of three-dimensional objects. *LineGeometry* fits seamlessly into this working environment.

2.1. INSTALLATION

The add-on is available for free download with additional material here: [5]. In the package you will find the add-on file with the extension *.gha, which can be dragged and dropped onto the workspace of Grasshopper (canvas). Then the functions can be called via the LineGeometry tab. The website also provides sample files and additional information.

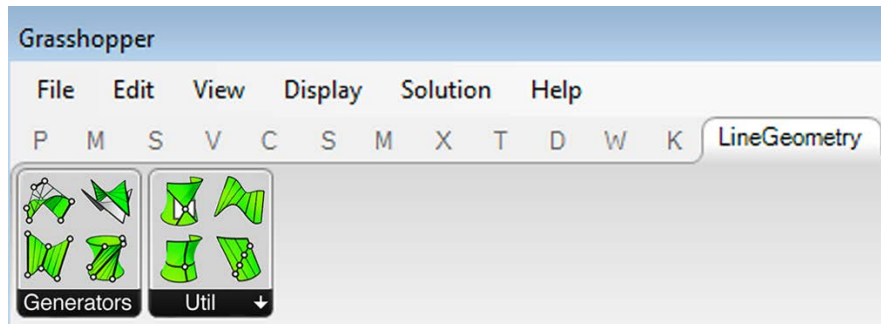

Figure 1. The LineGeometry add-on in Grasshopper.

The functions of *LineGeometry* are distributed over two blocks. The first block (*Generators*) contains the tools for creating ruled surfaces as a set of generators. The second block (*Util*) contains auxiliary functions.

2.2. GENERATION OF RULED SURFACES (GENERATORS)

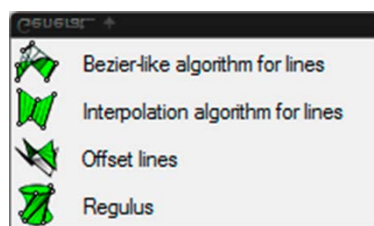

Figure 2. Generators in the LineGeometry add-on.

The starting point for the generation of ruled surfaces with *LineGeometry* is always a selection of oriented control lines. The orientation of the straight lines is given by the parameterization during drawing, where the end point drawn first is also the start of the parameterization. In case of problems, the orientation of individual lines can be corrected at any time with the tools of Rhinoceros or Grasshopper (e.g. with the Grasshopper component *Flip Curve*). For the following illustrations, four mutually skewed lines have been drawn in Rhinoceros and are available in Grasshopper via the *Curve component* (not *Line!*) under the name *Crv - four oriented lines*. The control lines are labeled with the numbers 0 to 3. In the illustrations of the Grasshopper canvas, the components from the *LineGeometry* add-on are each highlighted by a green background.

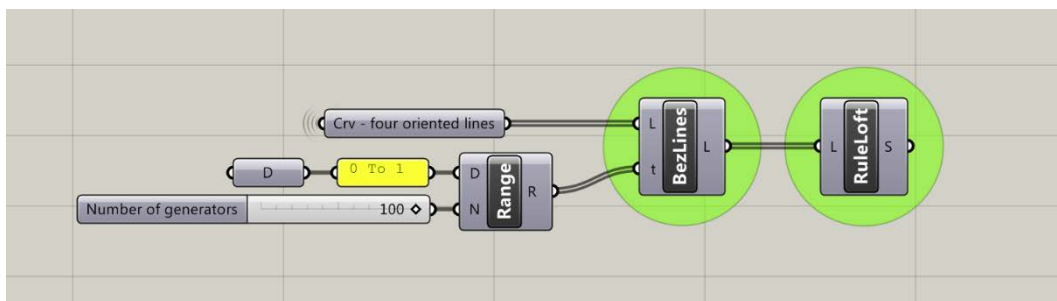

Figure 3. BezLines in the LineGeometry add-on.

The first component is called **Bezier-like algorithm for lines** (*BezLines*) (Fig. 3). It transfers the Bezier algorithm for splines to the Study sphere and calculates a set of generators from the given control lines. The generators belong to a ruled surface interpolating the control lines. In general, only the first and the last control line are contained in the ruled surface. The remaining straight lines are *control lines* in the same way that for splines the vertices of the control polygon control the spline. The input *L* (*Control lines*) accepts the control lines as a list and the input *t* (*Range of*

parameters) accepts any number of values between 0 and 1 (Domain D: 0 To 1, also in the following, if not stated otherwise). Each value t corresponds to one generator. The values 0 and 1 coincide with the first and the last control line. At the output L (Resulting generators of the ruled surface) are the generators of the ruled surface (Fig. 4).

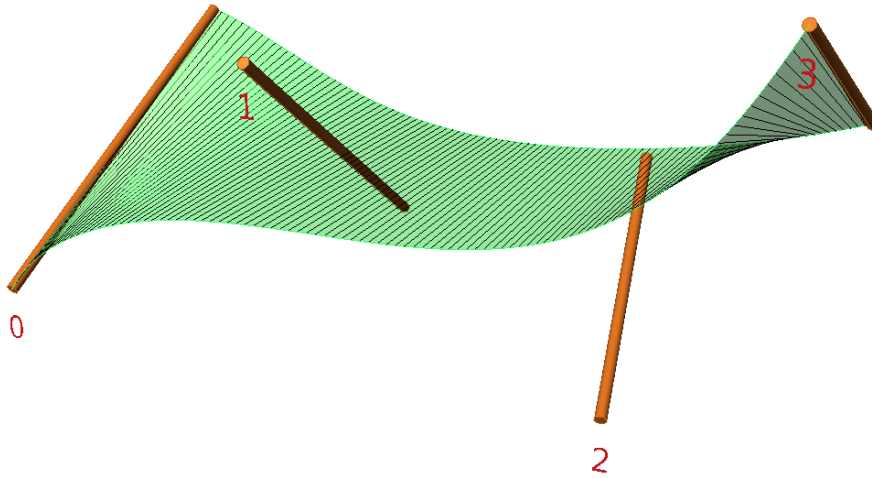

Figure 4. Ruled surface from four control lines with BezLines.

If the value domain 0 to 1 is exceeded, the surface is extrapolated with more or less reasonable results. If only two control lines are passed at input L, the result of the interpolation is a helicoid (Fig. 5). The helicoid is the only ruled surface which at the same time is a minimal surface (apart from the trivial case of the plane). In this case, the contrast to the loft functions of Grasshopper and Rhinoceros becomes obvious, because there a loft between two skew lines always results in a hyperbolic paraboloid.

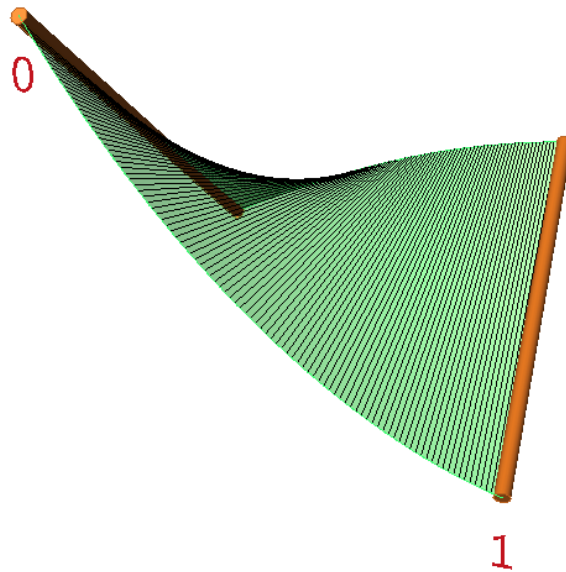

Figure 5. Helicoid as interpolation of two control lines, that is, two points on the Study sphere.

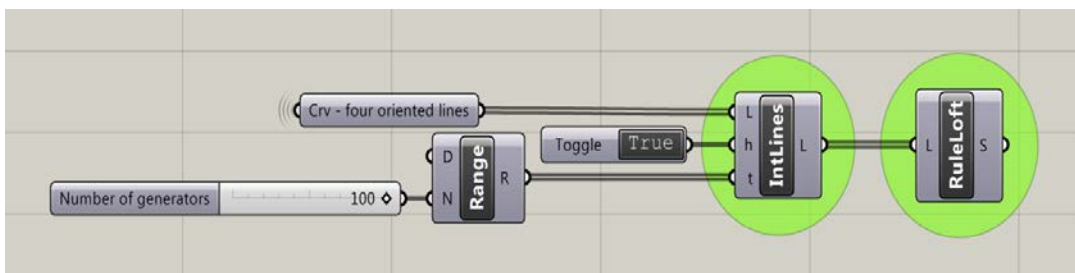

Figure 6. IntLines in the LineGeometry add-on.

The second component is called **Interpolation algorithm for lines** (*IntLines*) (Fig. 6). For this component, the Aitkin algorithm for drawing splines was transferred onto the Study sphere. The difference to *BezLines* is that now the control lines are actually contained in the interpolating ruled surface (Fig. 7).

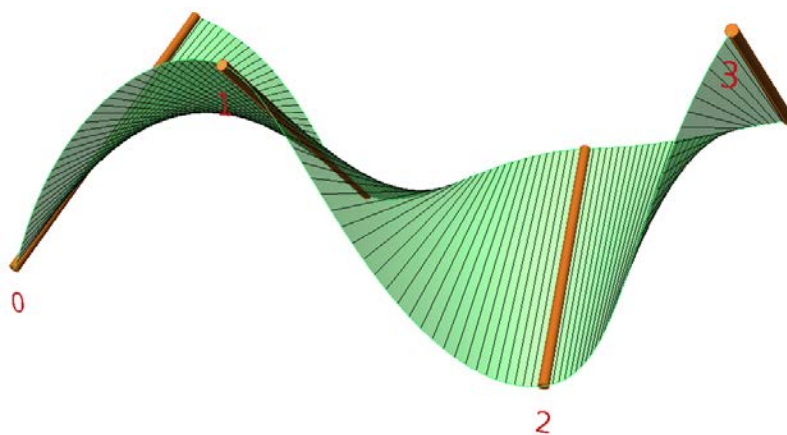

Figure 7. Ruled surface from four control lines with *IntLines*.

The additional input *h* (*Enable piecewise linear interpolation*) offers the possibility to connect the control lines piecewise with helicoids (Fig. 8). *Linear interpolation* thus means that geodesic ("shortest") paths are chosen between those points on the Study sphere, which correspond to the control lines. The *BezLines* component could be used to accomplish the same thing by feeding the control lines in pairs. Here, piecewise interpolation is easily achieved if *h* is 1 or *True*. With 0 or *False* *IntLines* provides the smooth interpolation with the algorithm derived from Aitken.

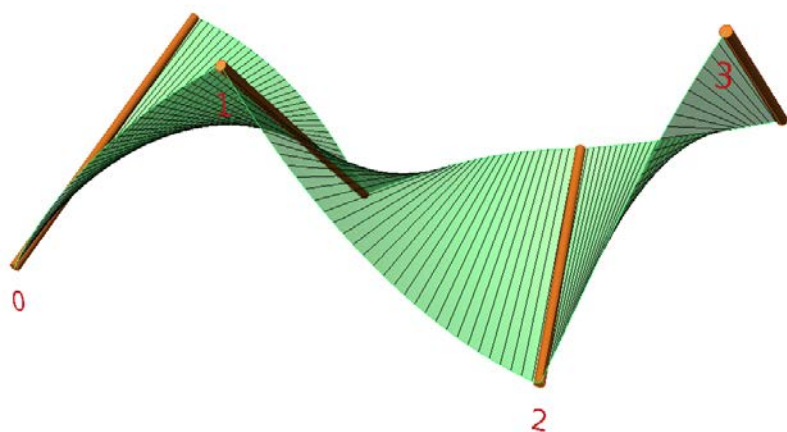

Figure 8. Piecewise linear interpolation with *IntLines*.

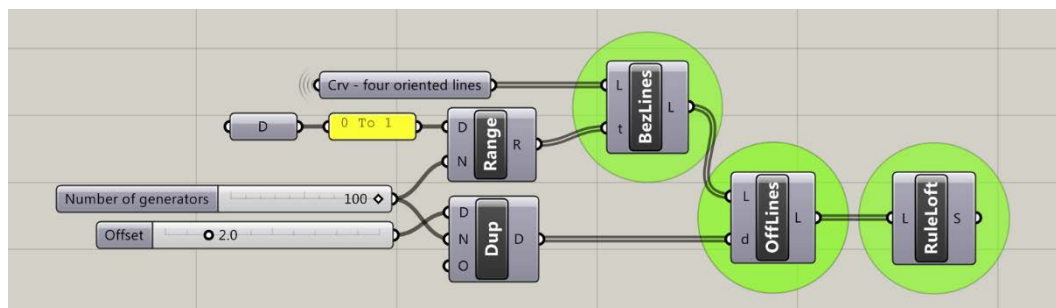

Figure 9. *OffLines* in the *LineGeometry* add-on.

The third component is called **Offset lines** (*OffLines*) (Fig. 9). As is well known, the parallel surface of a skew ruled surface is not a ruled surface any more. However, especially in civil engineering it is often required, to define both sides of a structural element as ruled surfaces. *OffLines* provides an alternative to the standard surface offset by generating a "parallel" ruled surface from a ruled surface (Fig. 10). The component requires as input in *L* (*Lines*) a discrete set of generators of a ruled surface

and for each generator the desired distance in d (*Distance value for each line*). It is therefore necessary, if the distance is to be the same everywhere, to duplicate the desired value with the Grasshopper component *Duplicate Data (Dup)* a corresponding number of times. Again, the ruled surface created with *OffLines* does not have the same distance from the original surface everywhere. Depending on the curvature of the surface, the distance of the generators in the center of the surface is significantly smaller than at the edge. For the calculation of the offset lines, only the end points of the generators are offset normal to the initial surface and then connected again with a straight line. By the way, as a special feature, the component allows a different distance value to be taken into account for each generator. Thus, functions for manipulating the distances can be used here, for example depending on possibly existing load cases.

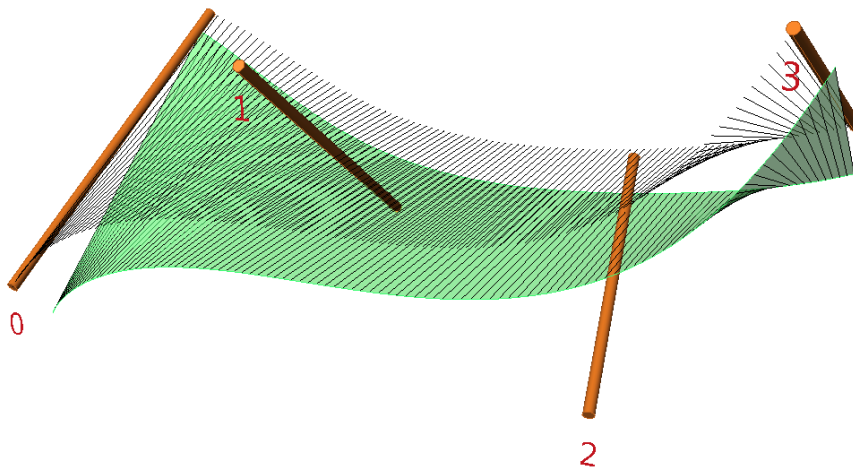

Figure 10. "Parallel" ruled surface to Fig. 4 using *OffLines* (in green).

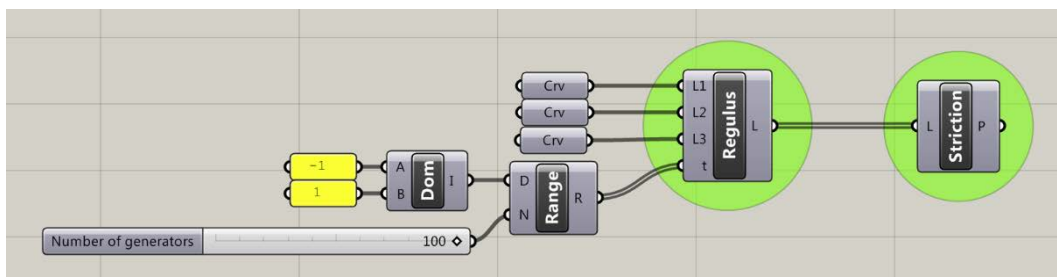

Figure 11. *Regulus* in the *LineGeometry* add-on.

The fourth component is called **Regulus** (Fig. 11). With it, the ruled surfaces of second order can be generated, whereby the term *Regulus* emphasizes that only one set of generators is created. Remember, on every ruled surface of second order there are two reguli. Explicitly, this component can generate the hyperbolic paraboloid and the one-sheet hyperboloid (Fig. 12). Three generators are required as input. These are connected individually to the inputs *L1* to *L3* (*Line 1* to *Line 3*), which determines the sequence. At input *t* (*Range of parameters*) a parameter is passed for each desired generator. Somewhat unusual is the parameter range from -1 to 1 . The first generator at *L1* corresponds with -1 , the second with 0 and the third with 1 . Here it is again possible to extend the parameter range. However, then it must be reckoned with the fact that the generators are not evenly distributed in the Euclidean sense.

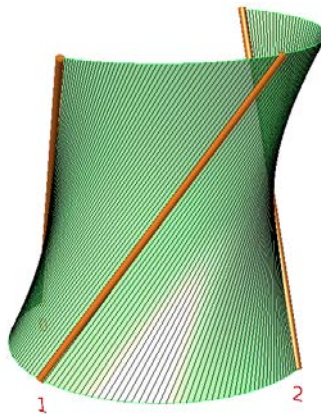

Figure 12. *Regulus through three straight lines (one-sheet hyperboloid).*

2.3. AUXILIARY TOOLS (UTIL)

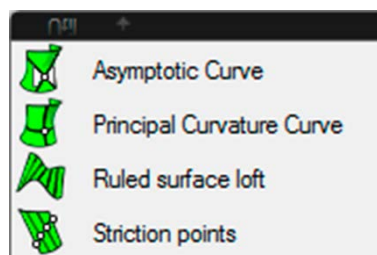

Figure 13. *The Util block in the LineGeometry add-on.*

The auxiliary tools (*Util*, Fig. 13) of *LineGeometry* are intended to support the work with ruled surfaces and the approximation of freeform surfaces with ruled surfaces.

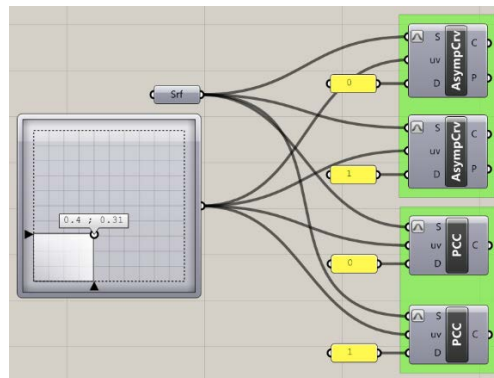

Figure 14. *AsympCrv and PCC in the LineGeometry add-on.*

On non-elliptic surfaces (Gaussian curvature not positive), the first function **Asymptotic curve** (*AsympCrv*) (Fig. 14, upper half) determines the asymptotic curves, i.e. those curves with vanishing normal curvature, passing through a point with certain u - v -coordinates, which are present at the input uv (*Point uv*) (Fig. 15). It is useful to activate the input function *Reparameterize* at the input S (*Surface*), so that u and v can be selected in the domain between 0 and 1 . Since there are generally two asymptotic curves through each point with negative Gaussian curvature, the desired one can be selected at input D (*Direction*) with 0 or 1 . The asymptotic curves of a freeform surface are a good orientation for how the surface could be approximated by straight lines, i.e. by patches of ruled surface. For example, the function could be followed by a curvature analysis to determine the "better" (less curved) of the two sets of curves.

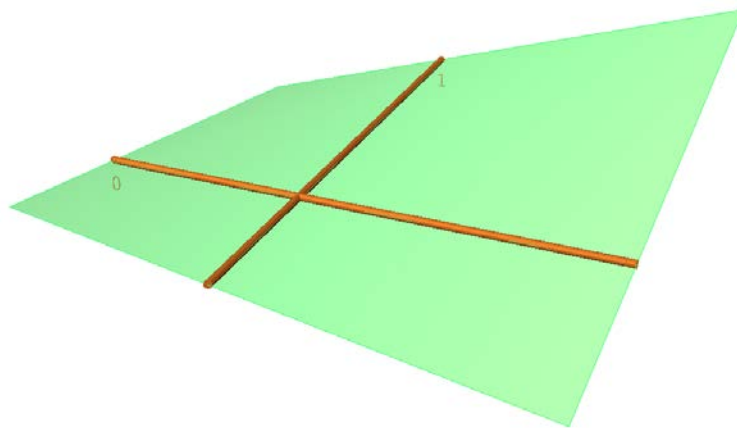

Figure 15. *AsympCrv to a point on a hyperbolic paraboloid yields two generators.*

The second function **Principal Curvature Curve (PCC)** (Fig. 14, lower half) determines the principal curvature curves through the point with the coordinates u and v (Fig. 16). This is of particular interest for the discretization of doubly curved surfaces with planar quadrilateral facets (PQ-meshes) [6].

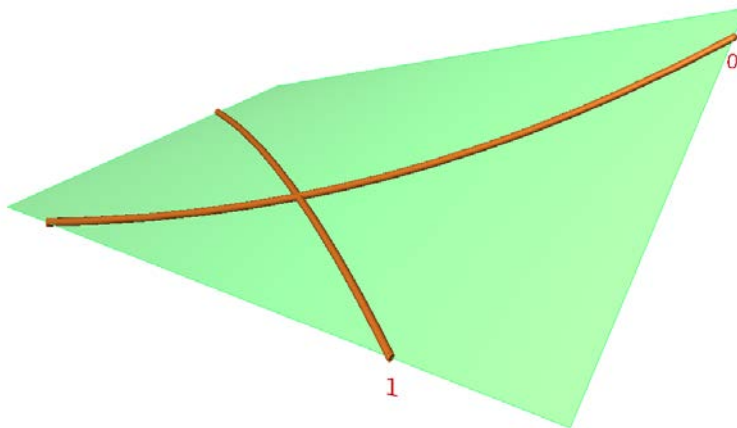

Figure 16. *PCC to a point on a HP surface yields parabolas in the principal curvature directions.*

The third function **Ruled surface loft (RuleLoft)** (Figs. 3, 9, 6, 11) is an alternative to Grasshopper's own loft function. The problem with the on-board component is that it becomes very slow when the number of curves is comparatively high, and this is exactly what is useful to approximate the ruled surfaces well. *Ruled surface loft* avoids this problem in a very simple way: the endpoints of the generators are interpolated with curves and then only these two curves are lofted. Since the endpoints determine the parameterization on the curves, the result is identical to the standard loft function - but with much better performance.

The fourth function **Striction points (Striction)** calculates the central point on each generator, i.e. the point that is closest to the (infinitesimal) next generator. Striction points are only meaningful on skew surfaces. There they fulfill a significant curve, the striction curve, along which the ruled surface has its strongest curvature. The curve is also relevant from a structural point of view, since the highest stiffness can be expected there (Fig. 17). The striction points are calculated approximately and are more accurate the more generators in L (*Generators of the ruled surface*) are passed. Striction points can also lie outside of the represented surface regions.

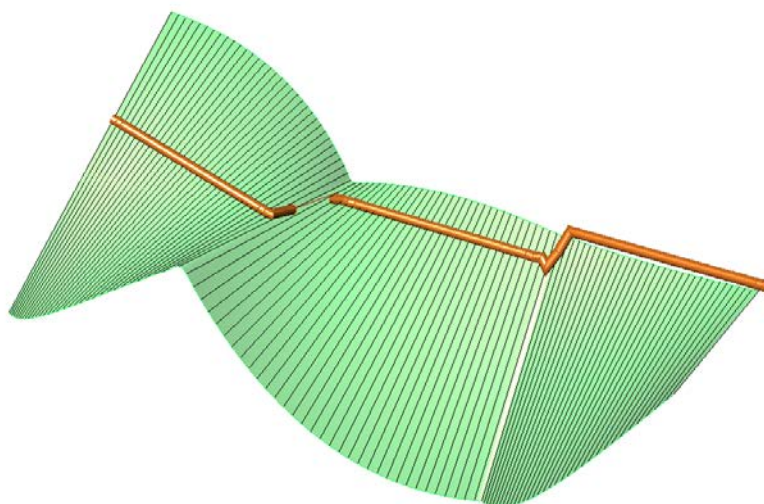

Figure 17. Striction curve of the surface of Fig. 08, which, contrary to the illustration, is not continuous. The three discrete striction lines of the three helicoidal segments coincide inevitably with their respective axes.

3. APPLICATIONS AND CONCLUDING REMARKS

The add-on *LineGeometry* was used in the development of the demonstrator "Shell Bridge with Ruled Surface Geometry" in SPP 1542, funded by the German Research Foundation (DFG) [7]. There, line geometric modeling was combined with finite element methods in an optimization process. Furthermore, the add-on was the starting point of projects during the summer school "Line Geometry for Lightweight Structures" in September 2018 at TU Dresden [8]. In these projects, the add-on was particularly convincing in that the mathematical superstructure makes the ruled surfaces appear more elegant and smoother than could be achieved with the usual methods. In this respect, it pays off that the interpolation algorithms are in a natural way based on the helicoid, i.e. a minimal surface.

ACKNOWLEDGEMENTS

The add-on *LineGeometry* was developed under the supervision of the author by the research group *Geometric Modeling and Visualization* (GMV) at the Institute of Geometry, TU Dresden, in the course of the priority program "Concrete Light" (SPP 1542), funded by the German Research Foundation (DFG). Significant contributions were made by Markus Hagemann, Daniel Klawitter and Michael Pott. Martin Eichenauer (also GMV) produced the formwork elements for the shell bridge demonstrator in the *Makerspace* of the SLUB Dresden. The project partners of the TU Berlin from the *Chair of Conceptual and Structural Design* lead by Mike Schlaich were responsible for the production of the shell bridge and the software interface to SOFiSTiK. The interface, named GHtoSOFi, was programmed by Konrad Freymann and Juan Pablo Osman Letelier (prize winners in the competition *Auf IT gebaut* 2018). My sincere thanks go to all those involved and to the DFG.

LITERATURE

- [1] D. Lordick, D. Klawitter, M. Hagemann, "Liniengeometrie für den Leichtbau," in *Leicht Bauen mit Beton. Forschung im Schwerpunktprogramm 1542, Förderphase 1*. S. Scheerer, [2] M. Curbach, Ed. Dresden: Institut für Massivbau, Technische Universität Dresden, 2014, pp. 224-235.
- [3] H. Pottmann, J. Wallner, *Computational Line Geometry*. Heidelberg, Berlin etc.: Springer, 2001.
- [4] M. Hagemann, D. Klawitter, D. Lordick, "Force Driven Ruled Surfaces," in *Journal for Geometry and Graphics (JGG)*, vol. 17, No. 2, pp. 193-204, 2013.
- [5] Daniel Lordick. "Add-on for Grasshopper in Rhinoceros 3D – LineGeometry". Internet: <http://linegeometry.daniellordick.de>, [May 2, 2022].
- [6] D. Lordick, "Intuitive Design and Meshing of Non-Developable Ruled Surfaces," in *Proceedings of the Design Modelling Symposium Berlin*, 2009, pp. 248-261.

- [7] J. P. Osman Letelier, A. Goldack, M. Schlaich, D. Lordick, J. Grave: "Shape optimization of concrete shells with ruled surface geometry using line geometry," in Proceedings of the IASS Annual Symposium 2017 »Interfaces: architecture.engineering.science«, 2017, Hamburg, Germany, 2017, Paper #9199 1-10 (published on a USB flash drive).
- [8] C. Röss, D. Lordick. "[Documentation of the] Summer School LGLS at the TU Dresden – long version". Internet: <https://www.youtube.com/watch?v=6ZdpHvWthRI>, [May 2, 2022].

03

Research paper | Originalni naučni rad
DOI 10.7251/STP2215021A
ISSN 2566-4484



Uğur Avdan, Eskisehir Technical University, uavdan@eskisehir.edu.tr
Gordana Kaplan, Eskisehir Technical University, kaplangorde@gmail.com
Dilek Matci, Eskisehir Technical University, dkmatci@anadolu.edu.tr
Firat Erden, Eskisehir Technical University, firaterdem5@gmail.com
Zehra Yigit Avdan, Eskisehir Technical University, zyigit@eskisehir.edu.tr
Ece Mizik, Eskisehir Technical University, ecemizik@gmail.com
Ilknur Ozudogru, Eskisehir Technical University, ilknurozudogru@eskisehir.edu.tr

EVALUATING MACHINE LEARNING MODELS FOR SOIL SALINITY ESTIMATION USING SATELLITE IMAGERY

Abstract

Salinity is one of the most critical problems for agricultural lands. Soil salinity should be monitored with fast, economical and accurate data and methods. In this study, soil salinity was estimated using remote sensing data and machine learning algorithms, where five different methods were used, and the results were compared. As a study area, Alpu, Turkey has been selected. Within the scope of the study, on-site measurements were made in cultivation areas where there are different agricultural products such as beets, wheat, tomatoes, and corn in the district. The results show that machine learning algorithms and PlanetScope images successfully determine soil salinity. Future studies will evaluate the methods by taking samples from different product classes and wet/arid lands.

Keywords: Remote Sensing, Soil salinity, Machine learning, PlanetScope.

ОЦЈЕНА МОДЕЛА МАШИНСКОГ УЧЕЊА ЗА ПРОЦЈЕНУ САЛИНИТЕТА ТЛА КОРИШТЕЊЕМ САТЕЛИТСКИХ СНИМАКА

Сажетак

Салинитет је један од најважнијих проблема за пољопривредна земљишта. Салинитет земљишта треба пратити брзим, економичним и тачним подацима и методама. У овом истраживању, салинитет земљишта је процијењен кориштењем података даљинске детекције и алгоритама машинског учења, гдје је кориштено пет различитих метода, а резултати су упоређени. За подручје истраживања одабран је град Алпу у Турској. У оквиру истраживања извршена су мјерења на лицу мјеста у подручјима узгоја различитих пољопривредних производа као што су репа, пшеница, парадајз и кукуруз. Резултати показују да алгоритми машинског учења и снимке сателитске констелације PlanetScope успјешно одређују салинитет земљишта. Будућа истраживања ће оцијенити ове методе узимањем узорака из различитих група производа и влажних/сушних земљишта.

Кључне ријечи: даљинска детекција, салинитет земљишта, машинско учење, PlanetScope

1. INTRODUCTION

Soil salinity is considered one of the most critical environmental problems, especially in arid and semiarid regions, as it causes land degradation and desertification [1,2]. This dynamic phenomenon can occur due to natural processes or human activities and can significantly threaten soil productivity and agricultural land [3]. Additionally, minimizing the risk of soil salinity decreases environmental issues and agricultural economic losses [4]. Due to the harmful effects of soil salinity on soil fertility and agricultural production, various practices are required to protect soil quality. The first step of these applications is to monitor the severity of soil salinity [5].

Salinity parameters, critical for ensuring soil sustainability, are often determined through on-site measurement and laboratory analysis. Electrical conductivity (EC) is used to determine soil salinity. It is measured using a saturated paste of soil samples, extracted in various water ratios, and on-site measuring methods. Collecting soil samples and conducting laboratory examinations is expensive and time-consuming [6]. Furthermore, using these approaches to detect salinity in large areas, dynamically monitor the temporal and spatial change of the salting process, and determine the salted zones is difficult [7]. Fast and cost-effective remote sensing technologies for determining and evaluating salinity-affected areas' geographical and temporal distribution have been developed in recent years [8,9].

Various salinity indices have been developed in recent years to detect salt-affected areas using satellite images, most of which are based on the spectral characteristics of soil salinity in various bands of satellite data [4,10]. With creating a regression model between these spectral indices and EC values, soil salinity maps can be obtained from satellite images. Traditional regression analysis methods and machine learning methods are the two primary regression approaches used to estimate soil salinity. Traditional regression analysis methods consist of least squares regression and partial least squares regression (PLSR) methods [11]. Machine learning methods are algorithms that learn solutions from data for decision-making and prediction about real-world problems. The most important feature that distinguishes it from traditional methods is that machine learning algorithms use a large amount of data to train the model and learn how to achieve tasks from the data [12].

Several attempts have been made to produce soil salinity maps using machine learning. Wang, *et al.* [13] have proposed a new spectral index and have used a neural network to produce soil moisture and salinity inversion. Similarly, Habibi, *et al.* [14] have investigated the quantitative assessment of soil salinity using remote sensing data based on the artificial neural network. Wang, *et al.* [15] have evaluated three different machine learning algorithms (Support Vector Machine (SVM), Random Forest (RF), and Artificial Neural Network (ANN)) for soil salinity mapping with Sentinel-2 MSI data. In another study, Taghadosi, Hasanlou and Eftekhari [5] have used SVM to retrieve soil salinity from Sentinel-2 MSI images. Wu, *et al.* [16] have compared the SVM and RF methods for salinity mapping from a combined dataset consisting of Landsat 5 Thematic Mapper (TM) and ALOS L-band radar data. Wang, *et al.* [17] have integrated remote sensing and landscape characteristics to estimate soil salinity using machine learning methods. Wang, Chen, Wang and Li [11] have compared the performance of different machine learning algorithms for estimating the soil salinity of salt-affected soil using field spectral data.

In these studies, Landsat-8 OLI and Sentinel-2 MSI sensors have been used. However, since these sensors have medium spatial resolution and do not give frequent temporal data, the success of sensors with higher spatio-temporal resolution in determining soil salinity should be tested. Commercial satellite images, such as the PlanetScope, may be utilized to produce greater spatial resolution soil salinity maps. Daily high-resolution (3 m) Planetscope images can generate daily salinity indices because of their great geographical and temporal resolution. There has been no detailed investigation of soil salinity mapping from Planetscope images using different machine learning algorithms. This study set out to investigate the usefulness of different machine learning methods for soil salinity mapping from Planetscope images.

2. METHODS

2.1. STUDY AREA AND DATA

Eskişehir province is located northwest of the Central Anatolia Region of Turkey. This study was carried out in the Alpu district of Eskişehir Province, which has an area of 1,059.13 km² and an altitude of 700 m. When we examine the land distribution of the district, it is analyzed that 37.8% is agricultural land, 36.8% is forest land, 20.8% is meadow/pasture land and 4.6% is non-agricultural land. 37.8% of the study area is irrigated agricultural land and 62.5% is arid. The district's climate is a continental climate typical of the Central Anatolia Region, with hot and dry summers, rainy and

cold winters, rainy and warm spring months, and deep and dry autumn months. The average annual precipitation is 398.1 kg, while the temperature in the district ranges from 30 to 38 °C in summer and -5 to -2 °C in winter (https://www.bebka.org.tr/admin/datas/sayfas/198/alpu-ilce-raporu_1568787633.pdf). The district has high agricultural crop productivity with its productive soils, and agricultural activities form the economic basis of the region [18,19].

Within the scope of the study, on-site measurements were made in cultivation areas where there are different agricultural products such as beets, wheat, tomatoes, and corn in the district. On 6 and 7 October 2020, the measurement was carried out using a random sampling method at soil surface in cultivated and harvested areas. By taking three different soil samples in the same point, the effects of the irrigation process on the electrical conductivity (EC) value were evaluated. During the measurement process, the coordinates of each measurement point were recorded using a handheld GPS device. The electrical conductivity values, which provide us with information about the salinity of the study area, were measured with the PNT 3000 COMBI+ device at the surveying points.

Planetscope consists of more than 120 nano-satellites manufactured by Planet Labs, Inc. The Planetscope system provides satellite images daily, high resolution (3 m) and 4-band (red, green, blue, and near-infrared).

2.2. METHODOLOGY

Soil samples of soil salinity were taken from different agricultural area types in the study area. The study made use of a PlanetScope imagery from October 7, 2020. Planetscope is a collection of more than 120 nano-satellites built by Planet Labs, Inc. The Planetscope system produces daily satellite photos with very high resolution (3 m) in four bands (red, green, blue, and near-infrared). Several spectral indices have been developed in the literature using remote sensing data for detecting and mapping salinity. Table 1 lists the spectral indices utilized in this research. While there are many salinity indices in the literature, because of the limitation of the spectral resolution of PlanetScope, we used the ones that only include RGB and NIR bands.

Table 1. Details of the used salinity indices

Salinity Index (SI)	Formula	Reference
SI - 1	$SI = \sqrt{B \times R}$	[20]
SI - 2	$SI = \sqrt{G \times R}$	[20]
SI - 3	$SI = \sqrt{G^2 + R^2 + NIR^2}$	[21]
SI - 4	$SI = \sqrt{G^2 + R^2}$	[21]
SI - 5	$SI = \frac{B}{R}$	[22]
SI - 6	$SI = \frac{B-R}{B+R}$	[22]
SI - 7	$SI = \frac{G \times R}{B}$	[22]
SI - 8	$SI = \frac{B \times R}{G}$	[23]
SI - 9	$SI = \frac{NIR \times R}{G}$	[23]

Machine learning has been widely used in remote sensing application [24]. Decision tree algorithm have been resulted successfully in different studies. Decision tree learning is an approach often used in data mining. The objective is to develop a model that predicts the value of a target variable based on a number of input factors. Thus, this study aims at evaluating several decision tree algorithms for soil salinity prediction. Five tree algorithms have been evaluated in this study, namely, Decision Stump (DS), RF, M5P, Alternating Model Tree (AMT), Rapid Decision Tree (REPTree). Here we give a brief explanation of the used techniques.

DS are one-level decision trees primarily intended to be poor learners for boosting techniques. They are commonly called "one-rule" classifiers since they only predict class membership using a single characteristic. However, because the underlying metric for "best split" differs, executing these two methods will almost certainly result in somewhat different classifiers. The RF comprises many individual decision trees that work together as an ensemble. Each individual tree in the random forest produces a class prediction, and the class with the most votes becomes the prediction of our model. The M5P model tree reconstructs the M5 method [25], which is based on the standard decision tree but includes a linear regression function at the leaves nodes. The decision tree represents the algorithms in the form of a tree that has been educated using data to produce nodes [26]. In a single

tree structure, alternating decision trees give the predictive capability of decision tree ensembles. They are a type of option tree, which are decision trees that have been enhanced with option nodes and produced via boosting [27]. RepTree is a rapid decision tree learner that constructs a decision/regression tree using information gain as the splitting criteria and prunes it with the reduced error pruning technique [28].

The five algorithms have been applied to our dataset. In order to investigate the classification algorithms, five statistical parameters have been evaluated, Correlation Coefficient (CC) indicating the specific measure that quantifies the strength of the relationship between the variables in a correlation analysis, Mean absolute error (MAE), errors between paired observations, Root mean squared error (RMSE), is the square root of the mean of the square of all of the error. RMSE is a good measure to compare prediction errors of different models, Relative absolute error (RAE) which is the magnitude of the difference between the exact value and the approximation, and Root relative squared error (RRSE) that is relative to what it would have been if a simple predictor had been used. The data in the dataset have been randomly divided into 70% training and 30% testing.

3. RESULTS

The results of the investigation are given in Table 2. According to the results, M5P resulted in the highest CC, while REPTree was most successful in the other parameters. The M5P was followed by AMT, DS, RF, and REPTree in the CC. Figure 2 and Eq (1) present the tree models of M5P and REPTree. While REPTree uses SI – 8, SI – 1, and SI – 5 in the tree decision, M5P uses SI – 3, SI – 5, and SI – 7 in the model equation, where SI – 5 has the highest weight. Using the two models, soil salinity prediction can be made and visualized.

Table 2. Results of the investigated tree algorithms

Method	CC	MAE	RMSE	RAE	RRSR
RF	0.83	3.23	4.27	70.56	83.31
AMT	0.88	3.72	4.05	81.39	79.04
M5P	0.92	3.44	3.73	75.29	72.81
REPTree	0.82	2.41	2.97	52.70	57.97
DS	0.84	3.40	4.43	74.28	86.33

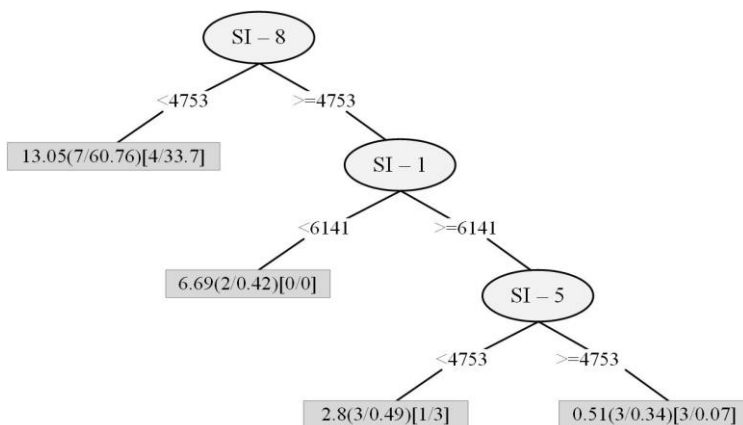

Figure 1. Results of REPTree; tree construction

The values on the lines connecting nodes reflect the splitting criterion depending on the parent node feature values. The value before the parentheses in the leaf node represents the categorization value. In addition, the first value in the first parenthesis represents the total number of cases from the training set in that leaf. In contrast, the second value represents the number of instances improperly categorized in that leaf. The first value in the second parenthesis, on the other hand, is the total number of occurrences from the pruning set in that leaf. The second value is the number of instances in that leaf that were mistakenly categorized.

The M5P model uses a smoothed linear model. With one rule, the results showed a significantly high correlation. The rule is presented in Eq. 1. Using Eq. 1, a soil salinity prediction map has been produced, shown in Figure 3.

$$EC = -0.0027 \times SI3 - 68.8814 \times SI5 + 0.0033 \times SI7 + 80.1276 \quad (1)$$

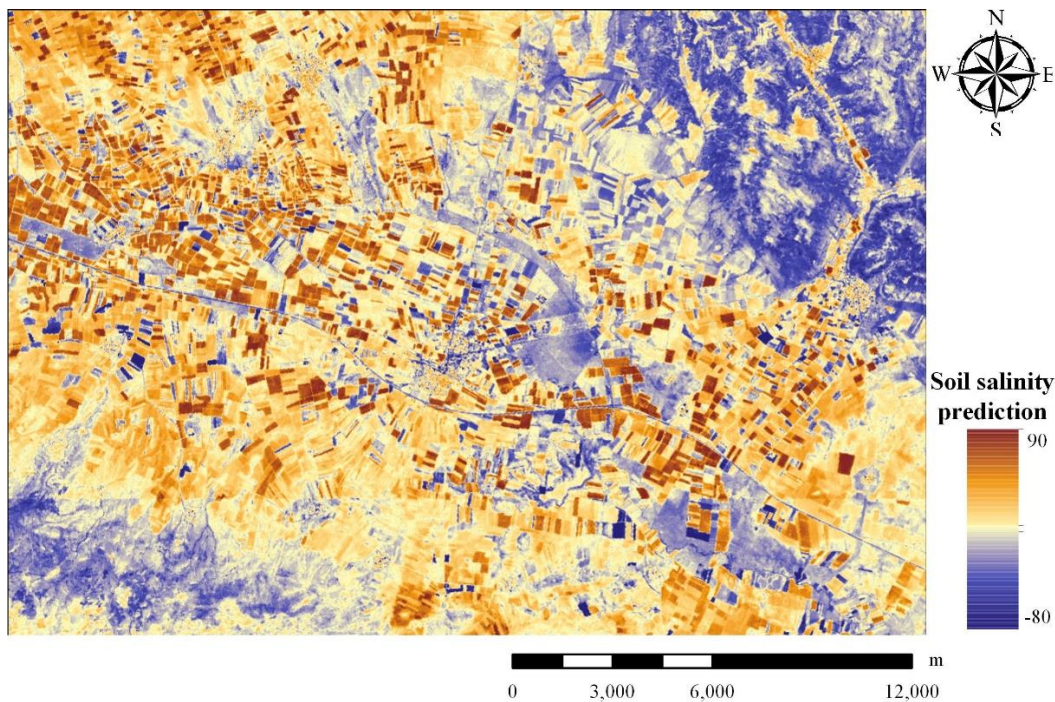

Figure 2. *Soil salinity prediction map*

4. DISCUSSION

Salinity is one of the most critical problems for agricultural lands lost due to wrong operations in our world. Especially in arid and semiarid regions, approximately half of the irrigated agricultural lands have salinity problems of varying degrees—good protection of limited resources and especially agricultural lands against the rapidly increasing world population. Therefore, soil salinity should be monitored with fast, economic and accurate data and methods. The fact that on-site measurements require much time and are not economical makes monitoring salinity with remotely sensed data advantageous.

In this study, soil salinity was estimated using remotely sensed data and machine learning algorithms, and the method with the best results was determined. In this direction, five different machine learning algorithms were used. Results show that the REPTree and M5P methods gave the best results. In other studies in the literature, it is seen that these algorithms give very successful results [29]. It is also stated that it is an advantage in that it is a flexible method and gives the best results in estimation processes in different fields [30].

In addition, it has been noticed that the SI5 index is used for estimation in both methods. SI5 can be used to estimate salinity in terms of both ease of calculation and performance. It is seen that this index, which is calculated by the ratio of the blue and green bands of the PlanetScope satellite, also gives successful results in salinity studies calculated by statistical methods [31].

The results show that machine learning algorithms and PlanetScope images successfully determine soil salinity. The methods will be evaluated in future studies by taking samples from different product classes and wet/arid lands.

5. CONCLUSION

Soil salinity caused by global climate change, which the Paris Climate Agreement often raises, has reached dangerous levels. In addition to its environmental effects, soil salinity has become a factor that causes soil fertility to decrease and restricts the economic gain obtained from agricultural activities. Accordingly, the studies conducted to determine, monitor, manage soil salinity in the Central Anatolia Region of Turkey, the economy based on agricultural activities, and restore the regions affected by soil salinity have gained significant importance. For this reason, it is very advantageous to monitor soil salinity with the use of remotely sensed data in a fast, economical, and not very time-consuming. In this study, soil salinity was estimated using machine learning algorithms with remotely detected data of agricultural areas of the Alpu district, where agricultural activities are carried out intensively in the Central Anatolia Region, and the methods that give the

algorithms with remotely detected data of agricultural areas of the Alpu district, where agricultural activities are carried out intensively in the Central Anatolia Region, and the methods that give the best results were selected. Five different machine learning algorithms were used to determine soil salinity. Among these five algorithms, it has been determined that the REPTree and MSP methods, which have given very successful results in the literature, give the best results. In addition to the fact that the methods give better results in estimating soil salinity in different areas, they are also quite a flexible method. Additionally the SI5 index, which is common to both methods used to estimate soil salinity, supports its availability both for the convenience of estimating and for performance. As a result, it was determined that machine learning algorithms and PlanetScope images were successfully used to determine the soil salinity.

Further research is needed to test the potential of machine learning algorithms in estimating and mapping soil salinity. Also, machine learning algorithms used to estimate soil salinity should be studied in vast areas with different climates, geology, geomorphology, land use, and vegetation to evaluate their potential for use in different areas.

ACKNOWLEDGMENT

This study was supported by Eskisehir Technical University Scientific Research Projects Commission under grant no: 19ADP084.

LITERATURE

- [1] Asfaw, E.; Suryabhadgavan, K.; Argaw, M. Soil salinity modeling and mapping using remote sensing and gis: The case of wonji sugar cane irrigation farm, ethiopia. *Journal of the Saudi Society of Agricultural Sciences* 2018, 17, 250-258.
- [2] Li, H.; Webster, R.; Shi, Z. Mapping soil salinity in the yangtze delta: Reml and universal kriging (e-blup) revisited. *Geoderma* 2015, 237, 71-77.
- [3] Gorji, T.; Sertel, E.; Tanik, A. Monitoring soil salinity via remote sensing technology under data scarce conditions: A case study from turkey. *Ecological Indicators* 2017, 74, 384-391.
- [4] Allbed, A.; Kumar, L. Soil salinity mapping and monitoring in arid and semi-arid regions using remote sensing technology: A review. *Advances in remote sensing* 2013, 2013.
- [5] Taghadosi, M.M.; Hasanlou, M.; Eftekhari, K. Retrieval of soil salinity from sentinel-2 multispectral imagery. *European Journal of Remote Sensing* 2019, 52, 138-154.
- [6] El Harti, A.; Lhissou, R.; Chokmani, K.; Ouzemou, J.-e.; Hassouna, M.; Bachaoui, E.M.; El Ghmari, A. Spatiotemporal monitoring of soil salinization in irrigated tadla plain (morocco) using satellite spectral indices. *International Journal of Applied Earth Observation and Geoinformation* 2016, 50, 64-73.
- [7] Peng, J.; Biswas, A.; Jiang, Q.; Zhao, R.; Hu, J.; Hu, B.; Shi, Z. Estimating soil salinity from remote sensing and terrain data in southern xinjiang province, china. *Geoderma* 2019, 337, 1309-1319.
- [8] Corwin, D.; Scudiero, E. Review of soil salinity assessment for agriculture across multiple scales using proximal and/or remote sensors. *Advances in agronomy* 2019, 158, 1-130.
- [9] Liu, Y.; Zhang, F.; Wang, C.; Wu, S.; Liu, J.; Xu, A.; Pan, K.; Pan, X. Estimating the soil salinity over partially vegetated surfaces from multispectral remote sensing image using non-negative matrix factorization. *Geoderma* 2019, 354, 113887.
- [10] Elhag, M. Evaluation of different soil salinity mapping using remote sensing techniques in arid ecosystems, saudi arabia. *Journal of Sensors* 2016, 2016.
- [11] Wang, S.; Chen, Y.; Wang, M.; Li, J. Performance comparison of machine learning algorithms for estimating the soil salinity of salt-affected soil using field spectral data. *Remote Sensing* 2019, 11, 2605.
- [12] Ahmad, S.; Kalra, A.; Stephen, H. Estimating soil moisture using remote sensing data: A machine learning approach. *Advances in water resources* 2010, 33, 69-80.
- [13] Wang, J.; Wang, W.; Hu, Y.; Tian, S.; Liu, D. Soil moisture and salinity inversion based on new remote sensing index and neural network at a salina-alkaline wetland. *Water* 2021, 13, 2762.
- [14] Habibi, V.; Ahmadi, H.; Jafari, M.; Moeini, A. Quantitative assessment of soil salinity using remote sensing data based on the artificial neural network, case study: Sharif abad plain, central iran. *Modeling Earth Systems and Environment* 2021, 7, 1373-1383.

- [15] Wang, J.; Peng, J.; Li, H.; Yin, C.; Liu, W.; Wang, T.; Zhang, H. Soil salinity mapping using machine learning algorithms with the sentinel-2 msi in arid areas, china. *Remote Sensing* 2021, *13*, 305.
- [16] Wu, W.; Zucca, C.; Muhaimed, A.S.; Al-Shafie, W.M.; Fadhil Al-Quraishi, A.M.; Nangia, V.; Zhu, M.; Liu, G. Soil salinity prediction and mapping by machine learning regression in central mesopotamia, Iraq. *Land degradation & development* 2018, *29*, 4005-4014.
- [17] Wang, N.; Xue, J.; Peng, J.; Biswas, A.; He, Y.; Shi, Z. Integrating remote sensing and landscape characteristics to estimate soil salinity using machine learning methods: A case study from southern xinjiang, china. *Remote Sensing* 2020, *12*, 4118.
- [18] Taşpınar, K.; Ateş, Ö.; Özge Pınar, M.; Yalçın, G.; Kızılaslan, F.; Fidantemiz, Y.F. Soil contamination assessment and potential sources of heavy metals of alpu plain eskişehir turkey. *International Journal of Environmental Health Research* 2021, 1-9.
- [19] Derakhshandeh, M.; Tombul, M. Calibration of metric modeling for evapotranspiration estimation using landsat 8 imagery data. *Water Resources Management* 2021, 1-25.
- [20] Khan, N.M.; Rastoskuev, V.V.; Sato, Y.; Shiozawa, S. Assessment of hydrosaline land degradation by using a simple approach of remote sensing indicators. *Agricultural Water Management* 2005, *77*, 96-109.
- [21] Nicolas, H.; Walter, C. Detecting salinity hazards within a semiarid context by means of combining soil and remote-sensing data. *Geoderma* 2006, *134*, 217-230.
- [22] Bannari, A.; Guedon, A.; El-Harti, A.; Cherkaoui, F.; El-Ghmari, A. Characterization of slightly and moderately saline and sodic soils in irrigated agricultural land using simulated data of advanced land imaging (eo-1) sensor. *Communications in soil science and plant analysis* 2008, *39*, 2795-2811.
- [23] Khan, S.; Abbas, A. Using remote sensing techniques for appraisal of irrigated soil salinity. *Int. Congr. Model. Simul.(MODSIM), Model. Simul. Soc. Aust. New Zealand, Bright* 2007, 2632-2638.
- [24] Zhu, X.X.; Tuia, D.; Mou, L.; Xia, G.-S.; Zhang, L.; Xu, F.; Fraundorfer, F. Deep learning in remote sensing: A comprehensive review and list of resources. *IEEE Geoscience and Remote Sensing Magazine* 2017, *5*, 8-36.
- [25] Quinlan, J.R. In *Learning with continuous classes*, 5th Australian joint conference on artificial intelligence, 1992; World Scientific: pp 343-348.
- [26] Blaifi, S.-a.; Moulahoum, S.; Benkercha, R.; Taghezout, B.; Saim, A. M5p model tree based fast fuzzy maximum power point tracker. *Solar Energy* 2018, *163*, 405-424.
- [27] Frank, E.; Mayo, M.; Kramer, S. In *Alternating model trees*, Proceedings of the 30th annual ACM symposium on applied computing, 2015; pp 871-878.
- [28] Patel, R.R.; Aluvalu, R. A reduced error pruning technique for improving accuracy of decision tree learning. *International Journal of Engineering and Advanced Technology (IJEAT)* 2014, *3*, 8-11.
- [29] Wang, F.; Shi, Z.; Biswas, A.; Yang, S.; Ding, J. Multi-algorithm comparison for predicting soil salinity. *Geoderma* 2020, *365*, 114211.
- [30] Sepahvand, A.; Singh, B.; Sihag, P.; Nazari Samani, A.; Ahmadi, H.; Fiz Nia, S. Assessment of the various soft computing techniques to predict sodium absorption ratio (sar). *ISH Journal of Hydraulic Engineering* 2019, 1-12.
- [31] Avdan, U.; Kaplan, G.; AVDAN, Z.Y.; MATÇI, D.K.; ERDEM, F.; MIZIK, E.; Ozudogru, I. Comparison of remote sensing soil electrical conductivity from planetscope and ground measured data in wheat and beet yields. 2021.

04

Research paper | Оригинални научни рад
DOI 10.7251/STP2215028S
ISSN 2566-4484



Jakob Šušteršič, IRMA Institute for Research in Materials and Applications, Slovenia
jakob.sustersic@irma.si

Rok Ercegovič, IRMA Institute for Research in Materials and Applications, Slovenia
rok.ercegovic@guest.arnes.si

David Polanec, IRMA Institute for Research in Materials and Applications, Slovenia
david.polanec@irma.si

RESISTANCE TO CRACK PROPAGATION OF HIGH-PERFORMANCE CONCRETE

Abstract

This paper discusses the results of investigations on the resistance to crack propagation carried out as part of a large-scale project to develop high-performance concretes (HPCs) for the secondary lining of a low and intermediate level waste disposal shaft. Four HPCs were investigated, in which the quantity of the binder component and the proportions of the two cements and the silica fume in it were varied. We have also added steel fibers to one HPC. The wedge splitting test method was used to determine the resistance to crack propagation. The results obtained show that all the HPC investigated achieve good resistance to crack propagation. The addition of steel fibers further improves this resistance.

Keywords: resistance to crack propagation, high performance concrete, wedge splitting test

OTPORNOST BETONA VISOKIH PERFORMANSI NA ŠIRENJE PUKOTINA

Сажетак

У овом раду се разматрају резултати истраживања отпорности на ширење пукотина спроведених у оквиру обимног пројекта развоја бетона високих перформанси (БВП) за секундарну облогу шахта за одлагање ниско и средње радиоактивног отпада. Истраживали смо четири састава БВП, у којима смо углавном варирали количину везивне компоненте и међусобне односе два цемента и силикатне прашине. Такође смо додали челична влакна у један БВП. За одређивање отпорности на ширење пукотине коришћена је метода испитивања цепања клином. Добијени резултати показују да сви испитивани БВП постижу добру отпорност на ширење пукотине. Додатак челичних влакана додатно побољшава ову отпорност.

Кључне ријечи: отпорност на ширење пукотина, бетон високих перформанси, испитивање цепања клином

1. INTRODUCTION

High performance concrete (HPC) differs from normal concrete in at least one individual property (compressive strength, permeability, workability or other), and in structure, composition, and production [1]. Research during the 1970s, highly effective plasticizers or superplasticizers for concrete, introduced the possibility of significantly reducing the value of w/c ratio and achieving, regardless of the moderate content of cement, a high degree of workability. The low value of the w/c ratio, with good compaction, has a significant contribution to high strengths. Strength was an important parameter in distinguishing HPC from normal concrete.

In the 1950s, the compressive strength of concrete was considered to be 35 MPa high strength [2]. In the 1960s, concretes with compressive strengths of up to 40 and 50 MPa were used. The European Standard for Concrete EN 206:2013 defines in clause 4.3.1 "Compressive strength classes" in Table 12 "Compressive strength classes for normal and heavy concrete", ending at compressive strength class C 100/115, and Table 13 "Compressive strength classes for lightweight concrete", ending at compressive strength class LC 80/88. The tables are identical to those in the previous edition of EN 206-1:2003. Neither of the two editions of the concrete standard gives any rules for high strength concretes. It should be noted that the old edition of EN 206-1:2003, among the definitions in Chapter 3 "Definitions, symbols and abbreviations", clause 3.1.10 defined that high strength concretes are normal concretes of strength class C 55/67 and above and lightweight concretes of strength class LC 50/55 and above. This definition is not in the new edition of EN 206:2013.

Strengths up to 150 MPa were a sensation [3]. Using special technologies and materials, in laboratories and in experimental productions, compressive strengths of 230 MPa and 460 MPa [2] and up to 800 MPa and more have been achieved [4], so-called concretes with reactive powder RPC (Reactive Powder Concrete) [5, 6]. The first applications of high - strength concretes were recorded during the construction of highly loaded columns of tall buildings (skyscrapers) [7, 8].

Over time, it became known that high-strength concrete improves other properties, such as abrasion resistance, capillary absorption, gas permeability and water permeability, diffusion resistance, resistance to freezing-thawing in the presence of de-icing salts, etc. Due to these improvements, the term high performance concrete (HPC) [9] was introduced. The HPC concept has been extended to fresh concrete, so that self-consolidating concrete (SCC) [10] is also considered HPC.

High strength concrete is achieved by maximizing the densification of the structure of the hardened cement paste and the densification of the transition zone of the interfaces between the hardened cement paste and the aggregate grains. First, we need to achieve a good "packing" of the aggregate grains [11], or a compacted aggregate structure that is "glued" with cement paste.

Mineral admixtures as well as polymers are very often used to achieve the densest structure of the hardened cement paste and the most dense transition zone. In this case, we are not talking about a water-cement (w/c) ratio, but a water-binder (w/b) ratio. By increasing the quantity of mineral admixtures and decreasing the w/b ratio, higher concrete strength is achieved. But often, increasing the quantity of mineral admixtures increases the need for water. In such a case, when the critical quantity of a given mineral admixture is exceeded, the strength of the concrete is reduced because the w/b ratio is increased. Therefore, when mineral admixtures are used, highly effective plasticizers are added to the concrete to evenly distribute the fine particles of the mineral admixture and reduce the amount of water, thus increasing the strength of the concrete. In any case, the amount of mineral admixtures is also limited for other reasons, which were discussed at much more detail at the 22nd Slovenian Colloquium on Concretes: Use of mineral admixtures in cement and/or concrete [12].

Typically, the w/b ratio values of high-strength concretes are between 0,25 and 0,40. At such low w/b ratios, not all the binding component (cement and mineral admixtures) hydrates. The lower the w/b ratio, the more non-hydrated particles there are, the density increases and the strength of the concrete increases [13]. Non-hydrated cement and mineral additive particles act as a mineral filler.

Hardened cement paste binds the aggregate grains together. Physical interactions are mainly dominant and chemical bonding is rare. On the surfaces of the aggregate grains, crystals grow from the highly saturated solution, i.e., calcium-hydroxyl lamellae. Investigations show that conventional cement paste produces a porous layer with a crystalline orientation on the surfaces of the aggregate grains, with a thickness of about 40 μm . This layer has a lower hardness and strength than hardened cement paste. Investigations show that the thickness of the transition zone is difficult to influence by varying the w/c ratio, like the average aggregate grain spacing in concrete, which is approximately 75 to 100 μm [14]. As a consequence, the mechanical properties of concrete are highly dependent on the transition zone. SEM photos [15] show that there is a dense, irregular zone with a thickness of 1 μm on the surface of the aggregate grains. This zone is followed by a porous transition zone about 10 μm thick.

It can be observed that the porosity of the transition zone decreases as the concrete hardens, while that of the compact cement paste remains relatively constant. However, the transition zone can be significantly densified by adding mineral admixtures. Silica fume is the most effective because the small particles increase the volume around the cement particle and, due to their large specific surface area, hydrate significantly faster than fly ash or slag. In addition, CH is transformed into CSH, reducing the amount of CH crystals at the interface between the hardened cement paste and the aggregate grains.

The reduction of porosity, or densification of the transition zone by mineral admixtures, greatly reduces the possibility of cracks forming during the application of external loads at the interface between the hardened cement paste and the aggregate grains. This increases the strength of the concrete.

The influence of the good bond between the hardened cement paste and the aggregate grains, or the densified transition zone due to the addition of silica fume, can be seen in the photographs in Figure 1, which show the surfaces of the concrete test specimens (cubes) after the wedge splitting test [16].

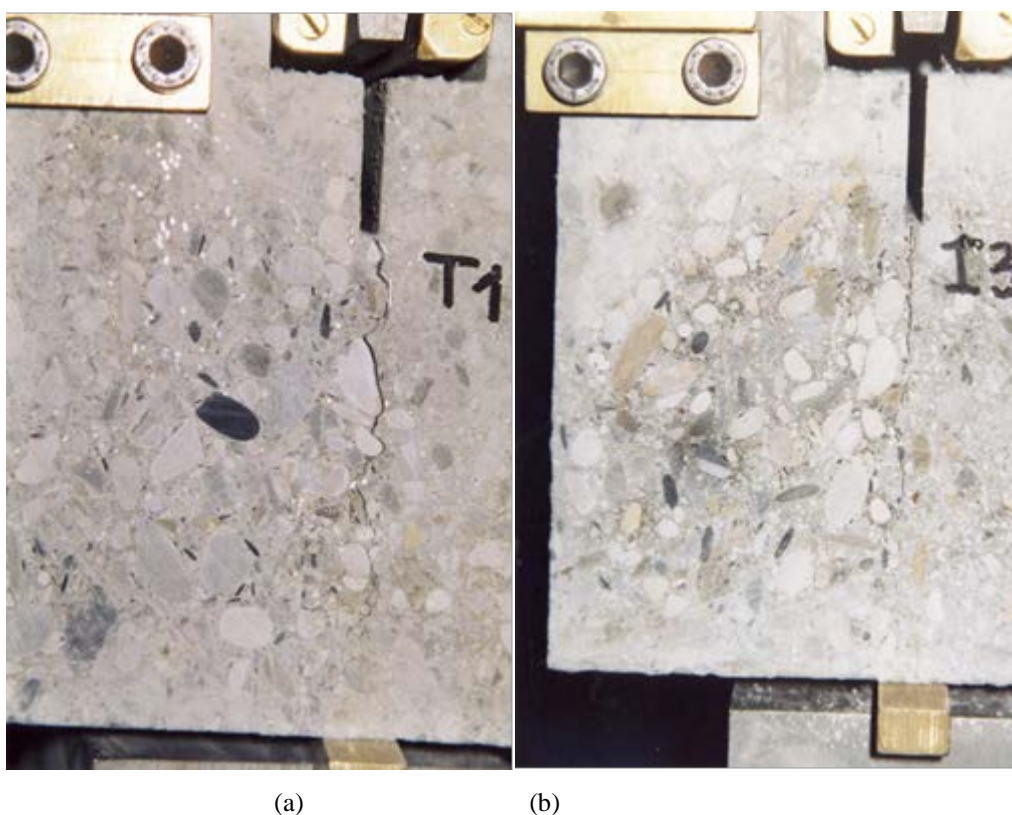

Figure 1. Surface photographs of concrete cubes after wedge splitting test: (a) concrete without mineral admixture, (b) concrete with added silica fume [16].

The addition of silica fume (7,5 % w/w of cement) to the concrete - right picture (b) in Figure 1 - has densified the transition zones and they no longer represent the weak or porous regions in the concrete that would be the cause of the crack initiation and propagation. Also, the addition of silica fume makes the cement paste denser, which means that there are far fewer weak regions in the concrete where cracks would start to form. As the external load continues to be applied, these cracks join to form a single dominant crack, which ultimately leads to the concrete test specimen collapsing. In general, the propagation of cracks can be said to depend on the magnitude and duration of the stresses that caused their formation and the external loads. Concrete resists this expansion by bridging the cracks with aggregate grains and additionally, if present, with fibers or polymer. We are talking about the resistance of concrete to crack propagation, or the ability of concrete to absorb as much energy as possible up to a certain (chosen) crack width.

The method for determining the resistance to crack propagation (RCP) of concrete and the results of extensive RCP investigations of high-performance concretes (HPC) are presented below.

2. METHOD FOR DETERMINING THE RESISTANCE TO CRACK PROPAGATION

The resistance to crack propagation of concrete is determined by the following equation:

$$RCP = \frac{f_{ct}}{f_{cw}} \quad (1)$$

where:

RCP - resistance to crack propagation,

f_{ct} - ultimate splitting tensile strength (MPa),

f_{cw} - equivalent splitting tensile strength up to the selected crack width (MPa).

In practice, the equivalent splitting tensile strength up to a crack width of 0.2 mm ($f_{0,2}$) is most used to calculate the resistance of concrete to crack propagation, and equation (1) takes the following form [21]:

$$RCP = \frac{f_{ct}}{f_{0,2}} \quad (2)$$

where:

RCP - resistance to crack propagation,

f_{ct} - ultimate splitting tensile strength (MPa),

$f_{0,2}$ - equivalent splitting tensile strength up to the crack width of 0,2 mm (MPa).

From the load - CMOD (Crack Mouth Opening Displacement) diagrams, the ultimate splitting tensile strength (f_{ct}) and the equivalent splitting tensile strengths up to crack widths $CW = 0,1, 0,2, 0,3$ and $0,4$ mm (f_{cw}) are determined or calculated. The load - CMOD diagram was obtained during the wedge splitting test of concrete. The wedge splitting test (WST) method, which produces a load - CMOD diagram, is one of many test methods that have been developed to determine the behavior of cement-based composites in the cracked state. The WST method we use was developed by Tschegg and Linsbauer [17-20] and is briefly described below.

A test specimen (cube) with a rectangular groove and a notch at the bottom of the groove is placed on a flat linear support in a compression testing machine (Figure 2). The two transfer pieces inserted in the groove cause the test specimen to split by pushing the wedge in.

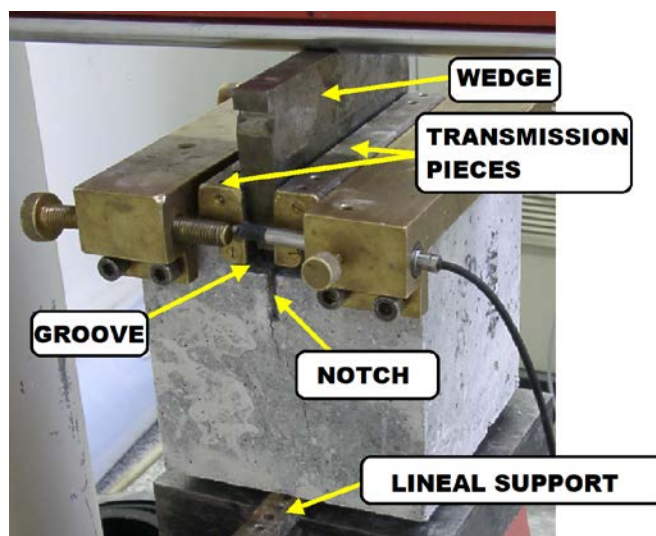

Figure 2. Individual components of the wedge splitting test device.

The force F (Figure 3) caused by the compression testing machine is transmitted by the wedge to the test specimen by dividing it into two components. The larger horizontal component F_H splits the test specimen.

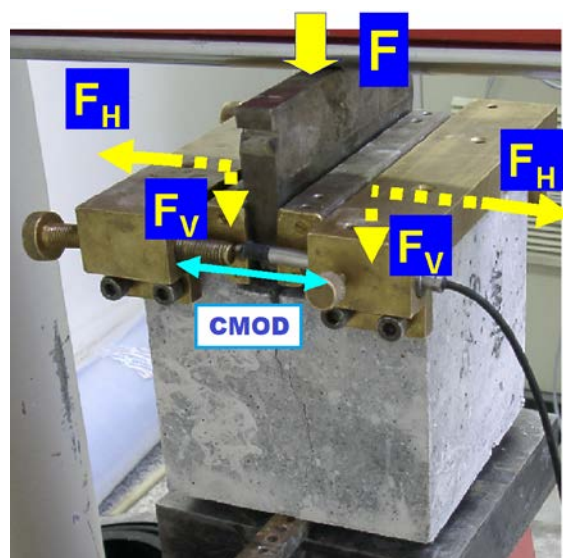

Figure 3. Principle of the wedge split test method.

The smaller vertical component F_V helps to control the direction of crack propagation in the plane connecting the support and the notch. As the wedge angle is small, the F_V component does not affect the test results. The deformation is determined by measuring the Crack Mouth Opening Displacement (CMOD) in the line of action of the F_H component during splitting of the test specimen.

During the application of a load to the test specimen, small individual cracks within the concrete begin to appear at a given load. These cracks join to form a continuous crack that can be seen on the surface of the test specimen. At this point in the load - CMOD diagram, the slope of the diagram increases sharply. The load and CMOD at this point are referred to as the load at the first crack F_{fc} and the Crack Mouth Opening Displacement at the first crack $CMOD_{fc}$, respectively.

There are difficulties relating to precise determination of the location of the first crack (FC). ASTM C 1018 defines first crack as the point on the load - CMOD diagram at which the form of the curve first becomes non-linear. Determination of the point of FC has been proposed [22, 23] as the point at which the slope of the curve departs from linearity by more than 5 % and lasts for an interval of more than 0,01 mm.

At our Institute (IRMA), computer program has been developed, which works in graphical form, for automatically drawing load - CMOD curves, for calculation of parameters for evaluation of concrete behavior, and for determination of the point of FC [24].

At the moment when the point FC is reached, the crack width begins to propagate with further loading. From the point FC, the fracture zone of the concrete begins to form. In the fracture zone, all further fracture processes proceed until the final separation of the test specimen.

3. EXPERIMENTAL BASIS

3.1. SHORT INTRODUCTION TO THE PROJECT

The project that we are briefly reviewing here is entitled "Study on the production, placeability and characteristics of final concrete mixtures for the construction of secondary reinforced concrete lining of the silo of the LILW repository" [25]. The project was carried out at the Institute for Research in Materials and Applications (IRMA), in the laboratory and in the test field. The implementation was carried out by the laboratories of the Slovenian National Building and Civil Engineering Institute (ZAG), the Faculty of Civil and Geodetic Engineering of the University of Ljubljana, the Geological Survey of Slovenia, Salonit Anhovo and the Faculty of Civil Engineering of the University of Zagreb. HSE Invest and IBE, the designer of the LILW repository, worked together on specific areas of expertise. During the implementation of the project, we worked closely with the project sponsor, the Agency for Radioactive Waste (ARAO).

The project was implemented in three phases. The results and findings of each phase served as a basis for the continuation of the project in the next phase. So, in the first phase, we selected the basic materials and carried out preliminary tests on the concretes. Based on the results obtained, four optimum concrete mix-proportions were identified and tested in the laboratories as part of the second

phase. We investigated the properties of fresh and hardened concretes relevant for achieving extremely high concrete durability and service life of the secondary lining and, indirectly, of the entire LILW silo. These results were confirmed by measurements and investigations in the test field during the first part of the third phase of the project. The measurements and investigations in the test field also provided new results and findings, which were used to develop the basic technological parameters for the construction of the secondary reinforced concrete lining of the silo of the LILW repository. These were prepared as part of the second part of the third phase of the project.

3.2. SELECTION OF BASIC MATERIALS AND IDENTIFICATION OF CONCRETE MIX-PROPORTIONS

3.2.1. Binder

The selection of the binder was based on the key required characteristics of the concrete:

- high compressive strength,
- low development of hydration heat,
- low permeability,
- sulphate resistance,
- extremely high durability of the concrete and the service life of the completed structure.

There is no such binder on the market that meets the above requirements. Therefore, we selected a binder component consisting of two cements (CEM I 42,5 N SRO and CEM III/B 32,5 N - LH/SR) and Silica Fume (SF).

3.2.2. Aggregate

The gravels from the Lower Sava separations, which are located close to the LILW disposal site, are not an option due to the presence of coal grains. Dolomite or limestone crushed aggregate have been proposed as possible aggregate types. Based on a literature review of the findings of several studies of concretes with dolomite and limestone aggregate, we chose limestone aggregate, mainly because of the potential for an alkali-dolomite reaction in concrete with dolomite aggregate at high concrete ages. The concretes investigated in this project were prepared using crushed quarry aggregate of carbonate origin with more than 96% limestone or calcium carbonate.

3.2.3. Chemical admixtures

The selection of the chemical admixtures was carried out in the framework of preliminary tests of the concretes regarding workability and air content of the fresh concrete.

3.2.4. Steel fibers

To obtain the optimum concrete mix-proportion according to the given criteria, the mix-proportions were modified by the addition of steel fibers. To minimize the effect of the fibers on the workability of the fresh concrete and to maximize the uniform distribution of fibers in the fresh concrete mass, short (16 mm long) and thin (0,4 mm thick) steel fibers with anchors at the ends were selected to allow good anchorage in the hardened concrete matrix.

3.2.5. Concrete mix-proportions

Based on the results of the preliminary investigations, four mix-proportions of concrete or High-Performance Concrete (HPC), respectively (Table 1) were determined, which were investigated in the laboratories during the second phase of the project, placed in the test field and investigated during the first part of the third phase.

Table 1. Mix-proportions of High-Performance Concrete (HPC)

Parameter	Unit	Designations of HPC			
		PP-1	PP-1-JV	PP-2	PP-3
Binder (CEM I + CEM III + SF)	(kg/m ³)	405	405	405	425
CEM I / CEM III	-	0,43	0,43	1,00	1,00
Hyper-plasticizer	(% m/m)	0,47	0,47	0,47	0,78
Antifoaming admixture	(% m/m)	1,00	1,00	1,00	1,00
(w/b) _{eff.design}	-	0,38	0,38	0,38	0,38
Steel fibers	(% v/v)	-	0,77	-	-
D _{max} of limestone aggregate	(mm)	32	32	32	32

3.3. OVERVIEW OF THE RESULTS OF SOME PROPERTIES OF HARDENED HPC

In this section, we would like to provide additional information on only some of the properties of all four HPCs that sufficiently represent their characteristics.

3.3.1. Compressive strength

The compressive strength according to SIST EN 12390-3:2009 of the hardened HPC was tested at ages 1, 2, 3, 7, 28, 56 and 154 days. Figure 4 shows the average compressive strength results as a function of the age of the HPC.

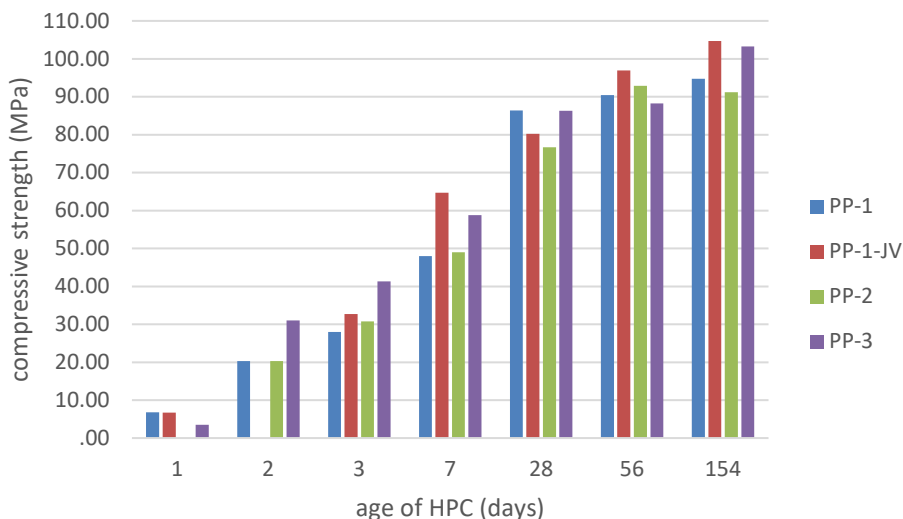

Figure 4. Average compressive strength values as a function of HPC age.

The project requires a compressive strength class of C60/75 at 90 days. As we have not been able to determine the compressive strength of the HPC at 90 days of age, we give an estimate of the compressive strength class achieved at 56 and 154 days of age. The assessment (according to SIST EN 206:2013, Appendix A) shows that all HPCs meet the criteria of the required compressive strength class C60/75 at 56 and 154 days of age, which means that they also meet this criterion at 90 days. PP-1-JV and PP-3 also meet the criteria for the higher class C70/85 at 154 days of age.

3.3.2. Static modulus of elasticity

Static modulus of elasticity tests was carried out according to DIN 1048-5:1991 at HPC ages of 7, 28, 56 and 90 days. Figure 5 shows the average results of the static modulus of elasticity as a function of the age of the HPC.

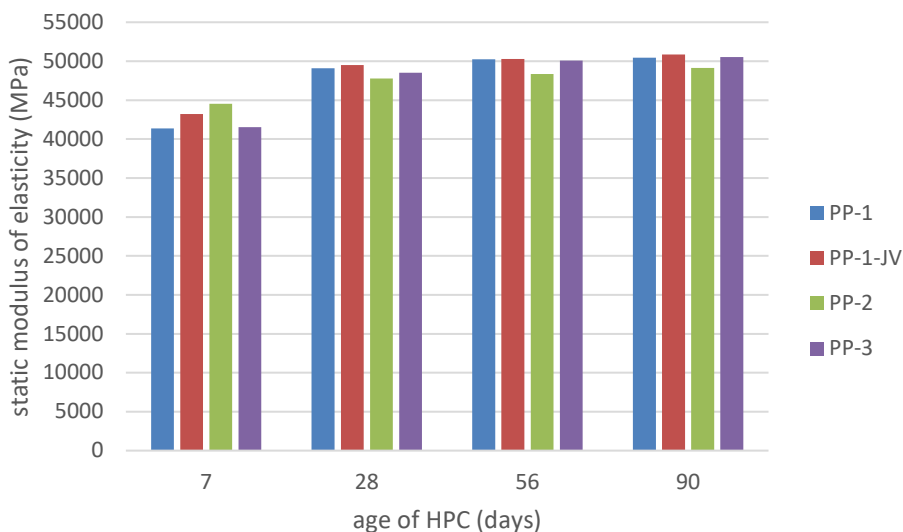

Figure 5. Average static modulus of elasticity as a function of HPC age.

The average test results of all HPC at 28 days of age meet the criterion ($E_{stat,28} \leq 50000$ MPa). At ages 56 and 90 days, the E_{stat} values increase only slightly and are slightly greater than 50000 MPa for PP-1, PP-1-JV and PP-3. For PP-2, the E_{stat} is < 50000 MPa even at age 90 days.

3.3.3. Resistance to water penetration

Water penetration tests according to SIST EN 12390-8.2009 were carried out at HPC ages of 7, 28, 56 and 90 days. Figure 6 shows the average results of the water penetration tests as a function of the age of the HPC.

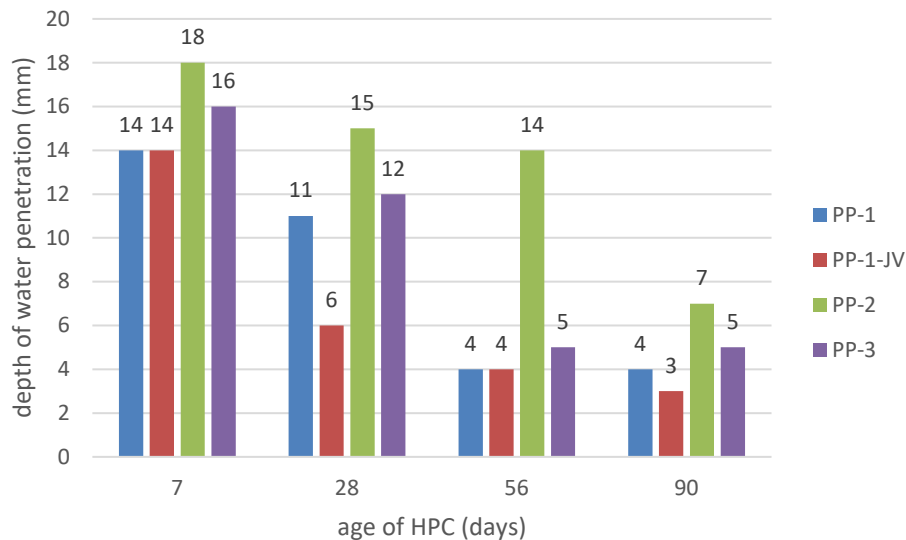

Figure 6. Average depth of water penetration as a function of HPC age.

The following project requirements are given:

- maximum average allowed depth of water penetration: $e_{aver,allow} = 10$ mm,
- maximum individual allowed result: $e_{max,allow} = 15$ mm.

As HPC increase in age, their resistance to water penetration increases. PP-1-JV already meets the required criterion at 28 days of age, PP-1 and PP-3 at 56 days of age and PP-2 only at 90 days of age.

3.3.4. Internal freeze/thaw resistance

The internal freeze/thaw resistance test is performed at HPC ages 56 and 90 days according to SIST 1026:2016, Appendix ND. In Table 2, we report the average and minimum relative dynamic modulus of elasticity after n freeze/thaw cycles of all four HPC mixtures that we started testing at ages 56 and 90 days.

Table 2. Average and minimum relative dynamic modulus of elasticity after n freeze/thaw cycles.

HPC	Age of HPC at start of test (days)	Number of cycles n	Relative dynamic modulus of elasticity	
			Average (%)	Minimum (%)
PP-1	56	375	95,8	92,1
	90	325	97,4	97,0
PP-1-JV	56	375	98,1	97,7
	90	300	98,8	98,5
PP-2	56	375	96,8	92,1
	90	300	97,4	95,5
PP-3	56	350	99,9	98,9
	90	275	99,0	98,4

Although the required criterion for internal freeze/thaw resistance is up to 200 cycles, all HPCs were tested up to n cycles (see Table 2). Even after n cycles, all HPCs met the criterion: average relative

dynamic modulus of elasticity > 80% and minimum relative dynamic modulus of elasticity > 75%. Based on these results, it can also be roughly estimated that all four HPCs have a quality structure that can assure the long service life of the LILW repository.

3.3.5. Resistance to chloride diffusion

The resistance to chloride diffusion test according to the method given in NT BUILD 492:1999 was carried out at HPC ages 56 and 90 days. Table 3 gives the results of the average chloride diffusion coefficients.

Table 3. Average coefficients of chloride diffusion.

HPC	$D_{nssm}, \times 10^{-12} \text{ m}^2/\text{s}$	$D_{nssm}, \times 10^{-12} \text{ m}^2/\text{s}$
	Age of HPC 56 days	Age of HPC 90 days
PP-1	$0,77 \pm 0,28$	$0,55 \pm 0,05$
PP-1-JV	$1,48 \pm 0,23$	$1,01 \pm 0,18$
PP-2	$1,16 \pm 0,13$	$0,71 \pm 0,05$
PP-3	$0,86 \pm 0,09$	$0,68 \pm 0,10$

All HPCs meet the criterion for coefficient of chloride diffusion $D_{nssm} \leq 9,0 \cdot 10^{-12} \text{ m}^2/\text{s}$.

4. RESULTS OF RESISTANCE TO CRACK PROPAGATION TESTS AND DISCUSSION

All four HPCs were tested by the WST method described in section 2 at 3, 7, 28, 56 and 90 days of age. For each test specimen, we first determined the load – CMOD diagram. From the shape of the diagram, we can already assess the behavior of the test specimen during the application of the splitting load. As an example, we give in Figure 7 the typical load - CMOD diagrams determined for PP-1, PP-1-JV, PP-2 and PP-3 at their age of 90 days.

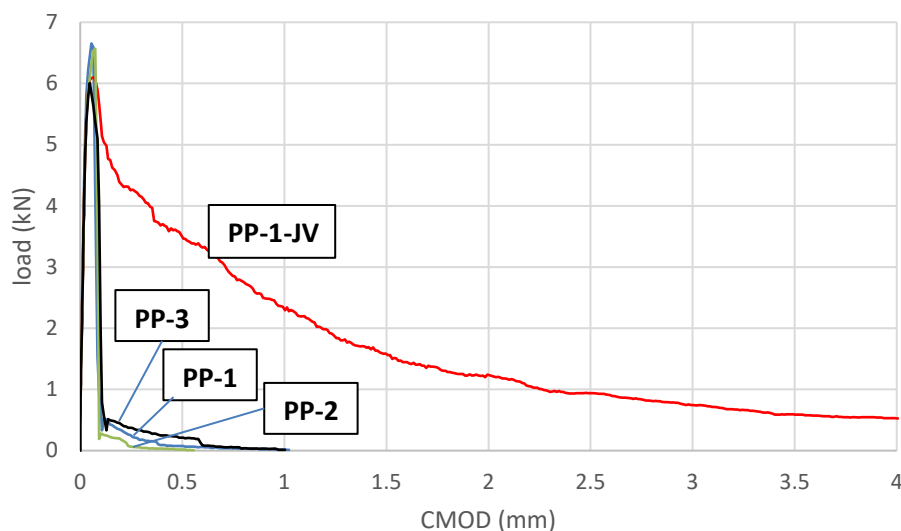

Figure 7. Typical load - CMOD diagrams of PP-1, PP-1-JV, PP-2 and PP-3 at 90 days of age.

We can immediately estimate that much more energy was absorbed during the PP-1-JV test compared to the other HPCs. This is understandable, of course, because PP-1-JV contains steel fibers, while the other HPCs are without fibers. A similar assessment can be made based on a visual inspection of the test specimens after the WST (Figure 8a, b, c). The cracks on test specimens PP-1 (a) and PP-3 (b) run more or less vertically to the lower edge - the cubes have split into two parts. While the cracks on the PP-1-JV (c) specimens are very branched and do not reach the lower edge of the cube. The cube does not break because the fibers bridge the crack and offer great resistance to crack propagation.



(a)



(b)



(c)

Figure 8. Crack shape and course after completion of WST on PP-1 (a), PP-3 (b) and PP-1-JV (c) specimens at 90 days of age.

The estimate described above is rough and relative. However, if we want to have a more accurate and measurably comparable estimate, we need to determine and calculate the parameters from the load - CMOD diagrams, as we have already described in section 2.

These parameters are:

- f_{ct} - ultimate splitting tensile strength,
- f_{fc} - splitting tensile strength at the first crack,
- f_{cw} - equivalent splitting tensile strength up to the crack width $CW = 0,1, 0,2, 0,3$ and $0,4$ mm,
- RCP (Resistance to Crack Propagation) = $f_{0,2}/f_{ct}$.

For all HPCs, we summarize the resulting parameters in Table 4 for PP-1, Table 5 for PP-1-JV, Table 6 for PP-2 and Table 7 for PP-3. For each table, the corresponding equivalent splitting tensile strengths f_{CW} versus crack width CW are given in graphical form.

Table 4. Results of the wedge splitting test for PP-1.

designation of the test specimen	age of PP-1 (days)	ultimate splitting tensile strength - f_{ct} (MPa)	splitting tensile strength at first crack - f_{fc} (MPa)	equivalent splitting tensile strength up to the crack width (mm)				resistance to crack propagation RCP= $f_{0,2}/f_{ct}$
				0,1	0,2	0,3	0,4	
	$f_{0,1}$	$f_{0,2}$	$f_{0,3}$	$f_{0,4}$	-			
PP-1/19	6	3,47	3,33	2,72	2,03	1,60	1,36	0,59
PP-1/20		3,78	3,54	3,28	2,51	2,01	1,67	0,66
PP-1/21		3,39	3,09	2,81	2,36	1,93	1,61	0,70
average		3,55	3,32	2,94	2,30	1,85	1,55	0,65
PP-1/22	8	4,22	3,94	3,64	2,69	2,00	1,60	0,64
PP-1/23		4,08	3,61	3,28	2,58	2,00	1,62	0,63
PP-1/24		4,38	4,15	3,46	2,88	2,36	1,97	0,66
average		4,23	3,90	3,46	2,72	2,12	1,73	0,64
PP-1/25	28	4,90	4,78	4,07	3,21	2,40	1,90	0,66
PP-1/26		4,94	4,78	4,36	3,40	2,60	2,11	0,69
PP-1/27		4,64	3,53	3,55	2,84	2,21	1,78	0,61
average		4,83	4,36	3,99	3,15	2,40	1,93	0,65
PP-1/28	56	5,71	5,32	4,68	3,92	3,03	2,34	0,69
PP-1/29		5,84	5,63	4,36	3,61	2,65	2,08	0,62
PP-1/30		5,45	5,16	4,65	3,81	2,85	2,25	0,70
average		5,67	5,37	4,56	3,78	2,84	2,22	0,67
PP-1/88	90	6,91	6,23	5,27	4,22	3,09	2,41	0,61
PP-1/89		6,35	5,74	4,36	3,93	2,85	2,24	0,62
PP-1/90		5,72	5,29	4,53	3,67	2,69	2,11	0,64
average		6,33	5,75	4,72	3,94	2,88	2,25	0,62

After the first crack, and as the crack width increases, the equivalent strengths decrease (Figure 9). This is known as softening. The increase in equivalent strengths at a given crack width is more moderate compared to the increase in f_{ct} (third column in the table 4) up to the age of PP-1 56 days. Thereafter, the equivalent strengths increase only slightly up to 90 days of age.

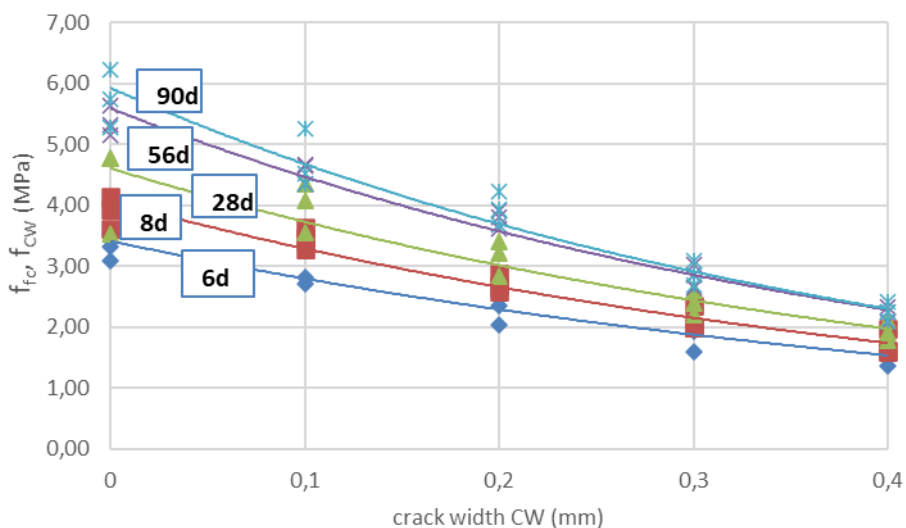

Figure 9. Equivalent splitting tensile strengths f_{CW} and splitting tensile strength at first crack f_{fc} of PP-1 as a function of crack width.

In the light of the above observation, a moderate increase in resistance to crack propagation RCP up to the age of PP-1 56 days is understandable, and then decreases at the age of 90 days (last column in Table 4). $RCP > 0.60$ at all ages PP-1.

Table 5. Results of the wedge splitting test for PP-1-JV.

designation of the test specimen	age of PP-1-JV (days)	ultimate splitting tensile strength - f_{ct} (MPa)	splitting tensile strength at first crack - f_{fc} (MPa)	equivalent splitting tensile strength up to the crack width (mm)				resistance to crack propagation $RCP=f_{0,2}/f_{ct}$
				0,1	0,2	0,3	0,4	
				$f_{0,1}$ (MPa)	$f_{0,2}$ (MPa)	$f_{0,3}$ (MPa)	$f_{0,4}$ (MPa)	
PP-1-JV/19	3	3,50	3,01	3,15	2,87	2,72	2,59	0,82
PP-1-JV/20		3,99	3,49	3,55	3,39	3,20	3,15	0,85
PP-1-JV/21		3,63	3,27	3,05	2,72	2,50	2,43	0,75
average		3,71	3,26	3,25	2,99	2,81	2,72	0,81
PP-1-JV/22	8	6,07	5,81	4,79	4,54	4,13	3,97	0,75
PP-1-JV/23		5,54	4,49	4,83	4,37	3,83	3,60	0,79
PP-1-JV/24		4,86	3,72	4,07	3,87	3,51	3,37	0,80
average		5,49	4,67	4,56	4,26	3,82	3,65	0,78
PP-1-JV/25	28	5,36	4,34	4,31	4,70	4,73	4,82	0,88
PP-1-JV/26		4,79	4,14	4,01	4,30	4,32	4,29	0,90
PP-1-JV/27		4,82	4,25	4,18	4,42	4,28	4,25	0,92
average		4,99	4,24	4,17	4,47	4,44	4,45	0,90
PP-1-JV/28	56	5,79	4,36	5,05	4,63	4,16	3,97	0,80
PP-1-JV/29		6,01	4,42	4,93	4,54	4,06	3,86	0,76
PP-1-JV/30		6,24	5,00	4,96	4,68	4,38	4,28	0,75
average		6,01	4,59	4,98	4,62	4,20	4,04	0,77
PP-1-JV/81	90	5,41	4,13	4,62	4,53	4,46	4,41	0,84
PP-1-JV/82		5,95	5,11	5,00	4,67	4,60	4,32	0,78
PP-1-JV/90		6,10	5,22	4,94	4,83	2,69	2,11	0,79
average		5,82	4,82	4,85	4,68	3,92	3,61	0,80

The ultimate splitting tensile strength f_{ct} increases unevenly with the age of PP-1-JV (third column in the table 5). After the first crack, and as the crack width increases, the equivalent strengths decrease moderately (Figure 10. Softening is moderate. For a given crack width, the equivalent strengths increase significantly from PP-1-JV age of 3 days to 8 days. Thereafter, the equivalent strengths increase relatively less and rather unevenly up to the age of 90 days.

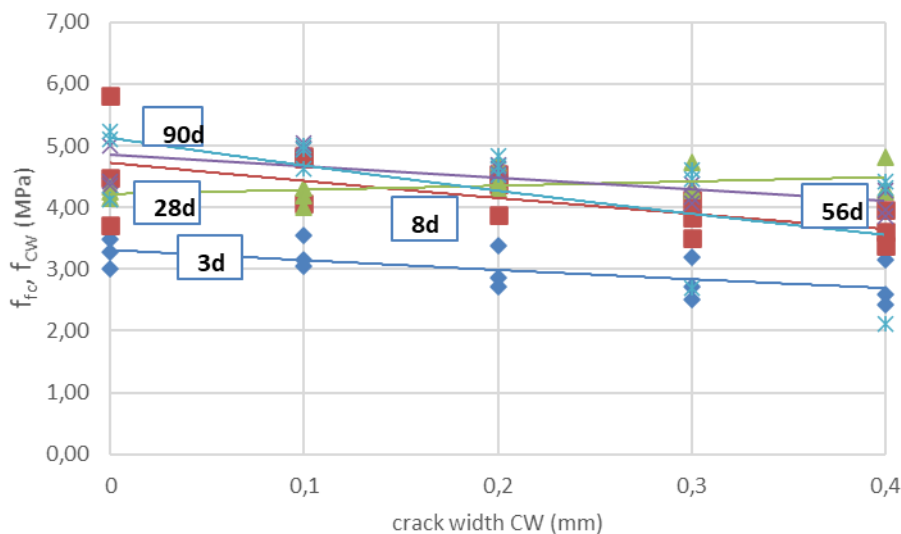

Figure 10. Equivalent splitting tensile strengths f_{CW} and splitting tensile strength at first crack f_{fc} of PP-1-JV as a function of crack width.

The RCP also varies in a similar way at different ages of PP-1-JV; average RCP values from age 3 to 90 days are around 0,80 (last column in Table 5). Regardless of the heterogeneity, all individual RCP results $\geq 0,75$, which means that PP-1-JV shows good resistance to crack propagation.

Table 6. Results of the wedge splitting test for PP-2.

designation of the test specimen	age of PP-2 (days)	ultimate splitting tensile strength - f_{ct} (MPa)	splitting tensile strength at first crack - f_{fc} (MPa)	equivalent splitting tensile strength up to the crack width (mm)				resistance to crack propagation RCP= $f_{0,2}/f_{ct}$
				0,1	0,2	0,3	0,4	
				$f_{0,1}$ (MPa)	$f_{0,2}$ (MPa)	$f_{0,3}$ (MPa)	$f_{0,4}$ (MPa)	
PP-2/19	4	3,42	2,41	2,58	2,20	1,86	1,59	0,64
PP-2/20		3,55	2,67	2,94	2,48	2,10	1,80	0,70
PP-2/21		3,20	2,18	2,78	2,19	1,92	1,70	0,68
average		3,39	2,42	2,77	2,29	1,96	1,70	0,68
PP-2/22	7	4,89	3,78	3,99	2,94	2,30	1,88	0,60
PP-2/23		3,81	2,63	3,07	2,25	1,75	1,44	0,59
PP-2/24		3,90	3,06	3,44	2,72	2,18	1,78	0,70
average		4,20	3,16	3,50	2,64	2,08	1,70	0,63
PP-2/25	27	5,65	5,11	4,61	3,54	2,75	2,25	0,63
PP-2/26		4,74	3,45	4,03	3,41	2,51	1,99	0,72
PP-2/27		4,96	4,82	4,18	3,18	2,34	1,87	0,64
average		5,12	4,46	4,27	3,38	2,53	2,04	0,66
PP-2/28	56	5,43	4,20	4,36	3,75	2,87	2,30	0,69
PP-2/29		6,04	4,40	4,81	3,98	2,97	2,39	0,66
PP-2/30		5,97	5,94	4,56	3,66	3,09	2,62	0,61
average		5,81	4,85	4,58	3,80	2,98	2,44	0,65
PP-2/88	90	6,26	5,61	4,81	3,55	2,57	1,89	0,57
PP-2/89		5,85	4,59	4,76	3,79	2,81	2,23	0,65
PP-2/90		6,45	4,92	5,35	4,39	3,29	2,59	0,68
average		6,19	5,04	4,97	3,91	2,89	2,24	0,63

The ultimate splitting tensile strength f_{ct} increases uniformly with the age of PP-2 (third column in the table 6). After the first crack, and as the crack width increases, the equivalent strengths decrease (Figure 11). Softening occurs. The equivalent strengths at a given crack width increase more rapidly from 4 to 27 days of age than from 27 to 90 days.

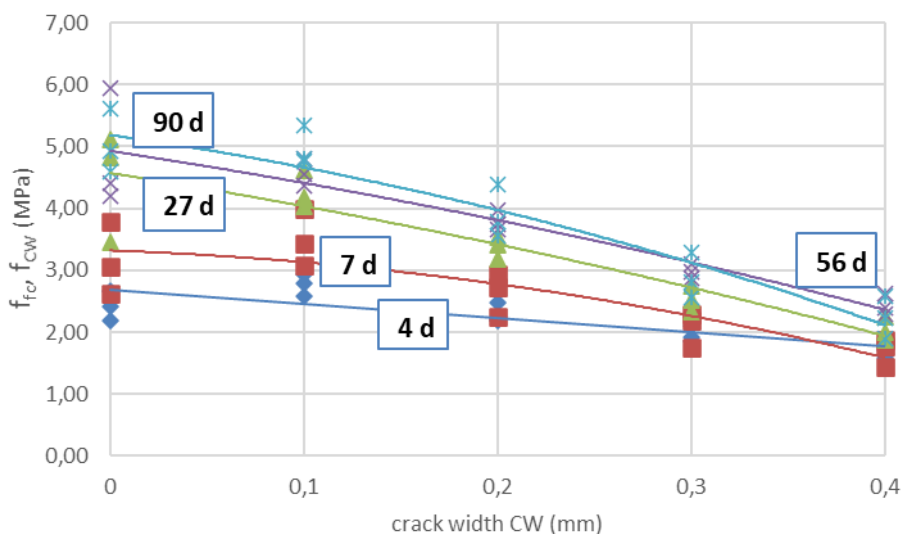

Figure 11. Equivalent splitting tensile strengths f_{CW} and splitting tensile strength at first crack f_{fc} of PP-2 as a function of crack width.

The RCP decreases moderately from age 27 to 90 days (last column in Table 6). All average values are > 0,60.

Table 7. Results of the wedge splitting test for PP-3.

designation of the test specimen	age of PP-3 (days)	ultimate splitting tensile strength - f_{ct} (MPa)	splitting tensile strength at first crack - f_{fc} (MPa)	equivalent splitting tensile strength up to the crack width (mm)				resistance to crack propagation RCP= $f_{0,2}/f_{ct}$
				0,1	0,2	0,3	0,4	
	$f_{0,1}$	$f_{0,2}$	$f_{0,3}$	$f_{0,4}$	-			
PP-3/19	3	3,20	2,78	2,73	2,03	1,64	1,37	0,63
PP-3/20		3,27	2,81	2,68	2,28	1,82	1,50	0,70
PP-3/21		3,21	2,03	2,90	2,50	2,19	1,95	0,78
average		3,23	2,54	2,77	2,27	1,88	1,61	0,70
PP-3/22	7	5,01	4,14	4,23	3,39	2,59	2,09	0,68
PP-3/23		4,61	3,46	3,60	2,94	2,35	1,95	0,64
PP-3/24		5,16	3,92	4,31	3,29	2,47	1,98	0,64
average		4,93	3,84	4,05	3,21	2,47	2,01	0,65
PP-3/25	28	5,41	4,45	4,49	4,03	3,40	2,72	0,74
PP-3/26		5,78	4,40	4,62	3,95	3,06	2,40	0,68
PP-3/27		5,83	3,68	4,47	4,33	3,89	3,01	0,74
average		5,67	4,18	4,53	4,10	3,45	2,71	0,72
PP-3/28	56	5,78	4,03	4,62	3,71	2,67	2,06	0,64
PP-3/29		6,03	5,37	4,77	3,81	2,82	2,23	0,63
PP-3/30		5,92	4,85	4,74	3,93	2,85	2,25	0,66
average		5,91	4,75	4,71	3,82	2,78	2,18	0,65
PP-3/88	90	5,80	4,07	4,67	3,83	2,85	2,20	0,66
PP-3/89		5,33	4,42	4,56	3,73	2,74	2,14	0,70
PP-3/90		5,72	4,49	4,41	3,69	2,83	2,25	0,65
average		5,62	4,33	4,55	3,75	2,81	2,20	0,67

The ultimate splitting tensile strength f_{ct} increases uniformly with the age of PP-3 up to 56 days of age (third column in the table 7). After the first crack, and as the crack width increases, the equivalent strengths decrease (Figure 12). Softening occurs. The equivalent strengths at a given crack width increase from 3 to 28 days of age and then decrease so that the values at 56 and 90 days are of the same magnitude, but less than those of 28-day old PP-3.

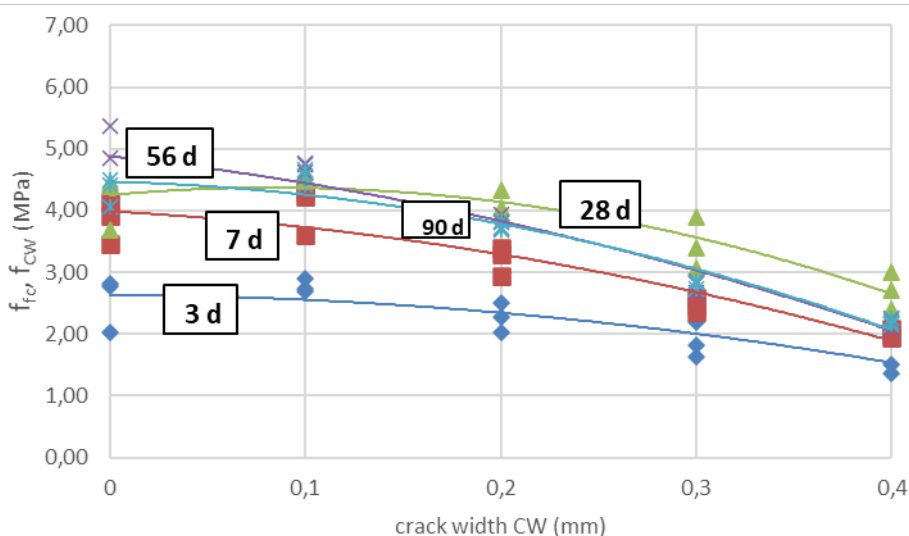

Figure 12. Equivalent splitting tensile strengths f_{CW} and splitting tensile strength at first crack f_{fc} of PP-3 as a function of crack width.

The resistance to crack propagation varies at different ages of PP-3; average RCP values from age 3 to 90 days are around 0,68 (last column in Table 7). All individual results are $> 0,60$.

In Figure 13, we give the results of the ultimate splitting tensile strength f_{ct} as a function of age for all HPC (PP-1, PP-1-JV, PP-2 and PP-3).

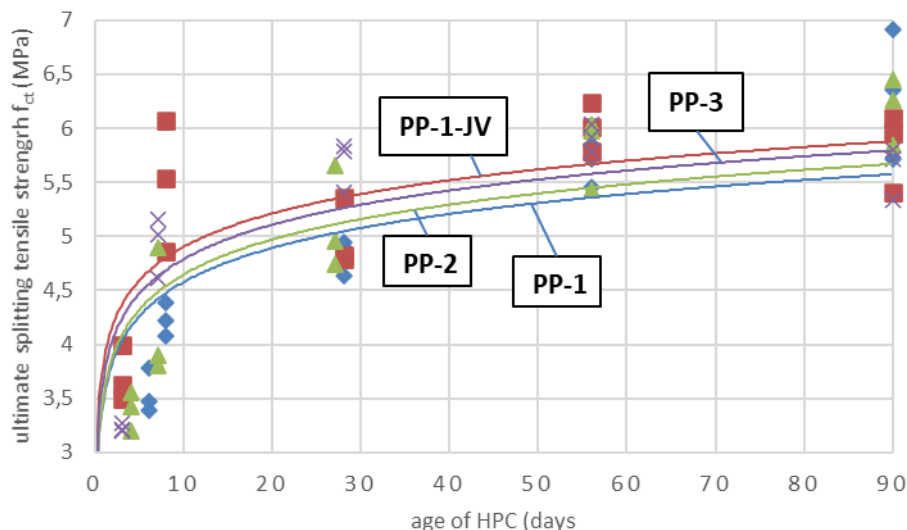

Figure 13. *Ultimate splitting tensile strength f_{ct} as a function of age for all HPC tested.*

There are relatively small differences between the ultimate splitting tensile strengths f_{ct} at all HPC ages. There is also a significant dispersion of results.

However, there is a larger difference between the RCPs of PP-1-JV, which deviates in magnitude from the RCPs of the other three HPCs (Figure 14).

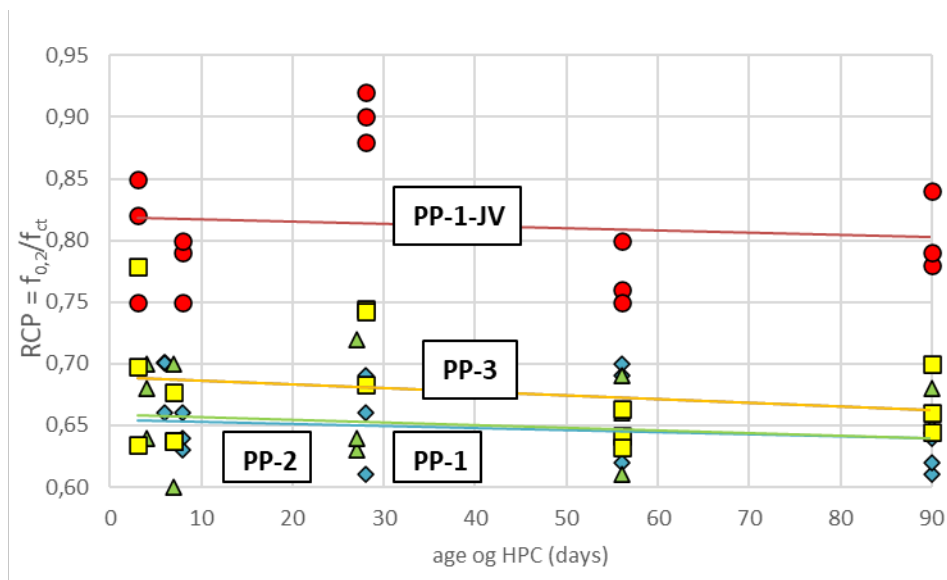

Figure 14. *Resistance to crack propagation as a function of age of HPC (PP-1, PP-1-JV, PP-2 and PP-3).*

This figure also shows that there is no correlation between RCP and HPC age; the RCP values of all HPCs do not change much on average with the age of the HPC, there is a slight trend of decreasing average RCP values with the age of the HPC.

The RCP results of all HPCs meet the required criterion of $RCP \geq 0,60$, which means that all HPCs show resistance to crack propagation. The RCP results obtained from PP-1-JV are relatively highest, around 0,80. All results for all ages PP-1-JV are greater than 0,75.

5. CONCLUSIONS

All the High-Performance Concretes (HPC) investigated in the project achieved very high durability in addition to high compressive strength due to their high-quality structure. However, to achieve a long service life of the structure, it is important that good resistance to crack propagation has been achieved in the HPC. The required $RCP \geq 0,60$ was achieved at all HPC ages. The added steel fibers further improve the resistance of the HPC to crack propagation. The $RCP = 0,75$, which is often required in practice for Fiber Reinforced Concrete structures, was easily exceeded.

LITERATURE

- [1] Reinhardt H.P. „Hochleistungsbeton (High Performance Concrete)“. Betonwerk + Fertigteil-Technik, Heft 1/1995 (Concrete Precasting Plant and Technology, Issue 1/1995). pp. 62 - 68.
- [2] Gjorv, O.E. “High-Strength Concrete. Advances in Concrete Technology”. CANMET. 1992. pp. 21 - 77.
- [3] Young F. Very high strength cement-based materials. Mat. Res.Soc. Vol. 42. Pittsburg, 1984. 317 p.
- [4] Hillemeier B. „Innovationen am Baustoffmarkt - Neue Baustoffe sichern das Bauen“. Zement und Beton. Wien. 1/96. pp. 1 - 8.
- [5] Richard P., Cheyrezy M. “Composition of Reactive Powder Concretes”. Cement and Concrete Research, Vol. 25, No. 7. 1995. pp. 1501 - 1511.
- [6] Cheyrezy M., Maret V., Frouin L. “Microstructural Analysis of RPC (Reactive Powder Concrete)”. Cement and Concrete Research, Vol. 25, No. 7. 1995. pp. 1491 - 1500.
- [7] Shah S.P. High Strength Concrete. University of Illinois at Chicago Circle. 1979. 226 p.
- [8] Russel H.G. “High Strength Concrete”. ACI SP-87. Detroit, 1985. pp. 1 - 278.
- [9] Malier Y. Les bétons à hautes performances. Presses de l'ENCP. Paris, 1990. 543 p.
- [10] Kuroiwa S., Mutsuoka Y., Hayakawa M. and Shindoh T. “Application of Super-workable Concrete to Construction of a 20-Story Building”. ACI, SP-140. 1993. pp. 147 - 161.
- [11] Stroeven, P. “Struktura agregata v betonu in njen vpliv na cementno pasto” (in Slovenian). Zbornik gradiv in referatov 13. slovenskega kolokvija o betonih: Agregati v betonu. IRMA. 2006. pp. 9 – 20.
- [12] Zajc, A. Uporaba mineralnih dodatkov v cementu in/ali betonu (in Slovenian). IRMA. 2015. 90 p.
- [13] Mindess S., Young J.F. and Darwin D. Concrete. Prentice Hall Inc., Englewood Cliffs. pages: 80 – 85, 176 – 181, 459 – 462, 477 – 478 and 542 – 543.
- [14] Diamond S., Mindess S., Lovell J. “On the Spacing between Aggregate Grains in Concrete and the Dimension of the Aureole of Transition”. RILEM Colloquium. Toulouse. 1982. pp. C42 - C46.
- [15] Rudert V., Strunge J., Wihler H.D. „Beton aus anderer Sicht - filigranes Mikrogefüge“. Betonwerk + Fertigteil-Technik 60. 1994. No. 9. pp. 86 - 93.
- [16] Šušteršič, J. „Doseganje posebnih lastnosti betona z dodatki“ (in Slovenian). Zbornik gradiv in referatov 14. slovenskega kolokvija o betonih: Posebne lastnosti betonov z dodatki. IRMA. 2007. pp. 9 - 19.
- [17] Tschegg, E.K. T-390328: „Prüfeinrichtung zur Ermittlung von bruchmechanischen Kennwerten sowie hierfür geeignete Prüfkörper“. 1986.
- [18] Linsbauer H., Tschegg, E.K. „Die Bestimmung der Bruchenergie an Würfelpföben“. Zement und Beton. 31 (1986) 1, pp. 38 - 40.
- [19] Tschegg, E.K. “Patent application No. 48/1990. Lasteinleitungsvorrichtung“. 1990.
- [20] Tschegg, E.K. “New Equipments for Fracture Tests on Concrete”. Materialprüfung 33. 11 – 12. München, 1991, pp. 338 - 342.
- [21] Šušteršič, J., Ercegovič, R., Polanec, D., Zajc, A. “Evaluation of behavior of the joint between two concrete layers during splitting”. V: SERNA, Pedro (ed.). Fibre reinforced concrete : improvements and innovations II : X RILEM-fib International Symposium on Fibre Reinforced Concrete (BEFIB) 2021. Cham: Springer, cop. 2022. RILEM bookseries, vol. 36. pp. 208-219.
- [22] Chen, L., Mindess, S., Morgan, D.R. ‘Toughness Evaluation of Steel Fibre reinforced Concrete’. Proceedings of 3rd Canadian Symposium on Cement and Concrete. Ottawa. 1993. pp. 16 – 29.
- [23] Morgan, D.R., Mindess S., Chen L., ‘Testing and Specifying Toughness for Fibre Reinforced Concrete and Shotcrete’. Fibre Reinforced Concrete. Modern Developments.

- Eds.: N. Banthia and S. Mindess. The University of British Columbia, Vancouver. 1995. pp. 29 – 50.
- [24] Šušteršič, J., Zajc, A., Leskovar, I., Dobnikar, V. "Improvement in the crack opening resistance of FRC with low content of short fibres". Ed.: Dhir, Ravindra K. Role of concrete in sustainable development : proceedings of the International Symposium dedicated to professor Surendra Shah, Northwestern University, USA held on 3-4 September 2003 at the University of Dundee, Scotland, UK. London: Thomas Telford. pp. 167-174.
- [25] Šušteršič, J., Ercegovič, R, et al. Poročilo projekta Študija proizvodnje, vgradljivosti in karakteristik končnih betonskih mešanic za izvedbo sekundarne armiranobetonske obloge silosa odlagališča NSRAO (in Slovenian). IRMA. 2020. 646 p.

05

Research paper I Оригинални научни рад
DOI 10.7251/STP2215045C
ISSN 2566-4484



Anđelko Cumbo, University of Banja Luka, andjelko.cumbo@aggf.unibl.org
Gordana Broćeta, University of Banja Luka, gordana.broceta@aggf.unibl.org
Marina Latinović Krndija, University of Banja Luka, marina.latinovic@aggf.unibl.org
Mladen Slijepčević, University of Banja Luka, mladen.slijepcevic@aggf.unibl.org
Žarko Lazić, University of Banja Luka, zarko.lazic@aggf.unibl.org

THE INFLUENCE OF CONCRETE VISCOUS DEFORMATIONS DURING BEHAVIOR CALCULATION OF CABLE-STAYED BRIDGES

Abstract

On the calculation example of a cable-stayed bridge with oblique cables, it was pointed out the shrinkage and creep of concrete significantly affects the distribution of stresses and deflections of the span beam over time. The segmental type of bridge construction is considered, which implies the successive introduction of concrete rheology, for cases of controlled and free beam deflections during construction, i.e. with or without cable tightening on previously performed segments. The phenomenon of reduced sensitivity of the span beam to the effects of concrete rheology is pointed out, in case of controlled deflections by cable tightening, while without cable tightening the deflections increase over time and can negatively affect the usability of the structure. The analyses were performed using an appropriate algorithm (developed by the author) which introduced composite layered finite elements with viscous properties into the calculation.

Keywords: cable-stayed bridges, concrete creep and shrinkage, finite elements.

УТИЦАЈ ВИСКОЗНИХ ДЕФОРМАЦИЈА БЕТОНА ПРИ ПРОРАЧУНУ ПОНАШАЊА МОСТОВА СА КОСИМ ЗАТЕГАМА

Сажетак

На примјеру прорачуна овјешеног моста (са косим кабловима) указано је да скупљање и течење бетона значајно утиче на расподјелу напрезања и угиба распонске греде током времена. Разматран је сегментни тип градње моста, што подразумева сукцесивно увођење реологије бетона, за случајеве контролисаних и слободних угиба греде током градње, односно са или без дотезања каблова на претходно изведеним сегментима. Указано је на феномен смањене осјетљивости распонске греде на ефекте реологије бетона ако се контролишу угиби дотезањем каблова, док се без дотезања каблова угиби током времена повећавају и могу негативно утицати на употребљивост конструкције. Анализе су урађене коришћењем одговарајућег алгорита (развијеног од стране аутора) којим су у прорачун уведени спрегнути слојевити коначни елементи са вискозним својствима.

Кључне ријечи: овјешени мостови, течење и скупљање бетона, коначни елементи.

1. INTRODUCTORY REMARKS

It is known that the shrinkage and creep of concrete in time can have a significant impact on the changes in stress and strain in composite structures [1] [2] [3] [4]. These deformations can be two to three or even several times larger than elastic deformations, which is why it is very important to perform adequate analysis when designing structures, taking into account the degrees of indeterminacy of the structure and different time intervals of inclusion of individual elements/layers in stress activity (segmental construction).

To solve such and similar problems, a computational algorithm with layered finite elements was developed (by the author) within the broader work on the analysis of the influence of rheological properties of concrete and prestressed reinforcement in complex (statically indeterminate) composite structures. To gain the stiffness matrix of finite element (FE), the layer method in cross-section was applied, and influences due to viscous properties of the material were introduced via fictitious load [1] [2]. By applying an incremental form of stress-strain relation for individual materials it is enabled to generalize the procedure for discontinuous and continuous changes by introducing the required number of fictitious ($\Delta t_k=0$) and finite time intervals ($\Delta t_k \neq 0$). This reduces the overall calculation procedure to solving algebraic equations (in matrix form), which enables the calculation automatization, thus an appropriate software algorithm is formed, suitable for application in practice when it comes to controlling the serviceability limit states.

In general, the calculation model includes rigidly composed layered elements, and applies the *Bernoulli* hypothesis of flat cross-sections and the linear theory of concrete creep. The expressions introduce the following labels for common materials: a-structural steel, c-concrete, s-reinforcement, and p-prestressing cables. In the general case, for the deformation of the observed fiber in the composed cross-section in the current time interval Δt_k , the equality is given [1]:

$$\Delta \varepsilon_k = \Delta \varepsilon_{r,k} + \Delta \kappa_k \cdot y \quad (1)$$

where:

$\Delta \varepsilon_k$ - deformation increment of the observed fiber in the cross-section in k -th time interval,

$\Delta \varepsilon_{r,k}$ - deformation increment at the level of the reference axis of the cross-section r ($y=0$),

$\Delta \kappa_k$ - cross-sectional curvature,

y - distance of the observed fiber from the reference axis r .

According to the linear distribution of deformations, the stresses along the height of the composed cross-section are also distributed linearly. However, unlike deformations, the stress increment for each layer/material of the composite cross-section is defined with a separate pair of parameters $\Delta \alpha_{r,k}$ and $\Delta \beta_k$, following the constitutive stress-strain relations for individual materials, whereby abrupt changes occur at the contacts of different materials. If the expressions are written in vector form, equations for individual materials in the current time interval Δt_k have the following forms:

$$\begin{Bmatrix} \Delta \alpha_r \\ \Delta \beta \end{Bmatrix}_{m,k} = E_m \cdot \begin{Bmatrix} \Delta \varepsilon_r \\ \Delta \kappa \end{Bmatrix}_{m,k} ; m=a,s \quad (2)$$

$$\begin{Bmatrix} \Delta \alpha_r \\ \Delta \beta \end{Bmatrix}_{c,k} = E_{c(k,k-1)} \cdot \left(\begin{Bmatrix} \Delta \varepsilon_r \\ \Delta \kappa \end{Bmatrix} - \begin{Bmatrix} \Delta \varepsilon_r^* \\ \Delta \kappa^* \end{Bmatrix} \right)_{c,k} \quad (3)$$

$$\begin{Bmatrix} \Delta \alpha_r \\ \Delta \beta \end{Bmatrix}_{p,k} = E_p \cdot \begin{Bmatrix} \Delta \varepsilon_r \\ \Delta \kappa \end{Bmatrix}_{p,k} + \begin{Bmatrix} \Delta \bar{\sigma}_{pr} \\ 0 \end{Bmatrix}_{p,k} \quad (4)$$

The vector of the free deformations increment in concrete, when the shrinkage deformation is equal for all points along the height of the cross-section, has the form:

$$\begin{Bmatrix} \Delta \varepsilon_r^* \\ \Delta \kappa^* \end{Bmatrix}_{c,k} = \sum_{i=1}^{k-1} \frac{1}{E_{c(k,i-1)}} \cdot \begin{Bmatrix} \Delta \alpha_r \\ \Delta \beta \end{Bmatrix}_{c,i} + \begin{Bmatrix} \Delta \varepsilon_n \\ 0 \end{Bmatrix}_{c,k} \quad (5)$$

The basic equation of the composed FE [1] in the local coordinate system for the current time interval Δt_k is:

$$[K]_k \cdot \{\Delta q_r\}_k = \{\Delta Q\}_k - \{\Delta Q^*\}_{c,k} - \{\Delta Q^*\}_{p,k} \quad (6)$$

where:

$[K]_k$ - stiffness matrix of the composed FE,

$\{\Delta q_r\}_k$ - vector of nodal displacements from the reference axis r ,

$\{\Delta Q\}_k$ - vector of external nodal forces,

$\{\Delta Q^*\}_{c,k}$ - vector of fictitious nodal forces due to creep and shrinkage of concrete,

$\{\Delta Q^*\}_{p,k}$ - vector of fictitious nodal forces due to relaxation of prestressed reinforcement.

Forming a system of equations for a total FE mesh of structure, requires the prior formation of the basic equations for each FE. Thereby, it is necessary to transform the stiffness matrix and force vectors for each FE from the local to the global coordinate system. The equilibrium equation of the system (matrix shape) is obtained when the stiffness matrices and force vectors from expression (6) for each FE are superimposed in accordance with the connection criterion for system nodes. By setting the stiffness matrix coefficients and the FE force vectors at the appropriate positions, a generalized equilibrium equation is formed for the whole composite system, for the current time interval Δt_k :

$$[\tilde{K}]_k \cdot \{\Delta \tilde{q}_r\}_k = \{\Delta \tilde{Q}\}_k - \{\Delta \tilde{Q}^*\}_{c,k} - \{\Delta \tilde{Q}^*\}_{p,k} \quad (7)$$

The system of algebraic equations (7) includes the elastic and rheological properties of the applied materials by layers, for all individual FEs in the construction system. Visco-elastic changes are included in finite time intervals ($\Delta t_k \neq 0$), while elastic (discontinuous) changes are included in fictitious time intervals ($\Delta t_k = 0$). The connection between the displacement vector and the force vector in the system nodes is established via the stiffness matrix. By solving the system of algebraic equations (7) the vector of nodal displacements of the system for the current time interval Δt_k is determined with the previous introduction of boundary conditions. After the transformation of the displacement vector into local coordinate systems, the component deformations for each FE are determined [1]:

$$\begin{Bmatrix} \Delta \varepsilon_r \\ \Delta \kappa \end{Bmatrix}_k = [B_r] \cdot \{\Delta q_r\}_k + \begin{Bmatrix} \Delta \varepsilon_N \\ -\Delta \kappa_M \end{Bmatrix}_k \quad (8)$$

where:

$\Delta \varepsilon_{N,k}$ - part of deformation resulting from averaging of fictitious normal forces $\Delta N_{N,k}$ of the observed element,

$\Delta \kappa_{M,k}$ - the part of the curve originating from the external distributed load in the middle-span of the element introduced through the equivalent nodal forces, where the moments $\Delta M_{M,k}$ appear, which do not exist,

$[B_r]$ - interpolation matrix (shape function) for the reference axis in the nodes of the element.

The parameters of total stresses and strains for the discrete moment are determined by the superposition of the previous state and the change of state in the current time interval (step-by-step procedure: $t_k = t_{k-1} + \Delta t_k$):

$$\begin{Bmatrix} \alpha_r \\ \beta \end{Bmatrix}_k = \begin{Bmatrix} \alpha_r \\ \beta \end{Bmatrix}_{k-1} + \begin{Bmatrix} \Delta \alpha_r \\ \Delta \beta \end{Bmatrix}_k ; \quad \begin{Bmatrix} \varepsilon_r \\ \kappa \end{Bmatrix}_k = \begin{Bmatrix} \varepsilon_r \\ \kappa \end{Bmatrix}_{k-1} + \begin{Bmatrix} \Delta \varepsilon_r \\ \Delta \kappa \end{Bmatrix}_k \quad (9)$$

Stresses in the cross-section of individual layers change linearly by the height, while at the contacts jumps in diagram appear as a result of different material properties. More about that in [2][3][4][5][6][7].

2. CABLE-STAYED BRIDGE CALCULATION EXAMPLE

An example of calculation using the formed algorithm is given for a cable-stayed bridge with steel cables and a concrete girder, with a span 120+120 m. The bridge structure is inhomogeneous and statically indeterminate, with multiples degrees of indeterminacy, where layered viscoelastic elements have been used for the concrete main beam, while elements with elastic properties have been used for the concrete pylon and steel cables. The pylon was considered to have great rigidity and to be rigidly clamped in the ground. The method of cantilever construction was applied, where segments of concrete beams (slabs) are poured on-site and hung with a pair of oblique steel cables on the pylon. This is in accordance with the usual procedures for the construction of suspended structures of medium and large span bridges.

A constant change of the static system during construction is present, and also the changes of concrete in time caused by the shrinkage and creep. This is reflected primarily in the changes in forces in the cables, and in the deflections and stress redistribution in the concrete beam. Thus, it is necessary to estimate the changes in stress and strain, as well as the changes in deflection from the

relevant load, as realistically as possible, to prevent negative effects on the load-bearing capacity and serviceability of the bridge.

The analysis of the bridge structure with the introduced rheology of concrete was conducted for a period of 10.000 days (27,4 years), for two different stiffness levels of oblique stay cables. In the first case, the actual stiffness of the cables was taken (no forced deflection/displacement retention, ie $s = 0\%$), which corresponds to the case without the subsequent tightening of previously installed cables when adding each new beam (slab) segment. In this case, the vertical movement (deflection) of the main beam occurs under the actual stiffness of the concrete beam and steel cables. In the second case, the high stiffness of the cables is used in the calculation ($s = 100\%$), ie the horizontality of the bridge beam is maintained by preventing vertical displacements (eg constant tensioning/loosening of cables). In this case, a more realistic assessment of the impact of cable tension on the effects of reduction of concrete deformations in time is possible.

A similar example is analyzed in the paper *Sassone and Casalegno* [5] in which the significant contribution of concrete rheology to the changes of stresses and deformations in the bridge structure over time is pointed out, and the calculation algorithm is implemented in a software environment *Matlab 7* together with a commercial software *TNO Diana 9.4*.

For the example analyzed herein, a schematic model of a suspension bridge with concrete beam, pylon, and steel cables is given in Figure 1. Segmental construction of cantilever beams (slabs) is performed symmetrically starting from the pylon, left and right, by casting on site. At the end of each performed segment, a pair of steel cables are attached, which are used to hang the segments on the pylon. The time of completion of the two symmetric segments is assumed to be 28 days. The length of each segment of the beam (slab) is 24 m, and the height of the pylon at the place of hanging the cables is 50 m. Five segments of beams on each side of the pylon, suspended with five pairs of steel cables were considered.

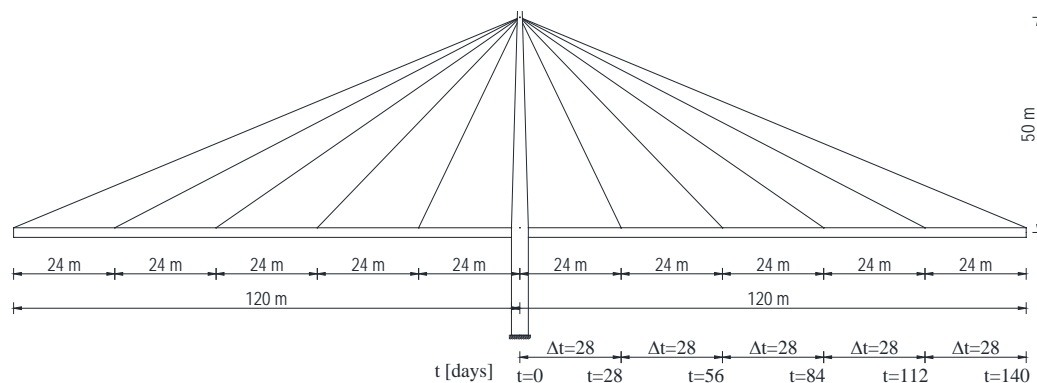

Figure 1. The scheme of the suspension bridge with oblique cables

The material characteristics, the predicted loads, and the geometry of the elements are given in Figures 2. Figure 3 shows approximate static systems and loads at characteristic intervals (for easier understanding), while in the calculation model all elements and loads are precisely entered, and then the activation of loads and stiffness by segments is regulated in accordance with the real conditions of the applied construction technology.

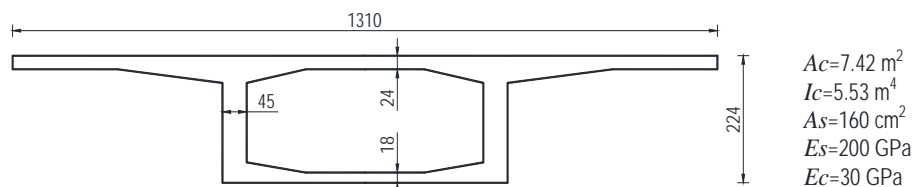

Figure 2. The cross-section of the main beam of the bridge

The rheological characteristics of concrete of the main beam were taken following EC2 recommendations, for all relative time relations between discrete moments, and the calculation was carried out by successive application of the AAEM (Age Adjusted Effective Modulus) method. The deformations of the rigid concrete pylon were neglected in the calculation, and also the effect of relaxation within high-grade steel cables over time. A homogeneous concrete beam (slab) with the constant creep and shrinkage properties over beam height was considered. However, as stated, the different ages of concrete for individual beam segments during construction and the stress activations were not neglected, which is very important for this type of bridge construction.

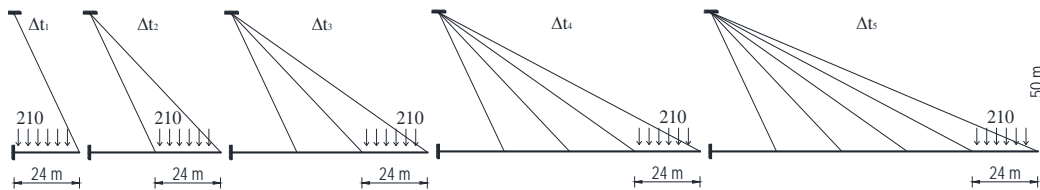

Figure 3. Static systems and loads for considered time intervals

The discretization of the total time was carried out in accordance with Figure 4. The total time is divided into 12 intervals following the adopted technology of construction of the main structure of the bridge. The calculation does not neglect different ages of concrete at the time of loading, ie the construction of the next beam (slab) segment includes the load from that segment, and it considers the contribution of concrete rheology in previously constructed concrete segments according to the time scale.

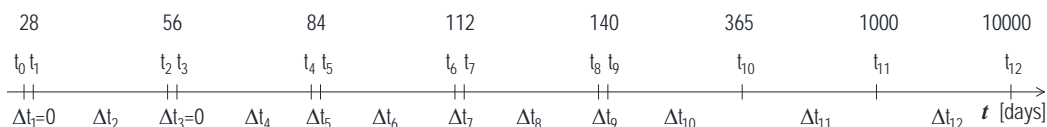

Figure 4. Time discretization in accordance with the planned construction of the bridge

2.1. ANALYSIS OF CALCULATION RESULTS

After the calculations, the characteristic stress diagrams in steel cables are given (Figures 5 and 6), as well as the diagrams of deflections (Figures 7 and 8) and bending moments (Figures 9 and 10) of the main concrete beam for the cases with and without cable tensioning.

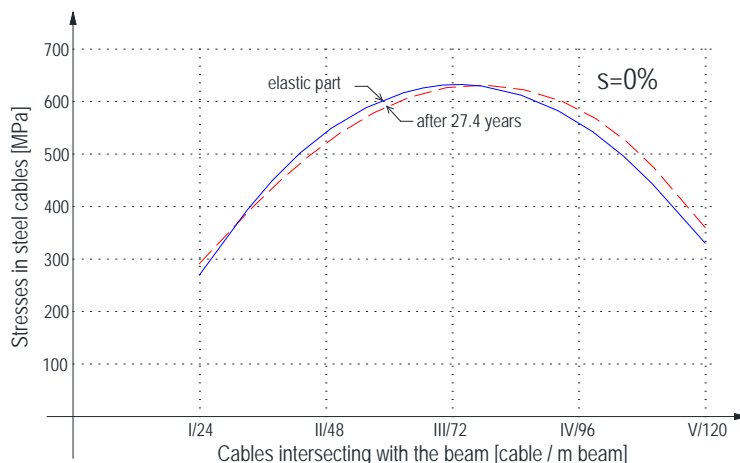

Figure 5. Stresses in steel cables

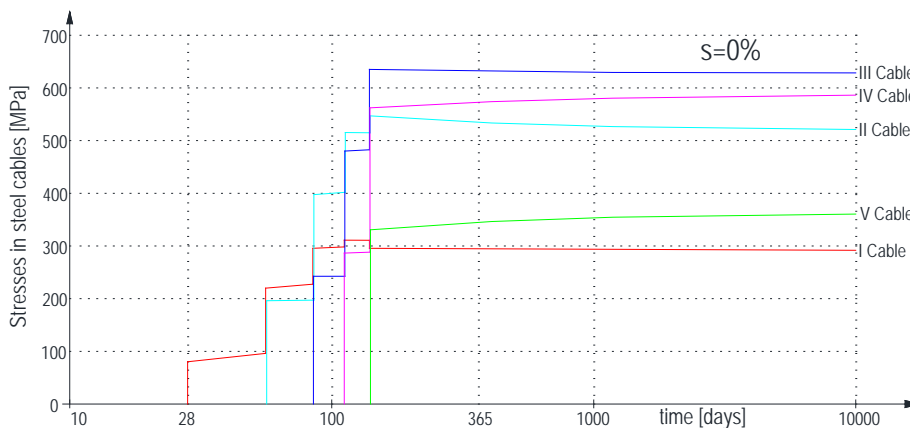

Figure 6. Stress change in steel cables over time

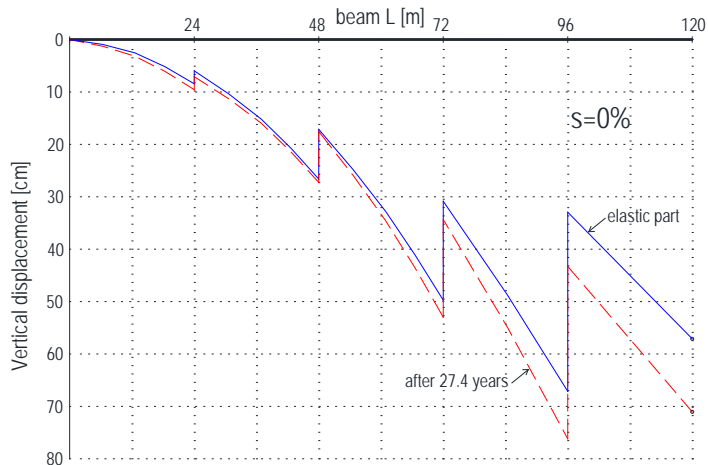

Figure 7. Vertical displacement of concrete beam segments

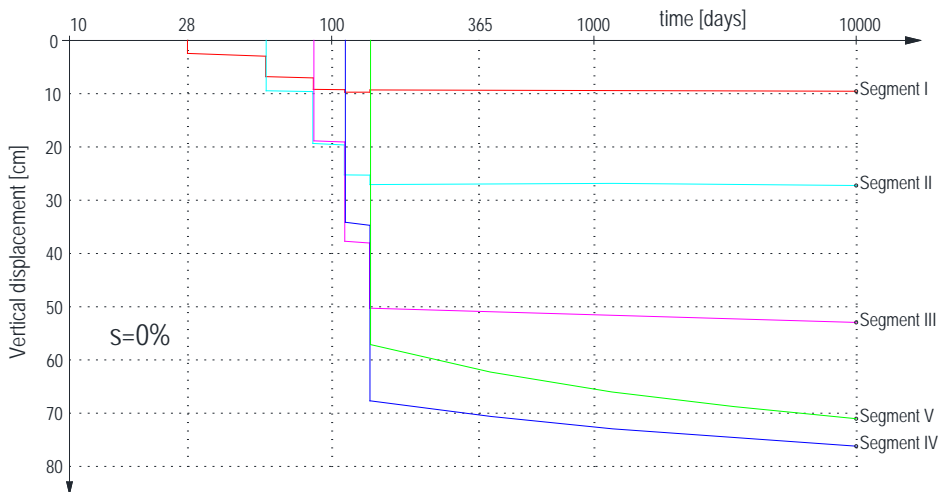

Figure 8. Vertical displacement of concrete beam segments in time

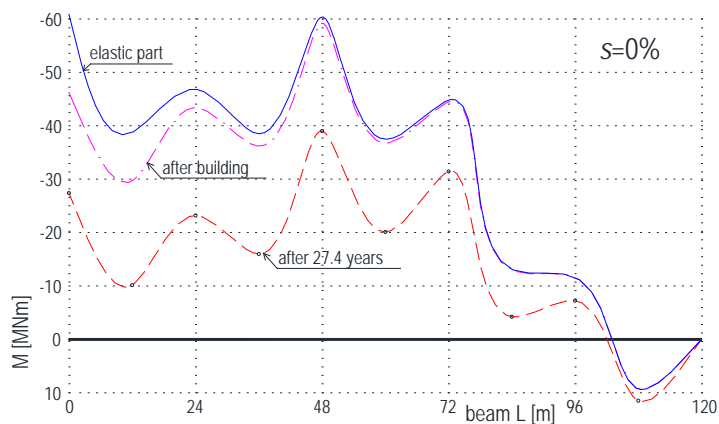

Figure 9. Bending moments along the beam (for $s=0\%$)

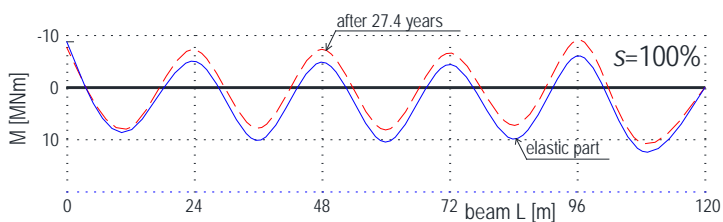

Figure 10. Bending moments along the beam (for $s=100\%$)

Although some of the assumptions introduced in this example do not apply for all common cases of similar bridges in practice, significant impacts and their change in characteristic moments can be seen through successive design analyses of the bridge structure, with the emphasis on the main concrete beam, thus, through these analyses, useful conclusions can be drawn, when it comes to the contribution of the viscous properties of concrete in cable-stayed bridge structures [5]:

- Tightening of cables during segmental construction of the bridge, to continuously maintain the horizontality of the span beam, ie the projected elevation of this beam, has a beneficial effect, because it maintains the desired level of the main beam, and thus reduces the sensitivity of concrete to shrinkage and creep. This condition is achieved in the case of fixed suspension points (cable stiffness $s=100\%$) in the calculation, which means that the diagram of bending moments along the main beam is fairly uniform and has a shape typical for a continuous beam (Figure 10). Due to the rheology of the concrete, this diagram moves slightly upwards over time, thus the beam in the middle area of the span is somewhat unloaded, and in the support zones it is additionally stressed by the approximately same absolute value of the moment.
- In the case of actual numerical stiffness of cables ($s=0\%$), where, in fact, during the construction of each new segment of the main beam, the cables of previously constructed segments are not tightened, that is, beam deflections depend on the real stiffness of cables and on the load in each calculation interval (they grow), the creep and shrinkage of the concrete cause significant changes in the stress of the main structure (beam) over time. In this case, the bending moments of the main beam decrease over time, and the deflections increase. However, it should be noted that the initial bending moments are quite unfavorable for this type of bridge construction. Namely, these bending moments, unlike in the previously analyzed state ($s = 100\%$), have a high intensity and are negative along the entire length of the beam, except in the last segment where the positive values in absolute are significantly lower than the negative moments.
- In general, the rheology of concrete causes a more favorable distribution of the bending moments in the main beam and reduces the amplitudes of the moments over time for this type of structure and the construction technology. This relative change (reduction) of moments, compared to the initial values, is much more pronounced in the case when the cables are not tightened during construction ($s=0\%$), while in the case of tightening the cables ($s=100\%$) the initial moments are much smaller, and they change very little over time, so the contribution of concrete rheology, in this case, can be neglected.

3. CONCLUDING REMARKS

In general, based on the analyzed example and remarks, it can be concluded that the presented calculation model, within the assumed assumptions, can be used for analysis of different cases in engineering practice, when it comes to controlling serviceability limits with the consideration of time deformations of concrete through appropriate layered elements of structure. The generalized calculation model also includes statically indeterminate, where the impacts change in the cross-sections without changing the external load, which is a great contribution of this calculation model. It is also important to point out that more complex cases can be analyzed in practice, such as e.g. subsequent interventions due to the strengthening and rehabilitation of existing structural systems, and various construction methods (cantilever systems, continuation of prefabricated elements with additional concrete or prestressing cables, etc).

The conclusion is that in the calculation of most structures it is necessary to include viscoelastic properties of materials, primarily shrinkage and creep of concrete, because stresses and deformations can change significantly over time [6]. Pressed concrete layers are in principle unloaded, and additional impacts are taken over by steel elements (reinforcement). It is also very important that these impacts are observed in the real conditions, during the applied construction technology through all characteristic time intervals. Considering the analysis of the serviceability limit states, any redistribution of impacts and changes (increment) in deflection should be reduced to an acceptable measure, thus possible negative effects in the building operation should be prevented.

The example of the suspension bridge analyzed herein indicates the need to tighten the cables of the previously built concrete segment of the main beam when adding each new segment. This achieves uniformity of the stresses and deflections along the entire length of the main beam, and the impact of concrete rheology is reduced to a minimum. Otherwise, if the cables are not tightened, the stresses and deflections along the beam are notably uneven, with the rheology of concrete in these conditions reducing the ultimate stresses and increasing deflections.

LITERATURE

- [1] A. Cumbo and R. Folić, "Layered Finite Elements in the Analysis of Composite Structures Exposed to Long-Term Effect," *Građevinar*, vol. 69, no. 11, pp. 991-1005, 2017.
- [2] R. Folić and A. Cumbo, "Theoretic Bases for Analysis of Viscous Deformations in Composite Beams Using the Finite Elements Method," *Bulletins for Applied & Computing Mathematics*, Vols. BAM-1770, pp. 17-28, 2000.
- [3] M. A. Chiorino and D. J. Carreira, "Factors Affecting Creep and Shrinkage of Hardened Concrete and Guide for Modelling," *ICJ The Indian Concrete Journal*, vol. 86, no. 12, pp. 11-24, 2012.
- [4] R. Folić, V. Radonjanin and M. Malešev, "Design and Analysis of Steel-Concrete Composite Structure," in *Introductory - Invited paper on 6th Greek National Conference on Metal Structures*, Athens, 2008. pp. 72 – 87.
- [5] M. Sassone and C. Casalegno, "Evaluation of the Structural Response to the Time-Dependent Behaviour of Concrete: Part 2 - A General Computational Approach," *ICJ The Indian Concrete Journal*, vol. 86, no. 12, pp. 39-51, 2012..
- [6] R. C. Lagos, M. C. Kupfer, S. T. Sanhueza and F. V. Cordero, "Costanera Center - Shortenings Due to Elastic Deformation, Creep and Shrinkage of Concrete in a 300-m Tall Building," *ICL The Indian Concrete Journal*, vol. 86, no. 12, pp. 53-60, 2012.

06

Research paper | Оригинални научни рад
DOI 10.7251/STP2215053M
ISSN 2566-4484



Marija Mirković, JP EPS, ogranak Kolubara, marija.mirkovic@rbkolubara.rs
Aleksandar Radević, University of Belgrade, aradevic@grf.bg.ac.rs
Dimitrije Zakić, University of Belgrade, dimmy@imk.grf.bg.ac.rs
Aleksandar Savić, University of Belgrade, savic.alexandar@gmail.com
Marina Askrabić, University of Belgrade, amarina@grf.bg.ac.rs
Dragica Jevtić, University of Belgrade, dragica@imk.grf.bg.ac.rs

THE EFFECT OF THERMAL TREATMENT ON MECHANICAL AND DEFORMATION PROPERTIES OF STEEL REINFORCEMENT

Abstract

Presented research was intentioned to clarify the effects of thermal treatment (ageing) of reinforcing steel products on their mechanical and deformation properties. In order to determine the effect of temperature, samples were exposed to room temperature (reference samples) and a temperature of 100 °C in duration of 30, 60 and 120 minutes, respectively. Tests were conducted on bars, coils and welded fabrics. After the thermal treatment, samples were exposed to tensile testing. The duration of the ageing treatment did not significantly affect measured properties of the tested products. Still, longer ageing process increased the yield stress of samples taken from coils by 7%, while the welded fabrics reached optimum values of yield stress and elongation after ageing of 60 minutes.

Keywords: steel reinforcement, σ - ϵ diagram, yield stress, maximum stress, elongation.

UTICAJ POSTUPKA STARENJA NA MEHANIČKO-DEFORMACIONA SVOJSTVA ČELIKA ZA ARMIRANJE BETONA

Сажетак

Истраживање је имало за циљ да се испита утицај поступка старења челика за армирање бетона на његова механичка и деформациона својства. Да би се одредио ефекат температуре на предметна својства арматурног челика, узорци су излагани собној температури (контролни узорци) или температури од 100°C у трајању од 30, 60 и 120 мин, респективно. Испитивања су обављена на шипкама, котуровима арматурним мрежама. Узорци су излагани аксијалном затезању. Трајање третмана старења није значајно утицало на карактеристике испитиваних производа. Ипак, дуже трајање старења котурова доводи до повећања напона течења од 7%, док су код арматурних мрежа оптималне вредности напона течења и издужења измерене након старења од 60 мин.

Кључне ријечи: арматурни челик, σ - ϵ дијаграм, напон течења, максимални напон, издужење.

1. INTRODUCTION

Among all steel products used in construction, the steel reinforcement represents a very important group of products, since it is one of the mostly used materials in the world (as a part of reinforced concrete).

Important properties of reinforcing steel, such as tensile strength, yield stress, hardness, ductility and plasticity can be improved with changes in the chemical composition of steel, through alloying, changing of the size of the metal grains, etc., but also through different treatments in the secondary production phase (thermal treatments, rolling, drawing, extruding, and so on) [1].

Thermal treatments are defined as processes that include heating of products up to the critical temperature, holding this temperature for a defined period of time, and then cooling the product in a prescribed way and velocity. One of the mostly applied ways of improvement of properties is thermal treatment of steel, usually referred to as ageing. In simple terms, cold deformation controls the number of dislocations, as well as the size and the number of polycrystal grains in the metal, while thermal treatment and alloying influence the size and the shape of the grains, number of spot defects, as well as the fineness and distribution of different phases of metal alloys. These methods for steel improvement are mutually intermixed and can give similar effects.

After the production in the steel mill, the steel is reshaped through rolling and/or drawing into wires, coils and bars (smooth or ribbed) with different diameters. Bars or coils prepared in this way, may be used as final products, that are shipped directly to the construction site, or as half products that are further used in production of welded fabrics (steel meshes) and lattice girders. Standard SRPS EN 10080 recognizes the following products for concrete reinforcement [2]:

- Bars, coils (rod, wire) and de-coiled products,
- Sheets of factory-made machine-welded fabric, and
- Lattice girders.

Standard SRPS EN 10080 (*Steel for the reinforcement of concrete - Weldable reinforcing steel – General*) defines the testing methods for different reinforcement products, as shown in Table 1. Most of the tests should be performed on the samples exposed to ageing. Ageing is defined as heating of the specimens to the temperature of 100 °C, holding this temperature ± 10 °C during one hour ± 15 minutes and then cooling in still air to room temperature, with no air flow.

Having in mind that the European norm EN 10080 was accepted in Serbia as active standard in 2008 and that for the reinforced steel used on domestic construction sites there are no published data on the effect of ageing on steel properties, large experimental testing regarding this topic has been conducted.

Table 1. Conditions of testing the mechanical properties [2]

Manufacturing and delivery conditions of the product	Conditions of testing (test pieces)
Produced in straight lengths by hot rolling	As delivered ^{a)} or aged ^{b)}
Produced in straight lengths by cold working	Aged ^{b)}
Produced as coil and delivered de-coiled	Aged ^{b)}
Produced and delivered as coil	Straightened and aged ^{b)}
Welded fabric	Aged ^{a), b), b)}
Lattice girders	Aged ^{a), b), b)}
^{a)} Aged, in case of dispute. ^{b)} Aged means: Heating of the test piece to 100 °C, maintaining at this temperature ± 10 °C for a period of 1 h ± 15 min and then cooling in still air to room temperature. The method of heating is left to the discretion of the manufacturer. ^{c)} Or as delivered when the constituents are produced in straight lengths by hot rolling.	

2. LITERATURE REVIEW

Elghazouli et al. [3] have tested properties of reinforcing bars with 6 mm, 8 mm and 10 mm in diameter, exposed to the tensile stresses in different temperatures and stress conditions, with special attention paid to the temperature influence on ductility of steel. These tests were performed in order to analyse the behaviour of reinforced concrete slabs exposed to fire.

The types of the tested reinforcing bars are shown in Table 2.

Table 2. Types of the tested reinforcing bars [3]

Applied production procedure	Sample mark	Description
Hot rolling	P10	Smooth bar \varnothing 10 mm
	D10	Ribbed bar \varnothing 10 mm
	P6	Smooth bar \varnothing 6 mm
Cold rolling	D6	Ribbed bar \varnothing 6 mm
	D8	Ribbed bar \varnothing 8 mm

The following test conditions were applied:

- Tensile test at room temperature,
- Tensile test at the constant (increased) temperature and raising stress,
- Tensile test at the raising temperature and constant stress,
- Testing of retained properties (laying of samples on constant temperature in duration of at least 30 min, slow cooling to the room temperature, and then tested with increasing stress).

Stress-strain diagrams of all samples tested at room temperature are shown in Figure 1. Bars acquired through hot rolling production process show clearly detectable yield stress, which is not the case for the cold rolled bars.

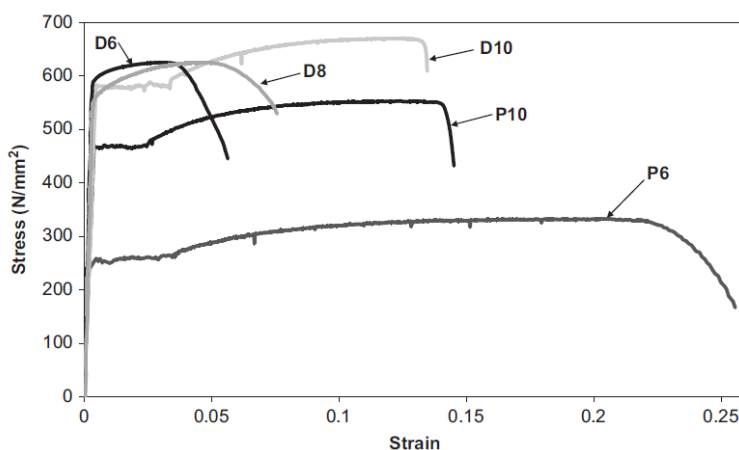

Figure 1. Results of tensile test in room temperature [3]

In the case when samples were aged (heated up to the determined temperature with holding the temperature for duration of 30 min, and then slowly cooled down to the room temperature), and then tested using tensile test, the stress-strain diagrams presented in Figures 2 and 3 were recorded.

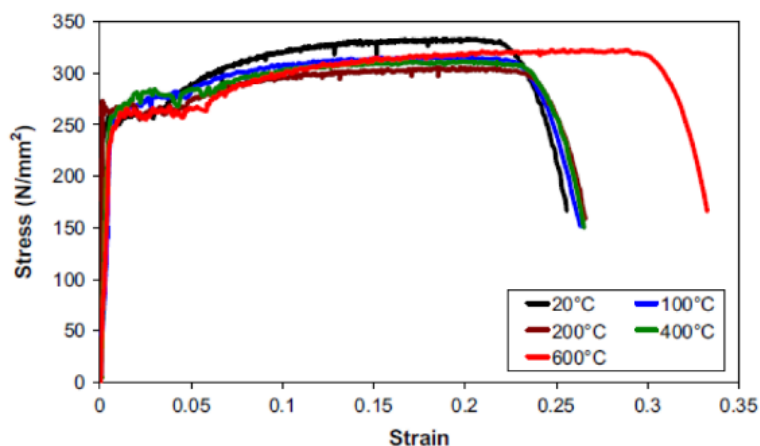

Figure 2. Stress-strain diagram for sample P6 exposed to ageing on different temperatures [3]

As it can be noticed in Figure 2, hot rolled bar P6 had clearly detectable yield stresses. Apart from the case when samples were exposed to the temperature of 600 °C, the increase in temperature led to the reduction of tensile strength, while yield stresses and elongation at maximum force were

unchanged. Large increase in total elongation at maximum force was noted only for sample aged at the temperature of 600 °C.

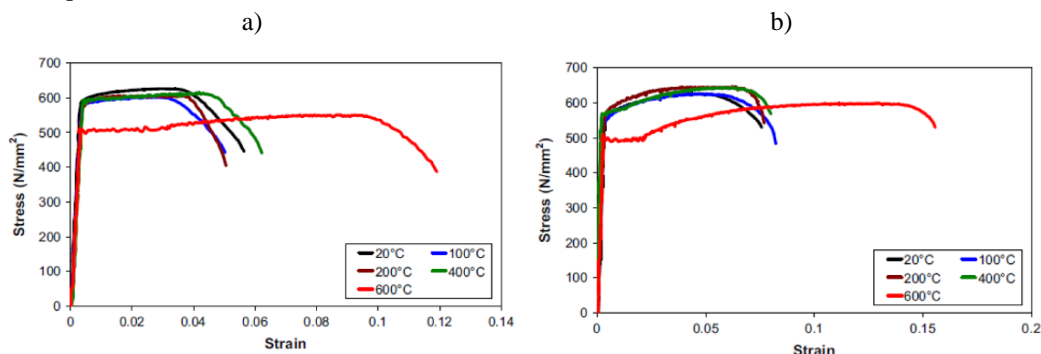

Figure 3. Stress-strain diagram for sample D6 (a) and sample D8 (b) exposed to ageing on different temperatures [3]

Different behaviour was noticed for cold shaped bars. Yield stresses of these bars were clearly detectable only on samples aged at the temperature of 600°C (Figure 3). This is a consequence of the loss of the cold deformation effects at very high temperatures, when these bars tend to behave similarly as hot rolled products. At the temperature of 600°C, the increase in total elongation at maximum force values was noticed for all the samples. At temperatures up to the 400°C, no significant changes in strength, ductility and stiffness of these samples were noted.

In another research conducted by Ahmad [4], the reinforcing bars of nominal diameter Ø20 mm were exposed to tensile tests, after ageing on the temperatures of 200 °C, 300 °C, 400 °C, 500 °C, 600 °C and 700 °C in duration of 30 min, 1 hour and 2 hours. After ageing, the samples were cooled to room temperature, and then tested.

The results of this study are shown in Table 3.

Table 3. Tensile tests results on reinforcing bars [4]

Type of specimen	Temperature (°C)	Duration (hours)	Yield strength (MPa)	Ultimate tensile strength (MPa)	Elongation (%)
Control	25 °C	0	684.2	764.3	25
Heated	200 °C	0.5	573.0	726.1	25
		1	573.2	745.2	28
		2	573.2	738.8	32
Heated	300 °C	0.5	554.1	719.8	35
		1	567.0	719.8	33
		2	560.5	732.5	28
Heated	400 °C	0.5	579.6	745.2	28
		1	579.6	745.2	29
		2	560.5	732.5	25
Heated	500 °C	0.5	600.0	758.0	18
		1	598.0	764.3	29
		2	579.0	732.5	28
Heated	600 °C	0.5	541.4	719.8	20
		1	560.5	719.8	26
		2	573.2	726.1	30
Heated	700 °C	0.5	465.0	598.7	32
		1	484.1	595.1	33
		2	452.2	582.2	35

It was shown that large scale reduction of mechanical properties (yield stress, tensile strength) was noticed only for samples tested on temperature of 700°C [4]. The length of the ageing process did not affect the obtained results.

Topçu and Karakurt [5] have tested hot rolled smooth reinforcing bars designated as S220 and ribbed bars designated as S420. Samples were aged at temperatures of 20 °C, 100 °C, 200 °C, 300 °C, 500 °C, 800 °C and 950 °C in duration of 3 h. After the exposure, samples were cooled down in air, to the room temperature, and then exposed to the tensile test.

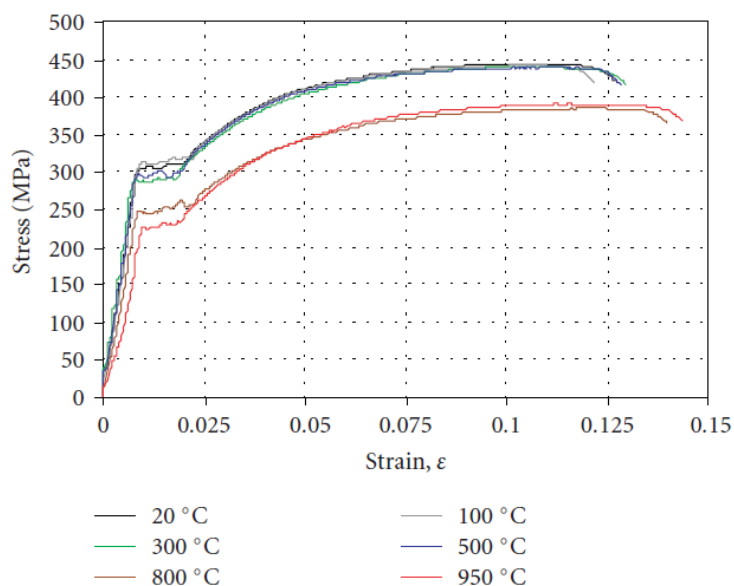

Figure 4. Stress-strain diagram for reinforcing steel S220 aged on different temperatures [5]

It was shown that the temperatures up to 500°C did not have greater influence on mechanical properties of steel S220. Significant reduction in strength and yield stress, and increase in ductility, were noticed at temperatures of 800°C and 950°C in both types of reinforcing steel products (as shown in Figure 4).

3. METHODOLOGY

The goal of the presented research was to determine the influence of the ageing defined according to the relevant standard SRPS EN 10080, on the mechanical and deformation properties of different reinforcing steel products. Having in mind that this standard defines that ageing of the samples should be performed at the temperature of $100 \pm 10^\circ\text{C}$, in duration of $1 \text{ h} \pm 15 \text{ min}$, this was one of the methods applied. In order to understand the influence of the duration of ageing process on the same properties, additional ageing methods in duration of 30 min and 2 hours were considered. The testing was conducted on the reinforced steel bars and coils (declared quality B500B) and reinforcing welded fabrics (declared quality B500A). Bars and coils were produced by hot rolling, while fabrics were prepared by spot welding of cold drawn bars.

Three samples for each type of reinforcing steel were chosen (bars, coils, fabrics), designated as „a“, „b“ and „c“, every sample 1000 mm long. Each of the samples was cut in 4 parts, making new samples of 250 mm in length. Parts obtained in this way were marked as 1, 2, 3 and 4. All the parts, marked with number 4, are shown in Figure 5. Bars and coils were tested in diameter of 10 mm, while fabric type Q221 had 6.5 mm bars in both directions.

All the samples for one type of product were taken from the same heat, in order to avoid differences in chemical composition and treatment of the samples. Each of the 4 parts marked 1-4 was exposed to one of the treatments, as shown in Table 4.

All the samples were tested using the tensile test with measurements of force and elongation until breakage. In this way, it was possible to form stress-strain diagrams for all the tested samples. These diagrams were used for analysis of the ageing effects on the values of yield stress, tensile strength and total elongation at maximum force. The testing was performed in the Laboratory of building materials, Faculty of Civil engineering University of Belgrade, using universal testing machine produced by „Shimadzu“, with range 0-300 kN and electrical extension meter produced by EDX, with maximum opening of 25 mm, and base length of 100 mm.

Table 4. Designation of the testing samples

Treatment	Marking of the samples		
	Bars	Coils	Fabrics
No ageing	š-a-1, š-b-1, š-c-1	k-a-1, k-b-1, k-c-1	m-a-1, m-b-1, m-c-1
30 min at T=100°C	š-a-2, š-b-2, š-c-2	k-a-2, k-b-2, k-c-2	m-a-2, m-b-2, m-c-2
1 h at T=100°C	š-a-3, š-b-3, š-c-3	k-a-3, k-b-3, k-c-3	m-a-3, m-b-3, m-c-3
2 h at T=100°C	š-a-4, š-b-4, š-c-4	k-a-4, k-b-4, k-c-4	m-a-4, m-b-4, m-c-4



Figure 5. Samples of bars, coils and welded fabrics that were prepared for the ageing at the temperature of 100°C in duration of 2 h

4. TESTING RESULTS AND DISCUSSION

Measured values of stress (σ) and strain (ϵ) acquired on the samples exposed to tensile testing are presented in Figures 6-8. It can be seen that σ - ϵ diagrams of reinforcing bars and coils, obtained by hot rolling, have clearly detectable yield stresses. However, stress-strain diagrams of welded fabrics (obtained through cold drawing) show that yield stress is not clearly defined for these products.

As it was expected, due to their ductility classes, elongation at maximal force was significantly lower for the samples taken from wired fabrics. Depending on the thermal treatment, elongations for the bars were between 10.3 and 10.7%, for coils between 9.8% and 9.9% and for fabrics between 2.6% and 3.1%. This is the consequence of the different production technologies. Cold drawing leads to uniform direction of the crystal grains and irreversible changes in crystal lattice, that influences increase in tensile strength and hardness of steel, and decrease in its ductility [6].

Ageing of the bar and coil samples at the temperature of 100°C in duration of 1 h and 2 h, led to mild increase of tensile strength and yield stress, when compared to the untreated samples, and samples aged in the duration of 30 minutes. For samples taken from coils, the highest influence of the treatment was noticed on the yield stress, which was increased by 7%, while tensile strength remained unchanged. The ductility of these samples (total elongation at maximum force), was reduced with the prolongation of the thermal treatment (see Table 5). However, if individual results of measured elongations are observed, for the samples designated as „a“, „b“ and „c“, both for bars and coils, the correlation between these values and the duration of the ageing process could not be determined.

When samples taken from the welded fabrics are considered, the differences in yield stresses and tensile strengths were very small. The lowest values of these stresses ($R_{eH}=612.9$ MPa and $R_m=638.8$ MPa), together with the highest values of total elongation at maximum force ($A_{gt}=3.1\%$) were reached on samples aged for one hour. On the contrary, samples aged for 2 hours showed the highest values of measured stresses ($R_{eH}=632.4$ MPa and $R_m=655.4$ MPa) and lowest elongations.

For coils and fabrics, the ratio between tensile strength and yield stress decreased with the prolonging of the thermal treatment. For reinforcing bars, it was not possible to determine correlation between these two parameters.

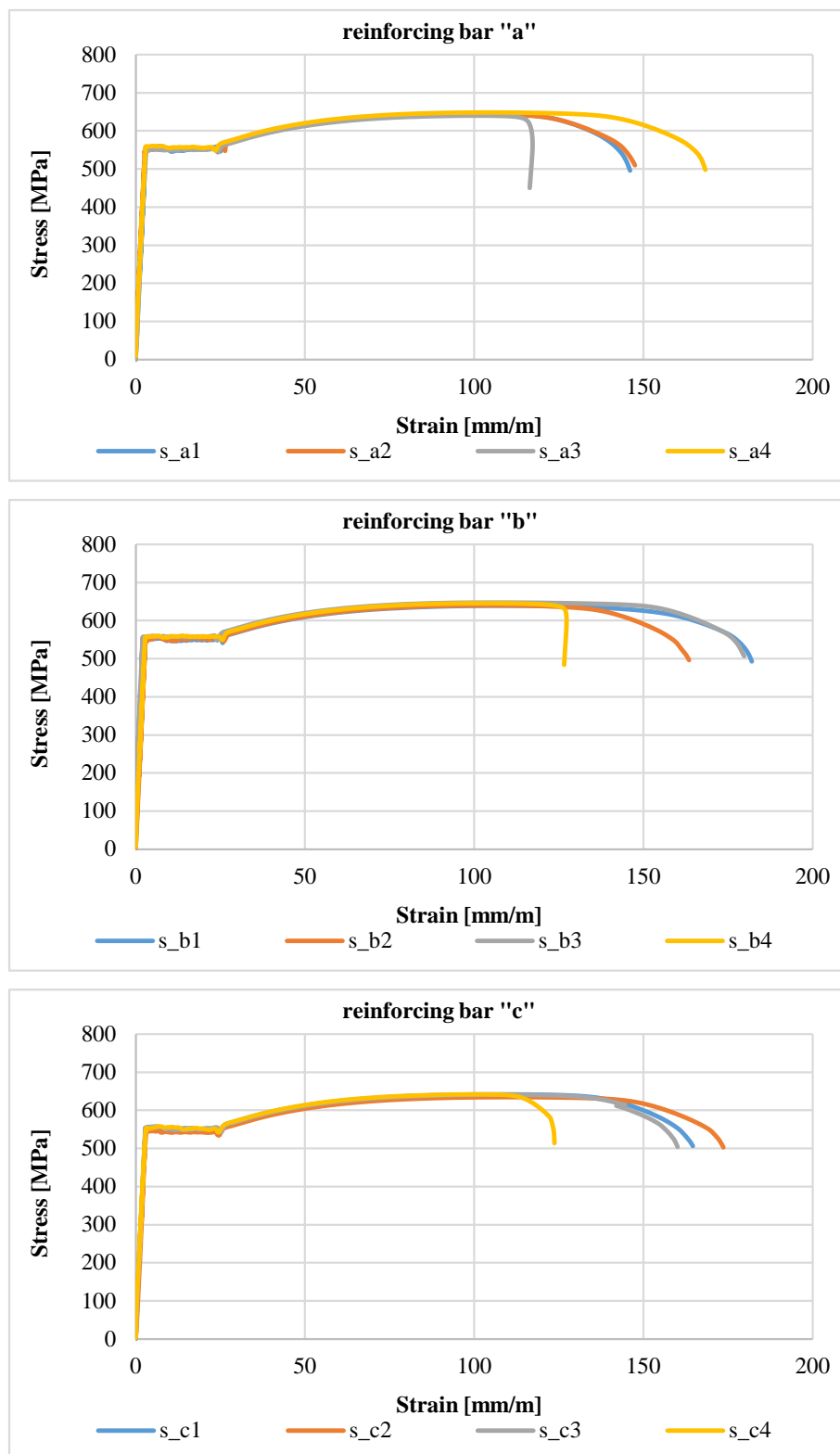

Figure 6. Stress-strain diagrams for reinforcing bars tested after different thermal treatments

The highest discrepancy of results, regarding all the measured parameters, was obtained for the samples taken from the welded fabrics. This may be the consequence of their production method, but this could be confirmed only after testing of larger number of samples for this type of product in the future.

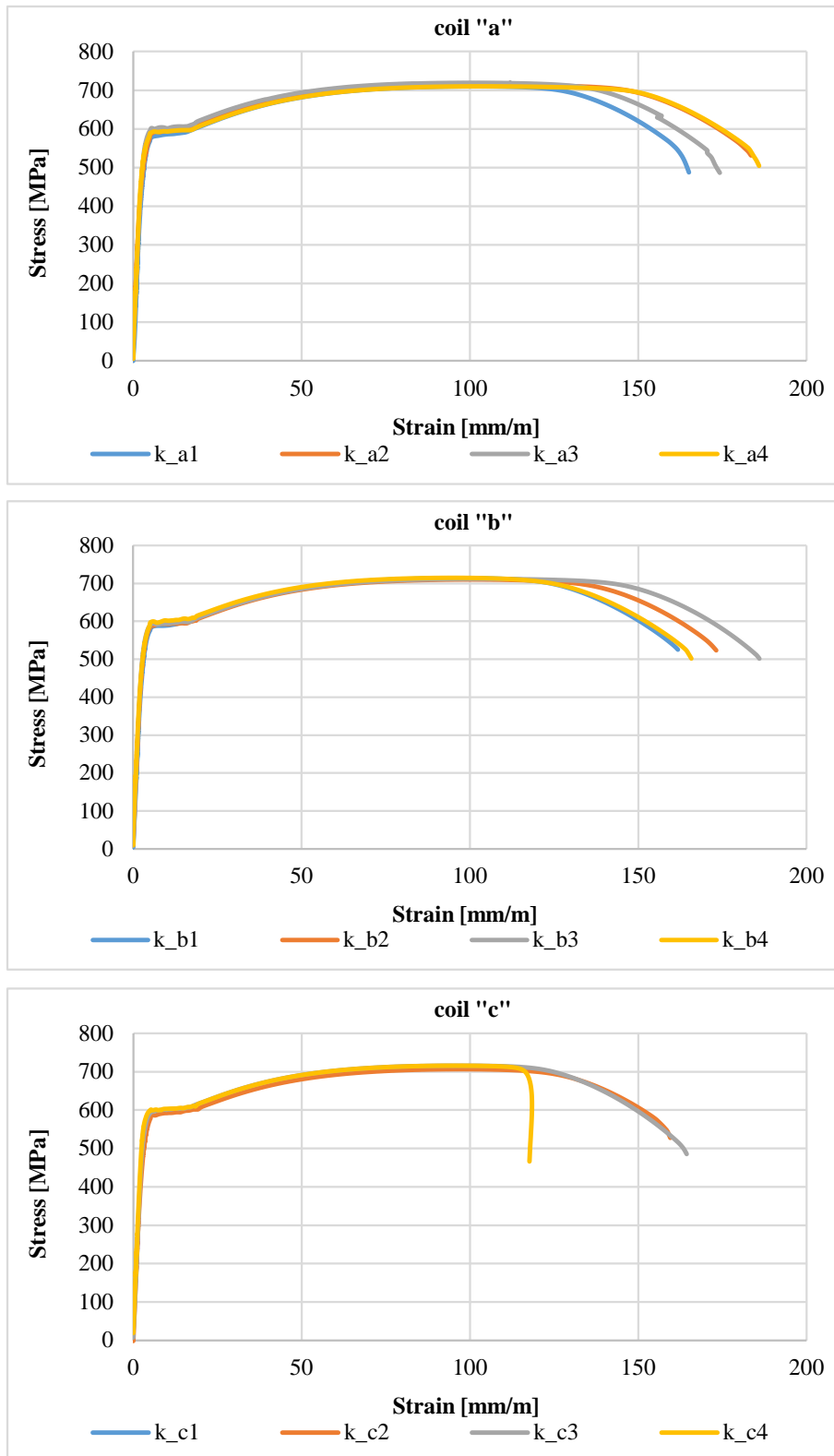

Figure 7. Stress-strain diagrams for reinforcing coils tested after different thermal treatments

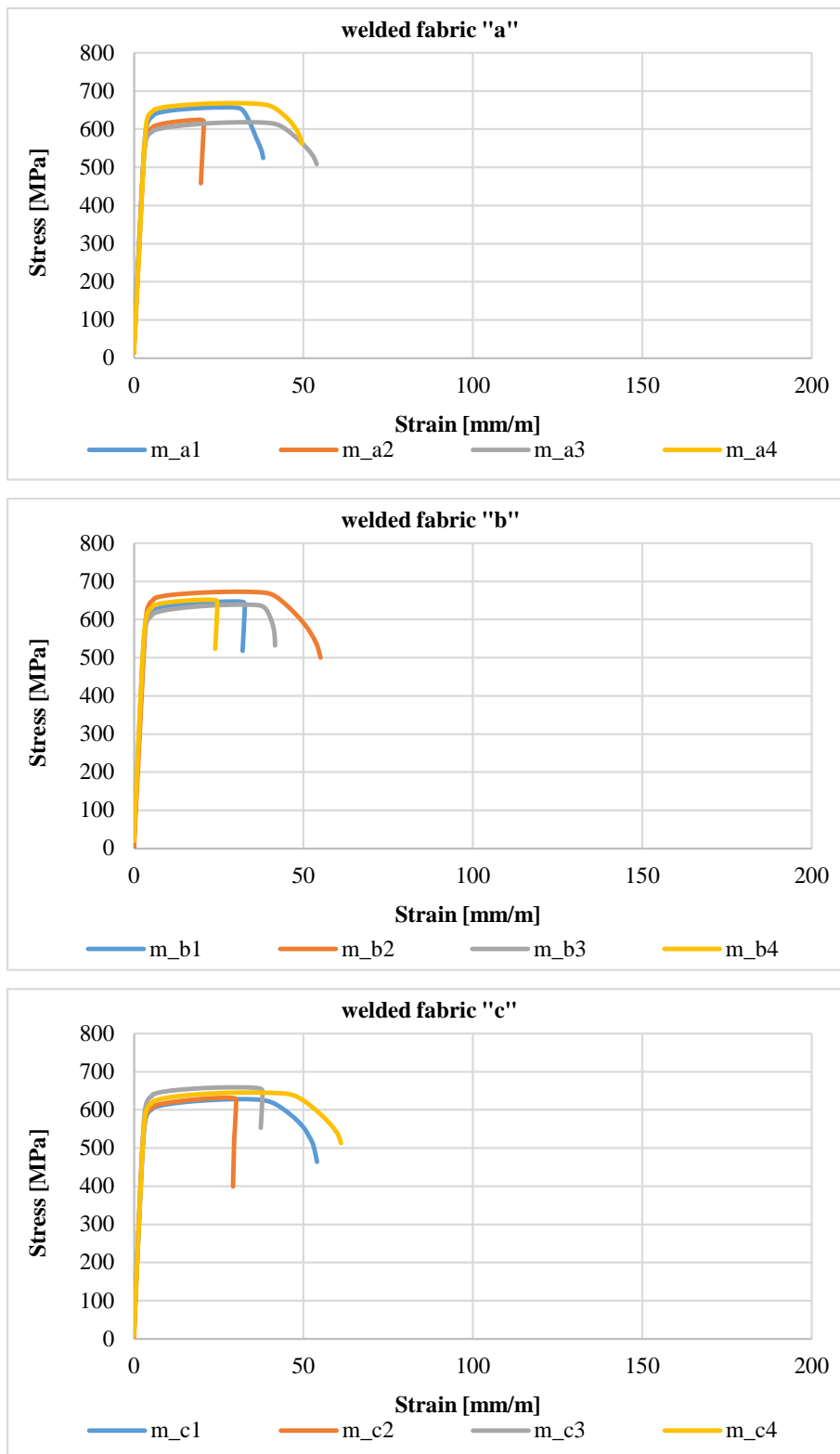

Figure 8. Stress-strain diagrams for welded fabrics tested after different thermal treatments

Table 5. Average values (standard deviations) of measured stress and strain on tested samples

Sample treatment	R_{eH} (MPa)	R_m (MPa)	R_m/R_{eH}	A_{gt} (%)	
No treatment	555.2 (2.99)	641.4 (2.49)	1.155	10.68 (0.23)	bars
Ageing for 30 min at 100°C	550.2 (3.99)	639.5 (4.11)	1.162	10.45 (0.31)	
Ageing for 1h at 100°C	554.9 (4.25)	642.7 (4.17)	1.158	10.57 (0.33)	
Ageing for 2h at 100°C	557.9 (2.70)	645.0 (3.23)	1.156	10.30 (0.21)	
No treatment	569.1 (5.38)	712.9 (2.69)	1.253	9.83 (0.42)	coils
Ageing for 30 min at 100°C	576.9 (5.77)	710.5 (3.69)	1.232	9.92 (0.45)	
Ageing for 1h at 100°C	590.3 (4.05)	715.6 (3.57)	1.212	9.80 (0.32)	
Ageing for 2h at 100°C	587.6 (8.97)	713.2 (3.10)	1.214	9.79 (0.70)	
No treatment	619.6 (17.23)	644.3 (14.85)	1.040	2.93 (0.57)	fabrics
Ageing for 30 min at 100°C	619.5 (27.40)	643.2 (26.02)	1.038	2.58 (0.91)	
Ageing for 1h at 100°C	612.9 (21.79)	638.8 (20.49)	1.042	3.14 (0.72)	
Ageing for 2h at 100°C	632.4 (15.43)	655.4 (11.71)	1.036	2.85 (0.51)	

5. CONCLUSION

The presented research was planned and performed in order to discuss the requirement of the standard SRPS EN 10080, prescribing that the reinforcing steel samples should be exposed to thermal treatment (ageing at the temperature of 100°C in duration of 1 hour). The duration of the ageing treatment was varied (30 min, 1 h and 2 h), as well as the type of the product treated (bars, coils and welded fabrics). After the treatment, samples were exposed to the tensile testing. Based on the acquired results, the following conclusions can be drawn:

- The most noticeable effect on the stress-strain diagram shape, was influenced by the production technology of the final products. Bars and coils were produced using the hot rolling procedure and thus showed pronounced yield stress and higher ductility, when compared to cold drawn wires applied in the welded fabrics production.
- Different duration of the thermal treatment at the temperature of 100°C did not show significant influence on the stress and elongation values. When compared to the reference samples, measured differences were not significant. This is in accordance with the findings in the literature, that greater changes in mechanical and deformation properties are noticeable when samples are exposed to temperatures higher than 400°C.
- Nevertheless, it was noticed that longer ageing process increased the yield strength of samples taken from coils. This parameter was increased by 7% when the ageing lasted for 1 h and 2 h. For welded fabrics, ageing in the duration of 1 hour, gave the optimal results for this type of product, reducing their mechanical properties and increasing their ductility. This is important due to the fact that production procedure of this steel reinforcement type generally has the opposite effect.

LITERATURE

- [1] M. Muravljev, *Grđevinski materijali*, Beograd, Grđevinska knjiga, 2007.
- [2] SRPS EN 10080:2008, "Steel for the reinforcement of concrete - Weldable reinforcing steel - General", 2008,
- [3] A. Elghazouli, K. Cashell and B. Izzuddin, "Experimental evaluation of the mechanical properties of steel reinforcement at elevated temperature", *Fire Safety Journal*, DOI:10.1016/j.firesaf.2009.05.004, 2009
- [4] M. S. Ahmad, "Effect of sustained elevated temperature on mechanical behavior of reinforcing bar", *Procedia Engineering* 173 (2017) 905 – 909,
- [5] I. Topçu and C. Karakurt, Properties of reinforced concrete steel rebars exposed to high temperatures, *Research Letter*, <https://doi.org/10.1155/2008/814137>, 2008,
- [6] F. Merritt and J. Ricketts, *Building design and construction handbook*, Sixth edition, The McGraw-Hill Companies, Inc, ISBN-13: 978-0070419995, 2001.

07

Research paper I Оригинални научни рад
DOI 10.7251/STP2215063P
ISSN 2566-4484



Marko Popović, University of Belgrade, mare381@gmail.com
Aleksandar Savić, University of Belgrade, sasha@grf.bg.ac.rs
Gordana Broćeta, University of Banja Luka, gordana.broceta@aggf.unibl.org
Branko Borozan, University of Belgrade, borozanb@gmail.com
Mihailo Štavljanin, University of Belgrade, mihailo.stavljanin@gmail.com

EXPERIMENTAL INVESTIGATION OF SCC WITH RECYCLED RUBBER AND RECYCLED CONCRETE AGGREGATE

Abstract

The replacement of natural aggregates (NA) with alternative aggregates in concrete can contribute to the sustainable development of the construction industry. This paper aims to present research investigating the effects of recycled concrete aggregate (RCA) and crumb rubber (CR) utilization on the performance of Self-Compacting Concrete (SCC) mixtures in both fresh and hardened states. For this purpose, SCC mixtures with three different replacement levels of CR - 0%, 20% and 30% by volume for fine aggregate and 100% coarse RCA were prepared along with the reference mixture containing NA only. To assess the effects of NA replacement, the physical and mechanical tests were conducted on prepared SCC mixtures and corresponding results were analysed and compared.

Keywords: Self-Compacting Concrete, rubber aggregate, recycled concrete aggregate

ЕКСПЕРИМЕНТАЛНА ИСПИТИВАЊА САМОУГРАЂУЈУЋЕГ БЕТОНА СА РЕЦИКЛИРАНОМ ГУМОМ И РЕЦИКЛИРАНИМ БЕТОНОМ У СВОЈСТВУ АГРЕГАТА

Сажетак

Замена природних агрегата (NA) алтернативним агрегатима у бетону може допринети одрживом развоју грађевинске индустрије. У раду је представљено истраживање утицаја рециклираног бетонског агрегата (RCA) и дробљене гуме (CR) на перформансе мешавина самоуграђујућег бетона (SCC) у свежем и очврслом стању. Припремљене су SCC мешавине са три различита нивоа замене CR - 0%, 20% и 30% запремине ситнозрног агрегата и 100% крупног RCA заједно са контролном мешавином која садржи само NA. Да би се проценили ефекти замене NA, извршена су испитивања физичких и механичких карактеристика припремљених SCC мешавина и одговарајући резултати анализирани и упоређени.

Кључне ријечи: самоуграђујући бетон, гумени агрегат, агрегат од рециклираног бетона

1. INTRODUCTION

The construction industry is characterised by a considerable demand for energy and natural resources. In addition, the environmental impact is increased by the waste originated in the processes of construction and demolition. With more than a third of the total amount of the waste produced, construction and demolition waste (CDW) is the largest waste stream in the EU [1]. Bearing in mind, in addition to the environmental effects, the economic and social impact of the construction industry, achieving sustainability in this sector is crucial.

Concrete is the most widely produced and used construction material. The rapid growth of population and urbanization is reflected in the construction at an accelerating rate. Constantly increasing concrete production puts an immense strain on material resources such as natural aggregates (NA), leading to their depletion and causing damage to the environment. In addition to the rapid expansion of the built environment, an increased number of structures that are no longer serviceable has resulted in a huge amount of construction and demolition waste worldwide. Although the data presenting a composition of CDW vary depending on the source, it is unquestionable that concrete contribution is among the major. One of the sustainable and environmentally friendly solutions that address both waste disposal and natural aggregate depletion is the recycling of waste concrete as aggregate in recycled aggregate concrete (RAC).

The apparently unrelatable environmental concern involves the management of end-of-life rubber tyres. Most of the worn-out tyres are discarded or buried in landfills, left to decompose on their own over many decades or sometimes even burned. Discarded tyres are a type of harmful solid waste known as “black pollution”. Rubber tyres are not readily biodegradable and their burning releases poisonous smoke that stays in the air for a long period of time, with a hazardous effect on living creatures. Moreover, residue leftover in form of powder contaminates the soil. As a result of the growing demand for vehicles, the number of waste tyres is continually increasing, making them a global environmental eyesore. A potential solution to this issue and previously mentioned natural aggregate depletion is using recycled rubber as aggregate in concrete.

Recycling of CDW and waste tyres as a partial or total replacement of natural aggregate in concrete is in accordance with circular economy principles, offering a potential way for making the construction industry more sustainable. In addition to beneficial environmental impacts, it provides significant job creation possibilities [2].

Recycled concrete aggregates are fine or coarse aggregates produced by crushing and processing waste concrete originating from demolished old concrete structures. Due to its production process, RCA is a two-phase composite material consisting of original NA and residual cement paste. High porosity and the presence of micro-cracks in old cement paste significantly affects the physical and mechanical properties and performance of RAC. In addition to that, the production process of RAC can potentially contribute to internal cracking [3]. As the main consequence of the above-mentioned aspects, RCA has higher water absorption (WA), causing problems when designing RAC mixtures. Thus, fast and reliable measurement of WA is a highly significant part of the assessment of RCA properties before the production of a new concrete mixture [4, 5]. The amount of water that RCA absorbs during mixture preparation reduces the water-cement ratio, causing workability problems. This should be solved by presoaking RCA in water before mixing all ingredients or adding an extra amount of water calculated based on WA measurements [6]. Because of that, an effective water-cement ratio was conducted, taking into account only the amount of water available for cement hydration, ie the difference between the total amount of water in the mixture and water absorbed by RCA. Recycled aggregate concrete can be described as three-phase material, with the presence of two interfacial transition zones (ITZ) – the “new” between recycled aggregate and cement paste and the “old” within RCA – between residual mortar and original NA (Figure 1). High WA of RCA reduces the water available to react with the cement, affecting the quality of the new ITZ, leading to a decrease in mechanical properties. Tam et al. [7] proposed a new mixing approach in which the whole process is divided into two phases with half of the total water amount introduced in each of them. It was experimentally confirmed that the two-stage mixing approach (TSMA) improves the quality of the new ITZ, enhancing the mechanical properties of RAC.

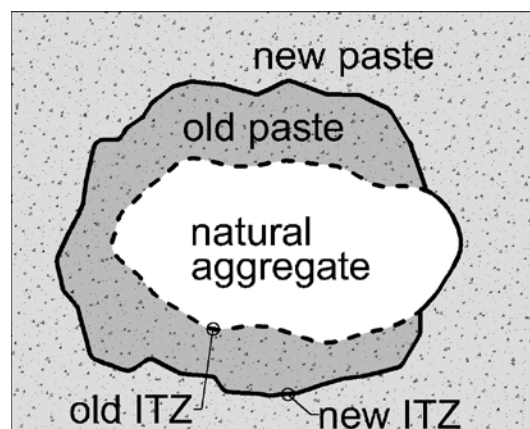

Figure 1. *Micro structure of the recycled aggregate concrete*

Rubber from recycled tyres can be used as a partial replacement of fine or coarse natural aggregate to produce the so-called “rubberized concrete”. Depending on the particle size, rubber aggregate can be classified as chips, crumb rubber and powder rubber [8]. Both fresh and hardened state properties of rubberized concrete are highly affected by the presence and the amount of rubber content. Hydrophobicity, surface roughness, and interlocking among rubber particles lead to higher porosity and entrapped air content in the mixture, potentially causing a workability problem [9]. Introduction of rubber in concrete mixture decrease compressive, flexural tensile and splitting strengths as well as modulus of elasticity, limiting structural application of crumb rubber concrete (CRC) [8–11]. Rubber particles are much more deformable than surrounding cement paste, which results in the development of microcracks in concrete under load. Because of the poor chemical interaction, the adhesion between rubber aggregate and the surrounding cement matrix is weak [8]. Porous ITZ with a lack of bonding reduces the strength values of CRC. The negative effects of NA replacement with rubber aggregates can be mitigated by optimizing the mix ratio and pretreatment of rubber particles with an aim to improve the ITZ. Along with previously mentioned negative effects, using the rubber aggregate can increase the sound insulation, frost resistance, ultimate strain, fatigue life, toughness and enhance the dynamic performance of concrete structures [8–11].

Self-compacting or self-consolidating concrete (SCC) is considered to be the concrete of the future [12]. SCC can be described as high-flowable concrete that is able to completely fill the formwork, encapsulating reinforcement even in congested arrangement, placed and consolidated under its own weight and without segregation or bleeding. Therefore, SCC doesn't need vibration after pouring, improving the productivity and working conditions during construction. In comparison with normally vibrated concrete (NVC), SCC possesses higher strength and enhanced durability and provides an increasing degree of architectural freedom to carry out more complex geometries in structural design. One of the key factors enabling the development of SCC was the advancement of highly efficient cement dispersants - superplasticizers. The advancements of superplasticizers based on polycarboxylate technology provided the achievement of new capabilities in terms of the production, placement, and service life of high-quality SCC mixtures. Replacing materials from natural resources with industrial by-products can make SCC more sustainable. One of the examples is replacing NA with sustainable alternative aggregates such as RCA and CR. In this paper, the feasibility of such replacement is studied in terms of the performance of SCC mixtures in both fresh and hardened states.

2. EXPERIMENTAL CAMPAIGN

2.1. SCOPE AND OBJECTIVE

The aim of this study is to provide an overview of the ongoing insights in research exploring the influence of the recycled concrete aggregate and crumb rubber on physical and mechanical properties of self-compacting concrete mixtures. In order to examine the feasibility of natural aggregate replacement with recycled aggregate, several concrete mixtures with different replacement levels were prepared.

Aggregate was divided into three standard fractions: I (0/4 mm), II (4/8 mm) and III (8/16 mm). Natural fine aggregate (fraction I) was replaced by CR at three levels of volumetric replacement - 0%, 20% and 30%, while natural coarse aggregate (fractions II and III) was replaced by RCA with

replacement ratio of 0% and 100%. A total of four SCC mixtures were defined and their designation and content of aggregate fractions are presented in Table 1.

To compare the impact that combinations of various RCA and CR replacement ratios have on SCC properties, testing of fresh and hardened concrete was carried out and determined properties of studied mixtures were compared to reference concrete.

Table 1. Labels of studied mixtures

	REF	R ₀ C ₁₀₀	R ₂₀ C ₁₀₀	R ₃₀ C ₁₀₀
CR %	0	0	20	30
RCA %	0	100	100	100

2.2. MATERIALS

Three types of aggregate were used in the concrete mixtures (Figure 2):

- Natural river aggregate separated in three fractions: 0/4 mm, 4/8 mm, 8/16 mm
- Coarse recycled concrete aggregate separated in two fractions - 4/8 mm and 8/16 mm
- Crumb rubber as fine aggregate - 0/4 mm.

Separation of aggregate into fractions was done according to EN 933-1:2012 [13].

Recycled concrete aggregate used in this study was obtained by crushing a 30-year-old base structure for tram tracks. Based on the results of performed tests it was concluded that the original concrete satisfied the conditions for class C35/45 at the moment of crushing. The RCA composition was as follows: 98% base concrete, 1.2% asphalt and 0.8% brick debris. High water absorption of RCA has a negative impact on SCC workability and strength that might be considerable. This is especially the case with fine RCA which has led to it being largely not recommended. According to the above mentioned, only coarse RAC was used in mixtures considered in this experimental campaign with WA values of 3% for fraction II and 4.1% for fraction III.

Crumb rubber - a recycled rubber produced from scrap tires was used as fine aggregate. CR particles were not pre-treated before incorporation into the concrete mixture.

The cement used in this study was Portland-composite cement CEM II/A-M(S-L)42,5R, consisting of 80–94% Portland cement clinker, 6–20% ground slag and limestone and 0–5% gypsum and mineral fillers.

Powder type SCC mixtures were prepared using the fine-grained limestone filler with particle size under 0.125 mm, superplasticizer and water from the city water-works.



Figure 2. Constituents of studied SCC mixtures – limestone powder (LP), natural aggregate fractions I, II and III (NA I, NA II, NA III), crumb rubber (CR) and recycled concrete aggregate fractions II and III (RCA II, RCA III)

2.3. MIXTURES

Four SCC mixtures were defined with the equal effective water-cement ratio – $w/c_{\text{eff}} = 0.45$. Due to the higher water absorption of recycled concrete aggregate, mixtures containing RCA had an additional amount of water in comparison with reference concrete. All mixtures are classified as powder type SCC as they were made with high powder content and low water-powder ratio. The quantities of powder materials were kept constant - 630 kg/m^3 of which 380 kg/m^3 of cement and 250 kg/m^3 of filler. Superplasticizer was also applied in the same amount for all mixtures, so similar values of slump flow were expected. The composition of studied mixtures is presented in Table 2 and illustrated in Figure 3.

Table 2. Composition of mixtures (kg/m^3)

Mixture		REF	R ₀ C ₁₀₀	R ₂₀ C ₁₀₀	R ₃₀ C ₁₀₀
Cement		380			
Limestone powder		250			
Fraction I (0/4 mm)	NA	860	860	688	602
	CR	0	0	71,3	107
Fraction II (4/8 mm)	NA	530	0	0	0
	RCA	0	530	530	530
Fraction III (8/16 mm)	NA	310	0	0	0
	RCA	0	310	310	310
Water		171,0	199,6	199,6	199,6
Superplasticizer		4,4			



Figure 3. Specimen fracture surface of SCC mixture made with CR as partial replacement of fine aggregate and 100% coarse RCA

2.4. CONCRETE MIXING AND SPECIMEN PREPARATION

Porosity and water absorption capacity of RCA have significant impact on SCC mixture performance in fresh and hardened states.

The presence of attached old mortar in the RCA consumes more water leading to a lack of water required for hydration of new cement, affecting the quality of ITZ between RCA and new cement paste. In order to improve the new ITZ, two-stage mixing approach (TSMA) was conducted. In TSMA, as the name suggests, the whole mixing process is divided into two parts and the required water is split accordingly into two parts that are added at different timing (Figure 4). At the beginning, fine and coarse aggregates are mixed for 60 seconds. After that, half of the required water is added and mixed for another 60 seconds. In the next stage, the total quantity of cement is introduced into the mixture and mixed for 30 seconds before the remaining half of water is added and final mixture mixed for 120 seconds. The water incorporated in the first stage can generate a thin layer of cement slurry on the RCA surface that penetrates and fills up the pores and cracks in

the residual mortar, resulting in denser and stronger ITZ and therefore enhanced mechanical properties of concrete made with RCA. Limestone filler was introduced in the first stage, along with aggregates.

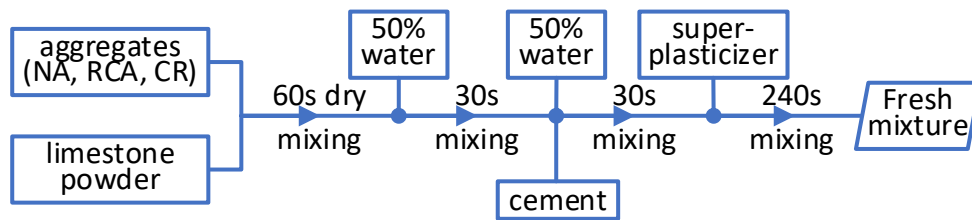

Figure 4. Mixtures preparation using two-stage mixing approach (TSMA)

2.5. TESTING METHODS

Performance of four prepared SCC mixtures, both in fresh and hardened state, was evaluated and compared [14].

The filling ability and stability of studied mixtures in the fresh state was determined according to three tests. Flowability and viscosity were quantitatively evaluated by the slump flow and t500 slump time test [15] and V-funnel test [16], while the L-box test [17] was used to measure the passing ability of mixtures.

In hardened state, the following mechanical properties were determined by tests carried out: compressive strength [18], flexural tensile strength [19], static and dynamic modulus of elasticity [20, 21], ultrasonic pulse velocity [22].

Influence of different aggregates on durability of prepared mixtures was assessed based on depth of penetration of water under pressure (concrete water impermeability) [23].

3. RESULTS AND DISCUSSION

3.1. FRESH MIX PROPERTIES

Results of conducted fresh concrete tests are summarized in Table 3.

Bulk density of fresh SCC [24] ranged between 2207 kg/m³ (mixture R₃₀C₁₀₀ with the highest aggregate replacement ratio) and 2405 kg/m³ (REF - reference mix). All presented mixtures satisfied both filling ability and passing ability of SCC. However, it was observed that the replacement of coarse NA with RCA (mixture R₀C₁₀₀), as well as additional replacement of fine NCA with crumb rubber (mixtures R₂₀C₁₀₀ and R₃₀C₁₀₀), decreased the concrete fresh state performance.

Table 3. Properties of mixtures in fresh state

Mixture	Slump flow		V-funnel	L-box
	diameter (mm)	t500 (s)	time (s)	PA (/)
REF	840	2,2	9,3	0,99
R ₀ C ₁₀₀	790	2,4	12,4	0,88
R ₂₀ C ₁₀₀	770	3,1	13,4	0,88
R ₃₀ C ₁₀₀	730	3,5	16,6	0,85

The slump flow test [15] was performed to assess flowability and flow rate of prepared SCC mixtures in the absence of obstructions. Based on the slump flow diameter values (varied between 730 mm and 840 mm), mixtures were classified in terms of flowability - R₃₀C₁₀₀ mix was classified as SF2, while all the other mixtures as SF3 class. The plastic viscosity is associated with speed of flow, and therefore can be assessed by the t500 slump time. Time t500 ranged between 2,2 s and 3,5 s, so all mixtures are categorized as VS2. V-funnel test [16] results were correlated with t500 values - all mixtures satisfied VF2 class requirements. To notice, with the increment of RCA and CR content flowability showed decreasing trend, while trend of increase was observed in the case of viscosity.

Ability of SCC mixes to flow through tight openings between obstructions like reinforcing bars without segregation or blocking was estimated using the L-box three bar test [17]. Passing ability of

studied mixtures was classified as PA2 and no blocking effect was observed. The highest PA value was estimated for REF mix, while mixtures with 100% coarse RCA had similar values, meaning that the decrease of passing ability showed negligible for CR replacement levels up to 30% of fine aggregate volume.

3.2. HARDENED CONCRETE PROPERTIES

Testing on hardened concrete was conducted for all four mixtures after 28 days to determine the compressive and flexural strength, static and dynamic modulus of elasticity, ultrasonic pulse velocity (UPV) and impermeability.

Compressive strength tests were performed on 150 mm cube specimens in accordance with EN 12390-3 [18]. The relationship between mixtures and estimated compressive strength is presented in Figure 5. Mixture R_0C_{100} had slightly lower compressive strength than reference (3%), while mixtures $R_{20}C_{100}$ and $R_{30}C_{100}$ had 26% and 45% lower values respectively.

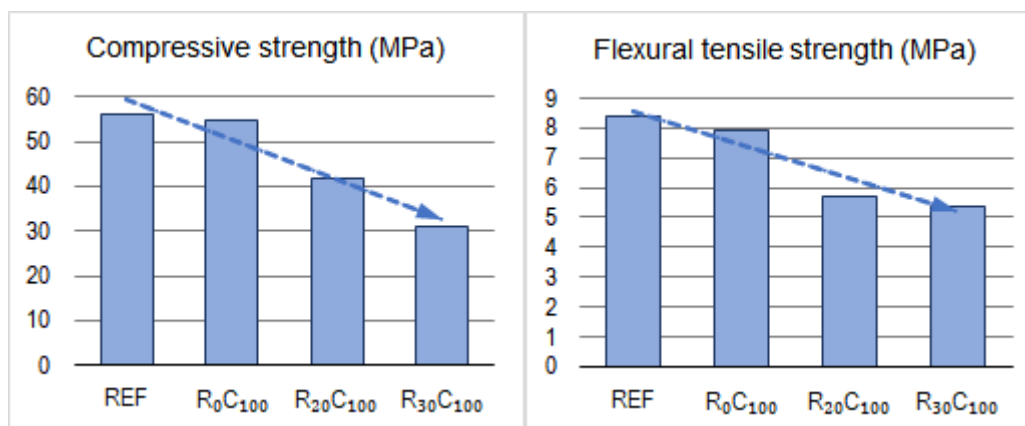

Figure 5. Compressive strength and flexural tensile strength of prepared SCC mixtures

Tensile strength of concrete was indirectly measured by three-point-bending test on prismatic specimens (120x120x360 mm, 300 mm span) [19]. Mixture containing natural aggregate only had highest strength, while the total replacement of coarse NA with RCA decreased strength value by 6%. Additional partial replacement of fine NA with CR had much bigger impact on flexural strength – the reduction was up to 36% for mixture with 30% fine CR and 100% coarse RCA.

It is well known that there is general correlation between compressive strength and modulus of elasticity of concrete [25]. Therefore, in accordance with previously presented results, it is expected that the replacement of NA with RCA and CR has significant impact on the elastic modulus of SCC. Static and dynamic modulus of elasticity were obtained for prepared mixtures. Static modulus of elasticity test was carried out in accordance with EN 12390-13 [20], while dynamic modulus was determined based on resonant frequency method [21]. As can be seen from the Figure 6, dynamic and static modulus of elasticity showed similar decreasing trend with the increase of CR and RCA content. In comparison with the reference mixture, mixture R_0C_{100} had 12% lower static modulus and 10% lower dynamic modulus, while $R_{30}C_{100}$ had decrease of 40% and 35% respectively.

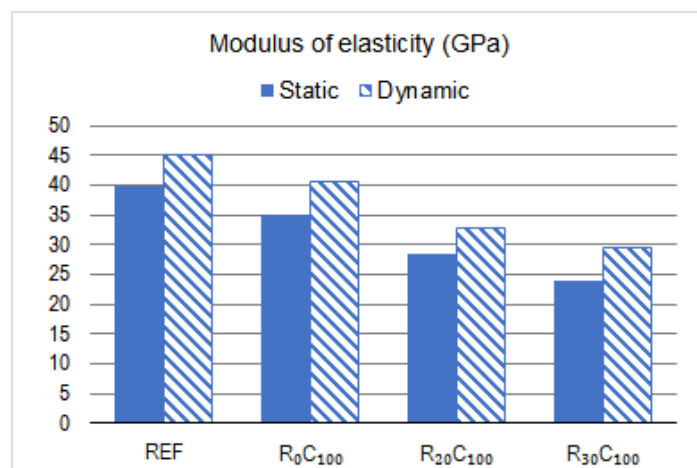

Figure 6. Static and dynamic modulus of elasticity of studied mixtures

In order to assess the quality and homogeneity of mixtures containing recycled aggregate, ultrasonic pulse velocity (UPV) test [22] was carried out. The UPV value is very sensitive to the presence of discontinuities in concrete like cracks and voids. As said before, recycled concrete aggregate contains old mortar which has high porosity. Therefore, it is expected that mixtures with replacement of natural aggregate with recycled concrete aggregate have lower values of UPV. The crumb rubber aggregate has a low value of elastic modulus and the addition of CR to mixture increases the air content, which all leads to pulse velocity reduction. The results of UPV measurement conducted on specimens made of considered mixtures are in line with previous considerations (Figure 7). The UPV values varied between 4073 m/s and 4639 m/s; the control mixture had the highest UPV value that decreased by 4% for mixture R_0C_{100} , 10% and 12% for mixtures $R_{20}C_{100}$ and $R_{30}C_{100}$ respectively. In accordance with the UPV classification criterion for concrete quality grading given in Table 4, the REF mixture was classified as “excellent”, while the rest fell within the range of “good”.

Table 4. Classification of concrete quality according to UPV [26]

UPV (m/s)	Concrete quality
Above 4500	Excellent
3500 – 4500	Good
3000 – 3500	Medium
Below 3000	Doubtful

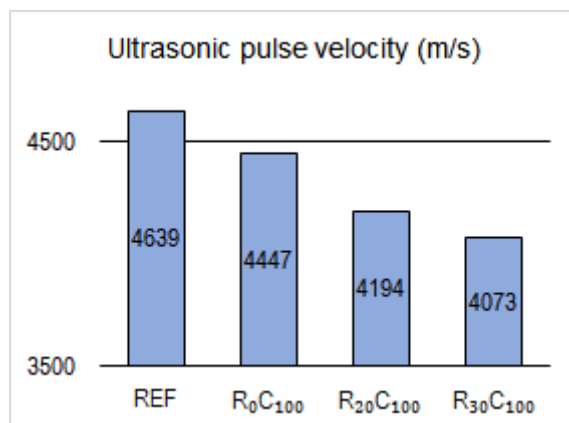

Figure 7. Ultrasonic pulse velocity (UPV) of prepared mixtures

The water permeability is a significant indicator of concrete performance regarding durability – increased water tightness is of critical interest for freeze-thaw and chemical attack resistance. The influence of NA replacement with RCA and CR on water permeability of SCC mixtures was assessed on cylindrical specimens (150 mm x 150 mm) based on the depth of penetration of water under pressure. Porosity and high water absorption of RCA have a substantial influence on permeability, making it directly related to the RCA replacement level [3, 6]. However, in the case of the TSMA, the cement gel surrounding the RCA reduces the porosity of old adhered mortar and provides impermeability improvement [27]. The incorporation of crumb rubber as aggregate increases water permeability [8]. Because of the weak bond between CR and surrounding cement paste, voids and micro-cracks in ITZ, the depth of pressurized water penetration into the concrete increases. The conducted testing (Figure 8) showed that coarse RCA and fine CR aggregates usage increases penetration depth. Based on these results, mixtures were classified with respect to their water permeability (SRPS U.M1.206 [28]): the reference mixture belongs to highest class – “V-III”, R_0C_{100} and $R_{20}C_{100}$ to class “V-II”, while the average value of penetration depth for $R_{30}C_{100}$ slightly exceeds the 30 mm threshold, classifying it as “V-I”. Despite the decrease in water permeability, all mixtures had penetration depths of less than 50 mm which classifies them as “impermeable”, while R_0C_{100} and $R_{20}C_{100}$ can be classified as “impermeable under aggressive conditions” thanks to depths under 30 mm [25].

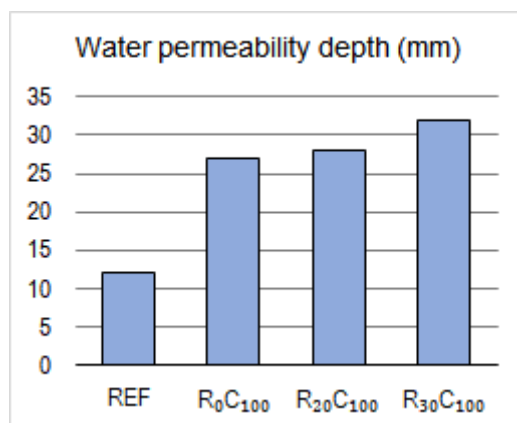

Figure 8. Water permeability test – depth of penetration of water under pressure

4. SUMMARY AND CONCLUSIONS

This study was aimed to investigate the influence of coarse recycled concrete aggregate and untreated crumb rubber as a partial fine aggregate replacement on SCC properties. The series of tests was conducted on specimens made from four different SCC mixtures: the reference mixture prepared with only natural aggregates and three mixtures with 100% coarse RCA and volumetric replacement of fine NA with CR at three levels – 0%, 20% and 30%. The mixtures were made using the two-stage mixing approach (TSMA), with the addition of limestone filler in premix and the equal effective water-cement ratio of 0.45 and the maximum aggregate particle size set at 16 mm. To compare the impact of two natural aggregate substitutions on fresh as well as hardened concrete, a range of measurements were carried out on prepared mixtures in fresh and hardened state. Based on the results and discussion presented in previous chapter, the following conclusions can be drawn:

- By replacing the coarse NA with RCA and with the increment of CR content, the flowability decreased while viscosity increased. Mixture R₃₀C₁₀₀ reached SF2 flowability class, while the other mixtures were classified as SF4. According to flow time values measured during the slump flow and V-funnel tests, all mixtures belonged to VS2/VF2 class.
- In terms of passing ability, the replacement of NA had an acceptable impact - all mixtures achieved the PA2 level. The mixture with coarse RCA had passing ability decreased by 11%, while the incorporation of CR had negligible results on the performance.
- The coarse RCA replacement had a minor effect on the values of compressive and flexural tensile strength. Contrary to that, untreated rubber aggregate considerably decreased both strength values.
- The static modulus of elasticity decreased with RCA and CR content increment up to 40%. Similar decreasing trend was observed in case of dynamic modulus of elasticity.
- According to UPV values, all three mixtures containing replacement aggregate showed quality graded as “good” with velocities high above the threshold, while the reference mixture had “excellent” quality.
- The usage of RCA and CR significantly increased the water permeability – up to 167% for highest level of replacement. The biggest change was obtained for mixture with 100% coarse RCA – penetration depth increased by 125%. Therefore, in terms of water permeability, RCA and CR can negatively impact the durability of concrete. However, mixtures with CR replacement levels up to 20% were classified as “impermeable under aggressive conditions” and R₃₀C₁₀₀ as “impermeable”.

LITERATURE

- [1] “Waste statistics.” Internet: https://ec.europa.eu/eurostat/statistics-explained/index.php?title=Waste_statistics, [10.02.2022.].
- [2] European Commission, Directorate-General for Internal Market, Industry, Entrepreneurship and SMEs, *3rd Raw Materials Scoreboard : European innovation partnership on raw materials*, Publications Office, 2021, Available: <https://data.europa.eu/doi/10.2873/680176>, [10.02.2022.].
- [3] M. Pepe, *A Conceptual Model for Designing Recycled Aggregate Concrete for Structural Applications*. Springer Theses, 2015.

- [4] N. Tošić, A. Savić, and V. Carević, "A method for the continuous measurement of water absorption of coarse recycled aggregates," in *Proceedings of the ASES Symposium 2016*, Zlatibor, Serbia, Sep. 2016, pp. 1023-1030.
- [5] A. Savić, M. Aškračić, B. Kovačević, and D. Pavlović, "Properties of SCC Mixtures with Coarse Recycled Aggregate," in *Proceedings of 15th Conference hosted by Association of Structural Engineers of Serbia - ASES*, Zlatibor, Serbia, Sep. 2018, pp. 265-274.
- [6] M. C. Rao, S. K. Bhattacharyya, and S. V. Barai, *Systematic Approach of Characterisation and Behaviour of Recycled Aggregate Concrete*. Springer Transactions in Civil and Environmental Engineering, 2019.
- [7] V. W. Y. Tam, X. F. Gao, and C. M. Tam, "Microstructural analysis of recycled aggregate concrete produced from two-stage mixing approach," *Cement and Concrete Research*, vol. 35, no. 6, pp. 1195-1203, 2005.
- [8] J. Xu, Z. Yao, G. Yang, and Q. Han, "Research on crumb rubber concrete: From a multi-scale review," *Construction and Building Materials*, vol. 232, pp. 117282-117306, 2020.
- [9] S. Raffoul, R. Garcia, K. Pilakoutas, M. Guadagnini, and N. F. Medina, "Optimisation of rubberised concrete with high rubber content: An experimental investigation," *Construction and Building Materials*, vol. 124, pp. 391-404, 2016.
- [10] Y. Li, S. Zhang, R. Wang, and F. Dang, "Potential use of waste tire rubber as aggregate in cement concrete – A comprehensive review," *Construction and Building Materials*, vol. 225, pp. 1183-1201, 2019.
- [11] H. Liu, X. Wang, Y. Jiao, and T. Sha, "Experimental Investigation of the Mechanical and Durability Properties of Crumb Rubber Concrete," *Materials*, vol. 9, no. 3, 2016.
- [12] S. Mindess, "Self-compacting concrete (SCC)" in *Developments in the formulation and reinforcement of concrete*, 2nd edition. Woodhead Publishing, Duxford, United Kingdom, 2019.
- [13] EN 933-1:2012 - Tests for geometrical properties of aggregates - Part 1: Determination of particle size distribution - Sieving method. CEN, Brussels, 2012.
- [14] EFNARC. (2005.). *The European Guidelines for Self-Compacting Concrete; Specification, Production and Use*. [On-line]. Available: www.efca.info/download/european-guidelines-for-self-compacting-concrete-scc/?wpdmdl=652 [10.02.2022.]
- [15] EN 12350-8:2019 - Testing fresh concrete - Part 8: Self-compacting concrete - Slump-flow test. CEN, Brussels, 2019.
- [16] EN 12350-9:2010 - Testing fresh concrete - Part 9: Self-compacting concrete - V-funnel test. CEN, Brussels, 2010.
- [17] EN 12350-10:2010 - Testing fresh concrete - Part 10: Self-compacting concrete - L box test. CEN, Brussels, 2010.
- [18] EN 12390-3:2019 - Testing hardened concrete - Part 3: Compressive strength of test specimens. CEN, Brussels, 2019.
- [19] EN 12390-5:2019 - Testing hardened concrete - Part 5: Flexural strength of test specimens. CEN, Brussels, 2019.
- [20] EN 12390-13:2021 - Testing hardened concrete - Part 13: Determination of secant modulus of elasticity in compression. CEN, Brussels, 2021.
- [21] SRPS U.M1.026:1993 - Concrete - Determination of the dynamic modulus of elasticity and Poisson's ratio. Institute for standardization of Serbia, Belgrade, Serbia, 1993.
- [22] EN 12504-4:2021 - Testing concrete in structures - Part 4: Determination of ultrasonic pulse velocity. CEN, Brussels, 2021.
- [23] EN 12390-8:2019 - Testing hardened concrete - Part 8: Depth of penetration of water under pressure. CEN, Brussels, 2019.
- [24] EN 12350-6:2019 - Testing fresh concrete - Part 6: Density. CEN, Brussels, 2019.
- [25] A. M. Neville, *Properties of concrete*, 5th ed. Harlow, England: Pearson, 2011.
- [26] British Standards Institution, Specification for testing concrete. Part 203. British Standards Institution, London, 1986.
- [27] V. W. Y. Tam and C. M. Tam, "Assessment of durability of recycled aggregate concrete produced by two-stage mixing approach," *Journal of Materials Science*, vol. 42, no. 10, pp. 3592-3602, 2007.
- [28] SRPS U.M1.206:2013 - Specification, performance, production and conformity - Rules for the implementation of SRPS EN 206-1. Institute for standardization of Serbia, Belgrade, Serbia, 2013.

08

Research paper I Оригинални научни рад
DOI 10.7251/STP2215073G
ISSN 2566-4484



Draženko Glavić, University of Belgrade, Faculty of Transport and Traffic Engineering,
drazenglavic@gmail.com

Marina Milenković, University of Belgrade, marina.milenkovic@sf.bg.ac.rs

Dragan Topić, Putevi i ulice d.o.o. Banja Luka, dragantopic@yahoo.com

MULTI-CRITERIA ANALYSIS OF COMPROMISE ROAD ALIGNMENT SOLUTION FOR ROUTE 2A - SECTION KRUPA TO BOČAC

Abstract

The subject of this analysis is the selection of the road alignment of Route 2a on the section Krupa - Bočac (Republic of Srpska). The complexity of the problem is reflected in the fact that a number of conflicting criteria of different stakeholders should be taken into account; i.e. criteria that are important from the aspect of road managers, criteria from the aspect of users and criteria society as a whole. The PROMETHEE method was used to determine compromise solution. Detailed comparative analysis of all parameters showed that variant 0 of the Krupa - Bočac section is a first ranked compromise solution. Sensitivity analysis has shown that the first place is stable by most criteria. Decision support framework presented in this paper can help future researchers and decision makers with similar problem.

Keywords: MCDM, Route 2a, Criteria, Road alignment.

ВИШЕКРИТЕРИЈУМСКА АНАЛИЗА КОМПРОМИСНОГ РЕШЕЊА ТРАСЕ ПУТА ЗА РУТУ 2А - ДЕОНИЦА КРУПА - БОЧАЦ

Сажетак

Предмет ове анализе је избор трасе руте 2а на деоници Крупа – Бочац (Република Српска), на основу дефинисаних варијантних решења. Комплексност проблема огледа се у чињеници да треба узети у обзир бројне конфликтне критеријуме различитих интересних група – критеријуме који су важни како са аспекта управљача пута, тако и са аспекта корисника и друштва у целини. За решавање овог проблема коришћен је PROMETHEE метод. Детаљном анализом свих параметара утврђено је да је варијанта 0 деонице Крупа - Бочац компромисно прво рангирано решење. Анализа осетљивости је показала да је прво место стабилно по већини критеријума. Оквир за подршку одлучивању приказан у овом раду може послужити истраживачима и доносиоцима одлука приликом решавања сличних проблема.

Кључне ријечи: MCDM, Рута 2а, Критеријуми, Траса пута.

1. INTRODUCTION

1.1. GENERAL DATA ON THE EXISTING ROAD NETWORK

The main road network in the Republic of Srpska (RS) covers about 4,200 km of roads, of which about 3,600 km are roads with modern asphalt pavement. Roads are classified as main roads (approximately 1,900 km) and regional roads (approximately 2,300 km). About 320 km of the main road network are part of the European road network. This basic road network is also increased by 227 km of local roads, which were declared important for the functioning of the total traffic on the territory of the Republic of Srpska by special decisions of the Government of the RS, and handed over to the PE "Roads of the RS" for management.

In terms of importance for network from the transport aspect, there are two main routes in the Republic of Srpska, where most of the transport takes place. These are the northern direction that runs from the borders of Croatia, Novi Grad, through Prijedor, Banja Luka, Derвента, Modriča, Brčko and Bijeljina to the border with the Republic of Serbia and the eastern direction that runs from Bijeljina through Zvornik, Vlasenica, Han Pijesak, Istočno Sarajevo, Rogatica, Novo Goražde, Foča, Gacko to Trebinje, from where it separates towards the borders of Croatia and Montenegro. The total length of the north route is about 335 km, while eastern route is about 390 km.



Figure 1. Road network of Republic of Srpska

The route of the subject road is located on the area between two local communities, the town Banja Luka and in smaller part, municipality Mrkonjic Grad. SECTION I, II and III of the route Banja Luka – Mrkonjic Grad represent an alignment of the main road M-16 (according to new road classification MI-101), that is at the same time defined within the European road network as E-661. These particular sections of the main road are located on the territory of the Republic of Srpska and therefore are under direct jurisdiction of PE „Roads of RS“ from Banja Luka. The road E-661 (M-16) extends in a north-south direction and it is one of the most important corridor in RS, which connects Banja Luka with Corridor X in the north in Croatia and with the Adriatic Sea in the south. The road E-661 also provides very important regional connection in the RS, Bosnia and Herzegovina (BiH).

The main goal of project is to improve traffic capacity and service levels on the north-south corridor in the RS by reconstructing the existing road M-16 Section II “Krupa – Bočac” which overlaps the part of the road section 189 of the main road M-16, from KM 22+546.50 to KM 35+427.66. The reconstruction of this section would increase level of service for road users.

Such development of road infrastructure in RS will contribute to significant investments in this part, so it will become one of the more competitive areas in the region of the Western Balkans. The development and construction of transport networks will significantly contribute to and influence the achievement of the goals of social, economic and overall functional development of the RS.

The main task of this multicriteria analysis is to evaluate all relevant criteria and to select the most suitable (appropriate) route. On the basis of a quantitative-qualitative analysis of various relevant characteristics of the variant solutions and the evaluation of the significance of these characteristics, the overall rating was done as well as the ranking of alignment variants. The assessment was done using the PROMETHEE method.

When selecting the criteria, the team took care to meet the economic, infrastructural and social goals of the project realization as well as environmental impact. Under the given circumstances, the criteria were chosen as to encompass and represent all relevant and available criteria that determine the main impacts.

In this context, 5 criteria groups were selected and further subdivided into 19 sub-criteria. Weighting values of individual criteria were calculated based on the significance and intensity of differences between individual criteria, as well as on the basis of previous research.

The individual evaluation of sub-criterion weight values was preceded by a joint consultation of the assessment team, which explained the multicriteria analysis procedure, presented the results of the variant analysis, and adopted the basic principles of weight assessment.

1.2. DESCRIPTION OF THE VARIANTS

Based on the analysis of planning documents of the republic and municipalities, as well as the analysis of spatial conditions with an emphasis on topographic, administrative, geo-political and economic conditions, the corridors of the future Krupa - Bočac route were selected.

The considered route is a result of the previous analysis and phases of the project. As a result of the previous phases of the project, variants 0, 3 and 4 are envisaged for further elaboration (Table 1).

Table 1. A comparative overview of the considered variants lengths

Variant	Variant „V0“	Variant „V3“	Variant „V4“
Length (m)	(L = 12,529 km)	(L = 12,505 km)	(L = 12,881 km)

VARIANT 0

The length of this Variant 0 is 12,529km. Variant 0 represents improvement of the existing road and have the same alignment as old road. This is completely suburban route.

VARIANT 3

The length of this Variant 3 is 12,504km which starts at KM 22+546.50 and ends at KM 35+051.31. This is completely suburban route.

The route of Variant 3 could be divided in three logical part in accordance of the type of intervention. First part is reconstruction of the existing main road through the settlement Krupa. This part is 3059.37 m long. The second part is completely new road by the river bed (on the right side of the river Vrbas). The length of this part is 5895 m. And finally, the third part represents the existing main road in length of 3550.44 m. For this part the route the reconstruction is predicted.

The route of the variant 3 is designed with the certain number of horizontal curves which are equal or bigger than predicted within ToR. The value of the grades is in the range between 0.5 and 1.5%.

VARIANT 4

The Variant 4 represents the route of the suburban road that passes by the settlements: Krmine, Agino Selo and Bočac. The length of this section is 12 881.16 m. The route starts at the station: KM 22 + 546.50, and ends at the station: KM 35 + 427.66. The major part of the terrain in which the route extends is hilly. The degree of restriction is significant and it is equal III. In accordance with the calculation speed ($V_r=70\text{km/h}$), the boundary elements are chosen.

From Krupsko polje at the beginning of the section on the elevation of 205 m above sea level, the route climbs to the zone of Krmine settlement, on the elevation of 380 m above sea level. After that, the route continues along the plateau towards the settlement Agino Selo. On this part of the route elevation is between 430 m and 480 m above sea level. After the passing of Agino Selo, the route starts to descend towards Bočac and the existing bridge over the river Vrbas. On this point altitude is 230 m above sea level.

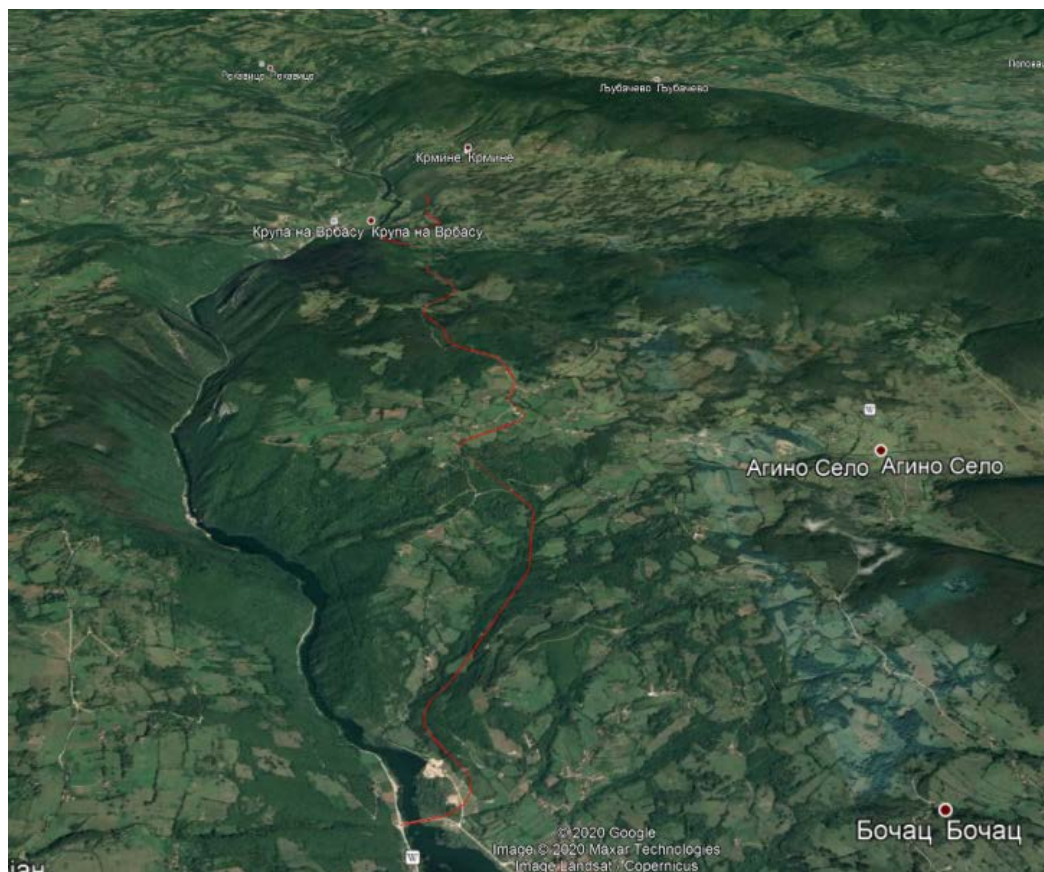

Figure 2. Alignment of the route 2a variants

2. METHODOLOGY

MCDA is often concerned with ranking a number of concrete alternatives from the best to the worst based on multiple criteria [1-2]. For example, Kuzovic et al. [3] applied the Multi-criteria analysis in evaluating of the road designs. Glavić et al. [4] used MCDA for cycling investment prioritization, while Milenkovic et al. [1] implemented MCDA for selecting the optimal road toll collection system. The PROMETHEE (Preference Ranking Organization Method for Enrichment Evaluations) method is one of the most recent (most current) MCDA methods developed by J.P. Brans in 1982 and further expanded (further upgraded) by Vincke and Brans [6]. PROMETHEE is an outranking method for a finite set of alternative actions (activities, procedures) that need to be ranked and selected among the criteria, which are often conflicting. PROMETHEE is also a fairly simple method of ranking in conception and application compared to other methods for multicriteria analysis [6].

The PROMETHEE family of methods, including PROMETHEE I for partial ranking of alternatives and PROMETHEE II for complete ranking of alternatives. The basic principle of PROMETHEE II is based on a comparison of pairs of alternatives for each selected criterion. The alternatives have been evaluated against different criteria, which must be maximised or minimised. The PROMETHEE II implementation requires two additional types of information: weighting coefficients and preference functions.

The procedure begins by determining the deviations based on pairwise comparisons (Equation 1). This is followed by the use of an appropriate preference function for each criterion in step 2 (Equation 2), the calculation of a general (comprehensive) preference index in step 3 (Equation 3), and the calculation of positive and negative flows (rankings) for each alternative, and a partial ranking in step 4 (Equation 4 and Equation 5). The process is completed by calculating the net flow (ranking) for each alternative and a complete ranking (Equation 6).

Step 1. Determining deviations (differences) based on pairwise comparisons

$$d_j(a, b) = g_j(a) - g_j(b) \quad (1)$$

Step 2. Application of preference function

$$P_j(\mathbf{a}, \mathbf{b}) = F_j[d_j(\mathbf{a}, \mathbf{b})] \quad j = 1, \dots, k \quad (2)$$

Step 3. Computation of a general preference index

$$\forall \mathbf{a}, \mathbf{b} \in A, \quad \pi(\mathbf{a}, \mathbf{b}) = \sum_{j=1}^k P_j(\mathbf{a}, \mathbf{b}) w_j \quad (3)$$

Step 4. Computation of flows/PROMETHEE 1 partial ranking.

$$\varphi^+(\mathbf{a}) = \frac{1}{n-1} \sum_{x \in A} \pi(\mathbf{a}, x) \quad (4)$$

$$\varphi^-(\mathbf{a}) = \frac{1}{n-1} \sum_{x \in A} \pi(x, \mathbf{a}) \quad (5)$$

Step 5. Computation of the total net flow /PROMETHEE II complete ranking

$$\varphi(\mathbf{a}) = \varphi^+(\mathbf{a}) - \varphi^-(\mathbf{a}) \quad (6)$$

2.1. DEFINITION OF LIST AND WEIGHTS OF CRITERIA'S

The MCDM analysis defined 19 indicators that are used to implement a procedure of selection of the planned Krupa – Bočac alternative routes. These 19 indicators were classified into the following 5 criteria groups.

1. Criteria group from the spatial and urbanistic aspect:
 - (1) Characteristics of variants from the aspect of expropriation and demolition of buildings and other structures/facilities;
 - (2) Characteristics of variants from the aspect of better traffic connection;
 - (3) Characteristics of variants from the aspect of relation to urban agglomerations (centres, cities and settlements);
2. Criteria group from the aspect of environmental protection and preservation:
 - (1) Characteristics of variants from the aspect of the impact of air pollution and noise emissions on the population;
 - (2) Characteristics of variants with regard to usurpation of agricultural and forest areas;
 - (3) Characteristics of variants with regard to the degradation of landscape, ambient and natural values;
3. Criteria group from the aspect of technical solutions:
 - (1) Length of road (km);
 - (2) Geological and hydrogeological conditions;
 - (3) Total share of structures in the alignment;
 - (4) Maximum slope of vertical alignment;
 - (5) Curvature characteristic;
 - (6) The complexity and duration of construction;
4. Characteristics from the traffic-exploitation aspect:
 - (1) Level of Service;
 - (2) Travel time;
 - (3) Road safety;
5. Criteria group from the economic aspect:
 - (1) Project implementation costs CapEx (€);
 - (2) Vehicle operating costs (€);
 - (3) Tunnel operating costs OpEx(€);
 - (4) Maintenance costs RepEx (€);

For the determination of the criteria weights MDL (Modified Digital Logic) method is applied. MDL method is based on the pairwise criteria comparison [7]. Decision makers use a scoring scheme with values {1, 2 and 3} to represent less significant (1), equally significant (2), or more significant (3) criteria. After all, pairwise comparisons, MDL weights are calculated as follows:

$$w_j = \frac{\sum_{k=1}^n C_{jk}}{\sum_{j=1}^n \sum_{k=1}^n C_{jk}}, \quad j \text{ and } k = \{1, \dots, n\}; j \neq k \quad (7)$$

2.2. FORMATION OF A MATRIX WITH SCORING AND WEIGHTING OF THE CRITERIA, AND PREFERENCES

The scoring for all 19 indicators were quantified by using the existing documentation for a number of indicators, as well as by doing adequate calculations, analyses and experts' assessment for other indicators.

Formation of a matrix with scoring and weighting of the criteria, and preference functions was done in PROMETHEE business edition software and given in table below.

Table 2. Matrices with scoring and weighting of the criteria, and Preference functions by alternative road solutions

Evaluations	Min/Max	Weight	Preference function	q	p	s	Variant 3	Variant 4	Variant 0
X11	min	4.00	V-shape	n/a	2.00	n/a	1.00	1.00	1.00
X12	max	4.00	V-shape	n/a	2.00	n/a	3.00	3.00	3.00
X13	max	4.00	V-shape	n/a	2.00	n/a	4.00	5.00	4.00
X21	min	4.00	V-shape	n/a	2.00	n/a	4.00	3.00	3.00
X22	min	4.00	V-shape	n/a	2.00	n/a	1.00	3.00	1.00
X23	min	5.00	V-shape	n/a	2.00	n/a	3.00	3.00	1.00
X31	min	6.00	V-shape	n/a	0.20	n/a	12.51	12.88	12.53
X32	max	4.00	V-shape	n/a	2.00	n/a	1.00	3.00	5.00
X33	min	4.00	V-shape	n/a	5.00	n/a	10.20	0.46	0.00
X34	min	4.00	V-shape	n/a	4.00	n/a	1.60	7.00	1.50
X35	min	4.00	V-shape	n/a	5.00	n/a	123.20	120.20	142.98
X36	min	5.00	V-shape	n/a	2.00	n/a	5.00	3.00	1.00
X41	max	5.00	V-shape	n/a	2.00	n/a	3.00	4.00	3.00
X42	min	5.00	V-shape	n/a	2.00	n/a	0.17	0.16	0.17
X43	max	7.00	V-shape	n/a	2.00	n/a	3.00	4.00	3.00
X51	min	8.00	V-shape	n/a	1000000	n/a	23400000	14014000	5530000
X52	min	7.00	V-shape	n/a	0.01	n/a	1.00	1.04	1.00
X53	min	7.00	V-shape	n/a	2.00	n/a	5.00	0.00	0.00
X54	min	7.00	V-shape	n/a	0.01	n/a	1.00	1.03	1.00

3. MCDM ANALYSIS RESULTS

3.1. PROMETHEE I AND II RANKING

There are two PROMETHEE rankings based on the calculation of preferential flows that are based on the calculation of preferential flows:

- PROMETHEE I Partial ranking
- PROMETHEE II Complete ranking

PROMETHEE II complete ranking means that all alternatives were compared and that ranking does not include a possibility of non-comparison when comparison is difficult. The result of ranking thus can be questionable, especially in the presence of strong conflicting criteria. Ranking is based on the net preferential flow. It combines two other preferential flows into one in the summary result. Thus, the alternative a has an advantage over the alternative b in PROMETHEE II ranking if and only if the advantage over b is based on the net preferential flow. In this specific case it is:

$$aP^{II}b \text{ if and only if } \Phi(a) > \Phi(b)$$

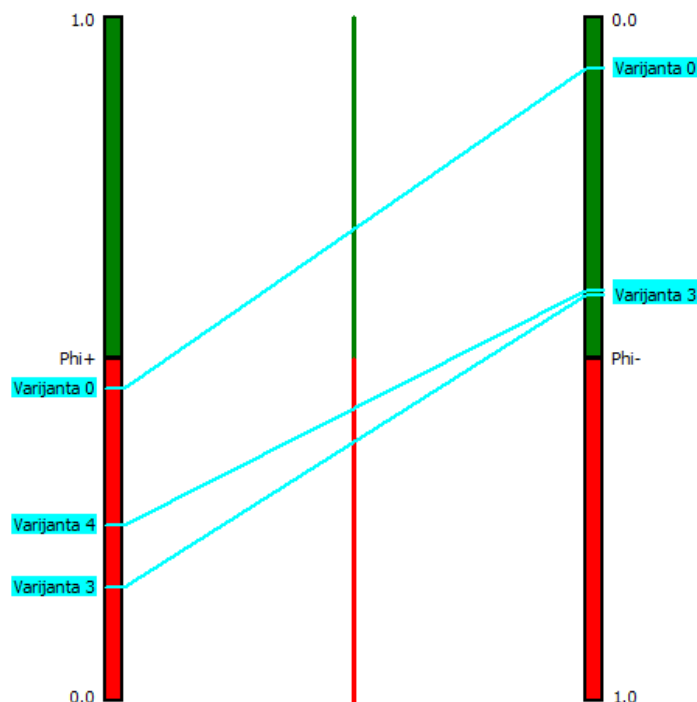

Figure 3. PROMETHEE I and II ranking

Based on the PROMETHEE I ranking given in figure 3 we can see that **Varijanta 0** is having advantage over variants C3 and V4 by both positive and negative flow.

Based on the PROMETHEE II ranking given in figure 3 we can see that **Varijanta 0** is the first ranked by the net flow.

PROMETHEE Table shows Phi, Phi+ and Phi- results. Alternatives are ranked according to the PROMETHEE II complete ranking.

Table 3. Ranking of alternatives by applying the Promethee model

Rank	Alternative	Phi	Phi +	Phi-
1	Varijanta 0	0.3812	0.4565	0.0753
2	Varijanta 4	-0.1423	0.2575	0.3998
3	Varijanta 3	-0.2389	0.1669	0.4058

According to the previously presented PROMETHEE rankings (Figure 3), as well as Table 3, the compromise ranking of variants for route 2a on the Krupa Boćac section is:

- Varijanta 0
- Varijanta 4
- Varijanta 3

3.2. SENSITIVITY ANALYSIS

Sensitivity analysis was conducted to see the stability of the results, and to give all the answers to possible variations of the individual weights of the criteria in the range from 0% to 100%, relative to the weights determined in this study.

In the graphs below, the horizontal dimension corresponds to the weight of the selected criterion, and the vertical dimension corresponds to Phi net flow. For each alternative, the line is drawn to show net flow as a function of the criterion weight. On the left and right edges of the figure, the criterion weight is 0% and 100%, respectively, and the alternatives are ranked according to that one criterion.

The position of the vertical green and red lines corresponds to the current weight of the criteria. The section of the action lines with the vertical line gives PROMETHEE II complete ranking. Two dashed vertical lines show the weight interval in which PROMETHEE II complete ranking remains unchanged (WSI - weight stability interval).

The figures below show a sensitivity analysis using stability intervals for all criteria.

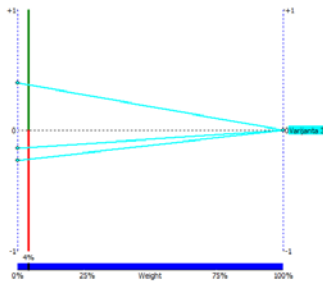

Figure 4. Sensitivity analysis for criteria expropriation and demolition of buildings and other structures/facilities

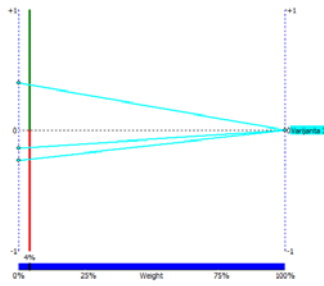

Figure 5. Sensitivity analysis for criteria better traffic connection

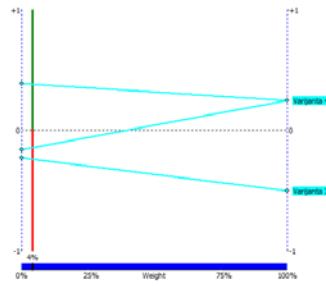

Figure 6. Sensitivity analysis for criteria relation to urban agglomerations (centres, cities and settlements)

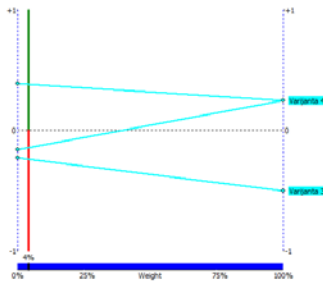

Figure 7. Sensitivity analysis for criteria impact of air pollution and noise emissions on the population

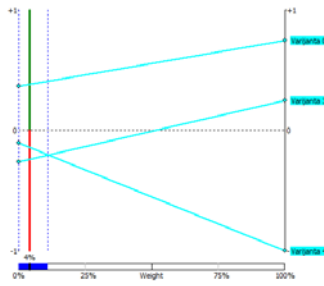

Figure 8. Sensitivity analysis for criteria usurpation of agricultural and forest areas

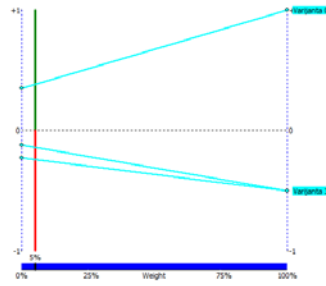

Figure 9. Sensitivity analysis for criteria degradation of landscape, ambient and natural values

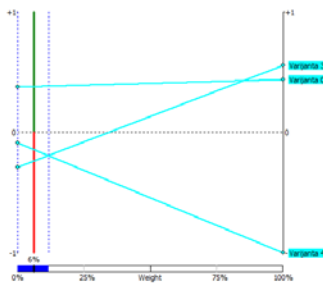

Figure 10. Sensitivity analysis for criteria road length

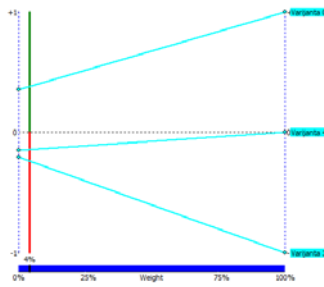

Figure 11. Sensitivity analysis for criteria geological and hydrogeological conditions

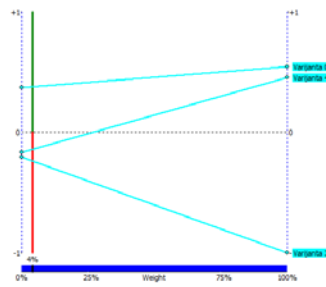

Figure 12. Sensitivity analysis for criteria total share of structures in the alignment

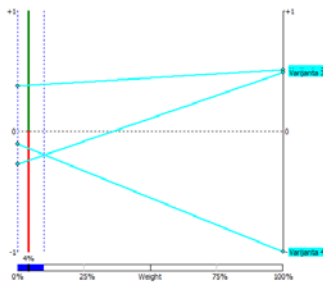

Figure 13. Sensitivity analysis for criteria maximum slope of vertical alignment

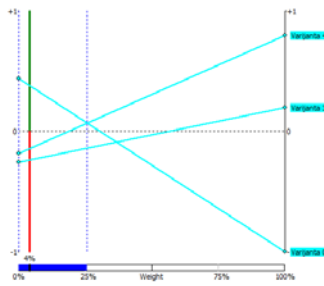

Figure 14. Sensitivity analysis for criteria curvature characteristics

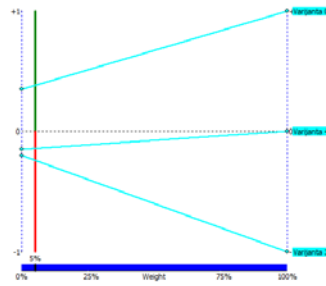

Figure 15. Sensitivity analysis for criteria complexity and duration of construction

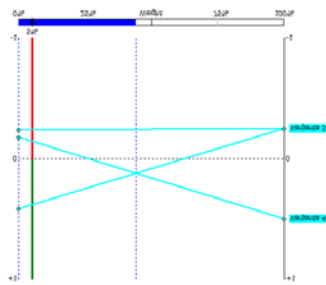

Figure 2. Sensitivity analysis for criteria level of service

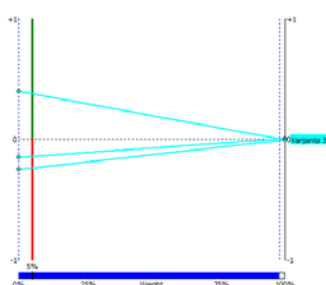

Figure 3. Sensitivity analysis for criteria travel time

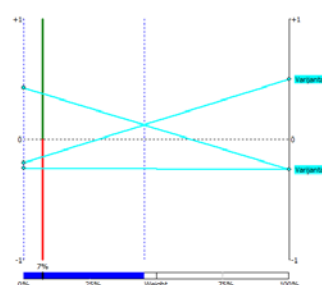

Figure 4. Sensitivity analysis for criteria traffic safety

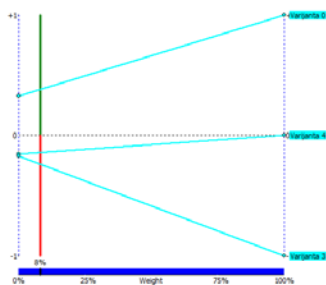

Figure 19. Sensitivity analysis for criteria project implementation costs

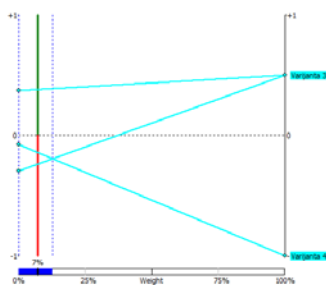

Figure 20. Sensitivity analysis for criteria vehicle operating costs

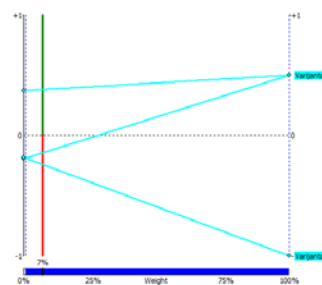

Figure 21. Sensitivity analysis for criteria tunnel operating costs

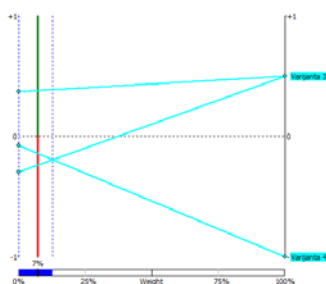

Figure 22. Sensitivity analysis for criteria maintenance costs

Sensitivity analysis presented on Figure 4 to 22 leads to a conclusion that the first ranked variant has very prominent stability according to all criteria, and one can conclude that the ranking is stable by most criteria.

4. DISCUSSION AND CONCLUSION

The previously performed analysis includes a detailed comparative analysis of all parameters that have an impact on the proposed alignment of route 2a on the section Krupa-Bočac. Based on the MCDM analysis using the PROMETHEE method according to the given list and weight of criteria, it can be concluded that variant 0 of the Krupa - Bočac section is the compromise first ranked variant. If we analyse preferential flows Φ , Φ^+ and Φ^- we can conclude that variant 0 is best solution according to all 3 flows, while variants 3 and 4 have negative Φ net flow and both V3 and V4 variants represent two least bad solutions. The main disadvantage of variant V3 is the high construction costs. The disadvantage of variant 4 is the high longitudinal grade.

Sensitivity analysis has shown that the first place has very prominent stability according to most criteria and that the first place is stable by most criteria. However, it is important to point out that the proposed compromise solution is based on defined weights of criteria. In other words, if there are significant changes in some criteria weights, there may be changes in the ranking.

Decision support framework presented in this paper can help future researchers and decision makers in solving similar problems of road alignment selection.

LITERATURE

- [1] M. Milenković, D. Glavić, and M. N. Mladenović, "Decision-Support Framework for Selecting the Optimal Road Toll Collection System," *J. Adv. Transp.*, vol. 2018, 2018, doi: 10.1155/2018/4949565.
- [2] D. Glavić, M. N. Mladenović, and M. Milenković, "Decision Support Framework for Cycling Investment Prioritization," *J. Adv. Transp.*, vol. 2019, 2019, doi: 10.1155/2019/7871426.
- [3] D. Glavić, *Komercijalna eksploatacija autoputeva: tehnologije naplate putarine*, 1st ed. Univerzitet u Beogradu, Saobraćajni fakultet, 2016.
- [4] L. Kuzović, D. Topolnik, and D. Glavić, "Induced traffic and its treatment in the evaluation of motorway projects," *Promet - Traffic - Traffico*, vol. 22, no. 6, 2010.
- [5] L. Kuzovic, B. Aleksic, and D. Glavic, "The application of the multi-criteria analysis in evaluating of the road designs," *Tehnika*, vol. 70, no. 1, pp. 143–150, 2015, doi: 10.5937/tehnika1501143k.
- [6] J. P. Brans, P. Vincke, and B. Mareschal, "How to select and how to rank projects: The Promethee method," *Eur. J. Oper. Res.*, vol. 24, no. 2, pp. 228–238, 1986, doi: 10.1016/0377-2217(86)90044-5.
- [7] A. Dehghan-Manshadi, M. R. Barnett, and P. D. Hodgson, "Microstructural evolution during hot deformation of duplex stainless steel," <https://doi.org/10.1179/174328407X239019>, vol. 23, no. 12, pp. 1478–1484, Dec. 2013, doi: 10.1179/174328407X239019.

09

Research paper I Оригинални научни рад
DOI 10.7251/STP2215083S
ISSN 2566-4484



Nevena Simić, University of Belgrade, nsimic@grf.bg.ac.rs
Predrag Petronijević, University of Belgrade, pecap@grf.bg.ac.rs
Aleksandar Devedžić, TX Services, aleksandar.devedzic93@gmail.com
Marija Ivanović, University of Belgrade, mapetrovic@grf.bg.ac.rs

PRELIMINARY QUANTITY ESTIMATION IN CONSTRUCTION USING MACHINE LEARNING METHODS

Abstract

This paper analyses the problem of estimating the required quantities of major work items in the construction of residential and residential-commercial buildings using machine learning algorithms. The goal is to form a model that will provide a fast and sufficiently accurate estimate of the quantities of major work items, based on a small amount of known information on the technical characteristics and the environment of future residential and residential-commercial buildings. The case study included 71 projects of residential and residential-commercial buildings construction realised on the territory of the Republic of Serbia. Several models have been developed, and the paper presents those models that had the best performances. The models developed in this way can significantly contribute to resource planning and the accuracy of cost estimates in the early project phases.

Keywords: quantity estimation, cost estimation, machine learning, artificial intelligence

ПРЕЛИМИНАРНА ПРОЦЕНА КОЛИЧИНА У ГРАЂЕВИНАРСТВУ ПРИМЕНОМ МЕТОДА МАШИНСКОГ УЧЕЊА

Сажетак

У овом раду је анализиран проблем предвиђања потребних количина главних радова код изградње стамбених и стамбено-пословних објеката коришћењем алгоритама машинског учења. Циљ је формирање модела који ће на основу малог броја познатих информација о техничким карактеристикама и окружењу будућих стамбених и стамбено-пословних објеката пружити брзу и довољно прецизну процену количина главних радова. Студија случаја је укључивала 71 пројекат изградње стамбених и стамбено-пословних објеката реализованих на територији Републике Србије. Развијен је већи број модела, а у раду су приказани они модели који су имали најбоље перформансе. Овако развијени модели могу значајно допринети планирању ресурса и тачности процена трошкова у раним пројектним фазама.

Кључне ријечи: процена количина, процена трошкова, машинско учење, вештачка интелигенција

1. INTRODUCTION

The construction industry in the Republic of Serbia has recorded significant growth in recent years, and this is mostly due to the increase in the number of residential and residential-commercial buildings that represent the dominant type in the field of building construction, both in the world and in our country. According to the data from the Statistical Office of the Republic of Serbia, the number of apartments built in the Republic of Serbia increased several times in the period from 2015 to 2020 (Figure 1) [1]. Since there has been a constant growth in this branch of construction in the last few years, the question is whether the process of quantities and cost planning in the early stages of project development can be improved and accelerated. Additionally, many investors who finance the construction of residential buildings do not have the technical knowledge in the field of construction to be able to plan their resources in the early stages of investment. Therefore, the question arises as to how this problem can be overcome.



Figure 1. Number of apartments built in the Republic of Serbia by years [1]

In addition to the construction industry, the area that has encountered substantial growth in the world in recent years is the development of artificial intelligence systems. The main goal of artificial intelligence is to develop a system that will solve a problem in an intelligent way. Such systems are suitable for application in areas where a large amount of data is available, and as construction is one of the areas in which each project consists of a multitude of data, the collaboration of artificial intelligence and the construction industry is completely justified. Artificial intelligence finds great application in overcoming numerous problems in construction project management [2] [3] [4] [5]. There are a number of cost estimation models developed using different methods of artificial intelligence. Two different terms can often be found in this field, namely artificial intelligence and machine learning. Machine learning is an area of artificial intelligence in which conclusions are based on previous experience.

Garcia de Soto et al. [6] developed a methodology for estimating material quantities in the early project stages using MRA, ANN, and CBR. The authors point out that the developed methodology can increase the accuracy of cost estimates and provide estimates in a shorter time. Beljkaš et al. [7] developed an ANN model that showed a high level of accuracy, with a mean absolute percentage error of 8.56% and 17.31% for concrete and reinforcement consumption, respectively. Chou et al. [8] developed a cost estimation system based on estimating the quantity of individual cost items in highway construction projects based on information known in the early project stages. The main objective for the quantity estimation on the item-level instead of estimating at the project level is to improve accuracy by separating unit prices from the quantity estimation. Quantity estimates have been developed for the major work items in the WBS. A statistical parametric model for quantities estimation was developed for each major work item. The developed models are integrated into the cost estimation model in order to estimate the costs of individual work items and the total costs of the project. Petroutsatou et al. [9] used neural networks to estimate the cost of tunnel construction. The development of the neural network model consisted of two steps. In the first step, the quantity of works is estimated, while in the second step, the final costs are estimated based on the quantities that are the result of the first step, and which now represent the input parameters. Models were developed using MLFN and GRNN. The application of GRNN gave better results in terms of model accuracy.

This paper analyses the problem of predicting the required quantities of major work items in the construction of residential and residential-commercial buildings by using machine learning algorithms. The goal is to form a model that will provide a fast and sufficiently accurate estimate of

the quantities of major work items based on a small amount of known information on the technical characteristics and the environment of future residential and residential-commercial buildings. Estimated work quantities can provide a preliminary cost estimate by multiplying them by corresponding unit prices and final summarising. This approach, which is based on a work breakdown structure, is more useful for decision makers because it can separate uncertainties related to quantities from uncertainties related to cost, but also uncertainties related to different types of work.

2. METHODOLOGY

The methodology of the work (Figure 2) consists of four phases:

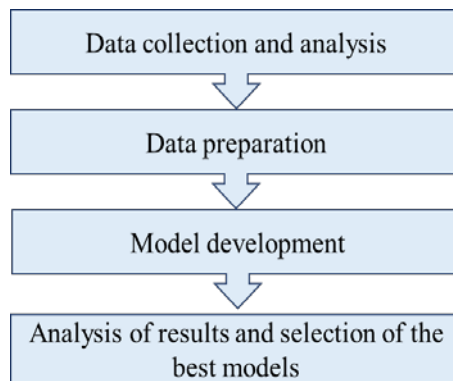

Figure 2. *Methodology of the model development*

3. DATA COLLECTION AND ANALYSIS

In the first phase, data on the realised projects for the construction of residential and residential-commercial buildings were collected. Data were collected by contacting contractors and design firms. The requested data included a technical description of a building, architectural design, and bill of quantities, and estimates of works. The total number of collected projects was 71, and the projects were implemented on the territory of the Republic of Serbia in the period from 2012 to 2020. In machine learning, the quality and size of the database are crucial for the success of prediction [10] so data collection was approached with special care.

After the data collection, there was an analysis of them and their limitations. The amount of data available in the early stages of project development is limited. For this reason, at the beginning of the research, the information and limitations available to the investor and the contractor in the early stages were analysed. These data represent the parameters on which the future cost and quantity estimates are based.

The first step in data processing is the analysis of the physical characteristics of the building such as the measures of the plot area, gross and net building area, and the vertical projection area of the building. The gross floor area ranges from 600 to 25,000 m², the number of underground floors ranges from 0 to 2 while the number of above-ground floors ranges from 2 to 9. Another parameter that has been taken into account is the population density in the area in which the building is situated. The population density parameter is classified into three categories: medium density, dense, and very dense. The buildings analysed have five different types of facades: plastered, demit, demit-stone, demit-ventilated, and aluminum facades. There are two types of slabs on the buildings: FERT system slabs and reinforced concrete slabs. As for the method of foundation, buildings differ in whether they are built on piles or without them. It was also taken into account whether a building has an underground garage or not.

Quantity data were analysed only for those types of works that have standardized units of measure, namely earthworks, concrete works, reinforcement works, ceramic tiles works, hardwood floor works, and insulation works. Quantities for earthworks and concrete works were calculated in cubic meters, quantities for ceramic tilework, hardwood, and insulation work in square meters, and quantities of reinforcement work in tons.

In machine learning, data that significantly deviates from the other data are called outliers and can be removed automatically using the algorithm called Isolation Forest, but in this case, the use of this algorithm is not necessary due to a small amount of data and projects representing outliers are

manually eliminated. Outliers can significantly influence the outcome of machine learning model training, so this step is extremely important for further work.

The physical characteristics of the building were analysed in more detail in order to see their distribution and identify possible extreme values. Projects with a gross floor area of more than 15,000 m² and a net floor area of more than 13,000 m² are extreme values in terms of the area measurements. Also, extreme values include projects whose plot area exceeds 4,000 m² and whose vertical projection exceeds 2,000 m². This data can affect the accuracy of the future model and is therefore eliminated.

After the elimination of outliers, the final number of projects for model development was 52.

4. DATA PREPARATION

4.1. INPUT AND OUTPUT VARIABLES IDENTIFICATION

The first step in creating a model is to define input (independent) and output (dependent) variables. The quantities of major works were adopted as the output variables. Parameters that define the location and technical characteristics of the building were adopted as input variables of the model. The input and output variables are shown in Table 1.

Table 1. Input and output variables

Input variables		Output variables
Object type	Number of above-ground floors	Earthworks quantity (m ³)
Plot area	Number of underground floors	Concrete works quantity (m ³)
Gross area of the building	Slab type	Reinforcement works quantity (t)
Net area of the building	Facade type	Ceramic tile works quantity (m ³)
Floor area	Vertical projection surface	Hardwood floor works quantity (m ³)
Occupancy of the plot	City	Insulation works quantity (m ³)
Foundation type	Density of population	
Underground garage		

4.2. CORRELATION ANALYSIS

For the successful development of a prediction model, it is of great importance to know the correlation between the input and output variables of a model, but also the correlation between different input variables. For this correlation to be described by an adequate mathematical function, it is necessary that the variables between which the correlation is described have numerical, not categorical values. Table 2 shows the correlation between certain variables that have numerical values. The higher the value in the table cell, the greater the correlation between the two quantities, i.e. as one measure increases, so does another one. Correlations between all examined variables have positive results, which means that with the increase of the area of the building or plot the quantities of works also increase.

Table 2. Correlation between input and output variables

	Plot area	Gross area of the building	Net area of the building	Floor area	Earthworks quantity	Quantity of concrete works	Reinforcement works quantity	Ceramic tileworks quantity	Hardwood floor works quantity	Insulation works quantity
Plot area	1	0,92	0,93	0,98	0,8	0,91	0,9	0,88	0,85	0,87
Gross area of the building	0,92	1	1	0,94	0,87	0,95	0,93	0,93	0,93	0,85
Net area of the building	0,93	1	1	0,94	0,88	0,95	0,94	0,92	0,93	0,86
Floor area	0,98	0,94	0,94	1	0,84	0,91	0,91	0,86	0,86	0,86
Earthworks quantity	0,8	0,87	0,88	0,84	1	0,88	0,88	0,78	0,74	0,73
Quantity of concrete works	0,91	0,95	0,95	0,91	0,88	1	0,95	0,9	0,86	0,85
Reinforcement works quantity	0,9	0,93	0,94	0,91	0,88	0,95	1	0,87	0,86	0,87
Ceramic tileworks quantity	0,88	0,93	0,92	0,86	0,78	0,9	0,87	1	0,89	0,89
Hardwood floor works quantity	0,85	0,93	0,93	0,86	0,74	0,86	0,86	0,89	1	0,85
Insulation works quantity	0,87	0,85	0,86	0,86	0,73	0,85	0,87	0,89	0,85	1

Figure 3 shows an example of the correlation between the input variables the gross area of the building and the area of the plot and the amount of earthworks.

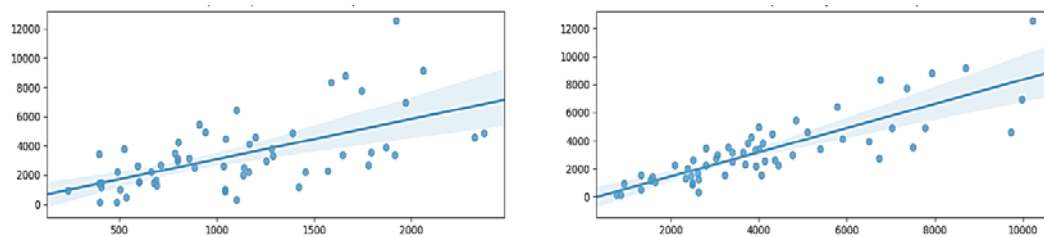

Figure 3. Correlation between the quantity of earthworks and: a) the plot area, b) the gross area of the building

4.3. ENCODING CATEGORICAL VARIABLES

Data such as the measures of the area or the number of floors are numerical data, so as such they can be passed directly to the model. However, data such as location, type of foundation, or façade type are categorical data, and as such must be encoded before being forwarded to the model.

Categorical data that has only two values, such as an underground garage (yes or no) or a type of foundation (with or without piles), can be easily encoded by replacing the category with a numeric value (1 or 0). However, data that contains more categorical values cannot simply be encoded with numbers because the question arises as to which value will get the higher score. In this case, the values of the categorical data are converted into columns, and the value of the data in the column corresponding to a certain categorical value will be 1, while in other columns representing the categorical values it will be 0 (Table 3).

Table 3. Encoding the categorical variables

Type of slab	Type of slab	Density of population	Medium-density	Dense	Very dense
RC	1	Medium-density	1	0	0
FERT	0	Dense	0	1	0
FERT	0	Very dense	0	0	1
RC	1	Dense	0	1	0
RC	1	Medium-density	1	0	0

4.4. FEATURE SCALING

The input parameters based on which the model will perform prediction can be quite different in terms of the size of numbers. Thus, for example, the parameter representing the number of above-ground floors ranges from 1 to 9, while the parameter representing the gross floor area of the building ranges up to 14,000. This difference in size can contribute to reducing the accuracy of the model, so the size of the input parameters must be scaled. Only numerical quantities are scaled, such as gross and net area, plot area, etc., and categorical quantities such as the type of facade are not scaled.

The most common types of data scaling are:

- standard scaling (scales sizes between -1 and 1 so that the average value is 0),
- robust scaling (scales sizes between two default values with eliminating outliers),
- normalisation (scales the sizes so that they tend to adapt to the normal distribution, i.e., Gaussian function),
- scaling between two quantities (scales sizes between two setpoints, usually 0 and 1).

In practice, there is no clearly defined instruction on which type of scaling to be used but in most cases, all four types of scaling are examined, which will be the case in this paper as well.

5. MODEL DEVELOPMENT

The total number of input parameters after encoding columns that contain categorical values is 15. Before the parameter values are passed to the model to begin model training, it is necessary to determine which combination of parameters will give the greatest accuracy. This problem is solved by iteration, which is automated using the Recursive Feature Elimination (RFE) function, and is available in the Scikit-Learn library, which is specialised in creating machine learning models.

The goal of RFE is to select the parameters that give the highest accuracy by recursively considering smaller and smaller sets of parameters. The model is first trained with one parameter from the set of all parameters and the accuracy of the model is determined through cross-validation. Then the number of parameters is increased and the combination of parameters that gives the highest accuracy of the model is sought. The disadvantage of this method is a large amount of time used due to numerous iterations. The number of input parameters that give the highest accuracy to the model varies from model to model.

The models were created and tested in the Python programming language with the help of the Scikit-Learn library, which specialises in machine learning, and the Keras library, which specialises in creating neural networks [11]. As it is not possible to know in advance which model will give the best performance, a total of 28 models were examined, so only those models that gave the best results will be considered in the following text. The following models were used (Table 4):

Table 4. Examined prediction models

1. Lasso Regression	15. K-Neighbors Regressor with K=2
2. Linear Regression	16. K-Neighbors Regressor with K=3
3. Passive Aggressive Regressor	17. K-Neighbors Regressor with K=5
4. Ridge Regression	18. K-Neighbors Regressor with K=7
5. SGD Regression	19. K-Neighbors Regressor with K=9
6. Decision Tree Regression	20. Ada Boost Regressor
7. Random Forest Regression	21. Ada Boost Regressor with Lasso
8. Support Vector Regression with linear kernel	22. Ada Boost Regressor with Linear Regression
9. Support Vector Regression with polynomial kernel	23. Ada Boost Regressor with Decision Tree Regression
10. Support Vector Regression with sigmoid kernel	24. Bagging Regressor with Extra Tree Regression
11. Support Vector Regression with RBF kernel	25. Bagging Regressor with Random Forest Regression
12. Extra Trees Regressor	26. Bagging Regressor with Lasso Regression
13. Gradient Boosting Regressor	27. Bagging Regressor with Linear Regression
14. K-Neighbors Regressor with K=1	28. Bagging Regressor with Decision Tree Regression

In addition to the above models, there was an examination of neural networks with a combination of different parameters such as:

- Number of hidden layers (between 2 and 8),
- Number of neurons (increased by 5 in the range up to 50-200),
- Type of activation function (ReLU, Softmax, and Tanh).

Finally, by comparing all the examined models of machine learning, both those that do not include neural networks and those that are based on neural networks, it can be concluded which models give the best results in terms of estimating the works quantities. The models that showed the best performance for estimating the required quantities are presented in Table 5.

Table 5. Quantity estimation models with the best performances

Required Quantity	Model	Activation Function	Type of scaling	Hidden layers	Number of neurons	Train Score	Test Score	MAPE (%)
Earthworks quantity	Neural Network	Relu	Standard Scaler	5	100	0.96	0.824	17,6
Concrete works quantity	Neural Network	Relu	Standard Scaler	5	150	0.927	0.883	11,7
Reinforcement works quantity	Neural Network	Relu	Standard Scaler	7	150	0.902	0.871	12,9
Ceramic tile works quantity	Neural Network	Relu	Standard Scaler	7	150	0.862	0.837	16,3
Hardwood floor works quantity	Neural Network	Relu	Standard Scaler	7	150	0.941	0.902	9,8
Insulation works quantity	K-Nearest Neighbors Regressor K=3	/	Robust Scaler	/	/	0.821	0.711	28,9

6. RESULTS AND DISCUSSION

By analysing the results, it can be concluded that the highest accuracy in estimating the required quantity of work was achieved by applying neural network models with the Relu activation function to estimate the quantity of earthworks, concrete, reinforcement, and hardwood works, while the use of classical models and neural networks achieved satisfactory accuracy in terms of predicting the quantity of ceramic and insulation works.

The evaluation of the accuracy of the models in this paper was examined by applying the measure MAPE for the mean absolute percentage error. MAPE is one of the most commonly used measures to assess the accuracy of the prediction [12] and has been used in a large number of studies related to the estimation of costs and quantities in construction (e.g. [13] [14] [15]). The mean absolute percentage error is defined by the following formula:

$$MAPE = \frac{1}{n} * \sum_{t=1}^n \left| \frac{A_t - F_t}{A_t} \right| * 100 \quad (1)$$

where A_t represents the actual value and F_t is the predicted value.

The quantities of individual works do not depend on the quality of works or on the fact whether subcontractors are engaged, but mostly on the type of construction, building area, number of floors, etc., so models for estimating the quantities can give good results in the early stages of planning. Cases in which the quantity decreases with increasing dimensions of the building is practically impossible, and a larger difference in the quantity of individual works for two buildings that are similar in area and number of floors can be attributed to different types of construction (e.g., RC slab and FERT slab). Very poor performance of the model for estimating the quantity of insulation works can be attributed to the fact that there are different types of insulation products so, due to the quality of materials in some cases, higher than average consumption is required. This is one of the rare types of work in which the quality of the material can significantly affect the required quantity.

7. CONCLUSION

Suggested models showed high levels of accuracy, with MAPE ranging from 9,8% to 28,9%. According to PMI (*Project Management Institut*) [16], the accuracy of cost estimates in early phases of project development ranges from -25% to +75%, while with project progress through life cycle phases accuracy increases and can range from -5% to +10%.

After all the results presented in this paper, the question arises as to how they can be improved. Based on the prediction of the proposed models, decision-making on starting the project implementation in the early stages of project development can be significantly accelerated and improved, and further improvement can improve future planning steps. The very principle of machine learning is based on learning from a large number of data based on which it is necessary to draw conclusions. To create the previously mentioned models, data from 52 construction projects were used, which represents a minimum amount of data in the field of machine learning, and especially in the field of neural networks (deep learning). In neural networks, unlike classical models, in most cases, there is an increase in accuracy with the increasing of the dataset, so it can be concluded that increasing the number of projects would contribute to improving the performance of created models.

The source of data for creating the model in this research was the technical description and bill of quantities and estimates of works but they provide a limited amount of data. In order to get a realistic insight into the quantities of works, instead of data from bill of quantities and estimates, it is necessary to use data from the project of the constructed object. The bill of quantities and estimates of work is an assessment, which in itself carries a certain level of error, while the project of the constructed object contains actual data on the quantities and money spent, and as such is a much more relevant source of information.

Finally, it must be mentioned that the data for 52 objects based on which the analysis was performed were collected from more than 40 companies, which represents a big problem in terms of creating models due to high variability. Each design firm has its own design style but the project itself dictates the way the work is performed and that can lead to poorer model performance, especially if there is a small amount of data. If the predictions were made based on more than 500 projects carried out by 20 to 30 companies, the fact which company performed them would significantly affect the result. However, as there is no universal model that would have good performance for all types of projects,

the best performance of a model would be achieved if the model were created only based on the data provided by one company, i.e., if the model were made specifically for a particular company. This can substantially limit the application of such a system, especially in the Republic of Serbia, because the number of companies that have built more than 50 residential or residential-commercial buildings (which were the subject of research) is very small.

LITERATURE

- [1] The Statistical Office of the Republic of Serbia, "The number of completed appartments per year in the Republic of Serbia," 2022. [Online]. Available: <https://www.stat.gov.rs/oblasti/gradjevinarstvo/stanovi/>. [Accessed: 25-Feb-2022].
- [2] Y. Pan and L. Zhang, "Roles of artificial intelligence in construction engineering and management: A critical review and future trends," *Autom. Constr.*, vol. 122, no. November 2020, p. 103517, 2021.
- [3] W. Eber, "Potentials of artificial intelligence in construction management," *Organ. Technol. Manag. Constr.*, vol. 12, no. 1, pp. 2053–2063, 2020.
- [4] M. Kovacevic, N. Ivanišević, P. Petronijević, and V. Despotovic, "Construction cost estimation of reinforced and prestressed concrete bridges using machine learning," *Gradjevinar*, vol. 73, no. 1, pp. 1–13, 2021.
- [5] I. Peško *et al.*, "Estimation of Costs and Durations of Construction of Urban Roads Using ANN and SVM," *Complexity*, vol. 2017, 2017.
- [6] B. García de Soto, B. T. Adey, and D. Fernando, "A hybrid methodology to estimate construction material quantities at an early project phase," *Int. J. Constr. Manag.*, vol. 17, no. 3, pp. 165–196, 2017.
- [7] Ž. Beljkaš, M. Knežević, S. Rutešić, and N. Ivanišević, "Application of Artificial Intelligence for the Estimation of Concrete and Reinforcement Consumption in the Construction of Integral Bridges," *Adv. Civ. Eng.*, vol. 2020, 2020.
- [8] J. Chou, M. Peng, K. R. Persad, and J. T. O. Connor, "Quantity-Based Approach to Preliminary Cost Estimates for Highway Projects," no. December, 2006.
- [9] K. Petroutsatou, E. Georgopoulos, S. Lambropoulos, and J. P. Pantouvakis, "Early Cost Estimating of Road Tunnel Construction Using Neural Networks," *J. Constr. Eng. Manag.*, vol. 138, no. 6, pp. 679–687, 2012.
- [10] M. Mohri, A. Rostamizadeh, and A. Talwalker, *Machine learning*, vol. 0. Cambridge, Massachusetts: The MIT Press, 2012.
- [11] S. Raschka and V. Mirjalili, *Python Machine Learning - Machine Learning and Deep Learning with Python, scikit-learn, and TensorFlow*, 2nd editio., vol. 69, no. 4. Birmingham UK: Packt Publishing Ltd., 2017.
- [12] S. Kim and H. Kim, "A new metric of absolute percentage error for intermittent demand forecasts," *Int. J. Forecast.*, vol. 32, no. 3, pp. 669–679, 2016.
- [13] K. Tijanić, D. Car-Pušić, and M. Šperac, "Cost estimation in road construction using artificial neural network," *Neural Comput. Appl.*, vol. 0123456789, pp. 9343–9355, 2020.
- [14] M. Li, M. Baek, and B. Ashuri, "Forecasting Ratio of Low Bid to Owner's Estimate for Highway Construction," *J. Constr. Eng. Manag.*, vol. 147, no. 1, p. 04020157, 2021.
- [15] B. J. Gardner, D. D. Gransberg, M. Asce, and J. A. Rueda, "Stochastic Conceptual Cost Estimating of Highway Projects to Communicate Uncertainty Using Bootstrap Sampling," *J. Constr. Eng. Manag.*, pp. 1–9, 2017.
- [16] PMI, *A guide to the project management body of knowledge (PMBOK guide)*. Project Management Institut, 2017.



Dragan Milašinović, University of Novi Sad, ddmilasinovic@gmail.com
Danica Goleš, University of Novi Sad, dgoles@gmail.com
Andrea Rožnjik, University of Novi Sad, andrea@gf.uns.ac.rs
Nataša Mrđa Bošnjak, University of Banja Luka, natasa.mrdja-bosnjak@aggf.unibl.org

MODEL OF POROUS MATERIALS BY RHEOLOGICAL-DYNAMICAL ANALOGY USING THE PRINCIPLES OF MASS AND ENERGY CONSERVATION

Abstract

It is assumed that the porous material is based on the principle of conservation of mass and the principle of conservation of energy. The validity of both principles relies on experimental observations. Experimental results of different metals were used to compare the Poisson ratio as a function of porosity. A comparison is made between the theory of percolation and the model proposed in this paper based on the rheological-dynamic analogy (RDA). The results show that there is an excellent agreement between percolation theory and the RDA model. Finally, a new relationship between the creep coefficient and porosity was proved for all analyzed metals by defining their damage variable in the range of measurable porosities.

Keywords: Porous materials; Mass and energy conservation; Percolation theory; RDA model, Metals.

МОДЕЛ ПОРОЗНИХ МАТЕРИЈАЛА РЕОЛОШКО-ДИНАМИЧКОМ АНАЛОГИЈОМ ПРИМЕНОМ ПРИНЦИПА ОЧУВАЊА МАСЕ И ЕНЕРГИЈЕ

Сажетак

Претпоставља се да је порозни материјал заснован на принципима очувања масе и енергије. Ваљаност оба принципа се заснива на експерименталним запажањима. Експериментални резултати различитих метала коришћени су за поређење Поасоновог коефицијента као функције од порозности. Упоредјена је теорија перколације са моделом предложеним у овом раду који се заснива на реолошко-динамичкој аналогји (РДА). Резултати показују да постоји одлично слагање између теорије перколације и РДА модела. Коначно, доказана је нова веза између коефицијента течења и порозности за све анализиране метале дефинисањем њихове варијабле оштећења у опсегу мерљивих порозности.

Кључне ријечи: Порозни материјали; Очување масе и енергије; Теорија перколације; РДА модел, Метали.

1. INTRODUCTION

So far, significant work has been done to connect the mechanical properties of the material with its microstructure. In particular, relationships have been established between porosity and key mechanical properties such as strength and modulus of elasticity. However, the usefulness and physical significance of many of these relationships are often unclear as most theoretical models are based on some idealized physical microstructure, and the resulting correlations often cannot be applied to actual materials and practical applications, [1].

Spriggs' empirical equation for Young's modulus of porous materials [2], and the similar Ryshkewitch-Duckworth equation for the strength of porous materials [3], have long been accepted from the literature. Also, Phani and Niyogi derived a semi-empirical equation to describe the porosity dependence of Young's modulus of brittle solids [4]. Further, Wang theoretically obtained the relationship between porosity and Young's modulus for porous materials made by powder metallurgy, [5]. The dependence is applicable to the entire range of porosity and is able to treat the transition of the pore structure from interconnected to isolated. However, later, advances in predicting the elastic properties of porous materials over the entire porosity range were closely related to the semi-empirical relationship to Phani and Niyogi, [4].

Porous metals are preferably prepared from powder, the size, and shape of which can vary considerably. During powder consolidation, different porosities can be achieved by varying technological parameters such as temperature, external pressure, or time. Compaction begins only by touching the powder particles and goes to a lower porosity by creating and growing a throat between the particles. Subsequent closure of the pore channels leads to the elimination of the pores. Analyzing these metallic materials, Kovačik concluded that the Phani-Niyogi equation is identical to the equation of percolation theory for Young's behavior and the shear modulus with porosity, [6]. Kovačik determined the percolation threshold for porosity at which the effective Young and the shear modulus become zero. However, the theory of percolation is beyond the content of this paper. This paper only uses the results presented by Kovačik [7] for comparison with the results of the RDA model.

The topic of this paper is related to the RDA model. Taking into account the RDA, the rheological behavior of the sample can be characterized by only one parameter, i.e., the dynamic time of retardation $T^D = 1/\omega$, where ω is the natural angular frequency of the discrete dynamic model. The RDA model has the same phase angle as the discrete dynamic model with damping in the steady state vibration, so from that fact the coefficient of viscous damping was obtained by Milašinović, [8]. Milašinović has already explained the RDA model of material behavior for axially cyclically loaded bars on a macro scale in order to predict their fatigue behavior, [9]. The efficient numerical implementation of RDA and its practical application was also studied by Milašinović for the visco-elasto-plastic behavior of metallic bars where the load function for the Hencky theory is derived, [10]. The main goal of this paper is to predict the relationship between creep coefficient and porosity of materials. It is considered that the principle of conservation of mass and energy is valid during the wave movement between two cross-sections of the sample, regardless of how the bar material behaves in terms of size and arrangement of material particles.

2. POISSON RATIO OF POROUS MATERIALS USING RHEOLOGICAL-DYNAMICAL ANALOGY

Mechanical disturbance (deformation) propagates in an elastic sample at phase velocity v_0 . Thus, the deformations, which are initiated at the moment t_0 of the wave source, reach an arbitrary point M of the sample at the moment t_1 . The larger the path l of the wave that travels from its source to the point M , the greater the difference $t_1 - t_0$. Accordingly, the vibration at the point M lags behind that at the source of the wave. If l_0 is the distance between the two ends of the sample, follows

$$T^D = t_1 - t_0 = \frac{l_0}{v_0}. \quad (1)$$

During a small time interval T^D the total strain energy density will move so that the fictitious area A_1 of the cross section 1 will have moved a short distance Δl_1 . In the same time the cross section area A_2 will have moved a greater distance Δl_2 such that

$$A_1 \Delta l_1 = A_2 \Delta l_2 = V, \quad (2)$$

where V is the fictitious volume.

Energy has passed through a fictitious volume without physically transferring material from the source by any cross section in time T^D . Thus, the continuity equation derives from the principle of mass conservation

$$A_1 v_1 = A_2 v_2, \quad (3)$$

where v_1 and v_2 are the velocities.

Therefore,

$$v_2 = \frac{A_1}{A_2} v_1. \quad (4)$$

The energy equation is the result of applying the principle of energy conservation to a stable energy transfer. Thus, the reduced area A_2 can now be found by applying Bernoulli's energy theorem

$$\sigma_1 + \frac{1}{2} \rho v_1^2 = \sigma_2 + \frac{1}{2} \rho v_2^2, \quad (5)$$

where σ_1 and σ_2 are the stresses and ρ is the mass density.

Due to (4), equation (5) becomes

$$\sigma_1 + \frac{1}{2} \rho v_1^2 = \sigma_2 + \frac{1}{2} \rho \left(\frac{A_1}{A_2} \right)^2 v_1^2. \quad (6)$$

Since the velocity v_1 is the phase velocity

$$v_1 = v_0 = \sqrt{\frac{E_H}{\rho}}, \quad (7)$$

where E_H is the Young modulus, (6) and (7) imply

$$A_2 = \frac{A_1}{\sqrt{\frac{2(\sigma_1 - \sigma_2)}{E_H} + 1}}}, \quad (8)$$

where $\sigma_1 = \sigma_E$ is the elastic stress.

2.1. RELATIONSHIP BETWEEN POISSON RATIO AND CREEP COEFFICIENT

Milašinović, [9], defined the endurance limit $\sigma_e(R)$, where the ratio of minimum and maximum stress is R . In the symmetrical cycle ($R = -1$) follows

$$\sigma_2 = \sigma_e(R) = \frac{\sigma_1}{1 + \varphi^*}, \quad (9)$$

where φ^* is the structural-material creep coefficient. Taking $\sigma_2 = \sigma_e(R)$, the reduced area A_2 is

$$A_2 = \frac{A_1}{\sqrt{\frac{2\sigma_E}{E_H} \left(\frac{\varphi^*}{1 + \varphi^*} \right) + 1}}}. \quad (10)$$

Experiments show that under tension, the length of the cylindrical sample increases by Δl , while its diameter Φ_1 decreases. Longitudinal strain can be found by applying Hooke's law

$$\varepsilon_l = \frac{\sigma_E}{E_H}. \quad (11)$$

If the bar is subjected to tensile or compressive stress in a given direction, not only strain occurs in that direction (longitudinal strain), but also strains in directions perpendicular to it (transverse strains). Within the range of elastic action, the relationship between transverse and longitudinal strain under uniaxial loading conditions is called the Poisson ratio. The transverse strain is

$$\varepsilon_t = \mu_0^* \varepsilon_l, \quad (12)$$

where μ_0^* is Poisson's ratio of solid material.

On the other hand the transverse strain is

$$\varepsilon_t = \frac{\Phi_1 - \Phi_2}{\Phi_1}. \quad (13)$$

Φ_1 is the sample diameter while Φ_2 is the reduced diameter.

Hence,

$$\mu_0^* = \frac{\Phi_1 - \Phi_2}{\Phi_1} \frac{E_H}{\sigma_E}. \quad (14)$$

The reduced sample diameter Φ_2 for all $0 < \varphi < \varphi^*$ can be obtained using equation(10),

$$\Phi_2 = \frac{\Phi_1}{\sqrt[4]{\frac{2\sigma_E}{E_H} \left(\frac{\varphi}{1+\varphi} \right) + 1}}, \quad (15)$$

so the relationship between the Poisson's ratio and the creep coefficient is

$$\mu(\varphi) = \left[1 - \frac{1}{\sqrt[4]{\frac{2\sigma_E}{E_H} \left(\frac{\varphi}{1+\varphi} \right) + 1}} \right] \frac{E_H}{\sigma_E}. \quad (16)$$

The assumption of incompressibility is supported by the fact that the bulk modulus is three orders of magnitude larger than the shear modulus. As a result, compressibility can significantly affect the stress distribution, especially when the Poisson ratio, i.e., μ_0^* approaches 0.5. Generally speaking, it is difficult to experimentally determine the bulk modulus, and only a few special experiments can be found in the literature. For most structural materials, the Poisson ratio has values ranging from one-third to one-fifth; therefore, with ordinary measuring devices, the accuracy of lateral deformation measurements is not as high as with the corresponding axial strain measurements. This discussion of the relationship between variables shows that we can also use E_H and μ_0^* as constants and get the following expression for the creep coefficient φ , which is a new characteristic of the strain state

$$\varphi(\mu) = \left[\left(\frac{1}{1 - \frac{\mu\sigma_E}{E_H}} \right)^4 - 1 \right] \frac{E_H}{2\sigma_E} / \left\{ 1 - \left[\left(\frac{1}{1 - \frac{\mu\sigma_E}{E_H}} \right)^4 - 1 \right] \frac{E_H}{2\sigma_E} \right\}. \quad (17)$$

The function $\varphi(\mu)$ is shown in Figure 1.

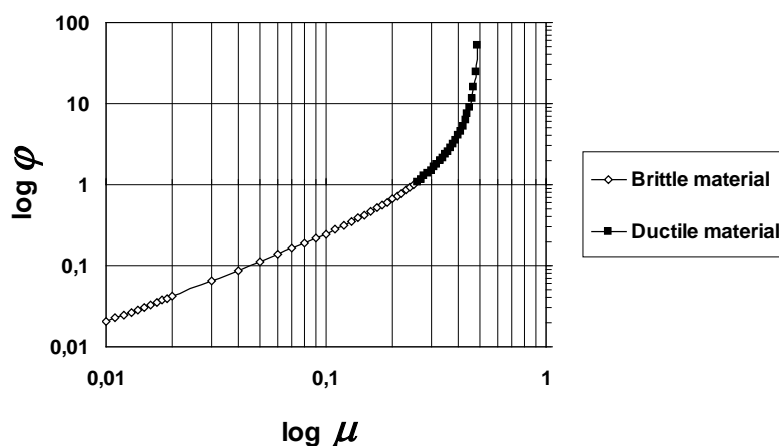

Figure 1. Creep coefficient versus Poisson's ratio

The general approach to the analysis of the problem of the influence of the Poisson's ratio on the development of the creep coefficient must be based on Eq.(17). Assuming that, at the limit of elasticity $\sigma_E/E_H = 0.001$, it follows

$$\varphi(\mu) = \left[\left(\frac{1}{1-0.001\mu} \right)^4 - 1 \right] \frac{1}{2 \cdot 0.001} \left/ \left\{ 1 - \left[\left(\frac{1}{1-0.001\mu} \right)^4 - 1 \right] \frac{1}{2 \cdot 0.001} \right\} \right. \quad (18)$$

Assuming that μ_0^* is 1/3 for metals, we get $\varphi^* = 2$. The semi-brittle material is determined by the linear dependence of $\log \varphi$ on $\log \mu$, as shown in Figure 1. According to this criterion, the upper limit value of the Poisson's ratio for semi-brittle materials is 0.25.

The relationship given by Eq.(18) can be simplified by neglecting the products of second-order exponents, [11]:

$$\begin{aligned} & \left[\left(\frac{1}{1-0.001\mu} \right)^4 - 1 \right] \frac{1}{2 \cdot 0.001} = \\ & \left\{ \frac{1}{\left[1 - 0.002\mu + (0.001\mu)^2 \right] \left[1 - 0.002\mu + (0.001\mu)^2 \right]} - 1 \right\} \frac{1}{0.002} \approx \\ & \left[\frac{1}{(1-0.002\mu)(1-0.002\mu)} - 1 \right] \frac{1}{0.002} = \left[\frac{1}{1-0.004\mu + (0.002\mu)^2} - 1 \right] \frac{1}{0.002} \approx \\ & \left(\frac{1}{1-0.004\mu} - 1 \right) \frac{1}{0.002} = \left(\frac{0.004\mu}{1-0.004\mu} \right) \frac{1}{0.002} = \frac{2\mu}{1-0.004\mu} \approx 2\mu \end{aligned} \quad (19)$$

so the relationship between the creep coefficient and the Poisson's ratio is

$$\varphi = \frac{2\mu}{1-2\mu} \quad (20)$$

If the creep coefficient is a known value, follows

$$\mu = \frac{\varphi}{2(1+\varphi)} \quad (21)$$

2.2. RELATIONSHIP BETWEEN CREEP COEFFICIENT AND POROSITY

Creep can occur in metals, plastics, rubber, glass, concrete and many other materials. Copper, iron, nickel and their alloys will exhibit creep at high temperatures. When a constant force is applied, some materials gradually deform over time and the result is an increase in length. However, in the

study of material fatigue [9], a very short time T^D was used (T^D represents the time delay that a wave of velocity v_0 takes to traverse the length l_0), due to which the creep coefficient was converted into a quotient of two modules

$$\varphi^* = \frac{E_H}{E_K}, \quad (22)$$

where E_K is the modulus of viscoelasticity. The creep coefficient is a linear function of both p and E_H , while E_K is independent of porosity and constant of the material, as a consequence of the principle of mass conservation. Figure 2 shows the linear dependence of the creep coefficient on the porosity. φ^* is the creep coefficient at zero porosity while φ_E is the creep coefficient at the end of the porosity range p_E . p_E is a known value as well as p_{max} , which is defined at zero creep coefficient. Considering the points $(0, \varphi^*)$ and (p_E, φ_E) , the linear dependence can be expressed by

$$\varphi(p) = \varphi^* - \frac{p(\varphi^* - \varphi_E)}{p_E}. \quad (23)$$

On the other hand, due to points (p_E, φ_E) and $(p_{max}, 0)$, the linear dependence is

$$\varphi(p) = \varphi^* \left(1 - \frac{p}{p_{max}}\right). \quad (24)$$

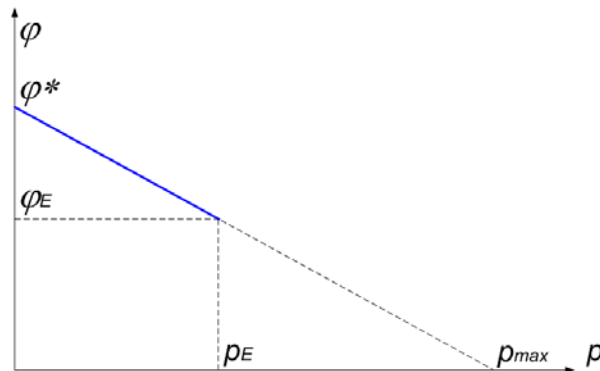

Figure 2. Creep coefficient versus porosity

2.3. POISSON RATIO OF POROUS MATERIALS

The relationship between the Poisson ratio and the porosity follows on the basis of Eq.(21)

$$\mu_{RDA}(p) = \left[\varphi^* - \frac{p(\varphi^* - \varphi_E)}{p_E} \right] / \left\{ 2 \left[1 + \varphi^* - \frac{p(\varphi^* - \varphi_E)}{p_E} \right] \right\}, \quad (25)$$

where

$$\varphi^* = \frac{2\mu_0^*}{1 - 2\mu_0^*}. \quad (26)$$

μ_0^* is the measured value.

The creep coefficient of the porous material at the end of the porosity range p_E is

$$\varphi_E = \frac{2\mu_E}{1 - 2\mu_E}, \quad (27)$$

where μ_E must be defined.

2.4. CRITICAL DAMAGE VARIABLE OF POROUS MATERIALS

Since the development of micro voids leads to a decrease in the stiffness of the material, Milašinović characterized the state of damage of isotropic materials with a critical scalar damage variable, [11], Figure 3.

$$D = \frac{\varphi}{1 + \varphi}, \quad (28)$$

where $0 \leq D \leq 1$.

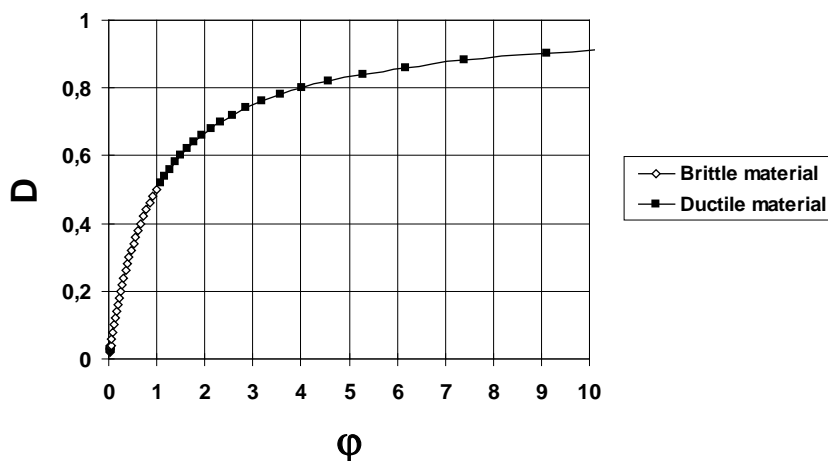

Figure 3. Critical damage variable versus creep coefficient

In the case of porous materials, follows

$$D(p) = \left[\varphi^* - \frac{p(\varphi^* - \varphi_E)}{p_E} \right] / \left\{ 1 + \left[\varphi^* - \frac{p(\varphi^* - \varphi_E)}{p_E} \right] \right\}. \quad (29)$$

Mot and Rondal, [12], found that all actual materials have a Poisson ratio between 0.2 and 0.5, so for these boundaries are $0.66 \leq \varphi \leq \infty$ and $0.4 \leq D \leq 1$. The critical state of elastic parameters of brittle elastic solids containing slits-critical, was also investigated by Krajčinović et al., [13]. According to Lemaitre, [14], the critical value of the damage variable corresponds to the breaking of elements into two parts, where $0.2 \leq D \leq 0.8$ is for metals. According to the RDA model, the critical damage variable for porous materials in the porosity range $0 \leq p \leq p_E$ is

$$\frac{\varphi^*}{1 + \varphi^*} \geq D \geq \frac{\varphi_E}{1 + \varphi_E}. \quad (30)$$

3. POISSON RATIO OF POROUS MATERIALS USING PERCOLATION THEORY

Phani and Niyogi have developed the power exponent correlation for describing the dependence of Young's modulus and porosity of brittle solids [4]

$$E = E_0(1 - ap)^n, \quad (31)$$

where E and E_0 are the Young's moduli at porosity p and zero, respectively, a and n are material constants. The expression has been derived semi-empirically for describing the porosity dependence of Young's modulus of brittle solids. The equation satisfies quite well the exact theoretical solution for the values of Young's moduli at different porosities for model systems with ideal and non-ideal

packing geometry, where parameters a and n provide information about the packing geometry and pore structure of the material.

According to [6] and [15], Eq.(31) is identical with the percolation theory equation for the behavior of Young's and shear modulus with porosity:

$$E = E_0 \left(1 - \frac{P}{p_{max}}\right)^{f_E} \quad \text{for } p \leq p_{max}, \quad (32)$$

$$G = G_0 \left(1 - \frac{P}{p_{max}}\right)^{f_G} \quad \text{for } p \leq p_{max}, \quad (33)$$

where f_E is the characteristic exponent for the Young's modulus while f_G is the characteristic exponent for the shear modulus of the porous material.

p_{max} is the percolation threshold [16], i.e. the porosity at which the effective Young's E and shear modulus G become zero. From Eq.(22) it follows that $\varphi(p_{max})$ is zero when $E(p_{max})$ is zero, which means that the adopted percolation threshold p_{max} also corresponds to the RDA model.

After substituting Eqs. (32) and (33) in the equation

$$\mu = \frac{E}{2G} - 1, \quad (34)$$

the correlation between Poisson's ratio and porosity from the percolation theory was obtained by Kovačik in [7] as

$$\mu_{PT}(p) = (\mu_0^* + 1) \left(1 - \frac{P}{p_{max}}\right)^{f_E - f_G} - 1, \quad (35)$$

where

$$\mu_0^* = \frac{E_0}{2G_0} - 1. \quad (36)$$

Poisson's ratio μ_0^* of solid material corresponds to the calculated value using the velocities of P and S waves, [17].

4. MODEL VERIFICATION AND DISCUSSION

A systematic study of the variation of elastic moduli and Poisson's ratio of sintered iron compacts of porosity up to 21.6% has been carried out by measuring longitudinal and shear ultrasonic velocities, [18]. The variation of these parameters with porosity was compared with predictions of elasticity and scattering theories. Using these results, Kovačik [7] presented the results of the correlation of Poisson's ratio and porosity by percolation theory.

According to Table I from [7], for sintered iron are:

$$\mu_0^* = 0.303, \quad p_{max} = 0.41, \quad p_E = 0.22, \quad f_E - f_G = 0.09.$$

Hence,

$$\mu_{PT}(0) = \mu_0^* = 0.303,$$

$$\mu_{PT}(p_E) = (\mu_0^* + 1) \left(1 - \frac{p_E}{p_{max}}\right)^{f_E - f_G} - 1 = (0.303 + 1) \left(1 - \frac{0.22}{0.41}\right)^{0.09} - 1 = 0.21585.$$

According to the RDA model are:

$$\varphi^* = \frac{2\mu_0^*}{1 - 2\mu_0^*} = \frac{2 \cdot 0.303}{1 - 2 \cdot 0.303} = 1.53807,$$

$$\varphi_E = \frac{2\mu_{PT}(p_E)}{1 - 2\mu_{PT}(p_E)} = \frac{2 \cdot 0.21585}{1 - 2 \cdot 0.21585} = 0.75965.$$

Hence,

$$\mu_{RDA}(0) = \frac{\varphi^*}{2(1+\varphi^*)} = \mu_0^* = 0.303,$$

$$\mu_{RDA}(p_E) = \frac{\varphi_E}{2(1+\varphi_E)} = \frac{0.75965}{2(1+0.75965)} = 0.21585 = \mu_{PT}(p_E).$$

Figure 4 shows the comparison between the percolation theory and the RDA model in the analyzed porosity range for sintered iron.

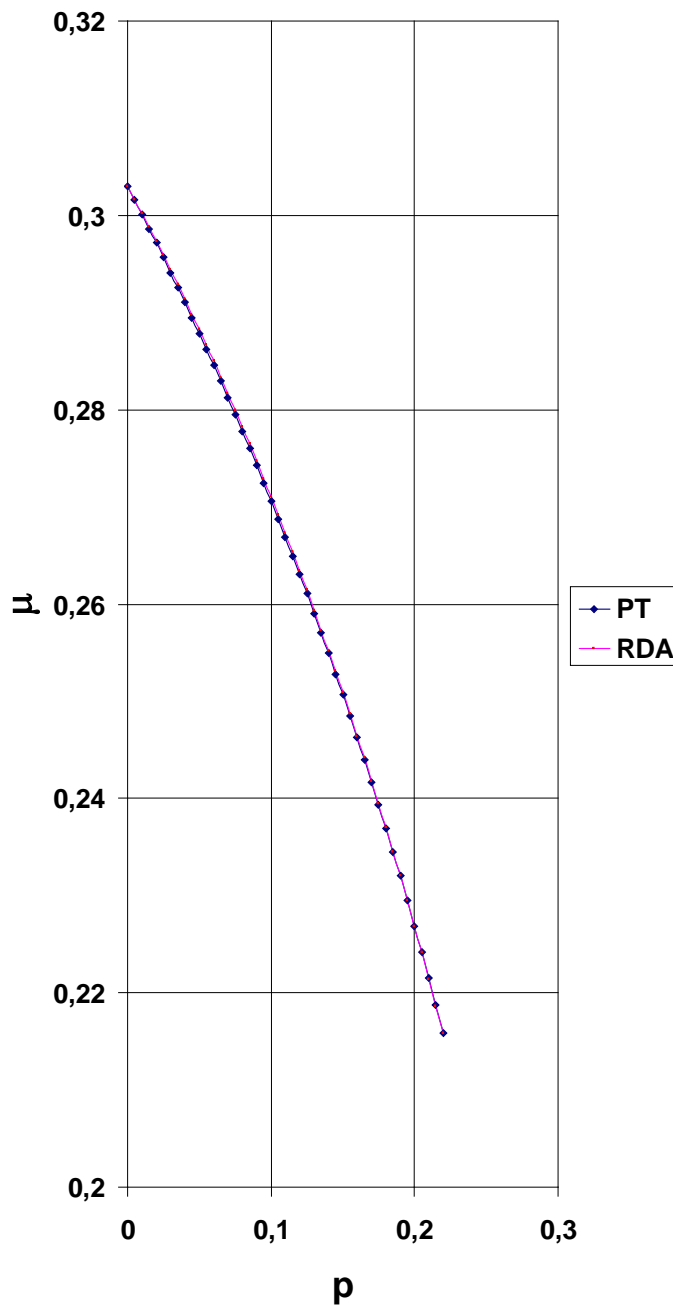

Figure 4. Graphical comparison of Poisson's ratio versus porosity according to the percolation theory and the RDA model for sintered iron from Figure 1 in [7]

The curve of the function of difference $\mu_{PT}(p) - \mu_{RDA}(p)$ for the interval $[0, p_E]$ is shown in Figure 5. It can be concluded that the differences are very small, i.e., insignificant in this example.

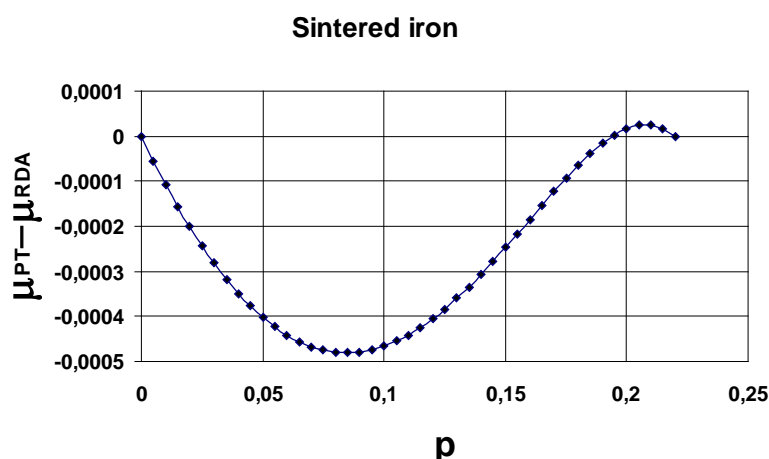

Figure 5. Differences between the percolation theory and the RDA model for sintered iron from Table I in [7]

At the limits of the porosity range, both models always give the same results. However, the theory of percolation gives the limit value of the Poisson's ratio -1 at the percolation threshold, while the damage variable of -2 is not a real value.

On the other hand, the RDA model gives the Poisson ratio close to zero at the percolation threshold

$$\mu_{RDA}(p_{max}) = \frac{\varphi^* - \frac{p_{max}(\varphi^* - \varphi_E)}{p_E}}{2 \left[1 + \varphi^* - \frac{p_{max}(\varphi^* - \varphi_E)}{p_E} \right]} = \frac{1.53807 - \frac{0.41(1.53807 - 0.75965)}{0.22}}{2 \left[1 + 1.53807 - \frac{0.41(1.53807 - 0.75965)}{0.22} \right]} = 0.04 .$$

Hence,

$$\varphi(p_{max}) = \frac{2 \cdot 0.04}{1 - 2 \cdot 0.04} = 0.087 ,$$

$$D(p_{max}) = \frac{0.087}{1 + 0.087} = 0.08 .$$

The damage variable of 0.08 is within the prescribed range of $0 \leq D \leq 1$, but is not in the range of critical values according to the RDA model, where $0.606 \geq D \geq 0.43$.

Although the negative Poisson's ratio for solid materials is not a measurable quantity, it is theoretically provable. According to the Cauchy–Hooke law for isotropic materials and as a consequence of the second law of thermodynamics, the following inequality must hold for isotropic materials, $-1 < \mu < 0.5$. However, in some older literature, the prevailing opinion was that the Poisson's ratio should always be positive for isotropic materials, which means that the results of the RDA are closer to reality.

On the other hand, the negative Poisson's ratio implies a negative damage variable, which is a very little researched theoretical case. Furthermore, the negative damage variable implies a negative crack density in the part of the range, [19]. In the appropriate regions, the actual cracks are replaced by the stiffening-rigid lamellae. These solid elements are referred to in the literature as negative cracks or anti-cracks, [20].

The differences in the results between the percolation theory and the RDA model depend primarily on the choice of the percolation threshold p_{max} , but also on the characteristic exponents f_E and f_G that are in the percolation formulas.

It is generally accepted that the value of the percolation threshold is a function of powder size, shape, size and distribution of shapes, and methods of preparation, [21]. In this paper, the RDA model is related to percolation theory in order to compare the results. The connecting parameter is the Poisson's ratio μ_E calculated according to the percolation theory at the limit p_E of the predicted porosity range. It is then included in the formulas according to the RDA model to obtain the creep

coefficient φ_E . The obtained differences for all analyzed metals are small and different, but they are a consequence of the choice of percolation threshold and exponents f_E and f_G . The curves of the critical damage variables as a function of porosity for all analyzed metals in [7], but based on the RDA model, are shown in Figure 6. In the case of porous ZnO, the results show that the critical damage variable is probably independent of porosity.

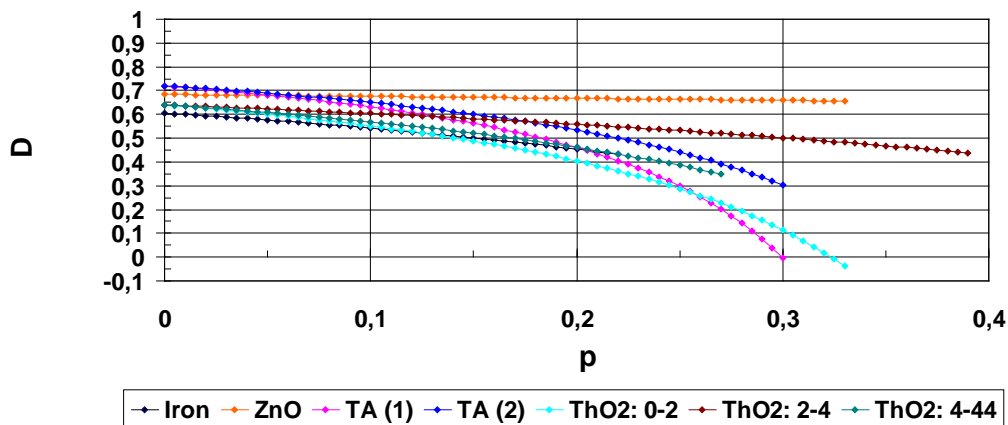

Figure 6. Graphical comparison of the critical damage variable as a function of porosity for all analyzed metals [7] according to the RDA model

5. CONCLUDING REMARKS

Percolation theory and the RDA model are based on completely different physical principles, so comparing their results with experimental ones is extremely important. Based on the principles of conservation of mass and energy during the wave movement between two cross sections of the sample, a new linear relationship between the creep coefficient and porosity is defined. The validity of this relationship is confirmed by comparing the dependence of the Poisson ratio on porosity according to the RDA model with the correlation results obtained according to the percolation theory.

It is obvious that the RDA model can be applied independently of the percolation theory, but it is first necessary to determine the limit of the porosity range p_E and Poisson ratio at that limit.

LITERATURE

- [1] J. A. Choren, S. M. Heinrich, and M. B. Silver-Thorn, "Young's modulus and volume porosity relationships for additive manufacturing applications," *Journal of Materials Science*, vol. 48, no. 15, pp. 5103–5112, Aug. 2013, doi: 10.1007/s10853-013-7237-5.
- [2] R. M. Spriggs, "Expression for Effect of Porosity on Elastic Modulus of Polycrystalline Refractory Materials, Particularly Aluminum Oxide," *J. Am. Ceram. Soc.*, vol. 44, no. 12, pp. 628–629, Dec. 1961, doi: 10.1111/J.1151-2916.1961.TB11671.X.
- [3] E. Ryshkewitch, "Compression Strength of Porous Sintered Alumina and Zirconia," *J. Am. Ceram. Soc.*, vol. 36, no. 2, pp. 65–68, Feb. 1953, doi: 10.1111/J.1151-2916.1953.TB12837.X.
- [4] K. K. Phani and S. K. Niyogi, "Young's modulus of porous brittle solids," *J. Mater. Sci.* 1987 221, vol. 22, no. 1, pp. 257–263, Jan. 1987, doi: 10.1007/BF01160581.
- [5] J. C. Wang, "Young's modulus of porous materials," *J. Mater. Sci.*, vol. 19, no. 3, pp. 801–808, Mar. 1984, doi: 10.1007/BF00540451.
- [6] J. Kováčik, "Correlation between Young's modulus and porosity in porous materials," *J. Mater. Sci. Lett.*, vol. 18, no. 13, pp. 1007–1010, 1999, doi: 10.1023/A:1006669914946.
- [7] J. Kováčik, "Correlation between Poisson's ratio and porosity in porous materials," *J. Mater. Sci.*, vol. 41, no. 4, pp. 1247–1249, Feb. 2006, doi: 10.1007/S10853-005-4237-0.
- [8] D. D. Milašinović, "Rheological-dynamical analogy: Prediction of damping parameters of hysteresis damper," *Int. J. Solids Struct.*, vol. 44, no. 22–23, pp. 7143–7166, Nov. 2007, doi: 10.1016/j.ijsolstr.2007.04.001.

- [9] D. D. Milašinović, "Rheological-dynamical analogy: Modeling of fatigue behavior," *Int. J. Solids Struct.*, vol. 40, no. 1, pp. 181–217, 2003, doi: 10.1016/S0020-7683(02)00518-8.
- [10] D. D. Milašinović, "Rheological–dynamical analogy: visco-elasto-plastic behavior of metallic bars," *Int. J. Solids Struct.*, vol. 41, no. 16–17, pp. 4599–4634, Aug. 2004, doi: 10.1016/j.ijsolstr.2004.02.061.
- [11] D. D. Milasinovic, "Rheological-dynamical continuum damage model for concrete under uniaxial compression and its experimental verification," *Theor. Appl. Mech.*, vol. 42, no. 2, pp. 73–110, 2015, doi: 10.2298/tam1502073m.
- [12] P. H. Mott and C. M. Roland, "Limits to Poisson's ratio in isotropic materials," *Phys. Rev. B - Condens. Matter Mater. Phys.*, vol. 80, no. 13, p. 132104, Oct. 2009, doi: 10.1103/PhysRevB.80.132104.
- [13] D. Krajcinovic, D. Sumarac, and K. Mallick, "Elastic Parameters of Brittle, Elastic Solids Containing Slits — Critical State," *Int. J. Damage Mech.*, vol. 1, no. 4, pp. 386–403, 1992, doi: 10.1177/105678959200100402.
- [14] J. Lemaitre, "How to use damage mechanics," *Nucl. Eng. Des.*, vol. 80, no. 2, pp. 233–245, Jul. 1984, doi: 10.1016/0029-5493(84)90169-9.
- [15] J. Kováčik, "Correlation between shear modulus and porosity in porous materials," *J. Mater. Sci. Lett.*, vol. 20, no. 21, pp. 1953–1955, Nov. 2001, doi: 10.1023/A:1013186702962.
- [16] I. Balberg, "Universal percolation-threshold limits in the continuum," *Phys. Rev. B*, vol. 31, no. 6, pp. 4053–4055, Mar. 1985, doi: 10.1103/PhysRevB.31.4053.
- [17] D. D. Milašinović, "Rheological-dynamical method for prediction of compressive strength and deformation of rocks," *Int. J. Rock Mech. Min. Sci.*, vol. 141, p. 104659, May 2021, doi: 10.1016/j.ijrmms.2021.104659.
- [18] J. P. Panakkal, H. Willems, and W. Arnold, "Nondestructive evaluation of elastic parameters of sintered iron powder compacts," *J. Mater. Sci.*, vol. 25, no. 2, pp. 1397–1402, Feb. 1990, doi: 10.1007/BF00585456.
- [19] V. A. Lubarda and D. Krajcinovic, "Damage tensors and the crack density distribution," *Int. J. Solids Struct.*, vol. 30, no. 20, pp. 2859–2877, Jan. 1993, doi: 10.1016/0020-7683(93)90158-4.
- [20] J. Dundurs and X. Markenscoff, "A Green's Function Formulation of Anticracks and Their Interaction With Load-Induced Singularities," *J. Appl. Mech.*, vol. 56, no. 3, pp. 550–555, Sep. 1989, doi: 10.1115/1.3176126.
- [21] S. Spinner, F. P. Knudsen, and L. Stone, "Elastic constant- porosity relations for polycrystalline thoria," *J. Res. Natl. Bur. Stand. Sect. C Eng. Instrum.*, vol. 67C, no. 1, pp. 39–46, Jan. 1963, doi: 10.6028/JRES.067C.005.



Miloš Jočković, University of Belgrade, milosjockovic32@gmail.com
Marija Nefovska-Danilović, University of Belgrade, marija@grf.bg.ac.rs
Aleksandar Borković, University of Belgrade, Graz University of Technology,
aleksandar.borkovic@aggf.unibl.org

ISOGOMETRIC ANALYSIS OF A SPATIALLY CURVED BERNOULLI-EULER BEAM SUBJECTED TO MOVING LOAD

Abstract

Dynamic analysis of a spatially curved Bernoulli-Euler beam subjected to the moving load is considered in this paper. The isogeometric approach is used for the spatial discretization of the weak form of the equation of motion. Both the reference geometry and the solution space are represented using the same NURBS basis functions that guarantee an accurate description of beam's centerline. The time integration is done by the explicit technique. The presented formulation is validated by the comparison with the existing results from the literature for the curved beam subjected to the constant load moving with the constant velocity.

Keywords: isogeometric approach, Bernoulli-Euler curved beam, moving load

ИЗОГЕОМЕТРИЈСКА АНАЛИЗА УТИЦАЈА ПОКРЕТНОГ ОПТЕРЕЋЕЊА НА ПРОСТОРНОЈ КРИВОЛИНИЈСКОЈ БЕРНУЛИ-ОЈЛЕРОВОЈ ГРЕДИ

Сажетак

У овом раду је приказана динамичка анализа просторне криволинијске Бернули-Ојлерове греде под утицајем покретног оптерећења. Изогеометријски приступ је примењен у циљу просторне дискретизације слабе форме једначина кретања греде. Овај приступ се базира на примени истих базних NURBS функција за описивање геометрије и кинематике криволинијске греде, чиме је омогућен тачан приказ системне линије греде. Временска интеграција једначина је извршена применом експлицитне методе. Приказана формулација је валидирана поређењем са резултатима из литературе за случај криволинијске греде оптерећене покретном силом константног интензитета и брзине.

Кључне ријечи: изогеометријски приступ, Бернули-Ојлерова крива греда, покретна сила

1. INTRODUCTION

Beam-like structures are often subjected to dynamic loads during their lifetime. Therefore, the dynamic analysis of beam elements is necessary for an accurate prediction of their real-life behavior. One type of the dynamic loads is the mass that moves along the structure, which is the standard load case for cranes and bridges. The moving mass is usually modeled as a moving force with constant magnitude and direction. Such approach gives a moving load model where the inertial term of the moving mass is neglected. Majority of the research in this field is related to the analysis of a mass moving along a straight beam. One of the earliest investigations was carried out by Stokes in 1849 [1], where the influence of the moving mass on the plane straight Bernoulli-Euler beam was considered analytically using the moving load model.

Due to the aesthetic and functional requirements in the design process, curved spatial beam elements cannot be avoided. Geometrical model of the curved spatial beam requires the spatial curve, which can be obtained using computer-aided design (CAD) software packages. To accurately describe the free-form curves and the curves of conic sections such as circle, ellipse, parabola and hyperbola, CAD packages utilize the NURBS (Non-Uniform Rational B-Spline) basis functions.

In order to conduct the general dynamic analysis of complex spatially curved beams subjected to the moving load, numerical methods are essential. Nowadays, the Finite Element Method (FEM) is implemented in most software packages for structural analysis. A direct relation between CAD and FEM has not yet been established [2], leading to costly and time-consuming iterative design process. The isogeometric approach establishes a direct relationship between the geometry and the unknown fields of the structure [2]. This is enabled by using the NURBS functions as basis functions of the numerical model's reference and solution spaces. Therefore, the same basis functions are applied for the geometry and kinematics, which eliminates the errors due to the geometric approximation in a spatially discretized model. In order to improve the mesh, three types of mesh refinement are used in the isogeometric approach, denoted as H-, P-, and K-methods [2].

A dynamic analysis of an arbitrarily curved spatial beam subjected to the moving load is studied in this paper. A short review on the NURBS basis function is given in Section 2 and followed by the beam's geometry representation. The governing equation of motion of the Bernoulli-Euler isogeometric beam element is briefly given in Section 4, while more details can be found in authors' previous paper [3]. The moving load model is presented in Section 5 and followed by the numerical example of spatially curved beam subjected to the moving load in Section 6. At the end, the main conclusions have been drawn.

2. BASICS OF NURBS

The exact shape of an arbitrary curve $C(\xi)$ in Euclidean 3D space can be represented as:

$$C(\xi) = \sum_{i=1}^n R_{i,p}(\xi) C_i \quad (1)$$

where $R_{i,p}(\xi)$ is the i -th NURBS basis function, p is the function degree, C_i is the position of the control point i , while n is the number of basis functions and control points. NURBS functions are derived from the B-spline functions:

$$R_{i,p}(\xi) = \frac{N_{i,p}(\xi) \cdot w_i}{\sum_{j=1}^n N_{j,p}(\xi) \cdot w_j} \quad (2)$$

where w_i is the i -th function weight. In order to define B-spline functions, Cox de Boor algorithm is often applied [4].

For the case of a zero degree ($p = 0$), the B-spline functions are defined as:

$$N_{i,0}(\xi) = \begin{cases} 1, & \text{if } \xi \in [\xi_i, \xi_{i+1}[\\ 0, & \text{otherwise} \end{cases} \quad (3)$$

while for the polynomial degree greater than zero ($p > 0$):

$$N_{i,p}(\xi) = \begin{cases} \frac{\xi - \xi_i}{\xi_{i+p} - \xi_i} N_{i,p-1}(\xi) + \frac{\xi_{i+p+1} - \xi}{\xi_{i+p+1} - \xi_{i+1}} N_{i+1,p-1}(\xi), & \text{if } \xi \in [\xi_i, \xi_{i+p+1}[\\ 0, & \text{otherwise} \end{cases} \quad (4)$$

The B-spline functions are polynomial functions defined in parametric domain (ξ) using the knot vector. This vector represents a set of non-decreasing real numbers, the knots.

Important properties of the B-spline function, as well as the NURBS functions, used in the following derivations, are the non-negativity and the partition of unity over the parametric domain. More about the B-spline and NURBS basis functions can be found in [4].

3. BEAM GEOMETRY

Due to the assumptions of beam theories, all kinematic and stress quantities of a beam can be given as a function of beam's centerline. In general, the beam's centerline has an arbitrary shape in the Euclidean three-dimensional space, forming a curved line. The formulation of a curved beam is conducted using the curvilinear coordinate system attached to the beam's centerline.

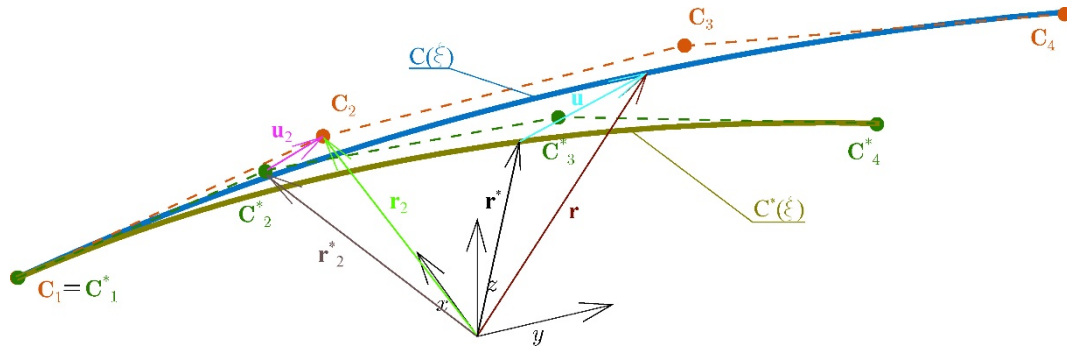

Figure 1. Centerline of a curved beam with corresponding control points

Using the NURBS parameterization, the position vector of a curved line is defined as:

$$\mathbf{r}(\xi) = \sum_{i=1}^n R_{i,p}(\xi) \mathbf{r}_i \quad (5)$$

where \mathbf{r}_i is the position of the i -th control point, Figure 1. To fully define the beam continuum, a unique triad must be attached to each point of a curve. Here, this triad is aligned with the Frenet-Serret frame. The basis vectors are defined using the well-known relations of differential geometry [5] and relations between the arc-length and NURBS parameterizations:

$$\begin{aligned} \mathbf{g}_1 = \mathbf{r}_{,1} &= \frac{d\mathbf{r}}{d\xi} = \frac{d\mathbf{r}}{ds} \frac{ds}{d\xi} = \mathbf{t} \frac{ds}{d\xi} = \mathbf{t} \sqrt{g_{11}} \\ \mathbf{g}_2 = \mathbf{n} &= \frac{1}{K} \frac{d\xi}{ds} \frac{d}{d\xi} \left(\frac{\mathbf{g}_1}{|\mathbf{g}_1|} \right) \\ \mathbf{g}_3 = \mathbf{b} &= \frac{\mathbf{g}_1 \times \mathbf{n}}{|\mathbf{g}_1 \times \mathbf{n}|} \end{aligned} \quad (6)$$

where \mathbf{t} , \mathbf{n} and \mathbf{b} are orthonormal basis vectors of beam's centerline obtained using arc-length parameterization (Frenet-Serret frame of reference), while \mathbf{g}_1 , \mathbf{g}_2 and \mathbf{g}_3 form orthogonal vector basis with respect to the parametric coordinate. The vector \mathbf{g}_1 is collinear with the tangent \mathbf{t} , while the vectors \mathbf{g}_2 and \mathbf{g}_3 are in the beam's cross-section plane. In the previous relations, K is the modulus of curvature, while g_{11} is the component of the metric tensor of the beam's centerline:

$$g_{ij} = \begin{bmatrix} g_{11} & 0 & 0 \\ 0 & 1 & 0 \\ 0 & 0 & 1 \end{bmatrix}, \quad \det(g_{ij}) = g_{11} = g \quad (7)$$

By using the well-known Frenet-Serret relations and Eq. (6), the derivatives of the basis vectors with respect to the parametric coordinate are:

$$\begin{bmatrix} \mathbf{g}_{1,1} \\ \mathbf{g}_{2,1} \\ \mathbf{g}_{3,1} \end{bmatrix} = \begin{bmatrix} \Gamma_{11}^1 & gK & 0 \\ -gK & 0 & \sqrt{g\tau} \\ 0 & -\sqrt{g\tau} & 0 \end{bmatrix} \begin{bmatrix} \mathbf{g}_1 \\ \mathbf{g}_2 \\ \mathbf{g}_3 \end{bmatrix} \quad (8)$$

where $(\cdot)_{,1}$ represents the derivative with respect to the parameter ξ , Γ_{11}^1 is the Christoffel symbol of the second kind, and τ is the torsion of the beam's centerline.

In this paper, the beam cross-section principal axes coincide with the basis vectors \mathbf{g}_2 and \mathbf{g}_3 . If this condition is not satisfied, the basis vectors \mathbf{g}_2 and \mathbf{g}_3 need to be rotated around the basis vector \mathbf{g}_1 to align them with the principal axes, forming a new moving frame of reference [6].

Using the introduced basis vectors, the position vector of an arbitrary point of the beam can be defined as:

$$\hat{\mathbf{r}} = \mathbf{r} + \eta \mathbf{g}_2 + \zeta \mathbf{g}_3 \quad (9)$$

where η and ζ are the coordinates along the principal axes. Consequently, the first basis vector of an arbitrary point is defined as:

$$\hat{\mathbf{g}}_1 = \frac{d\hat{\mathbf{r}}}{d\xi} = \mathbf{g}_{1,1} + \eta \mathbf{g}_{2,1} + \zeta \mathbf{g}_{3,1} = g_0 \mathbf{g}_1 + \eta K_1 \mathbf{g}_2 + \zeta K_1 \mathbf{g}_3 \quad (10)$$

Due to the assumption of the rigid cross-section, the vectors \mathbf{g}_2 and \mathbf{g}_3 are translated from the beam's centerline to an arbitrary point. By observing the metric tensor of an arbitrary point, it is evident that the basis vector $\hat{\mathbf{g}}_1$ is not perpendicular to the vectors \mathbf{g}_2 and \mathbf{g}_3 . To keep the same orthogonal vector basis over the whole cross section, a new parameterization is performed by introducing ξ_2 coordinate. More about this new frame of reference can be found in [6].

4. ISOGOMETRIC BERNOULLI-EULER BEAM FORMULATION

Due to the external impact, the beam's centerline has a new position defined with the current position vector:

$$\mathbf{r}^* = \mathbf{r} + \mathbf{u} \quad (11)$$

where \mathbf{u} represents the displacement vector of the beam's centerline. Using the isogeometric approach, the displacement vector can be represented as:

$$\mathbf{u}(\xi) = \sum_{i=1}^n R_{i,p}(\xi) \mathbf{u}_i = \sum_{i=1}^n R_{i,p}(\xi) u_i^m \mathbf{i}_m \quad (12)$$

where \mathbf{u}_i is the displacement vector of the i -th control point. As can be noticed, the displacement vector and the reference geometry of beam's centerline are represented using the same basis functions, which is the fundamental property of the isogeometric approach.

Formulation of the spatial Bernoulli-Euler isogeometric beam is conducted by applying the convective coordinate system, therefore the position vector of an arbitrary point of a deformed beam is:

$$\hat{\mathbf{r}}^* = \hat{\mathbf{r}} + \eta \mathbf{g}_2^* + \zeta \mathbf{g}_3^* \quad (13)$$

The basis vectors of the deformed configuration can be expressed as:

$$\mathbf{g}_m^* = \mathbf{g}_m + \mathbf{u}_m \quad (14)$$

where \mathbf{u}_m represents the increment of the m -th basis vector.

Using Eqs. (9), (13) and (14), the displacement vector of an arbitrary point of a beam is defined as:

$$\hat{\mathbf{u}} = \mathbf{u} + \eta \mathbf{u}_2 + \zeta \mathbf{u}_3 \quad (15)$$

Using Eq. (15), the acceleration vector of an arbitrary point is obtained as the second material derivative:

$$\hat{\mathbf{a}} = (\ddot{\mathbf{u}}) = \ddot{\mathbf{u}} + \eta \ddot{\mathbf{u}}_2 + \zeta \ddot{\mathbf{u}}_3 \quad (16)$$

In addition, the variation of displacement of an arbitrary point is obtained from Eq. (15) as:

$$\delta \hat{\mathbf{u}} = \delta \mathbf{u} + \eta \delta \mathbf{u}_2 + \zeta \delta \mathbf{u}_3 \quad (17)$$

The components of the Green-Lagrange strain tensor in convective coordinate system are:

$$\hat{\varepsilon}_{ij} = \frac{1}{2} (\hat{\mathbf{g}}_i^* \cdot \hat{\mathbf{g}}_j^* - \hat{\mathbf{g}}_i \cdot \hat{\mathbf{g}}_j) = \frac{1}{2} (\hat{g}_{ij}^* - \hat{g}_{ij}) \quad (18)$$

In the case of beams, the non-zero components of strain tensor are:

$$\begin{aligned} \hat{\varepsilon}_{11} &= \frac{1}{2} (\hat{g}_{11}^* - \hat{g}_{11}) \\ \hat{\varepsilon}_{12} &= \frac{1}{2} (\hat{g}_{12}^* - \hat{g}_{12}) \\ \hat{\varepsilon}_{13} &= \frac{1}{2} (\hat{g}_{13}^* - \hat{g}_{13}) \end{aligned} \quad (19)$$

By substituting the Bernoulli-Euler assumptions into the previous equations, the required kinematic relations are obtained. Degrees of freedom of the isogeometric Bernoulli-Euler beam are the displacements of the beam's centerline and the torsional rotation of the beam's cross-section. The derivations of the kinematic relations can be found in detail in [3].

Assuming the linear elastic material behavior, the constitutive relations can be written as:

$$\hat{S}_i^j = 2\mu \hat{\varepsilon}_i^j + \lambda \delta_i^j \hat{\varepsilon}_m^m \quad (20)$$

where \hat{S}_i^j represents the mixed components of the second Piola-Kirchoff stress tensor, while μ and λ are Lamé's constants.

In order to obtain the equations of motion, the principle of virtual work is used:

$$\int_{V_0} \rho \hat{\mathbf{a}} \cdot \delta \hat{\mathbf{u}} dV_0 + \int_{V_0} \mathbf{S} : \delta \boldsymbol{\varepsilon} dV_0 = \int_{V_0} \hat{\mathbf{f}} \delta \hat{\mathbf{u}} dV_0 \quad (21)$$

where ρ is the mass density, while $\hat{\mathbf{f}}$ is the external load. By substituting Eqs. (16), (17), (19) and (20) into Eq. (21), the governing equation of motion of Bernoulli-Euler isogeometric curved beam subjected to the moving load is obtained:

$$\mathbf{M}\ddot{\mathbf{q}} + \mathbf{K}\mathbf{q} = \mathbf{Q} \quad (22)$$

where \mathbf{M} is the mass matrix, \mathbf{K} is the stiffness matrix, \mathbf{Q} is the vector of equivalent control forces, while \mathbf{q} is the displacement vector of the control points. Solution of this equation requires application of a time integration procedure. The explicit step by step integration has been applied using the finite differences method [7]. The reduced integration has been applied in Eq. (21) [8], and implemented into the original MATLAB code [9].

5. MOVING LOAD

A mass moving along the structure generates a dynamic response. This load can be modeled as a single load with constant magnitude and direction, \mathbf{f}_0 , that moves along a beam with the constant velocity:

$$\begin{aligned} \mathbf{f}(t) &= \mathbf{f}_0 \cdot \delta(\xi - V_\xi t) \\ V_\xi &= \frac{d\xi}{dt} = \frac{ds}{dt} \frac{d\xi}{ds} = \frac{V}{\sqrt{g}} \end{aligned} \quad (23)$$

where V_ξ and V are the magnitudes of velocity with respect to the parametric and arc-length coordinates, respectively.

The vector of equivalent forces of the i -th control point in the case of a point load is:

$$\mathbf{Q}_i = \int_{d\xi} \mathbf{f} \cdot \mathbf{R}_{i,p}(\xi) \sqrt{g} d\xi = \mathbf{f} \cdot \mathbf{R}_{i,p}(\xi_m) \sqrt{g} \quad (24)$$

where ξ_m is the position of the moving load on a beam.

6. NUMERICAL EXAMPLE

The validation study of the proposed formulation is given in this section. The horizontally curved arch with the length $L = 24 \text{ m}$ and the subtended angle $\alpha = 30^\circ$ is subjected to the out-of-plane and the in-plane moving load with constant speed $V = 40 \text{ m/s}$. The displacements and the torsional rotations at both ends of the beam are restrained. The beam's geometry has been modeled with the cubic NURBS, as given in Figure 2.

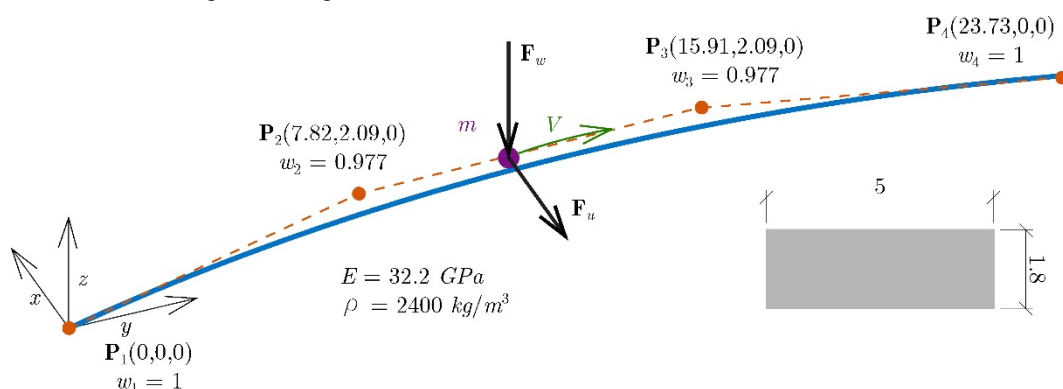

Figure 2. The arch subjected to the moving load

The material is homogeneous and defined using the Young's modulus $E = 32.2 \text{ GPa}$, the Poisson's ratio $\nu = 0.2$ and the mass density $\rho = 2400 \text{ kg/m}^3$, while the cross-section is rectangular with the dimensions $b/h = 5/1.8 \text{ m}$. The beam is subjected to the out-of-plane load $\mathbf{F}_w = -293.32 \text{ kN}$ and the in-plane load $\mathbf{F}_u = 1043.71 \text{ kN}$ directed towards the arch center. The displacements of the beam's midpoint obtained using the isogeometric approach have been compared with the semi-analytical results from the literature, applicable only for the simply supported arches [10]. It is important to point out that the beam model presented in [10] is based on the Timoshenko beam theory. In this example, the validation study is conducted as well as the convergence study using the P-refinement procedure.

The in-plane (u) and the out-of-plane (w) displacement components of the midpoint obtained using the P-refinement procedure are presented respectively in Figure 3 and Figure 4.

In addition, the same example is used to calculate the influence line of the beam's midpoint displacement components by neglecting the inertial part of the beam in the principle of virtual work. By comparing the results of the beam's midpoint displacements obtained using the dynamic and static analysis, significant difference can be observed, especially for the case of the out-of-plane displacement.

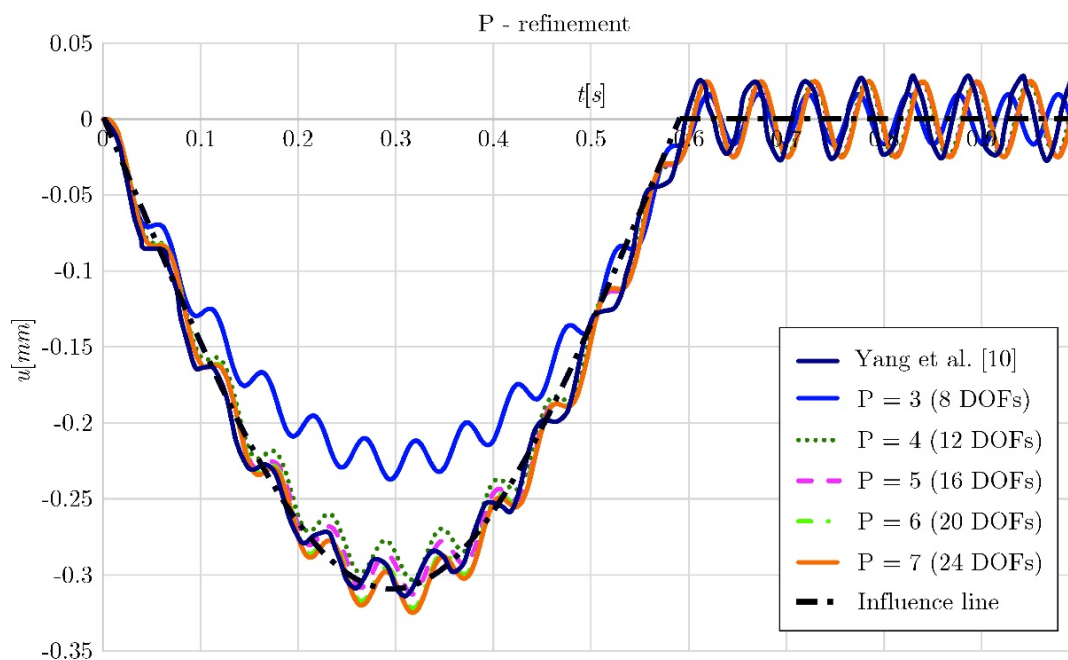

Figure 3. Comparison of in-plane displacement component (u) of the beam's midpoint

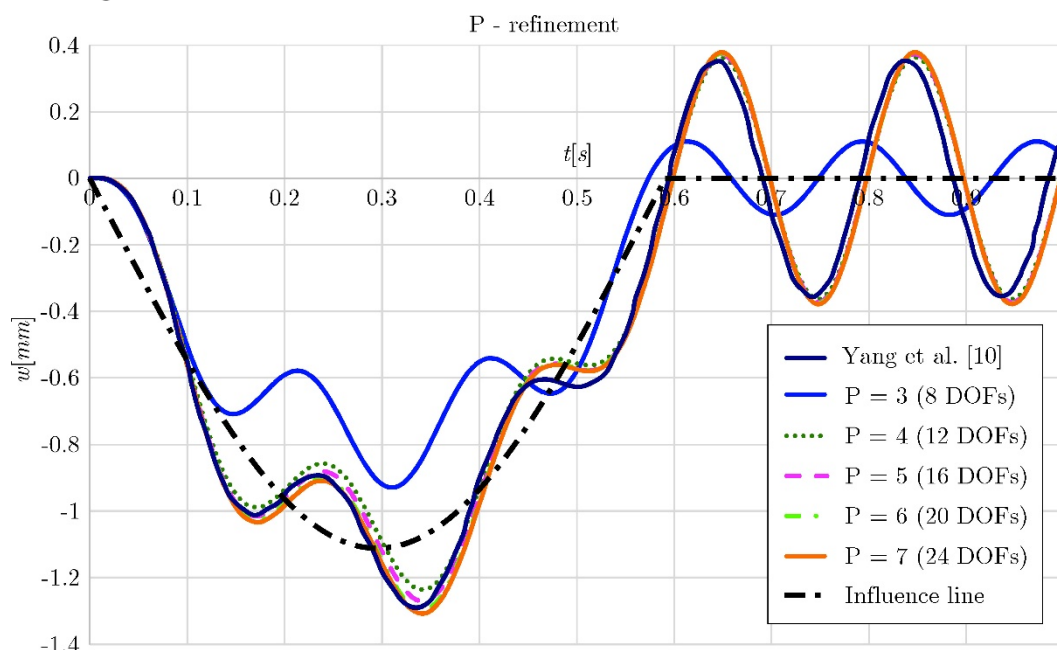

Figure 4. Comparison of the out-of-plane displacement component (w) of the beam's midpoint

7. CONCLUSIONS

The dynamic analysis of spatially curved Bernoulli-Euler beam subjected to the moving load is briefly presented. Spatial discretization is performed by the isogeometric approach, while the explicit procedure is used for the time integration. To validate the proposed method, the numerical study of the curved spatial beam subjected to the point load has been carried out. Satisfactory agreement has been observed between the results obtained using the proposed method and the results from the literature. In addition, the influence line of the beam's midpoint has been calculated, and the difference between the static and dynamic results is shown. The accurate modeling of the moving load has significant influence on the response of a beam. In future work, the inertial part of the moving load will be taken into account, modeling the moving mass more accurately. Also, implicit procedures and effects of the higher-order metric will be considered [11, 12].

ACKNOWLEDGEMENT

M. Jočković and M. Nefovska-Danilović are grateful to the Ministry of Science and Technology of the Republic of Serbia for the financial support of this research within the Projects TR-200092.

A. Borković acknowledges the support of the Austrian Science Fund (FWF): M 2806-N.

LITERATURE

- [1] G. G. Stokes, *Discussion of a Differential Equation relating to the Breaking of Railway Bridges*, Mathematical and Physical Papers vol.2, vol. VI, Cambridge University Press, 1849, pp. 178–220, isbn: 9780511702259, doi: 10.1017/CBO9780511702259.013
- [2] Hughes T. J. R., Cottrell J. A., Bazilevs Y., *Isogeometric analysis: CAD, finite elements, NURBS, exact geometry and mesh refinement*, *Comput. Methods Appl. Mech. Eng.* 194 (39–41), 4135–4195, 2005.
- [3] Jočković M., Radenković G., Nefovska – Danilović M., Baitisch M., *Free vibration analysis of spatial Bernoulli–Euler and Rayleigh curved beams using isogeometric approach*, *Appl. Math. Model.* 71, 152–172, 2019.
- [4] Piegl L., Tiller W., *The Nurbs Book*, Springer, 1997.
- [5] Do Carmo M. P., *Differential Geometry of Curves and Surfaces*, Prentice-Hall, 1976.
- [6] Radenković G., *Finite rotation and finite deformation isogeometric structural analysis (in Serbian)*, University of Belgrade, Faculty of Architecture, 2017.
- [7] Jočković M, Nefovska – Danilović M., *Isogeometric – based dynamic analysis of Bernoulli – Euler curved beam subjected to moving load*, STEPGRAD XIV, Banja Luka, Republic of Srpska, June 11-12, 2020.
- [8] Adam C., Hughes T. J. R., Bouabdallah S., Zarroug M., Maitournam H., *Selective and reduced numerical integrations for NURBS – based isogeometric analysis*, *Computer Methods in Applied Mechanics and Engineering*, vol. 284 , pp. 732 – 761, 2015.
- [9] MathWorks, MATLAB 2013, 2013. <https://www.mathworks.com/products/matlab.html>
- [10] Yang Y. B., Wu C.-M., Yau J.-D., *Dynamic Response of a Horizontally Curved Beam Subjected To Vertical and Horizontal Moving Loads*, *Journal of Sound and Vibration* 242.3 (2001), pp. 519–537, issn: 0022460X, doi: 10.1006/jsvi.2000.3355.
- [11] A. Borković, B. Marussig, G. Radenković, *Geometrically exact static isogeometric analysis of an arbitrarily curved spatial Bernoulli–Euler beam*, *Computer Methods in Applied Mechanics and Engineering*, 390, 114447, 2022, doi: 10.1016/j.cma.2021.114447
- [12] A. Borković, B. Marussig, G. Radenković, *Geometrically exact static isogeometric analysis of arbitrarily curved plane Bernoulli–Euler beam*, *Thin-Walled Structures*, 170, 108539, 2022, doi: 10.1016/j.tws.2021.10853



Aleksandar Borković, University of Banja Luka, Graz University of Technology,
aleksandar.borkovic@aggf.unibl.org

Dijana Majstorović, University of Banja Luka, dijana.majstorovic@aggf.unibl.org

Snježana Milovanović, University of Banja Luka, snjezana.milovanovic@aggf.unibl.org

Duy Vo, Thammasat University and Department of Civil and Environmental Engineering, Tokyo
Institute of Technology, duyvo.ce@gmail.com

FREE VIBRATION ANALYSIS OF SINGLY CURVED CLAMPED SHELLS USING THE ISOGEOMETRIC FINITE STRIP METHOD

Abstract

A hybrid method for the spatial discretization of two-dimensional domains is recently derived and applied to the problem of free vibrations of simply-supported singly curved shells. This new method follows from a tensor product of NURBS functions and a carefully selected series that satisfies boundary conditions a priori. The formulation unifies spatial discretization schemes of the semi-analytical Finite strip method and the Isogeometric analysis. In this paper, the method is improved by implementing the capability to deal with clamped-clamped boundary conditions. The numerical analysis shows that the method has favorable accuracy per DOF, in comparison with the standard finite elements.

Keywords: Isogeometric analysis, finite strips, singly curved clamped shells, free vibrations

АНАЛИЗА СЛОБОДНИХ ВИБРАЦИЈА ЈЕДНОСТРУКО ЗАКРИВЉЕНИХ УКЉЕШТЕНИХ ЉУСКИ ПРИМЈЕНОМ ИЗОГЕОМЕТРИЈСКОГ МЕТОДА КОНАЧНИХ ТРАКА

Сажетак

Хибридни метод за просторну дискретизацију димензионалних домена је недавно изведен и примијењен на проблем слободних вибрација једноструко закривљених слободно ослободених љуски. Поступак је заснован на тензорском производу НУРБС функција и пажљиво одабраних редова који а priori задовољавају граничне услове. Формулација обједињује два приступа просторне дискретизације домена: полуаналитички метод коначних трака и изогeометријску анализу. Кроз овај рад, метод је унапређен увођењем граничних услова укљештења. Нумеричка анализа показује да метод пружа одличан однос тачности рјешења и броја степени слободе, у поређењу са стандардним коначним елементима.

Кључне ријечи: изогeометријска анализа, коначне траке, једноструко закривљене укљештене љуске, слободне вибрације

1. INTRODUCTION

Singly curved shells are readily found in engineering structures in the form of thin-walled beams, roofs, storage tanks, etc. Due to their specific geometric properties, the application of general doubly curved shell models is inefficient in comparison with the reduced models, specifically designed for singly curved shells.

One of the well-established methods for the analysis of such structures is the finite strip method (FSM) which discretizes cross section with polynomials and approximates fields in longitudinal direction with trigonometric series [1], [2]. Recently, the isogeometric analysis (IGA) is combined with the FSM in a way to discretize the cross section with the NURBS functions, which returned the finite-strip isogeometric (FSIGA) formulation [3]. The method is successfully applied in [4] for the analysis of singly curved shells that are simply supported on both ends.

In this paper, the FSIGA is improved so that it can model clamped-clamped boundary conditions. To avoid classic free-vibration mode shapes of a clamped-clamped beam which consist of hyperbolic functions, a different series is utilized, employing only trigonometric functions [5], [6]. In this way, the numerical issues, inherent for the hyperbolic functions, are avoided.

Brief review of the FSIGA and its application to thin singly curved shells is given in the next section. The numerical analysis and conclusions are delivered in the last two sections.

2. FINITE STRIP ISOGEOMETRIC FORMULATION FOR A SINGLY CURVED SHELL

2.1. METRIC OF THE MIDSURFACE

The present analysis is conducted using the convective frame of reference while the complete shell kinematics is defined by the Cartesian components of translation of midsurface.

The boldface lowercase and uppercase letters are used for vectors and tensors/matrices, respectively. The asterisk symbol designates a deformed configuration while the overbar indicates an equidistant surface. The quantities measured with respect to the local, curvilinear, coordinates are labeled with the caret symbol. The Greek index letters take values of 1 and 2 while the Latin indices take values of 1, 2, and 3. The covariant and partial derivatives with respect to the m^{th} coordinate are designated with $(\)_{|m}$ and $(\)_{,m}$, respectively.

The displacement vector of the shell midsurface is $\mathbf{r}=\{x=x^1, y=x^2, z=x^3\}$, Fig. 1, which is here expressed as a tensor product of two families of lines:

$$\mathbf{r} = \mathbf{r}(\xi, \eta) = x^k \mathbf{i}_k = \sum_{I=1}^N R_I(\xi) \sum_{J=1}^M F_J(\eta) \mathbf{r}_{IJ}, \quad x^k = \sum_{I=1}^N R_I(\xi) \sum_{J=1}^M f_J^k(\eta) x_{IJ}^k, \quad \mathbf{r}_{IJ} = x_{IJ}^k \mathbf{i}_k, \quad (1)$$

where $R_I(\xi)$ is NURBS basis function of I^{th} control point. $F_J(\eta)$ is J^{th} term of a series, which for the approximation of reference geometry of singly curved shells reduces to the ones used in the semi-analytical FSM, [6]:

$$F_J = \{f_J^1, f_J^2, f_J^3\} = \{1, \eta, 1\}. \quad (2)$$

\mathbf{r}_{IJ} is the position vector of the I^{th} control point for the J^{th} series term, N is the total number of control points along the ξ direction while M is the total number of series terms. \mathbf{i}_m are the base vectors of the Cartesian coordinate system and $\theta^1 = \xi$ is local curvilinear coordinate, see Fig. 1.

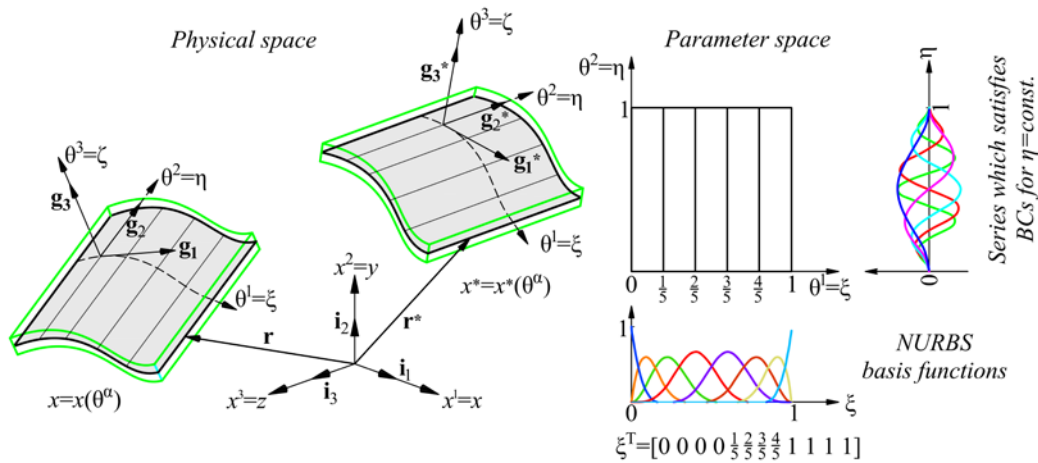

Figure 1. An isogeometric finite strip model. The mapping between the reference and deformed configurations in physical space (left), and parameter space (right). An example of general basis functions is shown next to the parameter space.

The base vectors of the midsurface are:

$$\mathbf{g}_1 = \{x_{,1}^1, 0, x_{,1}^3\}, \quad \mathbf{g}_2 = \{0, 1, 0\}, \quad \mathbf{g}_3 = \{x_{,3}^1, 0, x_{,3}^3\}, \quad (3)$$

where $x_{,n}^m$ are the partial derivatives of the midsurface position with respect to θ^n coordinates. For the adopted description of geometry, components of the base vector \mathbf{g}_1 are:

$$x_{,1}^k = \sum_{I=1}^N \sum_{J=1}^M [R_{I,1}(\xi) f_J^k(\eta)] x_{IJ}^k. \quad (4)$$

Since the second and the third coordinates, $\theta^2 = \eta$ and $\theta^3 = \zeta$, are straight lines, the base vectors \mathbf{g}_2 and \mathbf{g}_3 , and its reciprocal counterparts \mathbf{g}^2 and \mathbf{g}^3 are the same and have unit length. The third coordinate $\theta^3 = \zeta$ is orthogonal to the θ^α coordinates and the base vector \mathbf{g}_3 represents the normal of a midsurface:

$$\mathbf{g}_3 = \mathbf{g}^3 = \mathbf{n} = \frac{1}{\sqrt{g}} (\mathbf{g}_1 \times \mathbf{g}_2) = x_{,3}^m \mathbf{i}_m, \quad x_{,3}^m = x_{m,3} = \frac{1}{\sqrt{g}} x_{,1}^k x_{,2}^l e_{klm} = -x_{,1}^3 \mathbf{i}_1 + x_{,1}^1 \mathbf{i}_3, \quad (5)$$

where e_{mnk} is the permutation symbol and g is the determinant of metric tensor of midsurface:

$$g_{ij} = x_{,i}^k x_{,j}^k = \begin{bmatrix} x_{,1}^m x_{m,1} & 0 & 0 \\ 0 & 1 & 0 \\ 0 & 0 & 1 \end{bmatrix}, \quad g = \det g_{ij} = g_{11}. \quad (6)$$

The reciprocal metric tensor of midsurface is:

$$g^{ij} = g_{ij}^{-1} = \frac{1}{g} \begin{bmatrix} 1 & 0 & 0 \\ 0 & g_{11} & 0 \\ 0 & 0 & g_{11} \end{bmatrix} = \begin{bmatrix} g^{11} & 0 & 0 \\ 0 & 1 & 0 \\ 0 & 0 & 1 \end{bmatrix}, \quad \det g^{ij} = 1/g, \quad (7)$$

and the reciprocal tangent vector \mathbf{g}^1 is:

$$\mathbf{g}^1 = \frac{1}{\sqrt{g}} (\mathbf{g}_2 \times \mathbf{g}_3) = x_n^1 \mathbf{i}^n, \quad x_n^1 = \frac{1}{\sqrt{g}} x_{,2}^m x_{,3}^k e_{mkn} = x_{,3}^3 \mathbf{i}_1 - x_{,3}^1 \mathbf{i}_3. \quad (8)$$

The derivatives of the base vector \mathbf{g}_1 are calculated as:

$$\mathbf{g}_{1,\alpha} = x_{,1\alpha}^m \mathbf{i}_m = \begin{cases} x_{,1\alpha}^m x_{m,k} \mathbf{g}^k = \Gamma_{1\alpha k} \mathbf{g}^k \\ x_{,1\alpha}^m x_m^n \mathbf{g}_n = \Gamma_{1\alpha}^n \mathbf{g}_n \end{cases} \Rightarrow \Gamma_{1\alpha}^n = g^{nk} \Gamma_{1\alpha k}, \quad (9)$$

where $\Gamma_{1\alpha k}$ and $\Gamma_{1\alpha}^n$ are the Christoffel symbols of the first and the second kind, respectively. For the introduced tensor product, Eq. **Error! Reference source not found.**, these derivatives are, [3]:

$$\mathbf{g}_{1,\alpha} = \sum_{I=1}^N [\delta_\alpha^1 R_{I,11}(\xi) \sum_{J=1}^M F_J(\eta) \mathbf{r}_{IJ} + \delta_\alpha^2 R_{I,1}(\xi) \sum_{J=1}^M F_{J,2}(\eta) \mathbf{r}_{IJ}]. \quad (10)$$

The Christoffel symbols $\Gamma_{1\alpha}^3$ are the components of the curvature tensor and we will mark them as $\Gamma_{\alpha\beta}^3 = b_{\alpha\beta}$:

$$\mathbf{g}_{3,\alpha} = -\Gamma_{3\alpha}^\mu \mathbf{g}_\mu = -b_\alpha^\mu \mathbf{g}_\mu, \quad b_\alpha^\mu = g^{\mu\nu} b_{\nu\alpha}, \quad (11)$$

where b_α^μ and $b_{\nu\alpha}$ are the mixed and covariant components of the curvature tensor, respectively, [3]. For singly curved shells, components of the curvature tensor at initial configuration are, Fig. 1:

$$b_1^1 \neq 0, \quad b_2^2 = b_2^1 = b_1^2 = 0. \quad (12)$$

2.2. METRIC OF THE EQUIDISTANT SURFACE

The position vector of an equidistant surface is:

$$\bar{\mathbf{r}} = \mathbf{r} + \zeta \mathbf{g}_3, \quad (13)$$

while its base vectors are:

$$\begin{aligned} \bar{\mathbf{g}}_1 &= \frac{\partial \bar{\mathbf{r}}}{\partial \theta^1} = \mathbf{g}_1 - \zeta b_1^\nu \mathbf{g}_\nu = (\delta_1^\nu - \zeta b_1^\nu) \mathbf{g}_\nu = \bar{C}_1^\nu \mathbf{g}_\nu, \quad \bar{C}_1^1 = 1 - \zeta b_1^1, \quad \bar{C}_1^2 = 0, \\ \bar{\mathbf{g}}_2 &= \mathbf{g}_2, \quad \bar{\mathbf{g}}_3 = \mathbf{g}_3, \end{aligned} \quad (14)$$

where the only non-zero component of the *shift tensor* which is \bar{C}_1^ν [7]. The covariant metric tensor at an equidistant surface is:

$$\bar{g}_{ij} = \bar{x}_{,i}^k \bar{x}_{k,j} = \begin{bmatrix} \bar{x}_{,1}^m \bar{x}_{m,1} & 0 & 0 \\ 0 & 1 & 0 \\ 0 & 0 & 1 \end{bmatrix}, \quad \bar{g} = \det \bar{g}_{ij} = \bar{g}_{11} = (1 - \zeta b_1^1)^2 g_{11} \approx g_{11} - 2\zeta b_{11}, \quad (15)$$

In the previous equation the quadratic term with respect to ζ coordinate is neglected, which is often for thin and moderately thick shells, [8].

2.3. KIRCHHOFF-LOVE THEORY OF A SINGLY CURVED SHELL

The deformed midsurface is defined with the position vector:

$$\mathbf{r}^* = \mathbf{r} + \mathbf{u}, \quad (16)$$

where the displacement \mathbf{u} is approximated with the tensor product of the NURBS functions and a series which satisfies boundary conditions for $\eta = \text{const}$. Here, this series is the same as that used for the description of the geometry, Eq. (1):

$$\mathbf{u} = u^m \mathbf{i}_m = \sum_{I=1}^N R_I(\xi) \sum_{J=1}^M F_J(\eta) \mathbf{u}_{IJ}, \quad u^m = \sum_{I=1}^N R_I(\xi) \sum_{J=1}^M f_J^m(\eta) u_{IJ}^m. \quad (17)$$

\mathbf{u}_{IJ} is the vector of displacement components of the I^{th} control point for the J^{th} series term. It can be written as:

$$\mathbf{u} = \mathbf{N} \mathbf{q} \quad (18)$$

where \mathbf{N} is the matrix of basis functions defined in [4].

The acceleration field is obtained as the second material derivative of the displacement field:

$$\ddot{\mathbf{u}} = \ddot{u}^n \mathbf{i}_n = \mathbf{N} \ddot{\mathbf{q}} \quad (19)$$

According to the KL hypothesis, the expressions for the reference strains of the midsurface for singly curved shells within the scope of the linear theory are, [4]:

$$\begin{aligned} \varepsilon_{11} &= x_{k,1} u_{,1}^k = x_{1,1} u_{,1}^1 + x_{3,1} u_{,1}^3, \\ \varepsilon_{22} &= x_{k,2} u_{,2}^k = u_{,2}^2, \\ 2\varepsilon_{12} &= x_{k,2} u_{,1}^k + x_{k,1} u_{,2}^k = u_{,2}^2 + x_{1,1} u_{,2}^1 + x_{3,1} u_{,2}^3, \\ \kappa_{11} &= x_{k,3} (u_{,11}^k - \Gamma_{11}^{\mu} u_{,\mu}^k) = x_{1,3} u_{,11}^1 + x_{3,3} u_{,11}^3 - \Gamma_{11}^1 (x_{1,3} u_{,11}^1 + x_{3,3} u_{,11}^3), \\ \kappa_{22} &= x_{k,3} (u_{,22}^k - \Gamma_{22}^{\mu} u_{,\mu}^k) = x_{1,3} u_{,22}^1 + x_{3,3} u_{,22}^3, \\ 2\kappa_{12} &= 2x_{k,3} (u_{,12}^k - \Gamma_{12}^{\mu} u_{,\mu}^k) = 2(x_{1,3} u_{,12}^1 + x_{3,3} u_{,12}^3). \end{aligned} \quad (20)$$

while the relations between the equidistant and reference strains are:

$$\bar{\varepsilon}_{\alpha\beta} = \varepsilon_{\alpha\beta}(\zeta) = \frac{1}{2}(\bar{g}_{\alpha\beta}^* - \bar{g}_{\alpha\beta}) \approx \frac{1}{2}(g_{\alpha\beta}^* - g_{\alpha\beta}) - \zeta(b_{\alpha\beta}^* - b_{\alpha\beta}) = \varepsilon_{\alpha\beta} - \zeta \kappa_{\alpha\beta}. \quad (21)$$

The stress-strain relation is defined with the classic Saint Venant-Kirchhoff material model for the plane stress and plane strain conditions:

$$\sigma^{\alpha\beta} = 2\mu(g^{\alpha\nu} g^{\beta\gamma} + \frac{\nu}{1-\nu} g^{\alpha\beta} g^{\nu\gamma}) \varepsilon_{\nu\gamma} = D^{\alpha\beta\nu\gamma} \varepsilon_{\nu\gamma}, \quad (22)$$

where $D^{\alpha\beta\nu\gamma}$ are the components of the constitutive tensor while μ and ν are Lamé constants.

2.4. PRINCIPLE OF VIRTUAL WORK

The principle of virtual work, when the external effects are neglected, can be written as:

$$\delta W = \int_v \bar{\sigma}^{ij} \delta \bar{\varepsilon}_{ij} dv + \int_v \rho \ddot{u}^i \delta \bar{u}_i dv = \int_v \bar{\boldsymbol{\sigma}} : \delta \bar{\boldsymbol{\varepsilon}} dv + \int_v \rho \ddot{\mathbf{u}} \cdot \delta \bar{\mathbf{u}} dv = 0, \quad (23)$$

where $\boldsymbol{\sigma}$ is the Cauchy stress tensor, $\boldsymbol{\varepsilon}$ is the strain tensor, and $\ddot{\mathbf{u}}$ is the vector of accelerations.

After integration of Eq. (23) along the thickness, the internal term reduces to:

$$\int_v \bar{\sigma}^{\alpha\beta} \delta \bar{\varepsilon}_{\alpha\beta} dv = \int_a (N^{\mu\nu} \delta \varepsilon_{\mu\nu} + M^{\mu\nu} \delta \kappa_{\mu\nu}) da, \quad (24)$$

where $N^{\mu\nu}$ and $M^{\mu\nu}$ are the stress resultants and stress couples which are energetically conjugated with the reference strains of the midsurface, $\varepsilon_{\mu\nu}$ and $\kappa_{\mu\nu}$.

By assuming that the material is homogenous and that the effect of rotational inertia is negligible, the inertial term of virtual work reduces to:

$$\int_v \rho \ddot{u}^i \delta \bar{u}_i dv = \rho h \int_a \ddot{u}^i \delta u_i da. \quad (25)$$

Now, Eq. (23) can be written in matrix form as:

$$\delta W = \int_a \mathbf{f}^T \delta \mathbf{e} da + \rho h \int_a \ddot{\mathbf{u}}^T \delta \mathbf{u} da = 0, \quad (26)$$

where \mathbf{f}^T and \mathbf{e}^T are the the vectors of generalized section forces and reference strains of the shell midsurface:

$$\begin{aligned} \mathbf{f}^T &= [N^{11} \quad N^{22} \quad N^{12} \quad M^{11} \quad M^{22} \quad M^{12}], \\ \mathbf{e}^T &= [\varepsilon_{11} \quad \varepsilon_{22} \quad 2\varepsilon_{12} \quad \kappa_{11} \quad \kappa_{22} \quad 2\kappa_{12}]. \end{aligned} \quad (27)$$

The constitutive relations between the energetically conjugated section forces and reference strains can be represented in a compact form as:

$$\mathbf{f} = \mathbf{D} \mathbf{e}, \quad (28)$$

where \mathbf{D} is the constitutive tensor:

$$\mathbf{D} = \begin{bmatrix} \mathbf{D}_M & \mathbf{0} \\ \mathbf{0} & \mathbf{D}_B \end{bmatrix} = \begin{bmatrix} D_M^{\alpha\beta\gamma\lambda} & 0 \\ 0 & D_B^{\alpha\beta\gamma\lambda} \end{bmatrix} \mathbf{g}_\alpha \otimes \mathbf{g}_\beta \otimes \mathbf{g}_\gamma \otimes \mathbf{g}_\lambda. \quad (29)$$

2.5. DISCRETE EQUATION OF MOTION

The relation between the reference strains and the displacements of control points for one isogeometric finite strip can be represented with the strain-displacement matrix \mathbf{B} , defined in [4]:

$$\mathbf{e} = \mathbf{B} \mathbf{q} = \mathbf{L} \mathbf{H} \mathbf{q}, \quad (30)$$

and Eq. (26) can be written as:

$$\delta W = \int_a \mathbf{e}^T \mathbf{D} \delta \mathbf{e} da + \rho h \int_a \ddot{\mathbf{u}}^T \delta \mathbf{u} da = \mathbf{q}^T \int_a \mathbf{B}^T \mathbf{D} \mathbf{B} da \delta \mathbf{q} + \rho h \ddot{\mathbf{q}}^T \int_a \mathbf{N}^T \mathbf{N} da \delta \mathbf{q} = 0, \quad (31)$$

or:

$$\begin{aligned} \mathbf{M} \ddot{\mathbf{q}} + \mathbf{K} \mathbf{q} &= 0, \\ \mathbf{K} &= \int_a \mathbf{B}^T \mathbf{D} \mathbf{B} da, \quad \mathbf{M} = \rho h \int_a \mathbf{N}^T \mathbf{N} da, \end{aligned} \quad (32)$$

where \mathbf{K} and \mathbf{M} are the stiffness and mass matrices of one isogeometric finite strip, respectively. Solving the equation (32) yields a well-known eigenvalue problem:

$$(\mathbf{K} - \omega^2 \mathbf{M}) \tilde{\mathbf{q}} = \mathbf{0}, \quad (33)$$

with $3NM$ nontrivial solutions of eigenpairs of eigenfrequencies ω_i and corresponding eigenvectors $\tilde{\mathbf{q}}_i$.

2.6. SERIES PART OF BASIS FUNCTION

The presented FSIGA, applied to the analysis of singly curved shells, uses series only for the kinematic field. This is analogous to the semi-analytical FSM that enables modeling of all types of classic boundary conditions, [2, 6]. Here, only the clamped-clamped boundary conditions are considered.

It is convenient to utilize two different series. One approximates the two components of a displacement vector in a transverse plane of a shell while the other series approximates the longitudinal (along the η -axis) component of a displacement vector, Fig. 1 [6]. If the longitudinal ends of a strip are clamped, a simple choice for the basis functions f^1 and f^3 is suggested in [5]:

$$f_j^1 = f_j^3 = \sin(J\pi\eta/L) \sin(\pi\eta/L), \quad J = 1, 2, \dots, M, \quad (34)$$

which satisfies boundary conditions: $\hat{u}^1(\xi, 0) = \hat{u}^1(\xi, L) = \hat{u}^3(\xi, 0) = \hat{u}^3(\xi, L) = 0$ and $\hat{u}_{,2}^1(\xi, 0) = \hat{u}_{,2}^1(\xi, L) = \hat{u}_{,2}^3(\xi, 0) = \hat{u}_{,2}^3(\xi, L) = 0$. Regarding the approximation of displacement component along the longitudinal direction, a simple sine series is considered:

$$f_j^2 = \sin(J\pi\eta/L), \quad J = 1, 2, \dots, M, \quad (35)$$

Let us simplify the notation with: $f_m^1 = f_m^3 = Z_m$, $f_m^2 = Y_m$. In this way, the thirteen integrals with respect to the series terms which should be solved in the Eq. (32) are:

$$\begin{aligned}
I_{1mn} &= \int_0^L Z_m Z_n d\eta, \quad I_{2mn} = \int_0^L Z_{m,22} Z_n d\eta, \quad I_{3mn} = \int_0^L Z_{m,22} Z_{n,22} d\eta, \quad I_{4mn} = \int_0^L Z_{m,2} Z_{n,2} d\eta, \\
I_{5mn} &= \int_0^L Y_{m,2} Z_n d\eta, \quad I_{6mn} = \int_0^L Y_m Z_{n,2} d\eta, \quad I_{7mn} = \int_0^L Y_{m,2} Y_{n,2} d\eta, \\
I_{8mn} &= \int_0^L Y_m Y_n d\eta, \quad I_{9mn} = \int_0^L Z_{m,22} Z_{n,2} d\eta, \quad I_{10mn} = \int_0^L Z_{m,22} Y_{n,2} d\eta, \\
I_{11mn} &= \int_0^L Z_{m,2} Y_{n,2} d\eta, \quad I_{12mn} = \int_0^L Y_m Z_n d\eta, \quad I_{13mn} = \int_0^L Z_{m,2} Y_n d\eta.
\end{aligned} \tag{36}$$

The integration of trigonometric functions is here done analytically, cf. Appendix.

3. NUMERICAL EXAMPLES

The aim of the present numerical analysis is to verify and validate the developed FSIGA regarding the singly curved shells with clamped-clamped boundary conditions, and to examine its convergence properties. The numerical reference solutions obtained with highly refined FSIGA meshes are utilized in each experiment. A designation for an IGFSM mesh is $mh-np-ik-jt$, where m , n , i , and j are the number of strips (knot spans), the order of NURBS, the interstrip continuity, and the number of series terms, respectively.

The validation tests are done by the comparison with the results found with dense uniform meshes of STRI3 shell elements. This element is the only one in the Abaqus library which imposes KL constraints analytically, [9].

Additional comparison is made with the standard flat shell finite strips LO2 and HO3 [1, 6].

3.1 AN OPEN CIRCULAR CYLINDER

An open circular cylinder as in Fig. 2 is studied first. The reference FSIGA frequencies for the first eight modes are calculated with 80h-4p-1k-40t mesh and given in Table. 1 The results obtained with a smaller number of degrees of freedom are presented only for the purpose of comparing with the results found with Abaqus. Excellent accuracy per DOF of the FSIGA is evident. Regarding the mode shapes, they are virtually indistinguishable from those in Abaqus, and only the FSIGA results are visualized, Fig. 3.

The results of h -refinement tests are given in Fig. 4. They imply that an increase in the NURBS order and interstrip continuity significantly increases the order of convergence. The convergences of LO2 and HO3 strips are displayed in Fig 5. These flat shell strips have inferior orders of convergence in comparison with the curved NURBS strips of similar order.

The results of t -refinement tests for cubics and quartics NURBS with the lowest and the highest continuities are given in Fig. 6 and Fig. 7. Similar orders of convergence are detected for both models, near 2. The same influence of odd and even series terms as in [4] is observed.

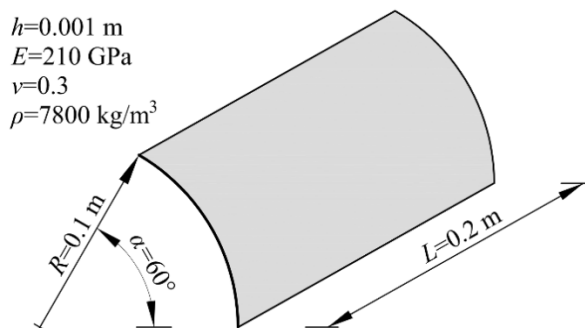

Figure 2. The open circular cylinder.

Table 1. The open circular cylinder. Comparison of the lowest eight eigenfrequencies [Hz].

Mode	Abaqus STRI3		Present	
	1680	167200	20h-2p-1k-10t	80h-4p-1k-40t
	elements ($n_{\text{DOF}}=5412$)	elements ($n_{\text{DOF}}=505260$)	($n_{\text{DOF}}=660$)	($n_{\text{DOF}}=29040$)
1	523.81	505.62	509.58	506.09
2	577.03	569.19	572.10	569.41
3	1011.7	984.35	989.97	984.84
4	1101.3	1070.7	1079.70	1071.84
5	1555.6	1549.6	1562.99	1550.83
6	1587.3	1564.5	1577.03	1565.26
7	1662.2	1632.1	1655.80	1637.02
8	1689.5	1650.5	1665.76	1652.28

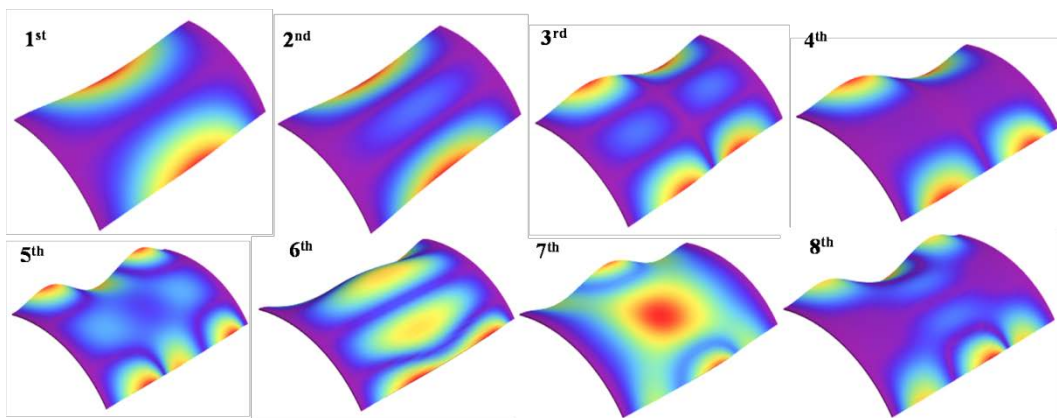

Figure 3. The open circular cylinder. Mode shapes of the lowest eight modes.

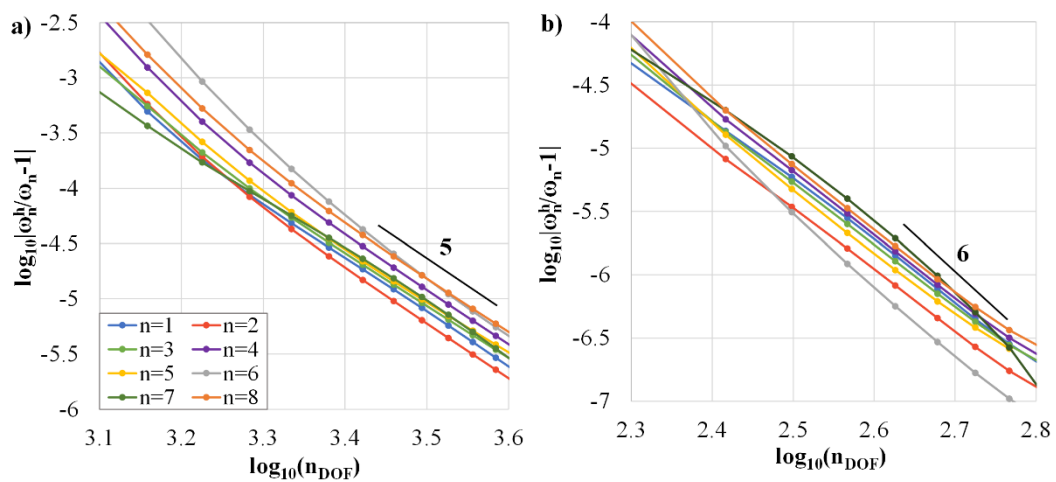

Figure 4. The open circular cylinder. Convergence of the relative error for the lowest eight eigenfrequencies using the h -refinement: a) mh -3p-2k-40t; b) mh -4p-1k-40t

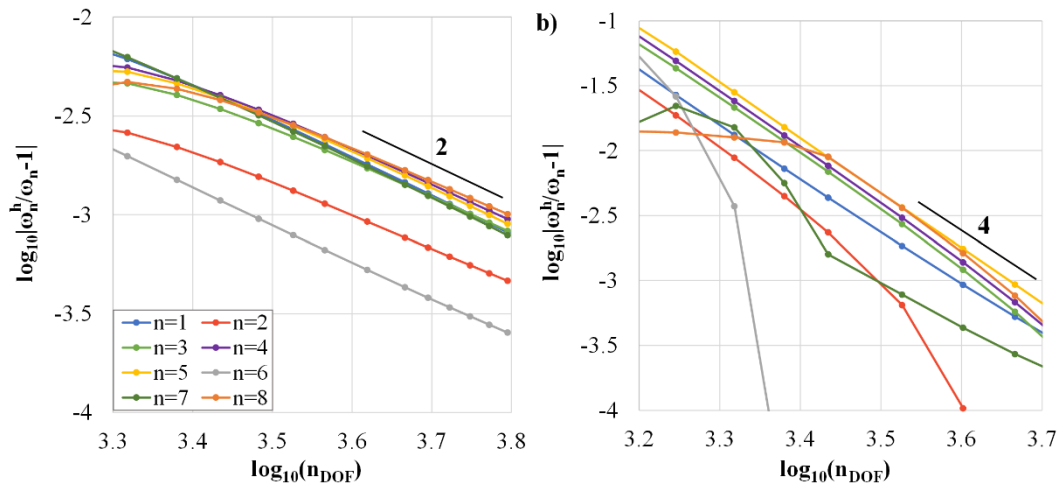

Figure 5. The open circular cylinder. Convergence of the relative error for the lowest eight eigenfrequencies using the h -refinement and forty series terms: a) LO2 strip; b) HO3 strip.

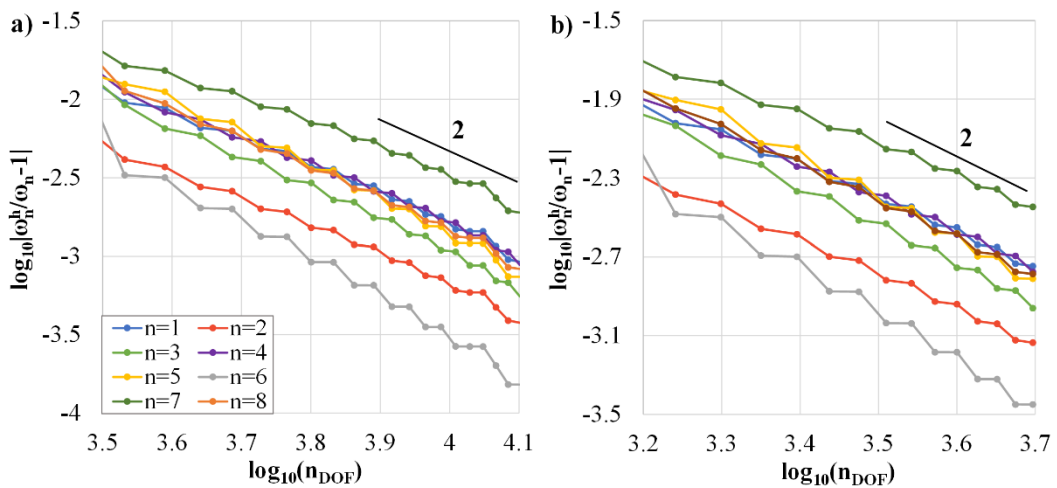

Figure 6. The open circular cylinder. Convergence of the relative error for the lowest eight eigenfrequencies using the t -refinement: a) 80h-3p-1k-jt; b) 80h-3p-2k-jt

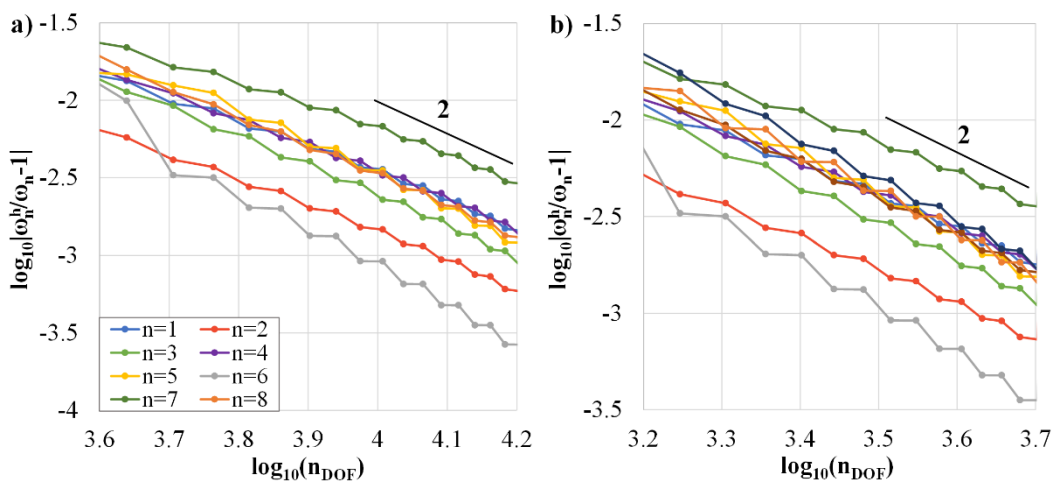

Figure 7. The open circular cylinder. Convergence of the relative error for the lowest eight eigenfrequencies using the t -refinement: a) 80h-4p-1k-jt; b) 80h-4p-3k-jt

3.2 A QUARTIC CYLINDER WITH SYMMETRIC CROSS SECTION

In this example we consider a shell with symmetric circumferential profile, described with the quartic NURBS, Fig. 8. Its parametric equations are:

$$\begin{aligned} x(\xi) &= \frac{0.08 - 0.32 \xi + 1.2 \xi^2 - 1.76 \xi^3 + 0.88 \xi^4}{0.2 + 0.8 \xi - 1.8 \xi^2 + 2 \xi^3 - \xi^4}, \\ z(\xi) &= \frac{-0.45 \xi^2 + 0.1 \xi^3 + 0.25 \xi^4}{-0.2 - 0.8 \xi + 1.8 \xi^2 - 2 \xi^3 + \xi^4}. \end{aligned} \quad (37)$$

The reference mesh is the same as in the previous example, 80h-4p-1k-40t. The lowest eight eigenfrequencies are scrutinized with respect to the results obtained with STRI3 elements in Table 2 while the mode shapes are displayed in Fig. 9.

The convergences of eigenfrequencies with respect to the h -refinement are presented in Fig. 10 and Fig. 11. An astonishing improvement of accuracy per DOF is obtained for meshes with increased smoothness. The t -refinement results are given in Fig. 12 and Fig. 13. The orders of convergences are similar to those estimated in the previous example, close to 2.

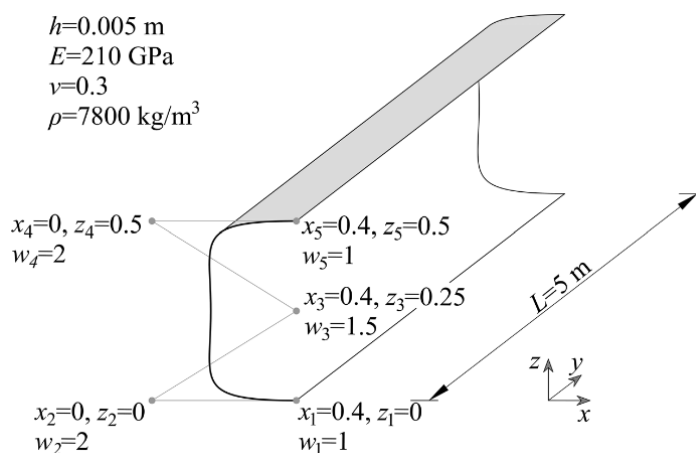

Figure 8. The quartic cylinder. Geometry and material properties. The weights of control points are designated with w_i .

Table 2. The quartic cylinder. Comparison of the lowest eight eigenfrequencies [Hz].

Mode	Abaqus STRI3		Present	
	1608 elements (n _{DOF} =5304)	89000 elements (n _{DOF} =270540)	20h-4p-1k-10t (n _{DOF} =1860)	80h-4p-1k-40t (n _{DOF} =29040)
1	32.74	32.87	32.89	32.87
2	35.97	33.57	33.93	33.64
3	37.78	36.98	37.04	36.96
4	47.38	44.15	44.30	44.10
5	56.41	54.15	55.24	54.81
6	58.95	55.79	56.42	55.89
7	61.51	56.29	56.47	56.33
8	64.16	63.83	63.99	63.82

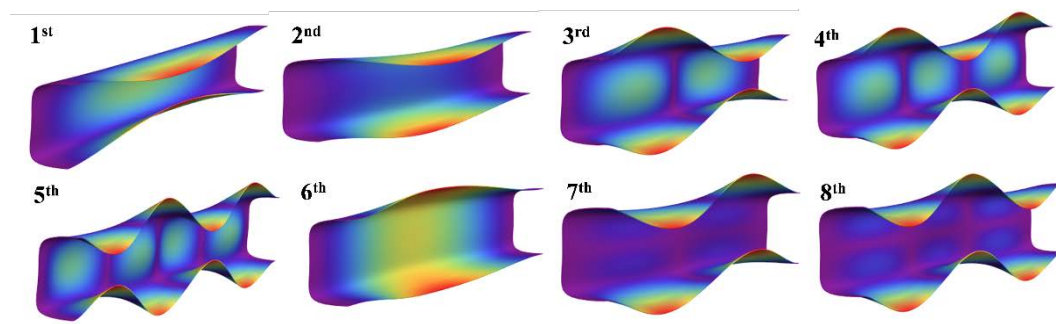

Figure 9. The quartic cylinder. Mode shapes of the lowest eight modes.

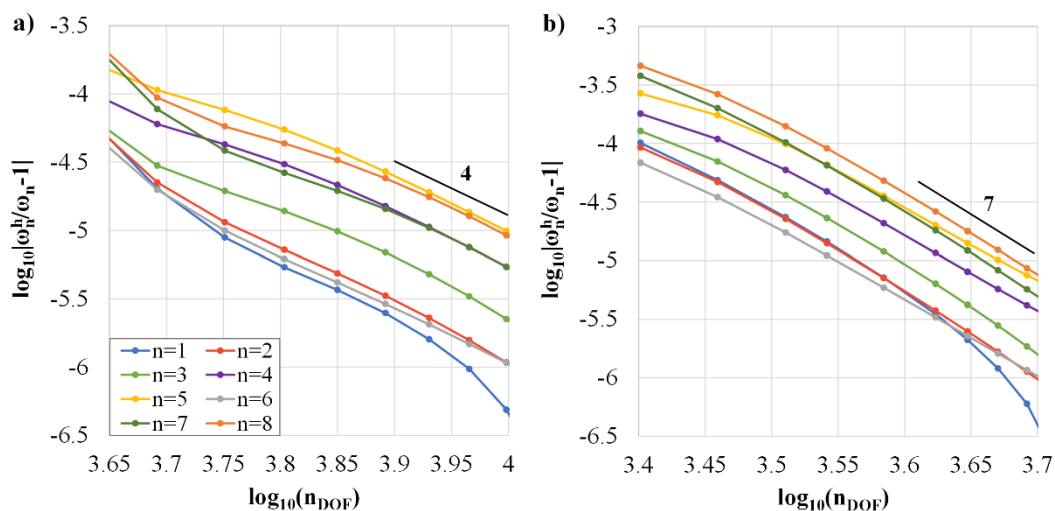

Figure 10. The quartic cylinder. Convergence of the relative error for the lowest eight eigenfrequencies using the h -refinement: a) $mh-4p-1k-40t$; b) $mh-4p-3k-40t$.

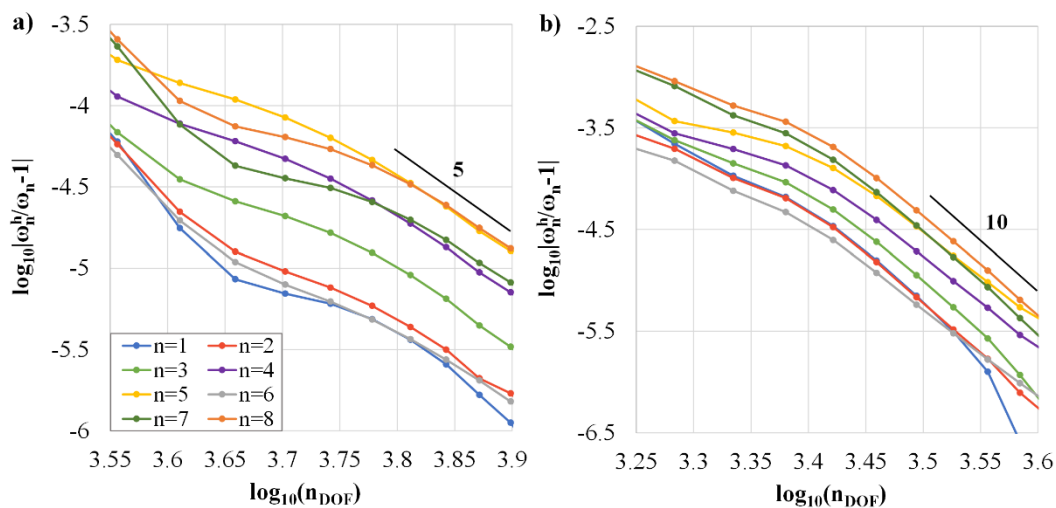

Figure 11. The quartic cylinder. Convergence of the relative error for the lowest eight eigenfrequencies using the h -refinement: a) $mh-5p-1k-40t$; b) $mh-5p-4k-40t$.

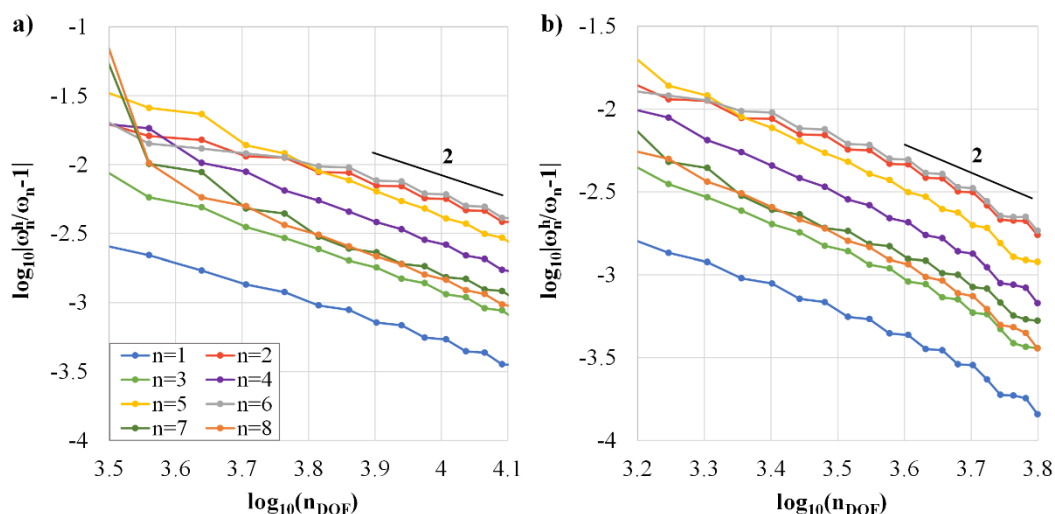

Figure 12. The quartic cylinder. Convergence of the relative error for the lowest eight eigenfrequencies using the t -refinement: a) $80h-4p-1k-jt$; b) $80h-4p-3k-jt$.

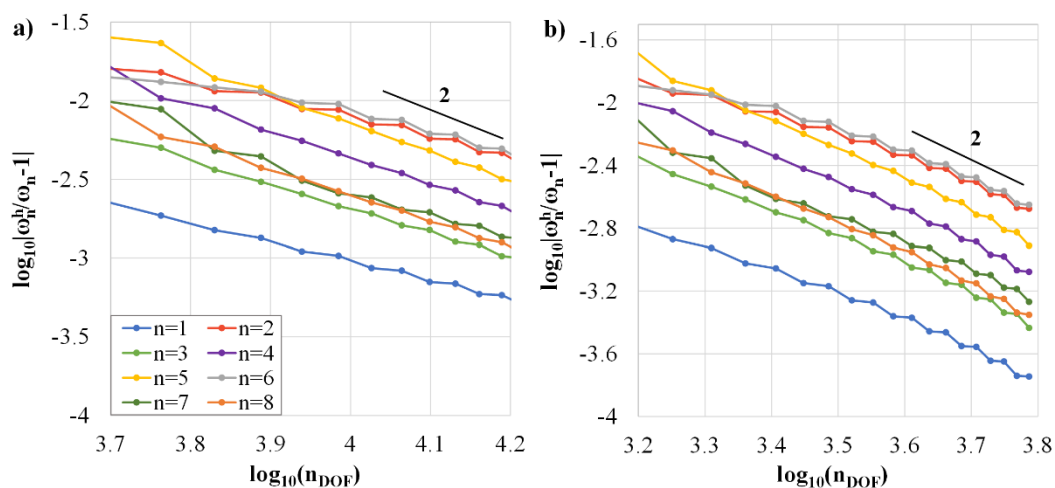

Figure 13. The quartic cylinder. Convergence of the relative error for the lowest eight eigenfrequencies using the t -refinement: a) $80h-5p-1k-jt$; b) $80h-5p-4k-jt$.

4 CONCLUSIONS

The recently developed FSIGA hybrid method is revised and improved by implementing the clamped-clamped isogeometric finite strip. A pure trigonometric series is used and the numerical issues with hyperbolic functions are avoided. As in the previous work, excellent results are obtained in comparison with the finite element method.

The presented method provides improved orders of convergence and allows the analytical integration of trigonometric functions. Additionally, an arbitrarily curved reference geometry can be exactly represented by the NURBS functions. These properties make the FSIGA well-suited for the analysis of singly curved shells.

ACKNOWLEDGMENTS

A. Borković acknowledges the support of the Austrian Science Fund (FWF): M 2806-N.

Appendix A.

Closed-form solutions of the thirteen integrals in Eq. (36) are given here.

$$\begin{aligned}
I_{1mn} &= \begin{cases} \frac{3L}{8}, & m=n=1 \\ \frac{L}{4}, & m=n \neq 1 \\ -\frac{L}{8}, & |m-n|=2 \\ 0, & \text{other} \end{cases}, \quad I_{2mn} = \begin{cases} -\frac{(1+n^2)\pi^2}{4L}, & m=n \\ \frac{(1+n)^2\pi^2}{8L}, & m=n+2 \\ \frac{(-1+n)^2\pi^2}{8L}, & n=m+2 \\ 0, & \text{other} \end{cases}, \quad I_{3mn} = \begin{cases} \frac{(1+6n^2+n^4)\pi^4}{4L^3}, & m=n \\ -\frac{(1+n)^4\pi^4}{8L^3}, & m=n+2 \\ -\frac{(-1+n)^4\pi^4}{8L^3}, & n=m+2 \\ 0, & \text{other} \end{cases}, \\
I_{4mn} &= \begin{cases} \frac{(1+n^2)\pi^2}{4L}, & m=n \\ -\frac{(1+n)^2\pi^2}{8L}, & m=n+2 \\ -\frac{(-1+n)^2\pi^2}{8L}, & n=m+2 \\ 0, & \text{other} \end{cases}, \quad I_{5mn} = \begin{cases} -\frac{(1+n)\pi}{4}, & m=n+1 \\ \frac{(-1+n)\pi}{4}, & n=m+1 \\ 0, & \text{other} \end{cases}, \quad I_{6mn} = \begin{cases} \frac{(1+n)\pi}{4}, & m=n+1 \\ -\frac{(-1+n)\pi}{4}, & n=m+1 \\ 0, & \text{other} \end{cases}, \\
I_{7mn} &= \begin{cases} \frac{n^2\pi^2}{2L}, & m=n \\ 0, & m \neq n \end{cases}, \quad I_{8mn} = \begin{cases} \frac{L}{2}, & m=n \\ 0, & m \neq n \end{cases}, \\
I_{9mn} &= \begin{cases} -\frac{8[-1+(-1)^{m+n}][(-3+n^2+m^2(1+n^2))]m \cdot n \cdot \pi^2}{L^2(-2+m-n)(m-n)(2+m-n)(-2+m+n)(m+n)(2+m+n)}, & |m-n|=1,3,5,K \\ 0, & \text{other} \end{cases}, \\
I_{10mn} &= \begin{cases} -\frac{n^3\pi^3}{4L^2}, & m=n+1 \\ \frac{n^3\pi^3}{4L^2}, & n=m+1 \\ 0, & \text{other} \end{cases}, \\
I_{11mn} &= \begin{cases} -\frac{2[1+(-1)^{m+n}]m \cdot n^3 \cdot \pi}{L(-1+m-n)(1+m-n)(-1+m+n)(1+m+n)}, & |m-n|=0,2,4,K \\ 0, & \text{other} \end{cases}, \\
I_{12mn} &= \begin{cases} -\frac{2[1+(-1)^{m+n}]m \cdot n \cdot L}{(-1+m-n)(1+m-n)(-1+m+n)(1+m+n)\pi}, & |m-n|=0,2,4,K \\ 0, & \text{other} \end{cases}, \\
I_{13mn} &= \begin{cases} -\frac{4[-1+(-1)^{m+n}](-2+m^2+n^2)m \cdot n}{(-2+m-n)(m-n)(2+m-n)(-2+m+n)(m+n)(2+m+n)}, & |m-n|=1,3,5,K \\ 0, & \text{other} \end{cases}.
\end{aligned}$$

LITERATURE

- [1] Y. Cheung and L. Tham, The finite strip method, CRC Press, 1997.
- [2] D. D. Milašinović, The Finite Strip Method in Computational Mechanics, Faculties of Civil Engineering: University of Novi Sad, Technical University of Budapest and University of Belgrade: Subotica, Budapest, Belgrade, 1997.
- [3] G. Radenković, Finite rotation and finite strain isogeometric structural analysis (in Serbian), Belgrade: Faculty of Architecture, 2017.

- [4] A. Borković, G. Radenković, D. Majstorović, S. Milovanović, D. Milašinović and R. Cvijić, “Free vibration analysis of singly curved shells using the isogeometric finite strip method,” *Thin-Walled Structures*, vol. 157, p. 107125, 2020.
- [5] M. A. Bradford and M. Azhari, “Buckling of plates with different end conditions using the finite strip method,” *Computers & Structures*, vol. 56, no. 1, pp. 75–83, 1995.
- [6] A. Borković, S. Kovačević, D. D. Milašinović, G. Radenković, O. Mijatović and V. Golubović-Bugarski, “Geometric nonlinear analysis of prismatic shells using the semi-analytical finite strip method,” *Thin-Walled Structures*, vol. 117, pp. 63–88, 2017.
- [7] M. Bischoff, K. Bletzinger, W. Wall and E. Ramm, “Models and Finite Elements for Thin-Walled Structures,” *Encyclopedia of Computational Mechanics*, 2004.
- [8] J. Kiendl, M.-C. Hsu, M. C. H. Wu and A. Reali, “Isogeometric Kirchhoff–Love shell formulations for general hyperelastic materials,” *Computer Methods in Applied Mechanics and Engineering*, vol. 291, pp. 280–303, 2015.
- [9] *Abaqus Documentation*. Dassault Systèmes, 2014.



Žana Topalović, University of Banja Luka, zana.topalovic@aggf.unibl.org
Nikola Rosić, University of Belgrade, nrosic@grf.bg.ac.rs
Job Udo, HKV - Knowledge entrepreneurs in flood risk and water resources management,
j.udo@hkv.nl

SETTING THE REAL-TIME FLOOD FORECASTING MODELS IN UKRINA, TINJA AND BRKA UNGAUGED BASINS

Abstract

Flood forecasting (FF) is one of the most challenging problems in Hydraulic Engineering. It is also most important due to tremendous contribution in reducing economic and life losses that usually occurs during flooding. Major part of the FF system is hydrologic and hydraulic model that simulate runoff and corresponding water levels in rivers, based on the input data that are results from the meteorologic forecasting model. Major uncertainty of the FF systems that operates in real time usually stems from combined hydrologic-hydraulic model, apart from the large uncertainty that comes from the meteorological model. This uncertainty significantly rises when the catchments of interests are ungauged. In this paper, methodology of setting hydrological and hydraulic model that operates in real time FF and early warning system is presented. Case study are ungauged basins of Ukrina, Tinja and Brka, tributaries of Sava River.

Keywords: flood forecasting system, hydrologic model, hydraulic model, ungauged basins

УСПОСТАВЉАЊЕ МОДЕЛА ЗА ПРОГНОЗУ ПОПЛАВА У РЕАЛНОМ ВРЕМЕНУ НА НЕИЗУЧЕНИМ СЛИВОВИМА УКРИНЕ, ТИЊЕ И БРКЕ

Сажетак

Прогноза поплава је један од најзахтјевнијих задатака у хидротехници, али и најважнијих обзиром на велику улогу у смањењу материјалне штете и губитака људских живота који обично прате феномен поплава. Главни дио прогнозних модела у реалном времену чине хидролошки и хидраулички модел који дају симулације отицаја и одговарајућих нивоа воде у водотоцима на основу резултата симулација метеоролошког прогнозног модела. Највећа неизвјесност резултата прогнозних модела потиче управо од комбинованог хидролошко-хидрауличког модела. Ова неизвјесност постаје већа уколико се ради о хидролошки неизученим сливовима. У овом раду приказана је методологија успостављања хидролошког и хидрауличког модела за потребе система за рану најаву и прогнозу поплава у реалном времену на примјеру неизучених сливова Украине, Тиње и Брке које су директне притоке ријеке Саве.

Кључне ријечи: систем за прогнозу поплава, хидролошки модел, хидраулички модел, неизучени сливови

1. INTRODUCTION

Floods are the most impacting natural disaster in terms of economic damages [1]. Floods also result in thousands of casualties globally each year (4500 in 2019 for example). Flood early warning systems are one of the most efficient measures to reduce the impact of floods, especially when time and budget is limited. Research by JRC[2] illustrates a damage reduction of about 25% for European countries when early warning systems are in place. Besides providing timely warning to the public, flood early warning systems also provide flood managers insights and tools to better understand the water system and communicate in an objective science based manner with other experts and disaster managers.

After the devastating floods in the Sava basin heavily affecting amongst others Bosnia and Herzegovina, several flood early warning systems were developed to timely warn people about potential floods. One of these systems covers the Bosna, Ukrina, Brka and Tinja river catchment in Bosnia and Herzegovina. While Bosna River catchment covers many hydrological and meteorological stations to calibrate and run models that feed the forecasting system, hydrological and meteorological stations on Ukrina, Brka and Tinja basins are sparser. Especially hydrological stations and historical observations are missing essentially making these basins ungauged.

In the flood forecasting systems, hydrological and hydraulic models are vital tool for forecasting current flood condition. These models are usually calibrated upon observed meteorological and hydrological data. When basins do not have any monitoring system, establishing reliable FF system becomes extremely challenging. One of the solutions include regionalization of model parameters [3] with certain basin classification [4] included to consider similarity of two or more basins [5], [6]. Other authors rely on physically based hydrological models [7] but even for them, some kind of calibration/adjustment of model parameters is needed.

This paper presents methodology used in setting up the flood forecasting and early warning system for ungauged basins Ukrina, Tinja and Brka (UTB) in Bosnia and Herzegovina. Integral part of this FF system was Bosna basin also, which is gauged. Data from Bosna subbasins are used to calibrate hydrological NAM model parameters and establish a regression models between calibrated parameters and certain physical and morphological basin' characteristics. Using these regression models, values of NAM parameters are determined for ungauged basins of UTB. Resulting simulation data are compared with regional flow duration curves in order to validate the methodology. Proxy data collected on site during flood in 2010. are also used to check results of combined simulation of hydrologic and hydraulics models. This data served for models' recalibration, where observed water levels didn't agree with simulated one.

2. MIKE MODELS

2.1. GENERAL RAINFALL-RUNOFF MODEL

The NAM model [8] is a deterministic, lumped and conceptual rainfall-runoff model accounting for the water content in up to four different storages: (1) surface storage, (2) lower ground layer – storage of vegetation roots zone, (3) storage of underground water and (4) snow. Different components of rainfall-runoff process continually calculate amounts of water in those storages that are different but intercommunicating vertical components of ground [9].

Surface reservoir is a cultivated top layer of soil with vegetation and surface depressions that hold water. Amount of water in this layer changes in dependence of evapotranspiration, surface runoff and interflow, i.e. water offset from surface into lower layers. In this layer parameter U_{max} (mm) plays a role of maximum amount of water that can be held in this layer. Root zone is next storage in vertical direction in which water comes from the surface layer and offsets to transpiration, interflow to groundwater reservoir, amount of water for filling up groundwater and also smaller part for shallow subsurface runoff. Maximum amount of water in this layer is defined with parameter L_{max} (mm). Underground reservoir is deepest layer of ground in which amount of water comes from previous layer, root zone. Amount of water fulfilling these resources depends on amounts of water in root zone and is regulated with parameter TG (-). NAM has a possibility of adding next, deeper layer whose capacity is controlled by two additional parameters but this addition increase number of model free parameters which usually does not improve model performance [10]. Snow module in NAM model behaves as another storage, in which precipitation (snow) is stored during cold days and gradually discharged in form of melted water during warmer days. For snow module NAM requires just temperatures in same resolution as given precipitation. There are two ways of snow calculation: general - averaged on whole basin and distributed in vertical direction (height zones).

Aside from above mentioned components of model and belonging parameters, there are also parameters which control surface flow as well as amounts of water that set off into lower layers i.e. interflow. Complete list of NAM parameters is shown in Table 1.

Table 1. NAM model parameters

Parameter	Description	Measure unit	Typical values
Surface layer and root zone			
Umax	Maximum capacity of soil humidity in surface layer	mm	10-20
Lmax	Maximum capacity in root zone	mm	50-150
CQOF	Coefficient of surface flow – divides surface water capacity on surface runoff and lower layer infiltration.	-	0,1-0,99
CKIF	Time constant for mid-runoff, runoff between surface layer and root zone. It defines amount of surface water setting off in mid-	hours	200-1000
CK1,2	Time constant for surface and mid-runoff. Defines the shape of hydrograph.	hours	3-48
TOF	Threshold value for surface flow – there is no surface flow if relative humidity of lower soil layer is smaller than this value.	-	0-0,7
TIF	Threshold value for mid-runoff, similar as previous, regarding surface layer.	-	0-0,99
Underground layer			
CKBF	Time constant of basic runoff – defines shape of hydrograph in periods without precipitation.	hours	500-5000
TG	Threshold value in root zone for growth of runoff in underground (similar as TOF)	-	0-0,99
CQLOW	Growth in lower underground layers – defines growth in underground reservoir that goes into lower layers by	-	
CKLOW	Time constant of linear reservoir that is used to model basic runoff.	hours	
Carea	Part of basin that contributes to neighboring basin or part of neighboring basin that seeps into modelled basin.	-	n/a
GWLbf0	Maximum depth to underground water level – measured from average basin height to minimal recipient level	m	10
Sy	Specific growth in underground water	-	0,1
GWLf11	Depth to the level of underground water that defines capillary ascend from lower to higher ground layers upon humidity of	m	
Snow storage			
Csnow	Snow meltdown coefficient	mm/C/day	2-4
T0	Basic temperature that defines precipitation as snow or rain	C	0
Crain	Rain coefficient – defines snow meltdown speed	mm/mm/C/day	

2.2. HYDRAULIC MODEL MIKE 11

For all three tributaries of Sava River, MIKE 11 hydrodynamic models are used to predict water levels and discharges along the river courses during the simulated flood events. The MIKE11 software solves “full” 1D unsteady flow equations but quasi 2D approach can be used by connecting 1D river reaches (parallel branches) [11]. The mass transfer between main channels and floodplains are modelled using so called link channels (Link structure in Figure 1). The link channel is a short branch that usually represents embankment geometry but can also be a model object that represents imaginary (“arbitrary” defined) boundaries between main river and inundations (Figure 2) or even the boundaries inside floodplains when more than one (parallel) river branches represent flow along the same floodplain. The parameters that “control” the dynamic of water mass exchange between main river and floodplains are width-depth relationship, length, slope and Manning n value for link structure.

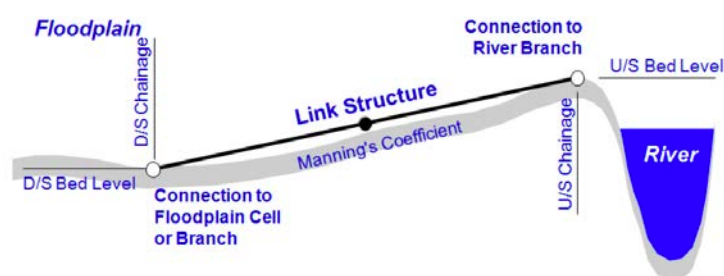

Figure 1. Representation of a Link Channel [12]

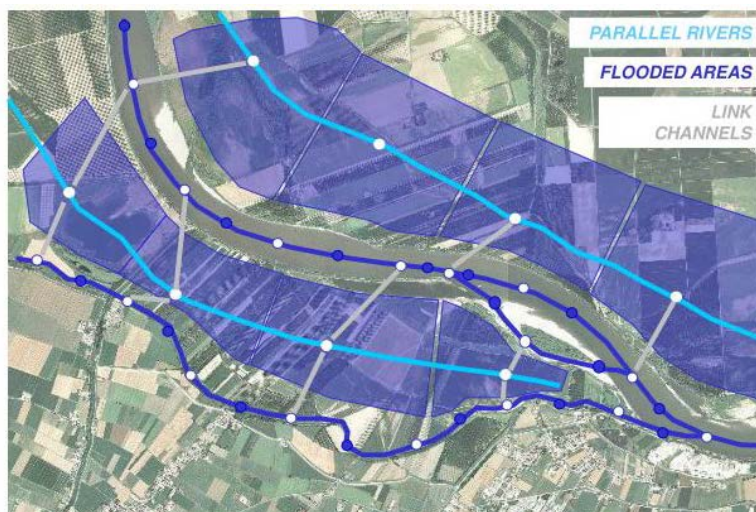

Figure 2. Quazi 2D schematization of river flow [13]

A numerous type of boundary and interior conditions can be set in the hydrodynamic model. User can define hydrographs, stage/discharge relationships or other relationships (or values of their parameters) that represents flow conditions at the outer boundaries or inner parts of the computational domain. The influence of different type of inline or lateral structures (weirs, culverts, sills, etc.) or “outer” water bodies (tributaries and main rivers, storage areas, etc.) on the river flow conditions can be taken into account in 1D flow simulations.

3. BASINS AND DATA

The real-time FF system comprises of the four basins, namely Bosna River Basin, Ukrina, Tinja and Brka (Figure 3). Bosna basin is not in focus in this paper, only the results of hydrological model calibration of Bosna sub-catchments, more specifically the optimized parameters for regionalization. Ukrina, Tinja and Brka (UTB) are right tributaries of Sava River, all three located in BiH. The total areas of UTB are 1500km², 950 km² and 233.2 km², respectively.

Hydrometeorological data collected for the area are mainly precipitation values. Analyzing positions of the stations over the study area with Thiessen polygons it is concluded that polygons around five stations cover the basins area providing dominant areas of point data distribution (see Figure 4). Available data for those stations are summarized in Table 2.

For the basins of Ukrina and Brka, there were no recent observations from monitoring hydrological stations. On Ukrina, daily flows for Derventa station are available only in period between 1964-1983, with gaps. However, those data were used to develop flow duration curves and compare them with simulated ones after the calibration.

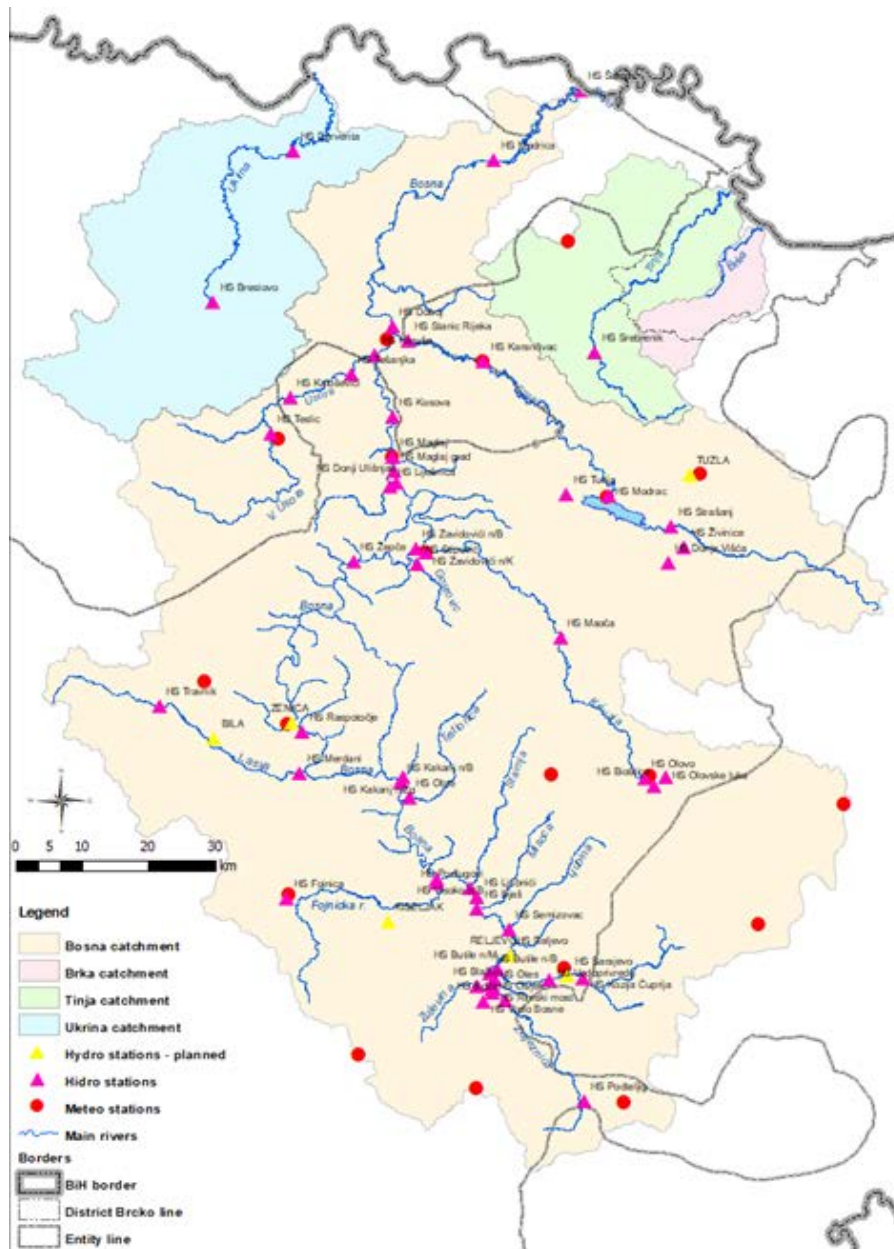

Figure 3. Basins included in FF system [14]

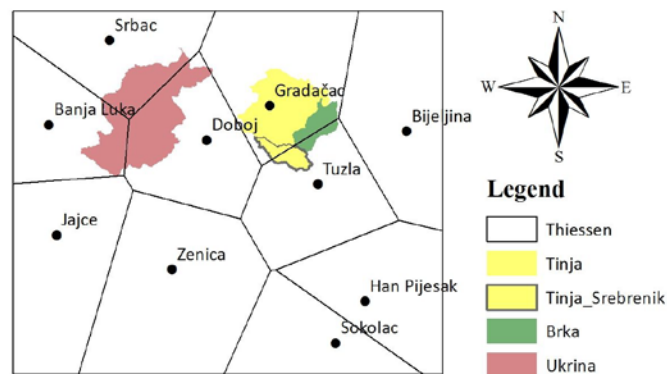

Figure 4. UTB basins and Thiessen polygons developed for 9 meteorological stations that could possibly be used for the areal distribution of precipitation and temperatures

Table 2. Review of available precipitation (P) and temperature (T) data

Meteorological station	Daily P	Daily T	Hourly P	Hourly T
Banja Luka	2008-2018	-	2008-2018*	2008-2017
Doboj	2008-2018	2008-2018	2008-2018*	2015-2018
Gradačac	2008-2015	2008-2014	-	-
Tuzla	2008-2018	2008-2018	2008-2018*	2008-2018
Srbac	2008-2018	2008-2018	2016-2018*	-

*no data from November through March

For Tinja basin there is only one hydrological station (HS Srebrenik) in the upper and mountainous part of the basin. For this HS, hourly water levels for the period 2008-2018 were available as well as rating curves obtained during measurements in period 2010-2016. Upon this data, hourly flows are determined. The only missing period of water level data was the period during and after flood in May 2014, specifically between 15.05.2014-23.06.2014.

4. GENERAL METHODOLOGY FOR SETTING THE HYDROLOGICAL AND HYDRAULIC MODEL

4.1. HYDROLOGICAL MODELLING – MODEL SETUP, CALIBRATION AND SENSITIVITY ANALYSIS

At the initial stage of modeling, Tinja catchment is divided in two sub-catchments at HS Srebrenik. Since there was observed runoff at the Srebrenik station, that part of the catchment is calibrated automatically using autocalibration tool given in NAM [15]. Rest of the basin, as well as whole Ukrina and Brka basins, are calibrated using proposed methodology. For the purpose of combined hydrological and hydraulic modeling, these basins needed to be divided in several sub-catchments – where the inflow is needed in hydraulic reaches. The division of the basins is shown on Figure 5. Ukrina is divided on 14, Tinja on 5 and Brka on 8 sub-catchments. Simulation time step for all models is one hour. Where available, hourly data are used. Otherwise, daily data are interpolated assuming uniform distribution of precipitation within the day. Basic NAM model setup is used, without interflow (CK₂ coefficient) and lower groundwater reservoir, with total of 9 parameters.

Table 3. List of NAM parameters and respective value ranges used in parameter sensitivity analysis

Parameter	Units	Description	Range
U _{max}	mm	Maximum water content in surface storage	5-20
L _{max}	mm	Maximum water content in lower zone/root storage	20-300
CQOF	-	Overland flow coefficient	0.1-1
CKIF	hrs	Interflow drainage constant	200-1000
CK1	hrs	Timing constant for overland flow	0-50
CK2	hrs	Timing constant for interflow	0-50
TOF	-	Overland flow threshold	0-0.99
TIF	-	Interflow threshold	0-0.99
TG	-	Groundwater recharge threshold	0-0.99
CKBF	hrs	Timing constant for baseflow	1000-4000
CQlow	mm	Recharge to groundwater	0-100
CKlow	hrs	Time constant for routing lower baseflow	1000-30000

Prior to ungauged basins calibration procedure, model parameter sensitivity analysis is conducted with full version (all parameters) of NAM model. Sensitivity is analyzed on the gauged Tinja basin part, up to HS Srebrenik by keeping 11 parameters constant while the one for which sensitivity is analyzed is changed by 20% from their respective range (Table 3). For each parameter change, simulation is run and efficiency calculated. When this efficiency is plotted against each parameter value from the predefined range, impact of parameter value change on model performance is well observable. If efficiency is changing little or nothing no matter which value parameter takes, those parameters are insensitive. This means that they do not influence model results i.e., no need to be calibrated. Conversely, when small parameter change induces quite model efficiency change –

impacts heavily on model simulation results, parameter is sensitive. This means that they are important for modelling process and must be calibrated.

Gauged part of the Tinja basin is calibrated upon the available hourly runoff observed at the HS Srebrenik using an automatic optimization algorithm Shuffled Complex Evolution Metropolis – University of Arizona (SCEM-UA, [16]) embedded within the model. This optimization algorithm has a goal to find a single best parameter set in the feasible parameter space (instead of many different sets that give similar model performance). Objective functions used for model calibration are chosen to cover all aspects of hydrograph, i.e., dynamic (root mean square error RMSE), volume (overall volume balance) and matching of the peak flow above certain threshold (RMSE for high flow). The model warm-up period (period that is excluded in objective functions calculation) is set to one year (365 days). After automatic calibration, manual fine-tuning of parameters is performed in order to refine model results to match specific needs of simulation of high flows.

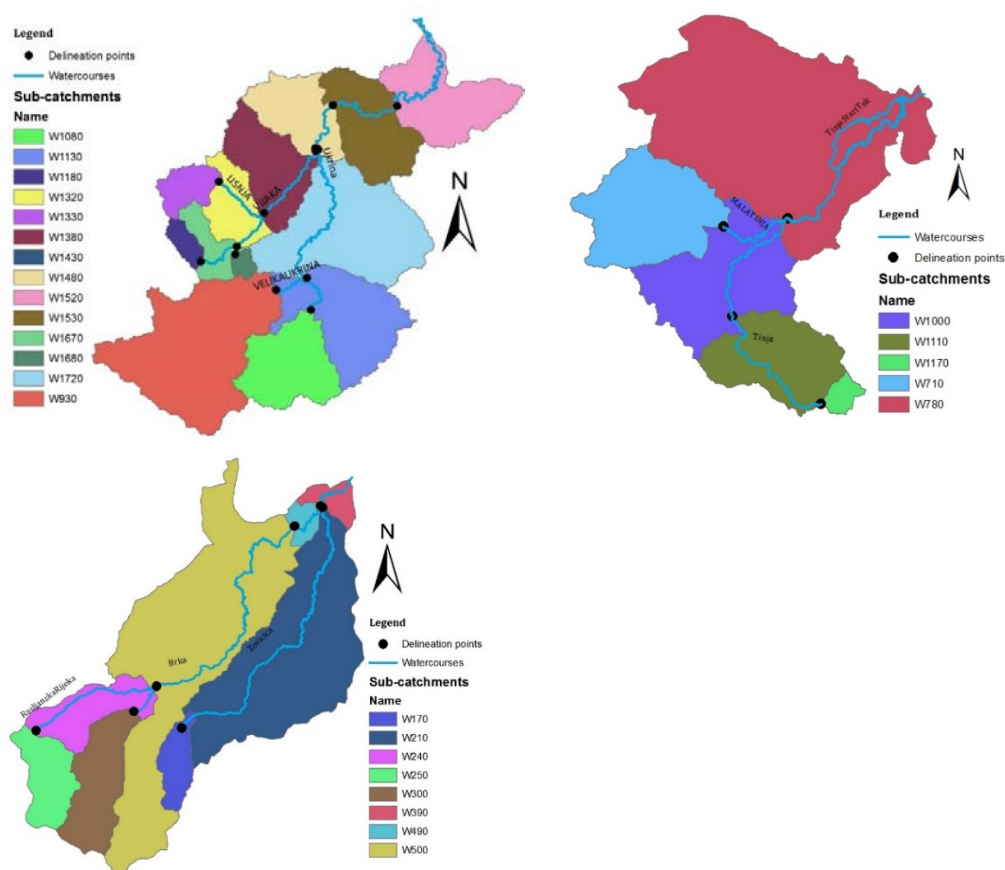

Figure 5. Division of Ukrina (upper left), Tinja (upper right) and Brka (down left) into sub-catchments in NAM [14]

According to data available, period for calibration and validation is only 2008-2014, where 2008 is a warm-up year. General recommendation for calibration length is at least 5 years, so calibration period is 2008-2013, while year 2014 is used for model validation (validation of results in the independent year outside the calibration period).

To calibrate ungauged basins, their behavior in terms of runoff generation mechanism is transferred from gauged catchments by means of regionalization process. In this process, catchment similarity plays great role assuming that nearby catchments behave in hydrologically similar way. The basic approach in catchment similarity is spatial proximity that emerges from the assumption that rainfall-runoff relationship varies smoothly in place or are uniform in the specific (predefined) region. Some studies [17] showed that spatial proximity yields much better prediction results in ungauged basins than with any other catchment characteristic, while best results are obtained by combining spatial proximity approach and catchment attributes, which is applied here.

In this study, several catchment's attributes are chosen for regionalization of optimized parameters in the Bosna River basin sub-catchments: (a) catchment area, (b) average catchment slope, (c) drainage length (sum of all watercourses on the basin), (d) density of drainage length (drainage

length divided with basin area), (e) forest coverage, (f) mean index of drainage density (GIS tool line density, density of linear feature in the neighborhood of each output raster cell [18]), (g) catchment shape length, (h) catchment shape (difference between min and max basin elevation divided with area) and (i) percent of basin under hypsometric curve between two elevations (for example 450-500 m.a.s.l.).

Regression is based on these catchment attributes and optimized parameter sets for the Bosna River sub-catchments. Prior to that, pool of sub-catchments is grouped by their similarity according to each attribute.

After hydrological model parameter determination, general simulation results are checked upon regional relative flow duration curves (presented as ratio to mean flow) constructed of available data from the hydrological stations on Bosna River Basin. At the end, modeling results are verified using available proxy site data. For this purpose, additional spatial data that were available are areas under potential significant flood risk (APSFR) and maximum inundation zones along the Ukrina river based on 2010 flood. The latter one is used for models' re-calibration.

With all of above, general framework for setting up the RR model for ungauged basins consists of following steps:

- Collect data from the nearby catchments,
- Extract catchment similarity indices, both for donor catchments (from which parameters will be transferred) and ungauged catchments,
- Calibration of the similar gauged catchments,
- Regression analysis, i.e., correlation between each optimized model parameter and catchment characteristic,
- Estimation of ungauged model parameters from the regression model (choosing only the one with strong correlations),
- Assessment of simulation results with respect to regionalized runoff characteristics (flow duration curves) and proxy data,
- Fine-tuning of parameter estimates to produce simulations consistent with the regionalized runoff characteristics,
- Validation of coupled hydrological and hydraulic model with additional parameter fine-tuning.

It is clear that results of sensitivity analysis are dependent of the analyzed basin. Since no data are available for the Ukrina and Brka basins, sensitivity analysis could not be performed. To overcome the potential issue of having different sensitive parameters for different basins, correlation between all NAM parameters and all basins are analyzed before final conclusion. If some of the insensitive NAM parameters (according to performed sensitivity analysis) show significant correlation with some of the catchment characteristics, it will be employed in the calibration procedure.

4.2. HYDRAULIC MODELLING

The quasi 2D approach is applied to simulate unsteady flow along Ukrina, Tinja and Brka rivers. Numerous river branches and consequently link channels along with several type of boundary and interior conditions, are used to simulate a complex flow pattern during the flood events. In this paper, only few key aspects of hydrodynamic modelling using quasi 2D approach implemented in MIKE 11 models for Ukrina, Tinja and Brka are presented.

In Figure 6, small portion of computational domain of Ukrina river that covers the town of Derventa is shown. Several branches are connected with link channels (blue lines with arrows at the one end) to simulate flows in urban environment. The link channels connect the branches separated mainly by road embankments (also, it can be said that cross sections are separated). In that case, the link channels simulate flow over the embankments. The boundary with link channels can also represent high terrain or even bank lines in the absence of levees. Branches can be also "laterally" separated by fictional boundaries in the case of wide inundations to better predict inception of flooding.

As can be seen in Figure 6, branches are not only separated laterally. At the location of bridge embankments, floodplain centerlines are disconnected and longitudinal conveyance is omitted. It is clear that this method can be applied only if overtopping conditions are out of considerations. If overtopping occurs, interior boundary condition should be defined on the single branch to represent inline structures.



Figure 6. Elements of 1D model for Ukrina River in the city of Derventa (Flow-path centerlines, Cross-sections and Link channels)

One of the most challenging tasks in modelling process was to include the effects of Drenova reservoir (Drenova river – tributary of Ukrina river) on flood wave attenuation. Due to the fact that geometry of the reservoir was not available, fictitious cross section was created to resemble the Volume-Elevation curve of Drenova reservoir (Figure 7). The cross sections are defined on the standard (1D) river branch. It means that “full” 1D unsteady flow equations are applied for this portion of domain to simulate flood wave propagation along the reservoir.

The dam of Drenova reservoir is represented in the model with predefined Q-H relationship for its spillway and outlet structures. Therefore, structures are included in the model through one interior boundary condition meaning that two Q-H relationships for each structure are combined into one - single family of curves.

The NAM and hydrodynamic models are linked by defining input hydrographs computed in NAM model as inflows used in hydrodynamic models. The hydrographs are converted to uniformly distributed inflows along the river reaches. The input hydrographs used in Tinja model are shown in Figure 8.

At the downstream ends of Ukrina, Tinja and Brka rivers, stage hydrographs are defined. The water surface elevations at those locations are obtained by interpolating stages measured at corresponding gauging stations along the Sava River.

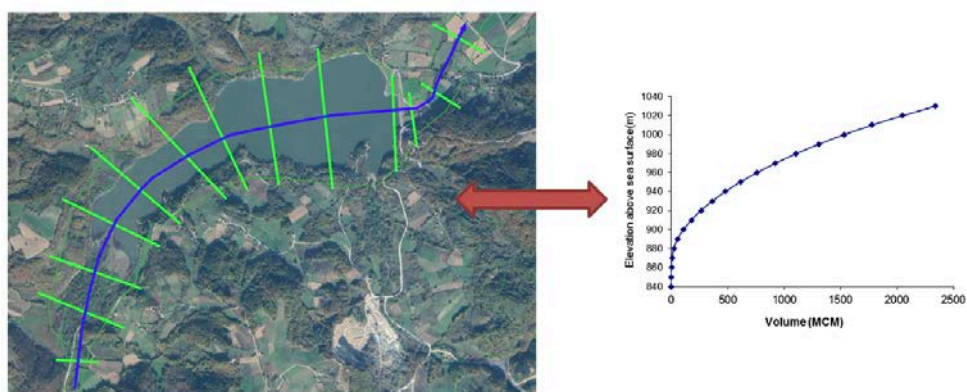

Figure 7. Cross-sections along the Drenova reservoir (left) and corresponding Volume-Elevation curve

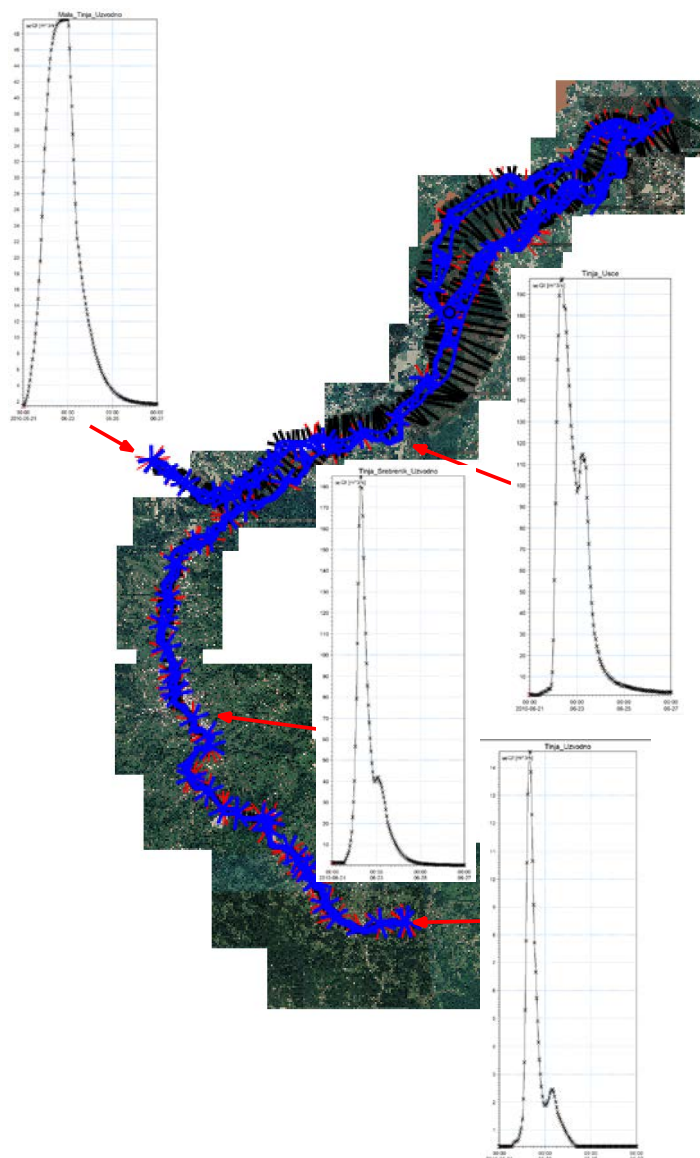

Figure 8. Hydrological inputs along the river network for Tinja River

5. APPLICATION IN UNGAGED BASINS – RESULTS AND DISCUSSION

5.1. HYDROLOGICAL MODEL SENSITIVITY ANALYSIS

Results of sensitivity analysis show that model output (assessed through model Kling-Gupta efficiency-KGE [19]) is highly dependent on CQOF, CK1 and CK2. Less sensitive are U_{\max} and L_{\max} while for TOF rapid change in model performance is observed when TOF value are higher than 0.5. This indicate that dominant processes in this particular catchment is related to overland flow (parameters CQOF, CK1 and TOF), partly interflow (parameter CK2) and upper soil storage water capacities (surface and root storage, parameters U_{\max} and L_{\max}).

The insensitive model parameters do not influence model performance and in the plot (not shown here) are characterized with the straight horizontal line which means that no efficiency change is made no matter which value parameter takes from the parameter space. Small sensitivity is observable to TG parameter, but only when its value is below 0.5. It seems that interflow, baseflow and groundwater component of water balance are not dominant processes for Tinja up to Srebrenik catchment.

5.2. REGIONALIZATION OF THE MIKE NAM PARAMETERS – MODEL CALIBRATION

Between optimized model parameters for all Bosna sub-catchments and all analyzed catchment characteristics, no correlations above 0.2 (which is very low and insignificant) was found. This was subject to further refinement of the catchment choice based on catchment similarity and particular catchment characteristic. This means that donor catchments that have quite different characteristic from the ungauged catchments were removed from the pool of catchments and correlations are analyzed again. This step is repeated for each characteristic individually.

Regarding catchment area, no significant correlations were found. For the average catchment slope, significant correlation is found only with CK1,2 parameter (timing constant for overland flow) including only 10 relatively low-land catchments with slopes between 6-15%. From this pool of catchment, ones with very small areas are removed and significantly better results are achieved. Correlation coefficient is 0.76 while regression model is two-degree polynomial, as shown on Figure 10, left. Somewhat weaker correlation is found between catchment drainage length and CQOF (overland flow coefficient) parameter, $R^2=0.66$. However, this parameter is highly correlated with the drainage density, as shown on Figure 9, right.

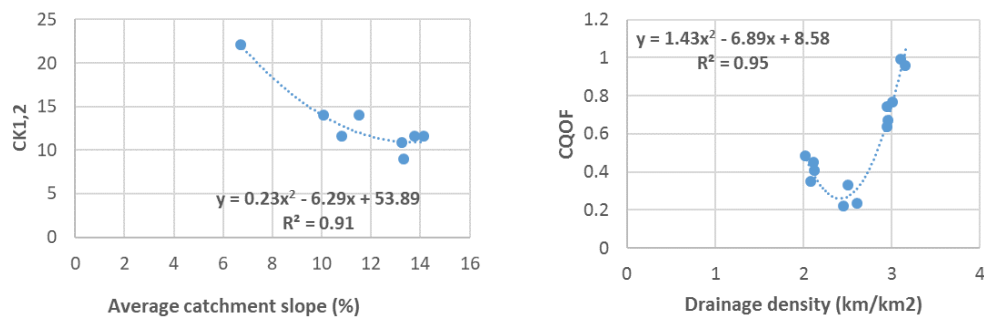

Figure 9. Regression models average catchment slope and $CK_{1,2}$ parameter

According to the percentage of forest coverage on catchments, 12 catchments was found similar to the ungauged catchments. As was expected, parameters related to the surface storage and root zone was correlated with this characteristic. Correlations are shown on Figure 10.

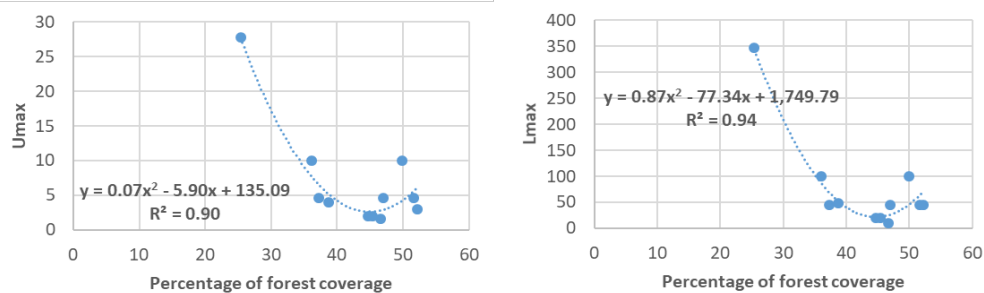

Figure 10. Regression models for forest coverage percentage and root zone model parameters

Parameter of threshold for overland flow TOF is correlated with the drainage density index, as shown on Figure 11.

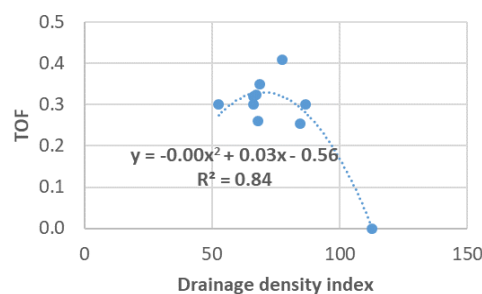

Figure 11. Regression model for drainage density index and TOF model parameter

In summary, all sensitive model parameters are explained (with their correlations) with some of the catchment characteristic. Insensitive parameters are not, which was expected, since their role in modelling process is of little important because they do not interfere with the model efficiency. This obviously is true for all Bosna sub-catchments, not only for gauged part of the Tinja catchment for which sensitivity analysis is performed.

From the analysis above, parameter values for ungauged basins and their sub-catchments can now be easily determined, knowing their characteristics employed in above regression models. However, in the situations where regional model gives irrational parameter values (for example, CQOF larger than 1, or L_{max} larger than recommended 300), values are kept at the maximum/minimum of the recommended parameter range.

5.2.1. Similar catchments and flow duration curves

After previous analysis, it became clear which catchments are similar by one or more characteristics with the ungauged catchments under this study. From the complete list of similar catchments, the ones with very small observation period (i.e., few years only, because of the bias of the optimized parameters values) and the ones with very small area (correlation analysis with catchment area showed that the results from the catchments smaller than 100km^2 deviate from the scatter the most) are removed. That left 18 sub-catchments from the Bosna River Basin to be used for validation of the models.

Figure 12 shows standardized (divided with mean flow) flow duration curves for the 18 catchments that are similar by its attributes with catchments Tinja ungauged part, Ukrina and Brka. On the plot, two curves are highlighted: the one for Tinja-Srebrenik sub-catchment obtained from observed flows (black dashed line) and one for Ukrina catchment up to Derventa station formed with historical observational data in period 1964-1983 (thick red line). From these FDCs, range is formed (showed as grey range on Figure 13) and used to validate results for sub-catchments of Ukrina, Tinja and Brka.

Results showed that modelled FDC are within the defined range of the regional FDC so there is no need for further refinement of model parameters (plots not shown here due to space limitation of the paper).

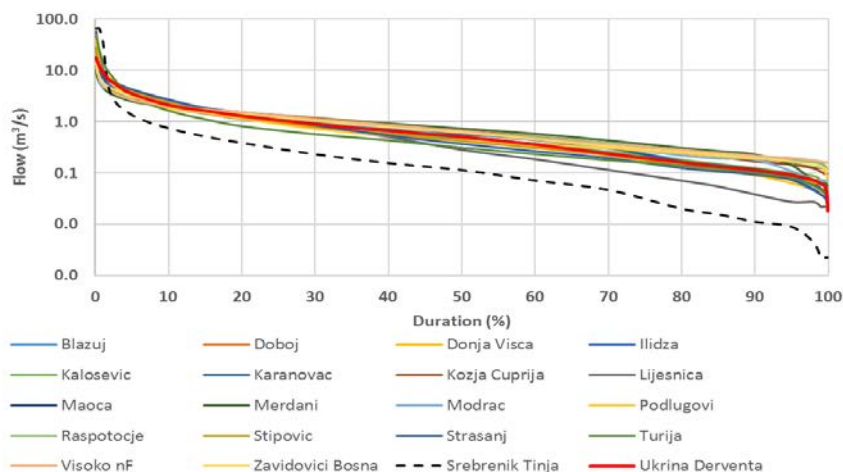

Figure 12. Relative flow duration curves (to mean flow) for the sub-catchments of Bosna River Basin that are similar to ungauged basins of Ukrina, Tinja and Brka

5.3. HYDRAULIC MODEL CALIBRATION

It was concluded that the most significant parameters of HD models for Tinja, Ukrina and Brka, beside the hydrological inputs, are Manning's coefficients and the parameters related to the link channels. Due to lack of available data that can be used to predict inception of flooding or lateral momentum and mass transfer between main river and floodplains, parameters of the link channels are estimated by expert judgment and only Manning's coefficients for regular branches (floodplains and main rivers) are subject to calibration.

The initial guess for Manning's coefficients is based on land cover data. Afterwards, the Manning's coefficients and inflows are varied until the historical APSFR boundaries and observed peaks of stage hydrographs were reproduced in numerical simulations of historical flood events.

Variation of adopted Resistance value (ratio between local and base value of Manning’s coefficient) across the one cross section of Ukrina river is depicted in Figure 13.

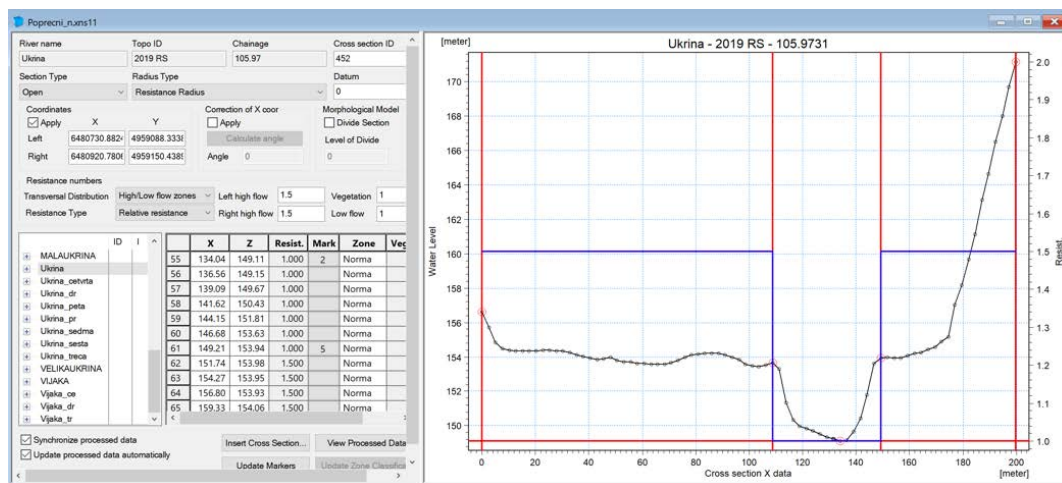

Figure 13. Variation of Resistance value across one cross section of Ukrina River

5.4. COUPLED HYDROLOGIC-HYDRAULIC MODEL RESULTS AND MODEL RE-CALIBRATION

The calibration (re-calibration) of coupled models is made through iterative process depicted in Figure 14. Parameters of previously calibrated NAM model are tuned in order to get satisfactory water levels according to historical flood zones from 2010 and known APSFR limits. The process is repeated in several iterations.

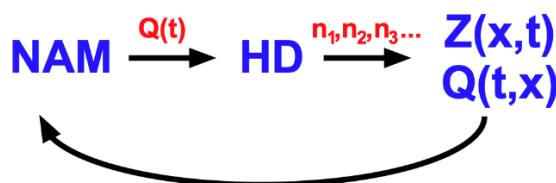

Figure 14. Scheme of re-calibration process of NAM and HD models

Validity of the runoff simulation is cross-referenced with the proxy data (recorded water level during 2010 flood that occur in the area of UTB basins). Hydraulic model run showed need for some of the sub-catchments parameters refinement in order to increase runoffs. As previously stated, parameters that are the most influential to runoff increase are CQOF and $CK_{1,2}$ and L_{max} to some extent. Therefore, these parameters are fine-tuned for all sub-catchments located downstream of the HS Srebrenik of Tinja basin until simulated water levels are closer to the extent of the APFSR.

Upon results of the hydraulic models and known data from Drenova reservoir during the 2010 flood as well as APFSR extent, water levels should be higher in the areas of Ukrina River tributaries Vijaka and Lišnja. Therefore, CQOF, $CK_{1,2}$ and L_{max} parameters of these sub-catchments are also tuned so to meet the recorded 2010 flood extent. For Brka basin, small increase of high flows was also needed.

With these new parameters, resulting FDC are compared with regional range. Modelled FDC again show good matching with regional ones, especially in the range of high flows, which is extremely important due to purpose of the hydrological model results. Figure 15 shows those results for Ukrina sub-catchments.

In Figure 16 the comparison between calculated and observed hydrographs at location of Srebrenik gauging station is shown for different phases (iterations from a) to d)) of calibration process. As explained earlier, both NAM and HD models are tuned to obtain satisfactory results. Compliance with second criteria for calibration is being checked by visual comparison of APSFR limits and calculated flood zones. In Figure 17 calculated flood zones for final step of calibration process are shown.

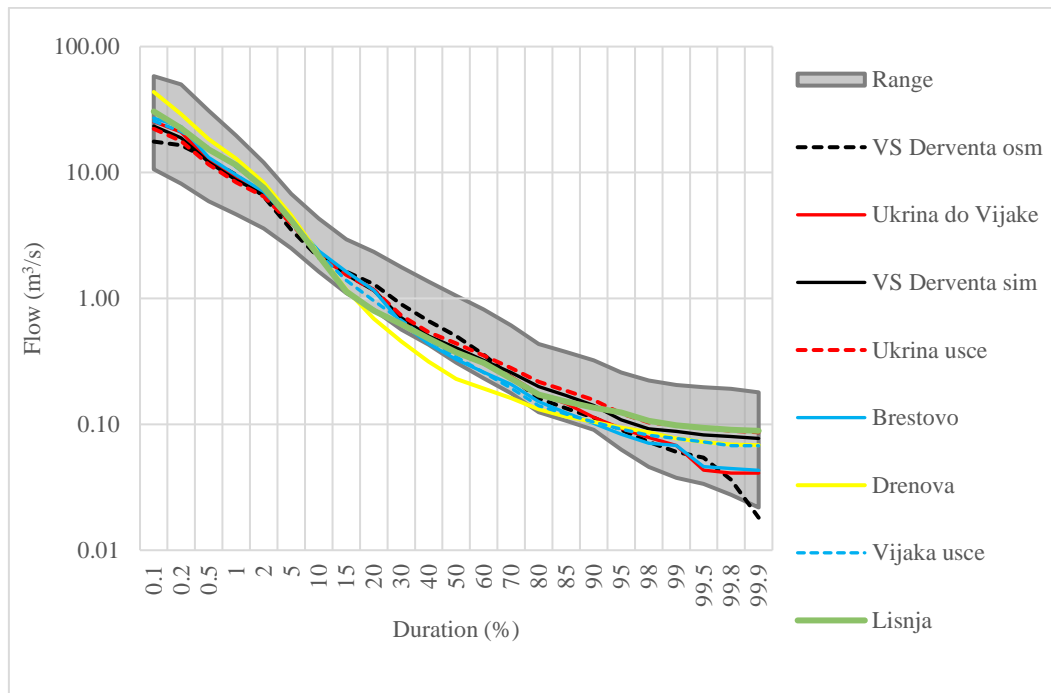

Figure 15. Comparison of flow duration curves from gauged catchments (grey range) and simulated for Ukrina model sub-catchments

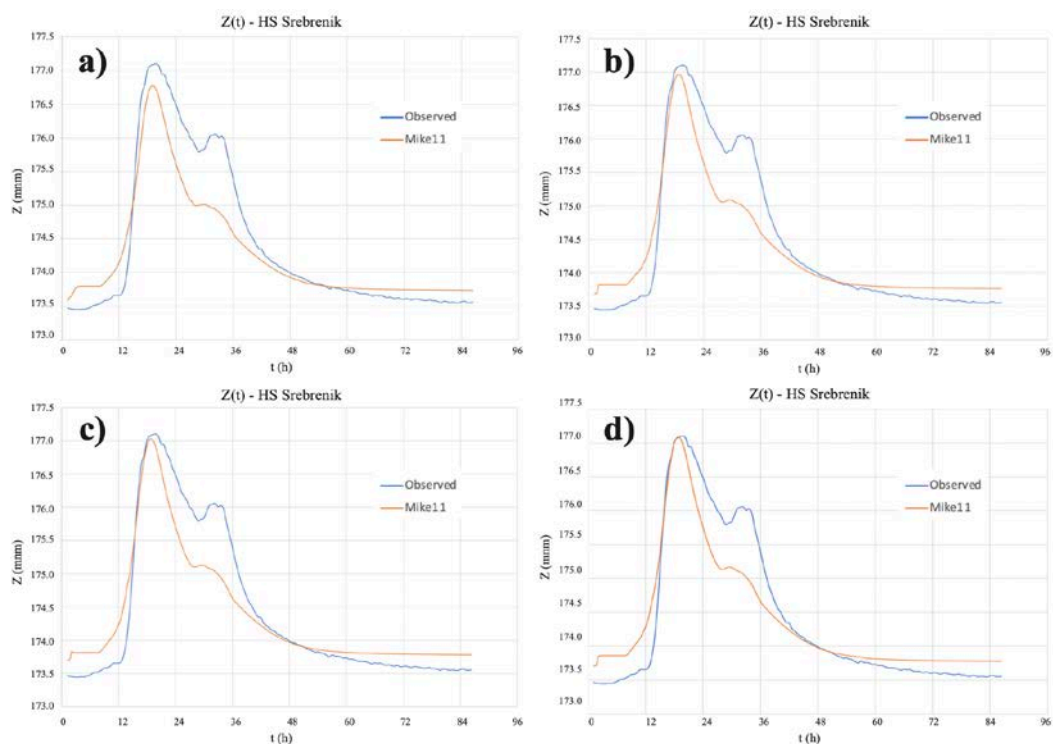

Figure 16. Comparison of calculated (orange line) and observed (blue line) stage hydrographs for different phases of re-calibration process



Figure 17. Calculated flood zones (areas filled with various colors) and APSFR limits (red lines) for Tinja River

6. CONCLUSIONS

In this study, methodology for hydrological and hydraulic modeling of ungauged basins that can be used in flood forecasting and early warning systems is presented. Due to lack of observed data on the basins, hydrological model is calibrated using regionalized regression models established between calibrated model parameters on nearby Bosna River sub-catchments and distinctive catchment characteristics, while parameters of the hydrodynamic model are assumed by expert judgement. Validation of the methodology was possible with historical areas under potential significant flood risk observed during the flood in 2010.

With applied methodology, it is observed that simulations of coupled hydrological and hydraulic models somewhat underestimated flood peaks on Ukrina, Tinja and Brka Rivers. The discrepancy in simulations could not be considered as error per se, since the simulations are compared to only one historical flood event. However, flood underestimation is consistent for all subbasins. The validation would be better if several floods were available, since flood mechanism varies from event to event due to storm characteristics and antecedent soil wetness, above other factors.

In general, proposed methodology proved to be worth of future development and upgrading. One of the upgrades to the proposed methods are further and in more detail exploration of catchments similarity in regression analysis in order to improve model's parameter estimation. Also, models validation should be extended to more flood events and with the results of flood forecasting system that operates in real-time in order to detailly validate the proposed methodology.

LITERATURE

- [1] J. Masters, "Earth's 40 Billion-Dollar Weather Disasters of 2019: 4th Most Billion-Dollar Events on Record," 2022. <https://blogs.scientificamerican.com/eye-of-the-storm/earths-40-billion-dollar-weather-disasters-of-2019-4th-most-billion-dollar-events-on-record/> (accessed Feb. 21, 2022).
- [2] J. Thielen-del Pozo *et al.*, *The benefit of continental flood early warning systems to reduce the impact of flood disasters*, no. April 2016. 2015.
- [3] G. L. Vandewiele, C. Y. Xu, and W. Huybrechts, "Regionalisation of physically-based water balance models in Belgium. Application to ungauged catchments," *Water Resour. Manag.*, vol. 5, no. 3–4, pp. 199–208, 1991, doi: 10.1007/BF00421989.

- [4] D. H. Burn and D. B. Boorman, "Estimation of hydrological parameters at ungauged catchments," *J. Hydrol.*, vol. 143, no. 3–4, pp. 429–454, 1993, doi: 10.1016/0022-1694(93)90203-L.
- [5] L. Oudin, V. Andréassian, C. Perrin, C. Michel, and N. Le Moine, "Spatial proximity, physical similarity, regression and ungauged catchments: A comparison of regionalization approaches based on 913 French catchments," *Water Resour. Res.*, vol. 44, no. 3, p. n/a-n/a, 2008, doi: 10.1029/2007WR006240.
- [6] B. Sivakumar, V. P. Singh, R. Berndtsson, and S. K. Khan, "Catchment Classification Framework in Hydrology: Challenges and Directions," *J. Hydrol. Eng.*, no. 2, p. 130426211354007, 2013, doi: 10.1061/(ASCE)HE.1943-5584.0000837.
- [7] X. Kong, Z. Li, and Z. Liu, "Flood Prediction in Ungauged Basins by Physical-Based TOPKAPI Model," *Adv. Meteorol.*, vol. 2019, 2019, doi: 10.1155/2019/4795853.
- [8] S. A. Nielsen and E. Hansen, "Numerical Simulation of the Rainfall Runoff Process on a Daily Basis," *Nord. Hydrol.*, vol. 4, pp. 171–190, 1973.
- [9] DHI, "NAM manual." 2014.
- [10] Zavod za Vodoprivredu d.o.o. Bijeljina, "Izrada mapa opasnosti i mapa rizika od poplava na slivu rijeke Vrbas u BiH - Pregled i analiza hidroloških podataka i razvoj hidroloških modela," Banja Luka, Bijeljina, Sarajevo, Beograd, 2016.
- [11] DHI, "MIKE 11 - A modelling system for rivers and channels," *Reference manual*. DHI, 2009.
- [12] DHI, "MIKE: A modelling system for Rivers and Channels - User guide," *User Guide*. 2017, [Online]. Available: <http://10.0.46.73/zrzyxb.20160781%0Ahttps://search.ebscohost.com/login.aspx?direct=true&db=a9h&AN=125384783&site=ehost-live&scope=site>.
- [13] J. Berko, "Flood plain modelling," 2014. <https://www.slideserve.com/jamal/flood-plain-modelling>.
- [14] EPTISA Servicios de Ingenieria S.L., "Technical assistance for development of the hydrological flood forecasting system for Sava River Basin (Phase 1. Bosna River)," Sarajevo-Banja Luka, 2019.
- [15] H. Madsen, "Automatic calibration of a conceptual rainfall–runoff model using multiple objectives," *J. Hydrol.*, vol. 235, no. 3, pp. 276–288, 2000, doi: 10.1016/S0022-1694(00)00279-1.
- [16] J. A. Vrugt, H. V. Gupta, W. Bouten, and S. Sorooshian, "A Shuffled Complex Evolution Metropolis algorithm for optimization and uncertainty assessment of hydrologic model parameters," *Water Resour. Res.*, vol. 39, no. 8, 2003, doi: 10.1029/2002WR001642.
- [17] R. Merz and G. Blöschl, "Flood frequency regionalisation—spatial proximity vs. catchment attributes," *J. Hydrol.*, vol. 302, no. 1–4, pp. 283–306, 2005.
- [18] ESRI, "How line density works." http://resources.esri.com/help/9.3/arcgisdesktop/com/gp_toolref/spatial_analyst_tools/how_line_density_works.htm.
- [19] H. V. Gupta, H. Kling, K. K. Yilmaz, and G. F. Martinez, "Decomposition of the mean squared error and NSE performance criteria: Implications for improving hydrological modelling," *J. Hydrol.*, vol. 377, no. 1–2, pp. 80–91, 2009, doi:10.1016/j.jhydrol.2009.08.003.



Borislava Blagojević, Univeristy of Niš, borislava.blagojevic@gaf.ni.ac.rs
Žana Topalović, University of Banja Luka, zana.topalovic@aggf.unibl.org
Petar Praštalo, University of Banja Luka, petar.prastalo@aggf.unibl.org

COMPARATIVE ANALYSIS OF AN UNGAUGED BASIN MODELLING RESULTS BY THREE CONCEPTUAL HYDROLOGICAL MODELS

Abstract

The hydrometeorological data availability is the main issue for hydrological modeling, especially pronounced in ungauged basins. The research presented in the paper attempts at overcoming the data availability issue by applying three different hydrological models, and observing the most acceptable basin response from an ungauged basin. The calibration and validation of models is performed on flow duration curves from nearby gauged catchments, and the agreement of simulated and 'observed' flows is compared visually and quantitatively for characteristic flows. An annual distribution of monthly to mean flow ratio is also observed. The best performing model is HBV light, although the studied annual flow ratio and the ratio pattern cannot be achieved by any of the applied models in the periods of calibration and validation.

Keywords: Flow duration curve, ungauged basin, HEC-HMS, HBV light, GRJ4.

UPOREDNA ANALIZA REZULTATA MODELIRANJA NEIZUČENOG SLIVA POMOĆU TRI KONCEPTUALNA HIDOLOŠKA MODELA

Сажетак

Расположивост хидрометеоролошких података је један од главних проблема у хидролошком моделирању, нарочито на хидролошки неизученим сливовима. Истраживање представљено у овом чланку има за циљ да превазиђе проблем расположивости података употребом три различита хидролошка модела и уочавањем најприхватљивијег одговора неизученог слива. Калибрација и валидација модела је извршена коришћењем кривих трајања протока формираних из података околних изучених сливова. Слагање симулираних и постојећих кривих трајања је оцијењено визуелним прегледом и квантитативно за карактеристичне протоке са криве трајања. Унутаргодишња расподела односа мјесечних и средњих протока је такође анализирана. ХБВ лигхт модел даје најбоље резултате иако однос мјесечних и средњих годишњих протока као и њихова унутаргодишња расподела није добро репродукована ни са једним моделом у периодима калибрације и валидације модела.

Кључне ријечи: криве трајања протока, неизучен слив, HEC-HMS, HBV light, GRJ4.

1. INTRODUCTION

Hydrological modeling as a scientific discipline is introduced in the 1960s. Hydrological models provide insight to the temporal and spatial variability of water resources essential for a variety of water-related fields including effective management of these resources, and preventing risk disasters. Transformation of precipitation into runoff is a complex natural process per se, therefore demanding for hydrological modeling. Simulating runoff and/or assessing flows has always been a key task in hydrology, especially in the hydrologically ungauged basins where statistical methods cannot be applied due to the absence of flow observation data [1]. Besides the lack of runoff data in the desired period or absence of these data at all, another modelling issue is insufficient quality of the runoff data that can be present in the gauged catchments. Such a situation increases already existing uncertainty of modelling both in the model calibration and validation periods. One of the questions regarding calibration (and validation) strategy is: What should be the main object of calibration?

Costa et al. [2] performed the parameter calibration of the large basin model consisting of several smaller catchments, having flow duration curves (FDCs) as the main object of calibration. The research goal was production of the ranked flows through a set of parameters, regardless of runoff serial structure. Through the evolution of rainfall and evaporation over the simulation period, this structure is retrieved indirectly. This approach reduces regionalization to the FDC parameters.

By using the HBV runoff model that only requires daily temperature, precipitation and monthly potential evaporation as input, Pool et al. [3] investigated the choice of a sampling strategy for individual runoff measurements when taken at strategic points in time during one year. They have found that FDCs were generally better simulated when strategies captured low and mean flows.

The approach Westenberg et al. [4] used for regionalization of FDCs accounted for runoff and input-output data uncertainties in FDC and rainfall-runoff model regionalization, while Westenberg et al. [5] developed a new calibration method using FDCs. The method addresses issues found in calibration with traditional performance measures such as the Nash-Sutcliffe model efficiency.

The research goal in this paper is to find out which model structure can be considered an appropriate hypothesis of the mean daily flows in an ungauged catchment through calibrating a hydrological model, as recommended in [5]. The object of calibration is FDC, while indirect validation also includes reproducing an annual distribution of monthly to mean flow ratio.

The motivation for the research is a demand for a water reservoir operation management plan in an ungauged basin in a poor data environment, emphasized by the data gap typical in Bosnia and Herzegovina for the period 1991-2000 and later.

2. METHODOLOGY

2.1. HYDROLOGICAL SIMULATION MODELS

Three hydrological models for continuous hydrological simulations were used in this research: HEC-HMS, HBV light and GR4J.

The HEC-HMS model is primarily intended for modeling runoff from isolated rainfall episodes such as design storms, but also allows for continuous hydrological simulations [6]. It consists of several components intended for modeling effective precipitation, direct and base runoff and runoff transformation. In this research, two variants of HEC-HMS model were considered: model A, with snow in its structure in addition to the input data on precipitation, temperature and evapotranspiration. Model B has no snow in its structure, therefore it uses precipitation and evapotranspiration as the input data. A total of 8 parameters were used when calibrating the model. The HBV light model is based on the water balance equation [7]:

$$P - E - Q = \frac{d}{dt}(SP + SM + UZ + LZ + lakes) \quad (1)$$

where P – precipitation [mm], E - evapotranspiration [mm], Q – runoff [mm/day], SP – snow pack [-], SM – soil moisture [mm], UZ – upper groundwater zone [mm], LZ – lower groundwater zone [mm], lakes – lake volume [-].

The model simulates daily discharge using daily rainfall, temperature and potential evaporation as input. A total of 19 parameters were used when calibrating the model [8], [9].

The GR4J model is a water balance hydrological model with four parameters developed by Perrin et al. [10]. It is an empirical model but its structure is similar to the conceptual models. It takes into account the humidity and contains two reservoirs (production and routing). Unit hydrographs are also associated with the hydrological behavior of the basin.

Figure 1 shows the structure of the hydrological models used.

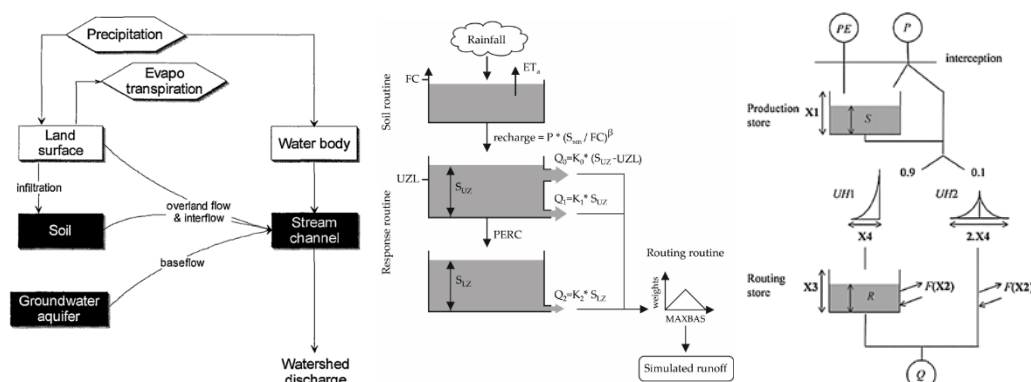

Figure 1. Structure of hydrological model: HEC-HMS (left) [7], HBV light (center) [9], GR4J (right) [10]

2.2. THE STUDIED CATCHMENT AND INPUT DATA

The Drenova Reservoir was established by the construction of the Drenova concrete dam on the river Vijaka, the largest left tributary of the Ukrina river, a direct right tributary of the Sava River. The research treated the catchment area up to the location of the Drenova dam, with a basin area of 68 km². The elevation range of the catchment is from 161 m above sea level (masl) at the dam location and 594 masl at the highest catchment point. The hydrographic river network comprises of four small rivers: Vijaka, Topolova, Lišnja and Drenovica with their tributaries [11].

The main river is the Vijaka river, 14 km long with an average slope of 1.25%. The catchment is considered hydrologically ungauged basin, regardless of the short period of flow and precipitation observations in the vicinity, due to unreliable hydrological data for the Vijaka river [12].

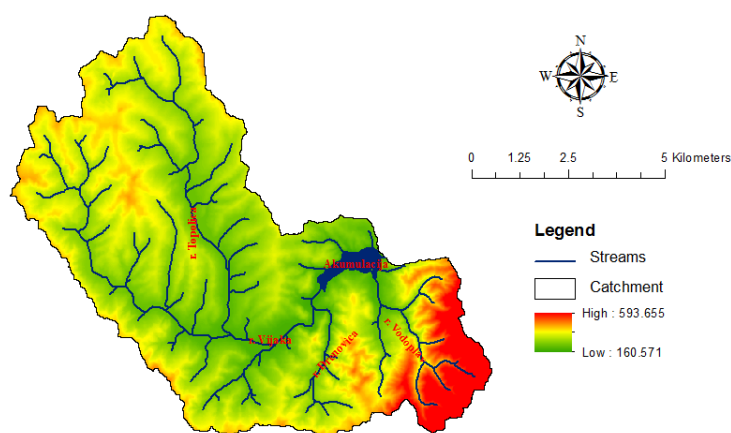

Figure 2. Digital elevation model (DEM) and river network of the studied Drenova catchment [11]

Data on daily precipitation and air temperatures from the meteorological station (MS) Banja Luka were used as input data for hydrological modeling of the Drenova dam basin, according to the spatial analysis results where MS Banja Luka, MS Doboje and MS Slavonski Brod were considered [11].

In the HEC-HMS and HBV light models, a monthly evapotranspiration is assessed by the Thornthwaite method, while in the GR4J model, daily evapotranspiration input data is determined by the Hamon method.

The time step for all hydrological models is one day.

2.3. CALIBRATION OF MODEL PARAMETERS

The choice of strategy for calibration of model parameters and validation of simulation results is complex when it comes to gauged basins. Usually split-sample test (SST) [13] is used to determine period for calibration on which model is trained and period of validation (different from calibration period) on which model will be tested in means of capability to simulate runoff outside of the training period. Nowadays, calibration is performed using some of the many automatic optimization

algorithms which exclude subjectivity incorporated in the process of manual calibration and recommended use of more than one calibration criteria [14], [15].

For ungauged basins, a special model calibration and verification strategies are used. The basic strategy, also applied here, is the division of the available observed data period into periods for model calibration and verification, and using a dimensionless flow duration curve (FDC) instead of flows. A FDC formulated in this way, links the ratio of the characteristic flows of a given duration to the mean annual flow.

To obtain the dimensionless FDCs at the Drenova ungauged basin in the calibration and verification periods (Figure 3), FDCs from the eight hydrological stations (HS) are averaged. The obtained two dimensionless FDCs are considered the reference FDCs for the Drenova ungauged catchment. In the HS selection process, the main criterion is hydrometeorological data availability, while other criteria are data completeness, the catchment area and the distance (as crow flies) from the Drenova catchment, as shown in Table 1. In Figure 4, the map of selected HS and MS is presented.

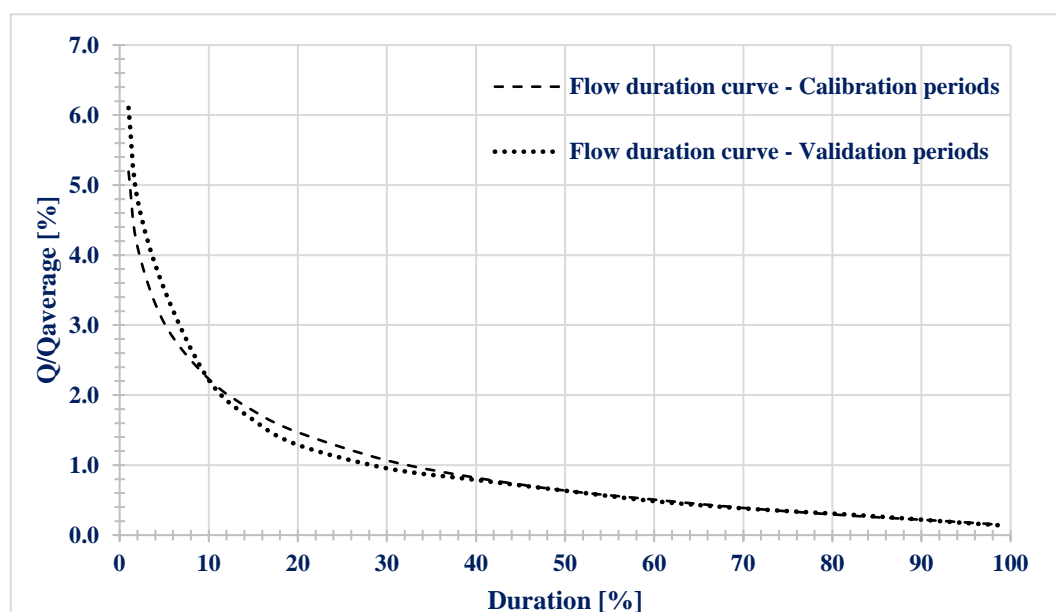

Figure 3. The reference dimensionless averaged FDC in the model calibration and validation periods [11], [16]

Table 1. The set of HS used for calibration and validation of the Drenova basin model [16]

No.	HS	River	Area [km ²]	Available data records	Distance from Drenova [km]
1	Hrustovo	Sanica	348	1966-1990; 2006-2008	74
2	Rmanj Manastir	Unac	1010	1961-1990; 2007-2008	125
3	Blažuj	Zujevina	155	1966-1990; 2006-2008	118
4	Dobrinje	Bosna	2677	1961-1990	93
5	Kalošević	Usora	633	1961-1990; 2006-2009	27
6	Karanovac	Spreča	1828	1961-1990; 2006-2008	52
7	Merdani	Lašva	950	1961-1990; 2006-2008	80
8	Modrac	Spreča	1176	1961-1990; 2006	77

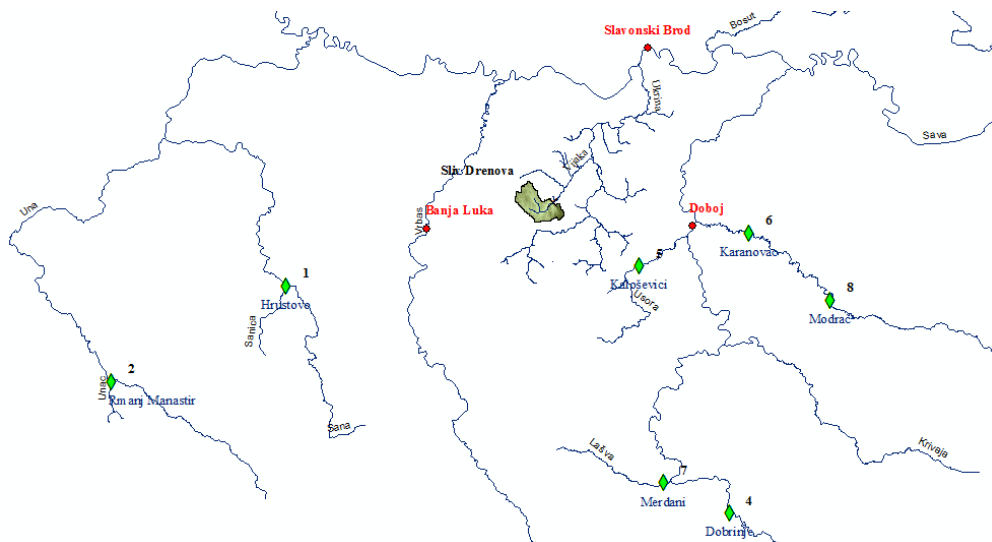

Figure 4. Location of the Drenova catchment, meteorological stations (red circles), and hydrological stations (green diamonds) used for calibration and validation [16]

3. RESULTS AND DISCUSSION

3.1. FLOW SIMULATION BY THE THREE MODELS

The daily flows simulated by the three studied models is shown in Figure 5 for one year. In this year, HBV light model exhibits the highest flow responses to precipitation, GR4J the lowest, while HEC-HMS model A with snow, results in higher flows than model B without snow.

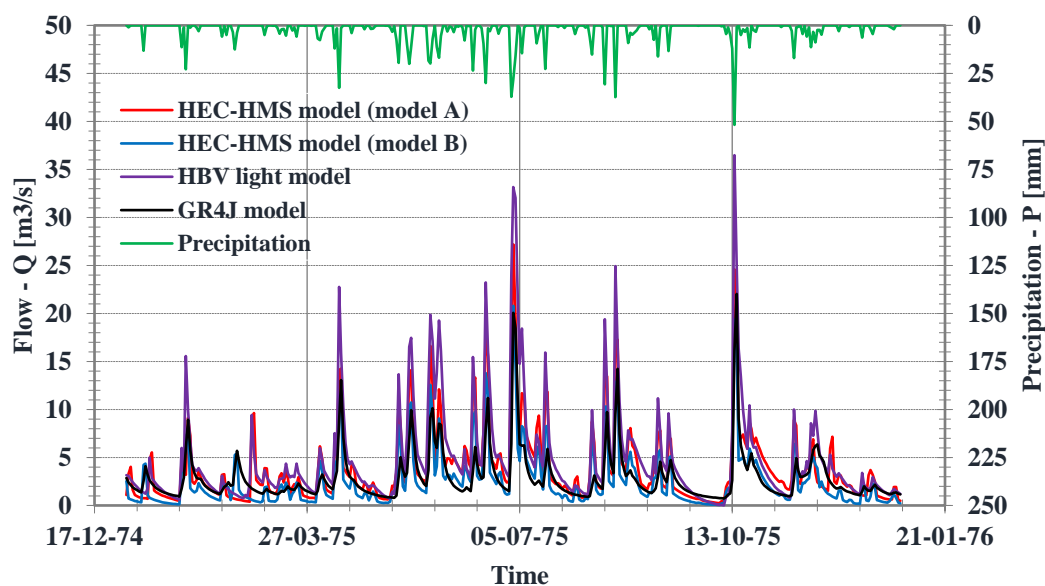

Figure 5. Simulation results for the year 1975 in the calibration period

3.2. FLOW DURATION CURVES IN CALIBRATION AND VALIDATION PERIODS

The reference dimensionless FDCs used for calibration (Figure 6) and validation (Figure 7) are shown with the achieved FDCs generated from the modelling results. These two sets of FDCs behave differently in the calibration and validation periods, i.e. their shifts compared to the reference FDC are more pronounced in the flood to mean flow range durations (<30%) in the validation compared to calibration periods. In the mean to low flow durations (>50%), the gap between FDCs is similar in these two periods.

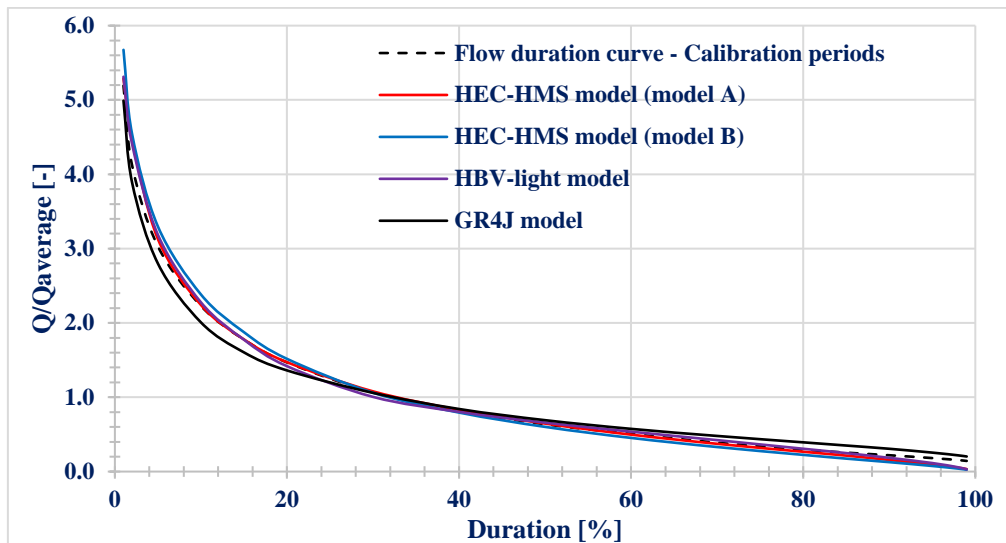

Figure 6. The reference FDC and FDCs generated from flow modelling results in the calibration periods

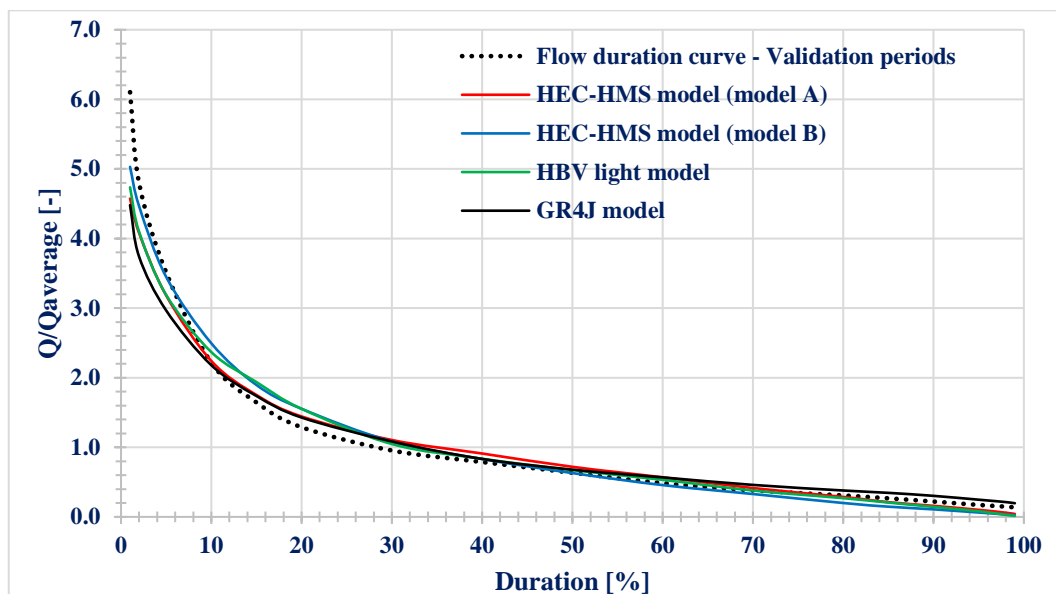

Figure 7. Observed and simulation FDC and FDC for validation periods

The fit between the reference FDC and the simulated FDC was determined for six characteristic durations: 1, 5, 30, 50, 70 and 95%. The absolute errors per model and duration are shown in Table 2.

In the model calibration period:

- HEC-HMS model (model A) is the best fit for durations of 1%, 5%, 50% and 70%, while HBV light is the second best;
- HEC-HMS model (model B) and GR4J are best fit for the duration of 30%;
- HBV light model is best fit for the duration of 95% where GR4J is the second best.

In the model validation period:

- HEC-HMS model (model B) is the best fit for durations of 1%, 5% and 50%, while HBV light is the second best for all durations but 30% and 70%, where it is the best performing model.
- HEC-HMS model (model A) is the best fit for duration 95%.

Overall, HBV light is the best performing model, ranked first in the validation, and second in the calibration period.

Table 2. Absolute error of the dimensionless FDCs for characteristic durations

Periods	Duration	HEC-HMS model (model A)	HEC-HMS model (model B)	HBV light model	GR4J model
Calibration (1961-1990)	1%	0.096	0.482	0.120	0.202
	5%	0.099	0.267	0.155	0.231
	30%	0.012	0.007	0.062	0.008
	50%	0.010	0.035	0.022	0.055
	70%	0.015	0.058	0.035	0.091
	95%	0.086	0.106	0.067	0.074
Validation (2005-2008)	1%	1.529	1.073	1.368	1.624
	5%	0.333	0.065	0.324	0.548
	30%	0.151	0.128	0.093	0.130
	50%	0.085	0.005	0.039	0.044
	70%	0.033	0.053	0.002	0.078
	95%	0.071	0.109	0.091	0.075

3.3. ANNUAL FLOW DISTRIBUTION

The ability of models to replicate flow dynamics is assessed in this research via the annual flow distribution. Again, the ratio of monthly to mean annual flow is considered, but for calendar months. This merely visual comparison of annual flow patterns is done for the set of diagrams constructed for the HS used for generating the Drenova ungauged basin reference FDC, and HSs on the direct river Sava tributaries in BiH. The source of the latter background diagram is the analysis of water balance of Republika Srpska [12].

3.3.1. Annual flow distribution in calibration period

The annual distribution of runoff is similar in the HS shown in Figure 8, when it comes to the periods of high and low flow, except for the river Spreča and the river Unac, where the wettest month is February. The results of the simulation in the HEC-HMS package for model A and model B, indicate that the model is not able to reproduce the annual distribution of runoff both in the terms of dynamics and flow variability [16]. The same stands for the HBV light and the GR4J model in the calibration period, although HBV light model shows better variation in runoff between the high and low water periods, compared to the other models.

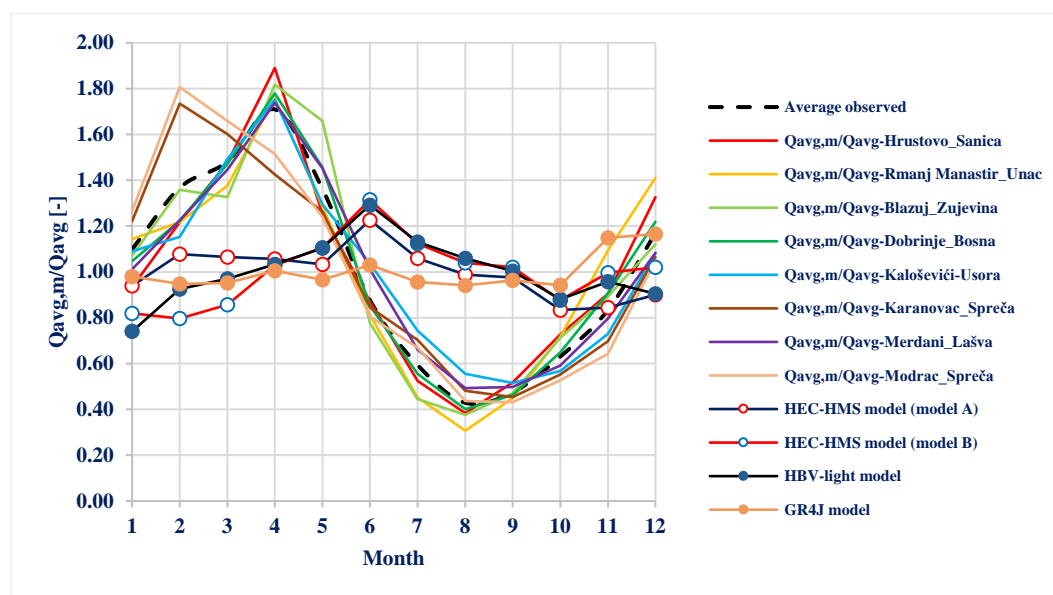

Figure 8. Calibration period: Annual flow variability at HS used for model calibration and variability achieved by modelling the ungauged catchment of the Drenova

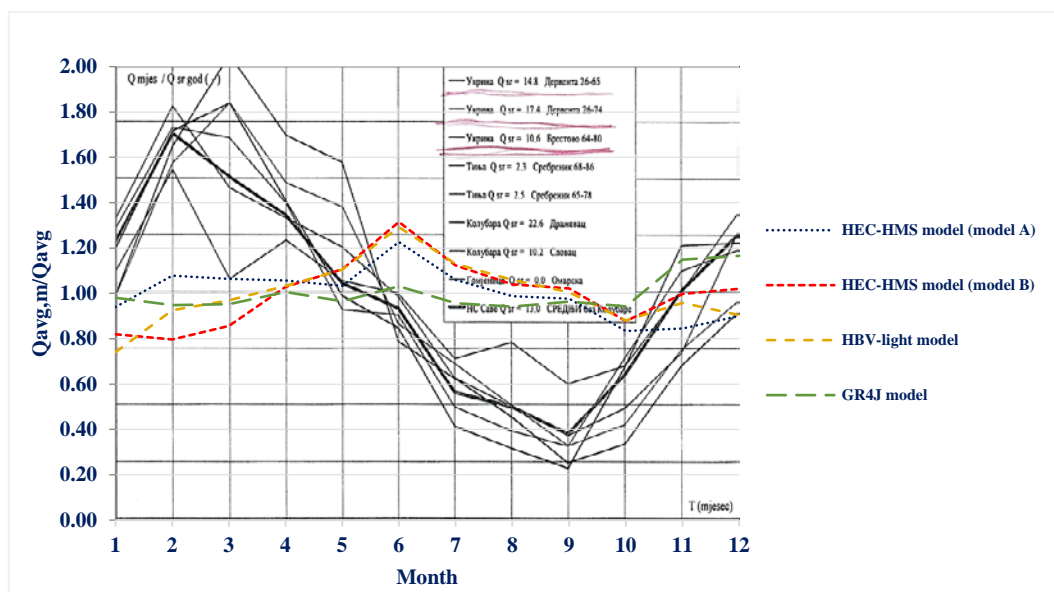

Figure 9. Calibration period: Annual flow variability for the direct tributaries to the river Sava [12] and variability achieved by modelling the ungauged catchment of the Drenova

A more pronounced differences are found in the comparison with the immediate Sava River tributaries in Figure 9 for the calibration period. The diagram shows the dimensionless annual flow distribution in the river basins of the rivers Ukrina, Tinja and Gomjenica, and the HS in the Kolubara river in Serbia. The applied models were not able to produce flows that would lead to a realistic annual distribution both in the period of flood and low flows and the variability of flows. GR4J model performs worst in both comparisons shown in Figure 8 and Figure 9.

3.3.2. Annual flow distribution in validation period

The dimensionless annual flow distribution diagram achieved by the three investigated models in the river Drenova catchment is plotted on the corresponding diagrams shown in Figure 10 and Figure 11. The validation period of three years (2006-2008) used for validation of FDCs is short for reliable insight to annual flow distribution. Therefore, the diagrams are used to observe if models are able to produce any variability in annual flow distribution, and match periods of high and low flows.

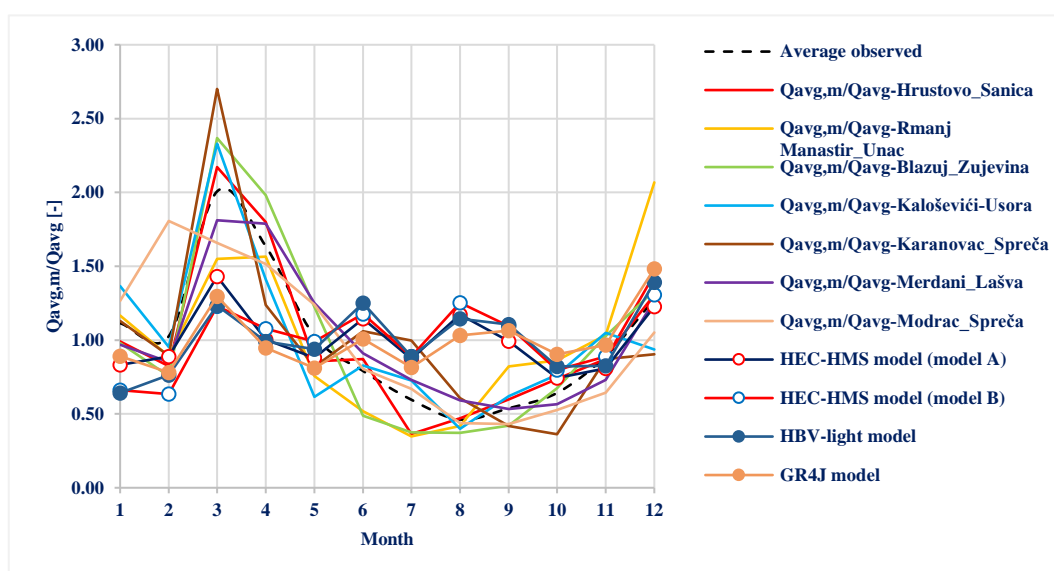

Figure 10. Validation period: Annual flow variability at HS used for model calibration and variability achieved by modelling the ungauged catchment of the Drenova in the same period

The obtained variability of monthly flows is better in the validation period in all models compared to the calibration period. All of them exhibit primary maximum in March, that corresponds to general behavior of HSs shown in Figure 10. The months of June, August and September in the river

Drenova catchment show higher flows than expected in the validation period by all models. A similar situation is in comparison to the direct tributaries to the river Sava, shown in Figure 11: The most noticeable mismatch appears in the low flow period August-September where modelled flows point out to the secondary flow maximum. Such a case is most pronounced for the GRJ4 model according to timing.

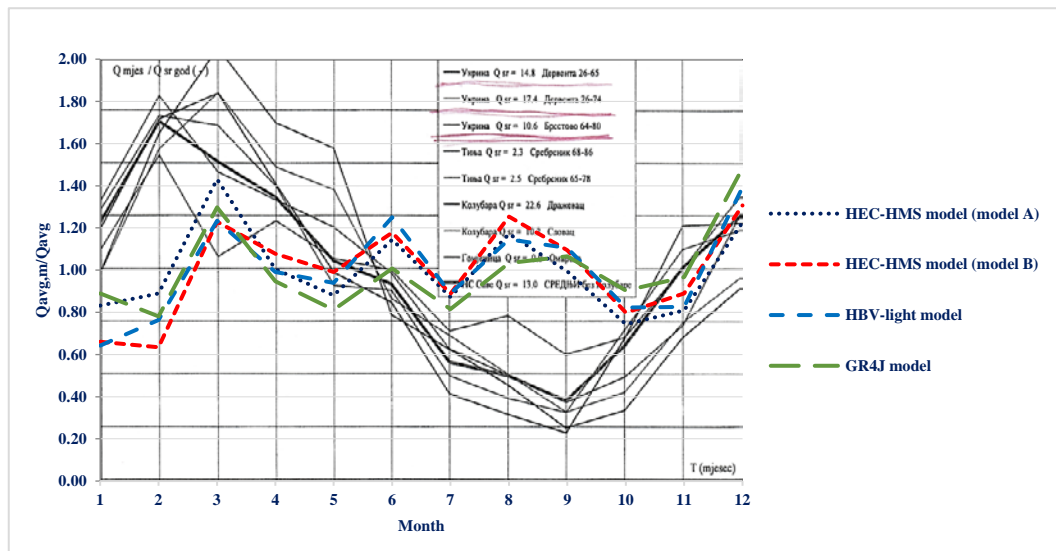

Figure 11. Annual flow variability for the direct tributaries to the river Sava [12] and variability achieved by modelling the ungauged catchment of the Drenova in the validation period

3.3.3. Annual flow distribution in the climatic data availability period

The best performing model according to the dimensionless FDC replicability, HBV light, is used here in posterior analysis to test the model adequacy for daily simulations in longer period. While flow gauge records at HSs were available for two separate periods with the data gap between the years 1991 and 2005 (Table 1), daily precipitation and air temperature data from the MS Banja Luka were available without gaps. A monthly evapotranspiration required for input data in HBV light model is assessed by the Thornthwaite method.

The red line in Figure 12 shows annual flow variability obtained by processing daily flow simulation results of the HBV light model in the period 1961-2008. Both flow variability and line shape resemble the pattern shown at the locations in closest proximity to the Drenova river catchment.

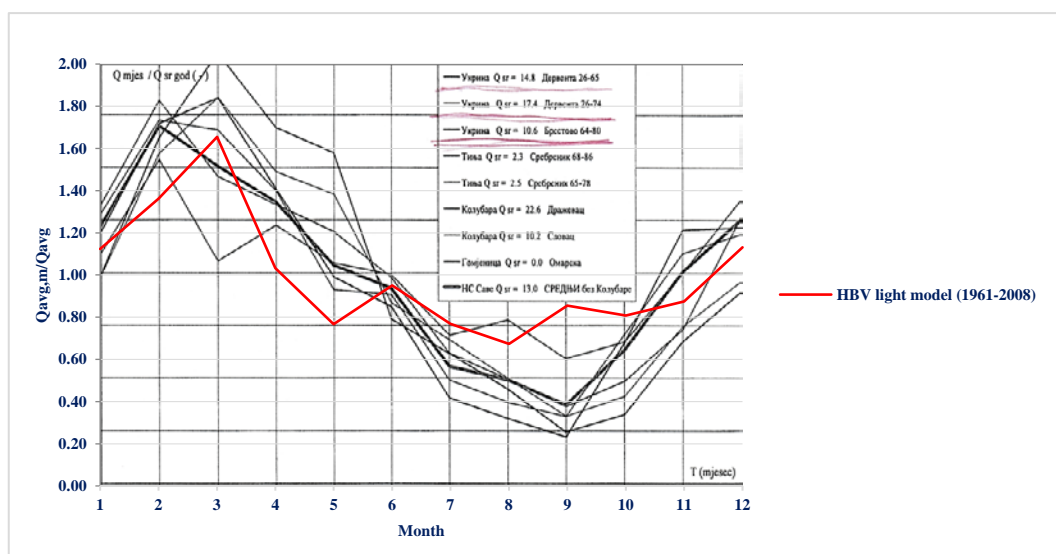

Figure 12. Annual flow variability for the direct tributaries to the river Sava [12] and variability achieved by modelling the ungauged catchment of the Drenova in the period 1961-2008

The thick black line denoting averaged annual flow distribution in the direct right tributaries to the river Sava in BiH only (in the river basins of the Ukrina, Tinja and Gomjenica river) shows the

situation prior to the year 1980 in different sampling periods, ranging from 14 to 50 years. It is not known if there were record gaps and in general, there is a question regarding the quality of runoff data in previous period. It is also not possible to differentiate lines by colour between catchment locations in the original diagram [12] for more detailed analysis. Nevertheless, the results achieved by the HBV light model daily flow simulations for this long period are generally acceptable in all annual periods but for the month of May where it seem underestimated, and in the low flow period (August and September), potentially overestimated.

4. CONCLUSION

The paper investigates the potential for calibrating and verifying three hydrological models for simulation of daily flows using dimensionless FDCs. The prevailing calibration and verification periods are uneven: 30 years (1961-1990) for calibration and 3 years (2006-2008) for the verification period. Among the hydrological models, HEC-HMS models with snow (model A) and without snow (model B) have 8 parameters each, HBV light model 19 parameters and the GR4J model 4 parameters. Both HBV light and GR4J model are applied without snow in their structure.

Based on the flow simulation results by the three models for the studied Drenova ungauged basin, the following may be concluded:

1. According to the fit of six characteristic duration flows of the FDCs, the HEC-HMS model A with snow and HBV light perform better in the calibration period, while in the validation period, HBV light as well as HEC-HMS model B without snow perform well.
2. In the calibration and validation periods, annual flow pattern is not matched by any of the models both in the terms of dynamics and flow range. However, simulations by the HBV light model in the longer period (1961-2008) show significantly improved annual flow pattern when calibrated model is run on the fully available sets of climatic data.
3. The best performing model overall is the HBV light, the model with the most parameters, while the worst performing is GRJ, with the least parameters. The GRJ model has shown poor results in the similar input data environment [17].
4. When modelling ungauged catchments, it is recommended that at least two different models are used for better perception of simulation results. The HEC-HMS model A with snow is also worth further consideration according to the results of this research.
5. Models calibrated by the FDCs should undergo additional testing of the simulation results. One of possible means of the result verification shown in this research is by the achieved annual flow pattern, while some authors focus on reproducing the observed flow frequency distribution rather than the exact hydrograph [5].
6. Using the three present models with different calibration strategies/objects (e.g. using other flow characteristics beside FDC) might produce different results in the terms of model adequacy for ungauged catchments.

The recommendation for future research is to spatially extend the set of HSs for generating FDCs to the locations in broader region, and include HSs that would have a longer or at least even period for calibration and validation of the models. The catchment similarity should also be checked beyond homogeneity presumption based on proximity and catchment area range.

Regarding the HBV light model, further improvement of the catchment representation should be considered by increasing the number of elevation zones and subcatchments. The HEC-HMS model A with snow should also be considered in the future research. The structure of these two models seems the most appropriate in the studied case.

LITERATURE

- [1] A. Petroselli, A. Mulaomerović-Šeta, and Ž. Lozančić, "Usporedba metodologija za određivanje velikih voda na odabranim slivovima u Bosni i Hercegovini," vol. 71. pp. 729–738, 2019.
- [2] V. Costa, W. Fernandes, and M. Naghettini, "Regional models of flow-duration curves of perennial and intermittent streams and their use for calibrating the parameters of a rainfall-runoff model". *Hydrological Processes*, 59 (2), 262–277, 2014.
- [3] S. Pool, D. Viviroli, and J. Seibert, "Prediction of hydrographs and flow-duration curves in almost ungauged catchments: Which runoff measurements are most informative for model calibration?" *Journal of Hydrology*, 554, 613–622, 2017.

- [4] I.K. Westerberg, L. Gong, K. Beven, J. Seibert, A. Semedo, C.-Y. Xu, and S. Halldin, "Regional water-balance modelling using flow-duration curves with observational uncertainties". *Hydrology and Earth System Sciences*, 18 (1), 2993–3013, 2014.
- [5] Westerberg, I.K., Guerrero, J.L., Younger, P.M., Beven, K., Seibert, J., Halldin, S., Freer, J.E., and Xu, C.-Y., 2011. "Calibration of hydrological models using flow-duration curves". *Hydrology and Earth System Sciences*, 15 (7), 2205–2227, 2011.
- [6] A. Todorović and J. Plavšić, "Mogućnost primene modela HEC-HMS za kontinualne hidrološke simulacije," *Vodoprivreda*, vol. 46, no. 1–6, pp. 117–128, 2014.
- [7] J. Seibert, "HBV light," *HBV Light version 2 User's Man.*, no. November, 2005.
- [8] J. Seibert and M. J. P. Vis, "Teaching hydrological modeling with a user-friendly catchment-runoff-model software package," *Hydrol. Earth Syst. Sci.*, vol. 16, no. 9, pp. 3315–3325, 2012, doi: 10.5194/hess-16-3315-2012.
- [9] A. Foehn *et al.*, "RS MINERVE - User Manual," v2.15. *Ed. CREALP*, no. April, p. 124, 2020.
- [10] C. M. Munajat, I. K. Hadihardaja and D. Harlan, "The improvement of GR4J model parameter to estimate unit hydrograph". International Seminar on Advanced of Water Resources Management in a Global Challenge. Kupang – East Nusa Tenggara – Indonesia, November, 2019.
- [11] P. Praštalo, B. Blagojević, and Ž. Topalović, "Flow duration curves as a tool for calibration and verification of the HBV-light model in ungauged catchment," pp. 88–99, 2008.
- [12] Zavod za vodoprivredu (ZZV) (2011) *Analiza bilansa voda u Republici Srpskoj, Hidrološka studija*, Zavod za vodoprivredu d.o.o., Bijeljina
- [13] V. Klemeš, "Operational testing of hydrological simulation models," *Hydrol. Sci. J.*, vol. 31, no. 1, pp. 13–24, 1986, doi: 10.1080/02626668609491024.
- [14] H. V. Gupta, S. Sorooshian, and P. O. Yapo, "Toward improved calibration of hydrologic models: Multiple and noncommensurable measures of information," *Water Resour. Res.*, vol. 34, no. 4, pp. 751–763, 1998, doi: 10.1029/97WR03495.
- [15] P. O. Yapo, H. V. Gupta, and S. Sorooshian, "Multi-objective global optimization for hydrologic models," *J. Hydrol.*, vol. 204, pp. 83–97, 1998, doi: 10.1016/S0022-1694(97)00107-8.
- [16] P. Praštalo, Ž. Topalović and B. Blagojević, "Kalibracija i verifikacija HEC-HMS modela neizučenog sliva pomoću krivih trajanja proka, *Nauka i praksa*, vol 20. pp. 20–27, 2017.
- [17] P. Praštalo, Ž. Topalović and B. Blagojević, "Geomorfološki jedinični hidrogram kao alat u hidrološkom modelu za određivanje velikih voda na hidrološki neizučenim slivovima". Zbornik radova 19. Naučnog savetovanja Srpskog društva za hidraulička istraživanja (SDHI) i Srpskog društva za hidrologiju (SDH). Beograd, 18-19. oktobar 2021., Urednici: Jaćimović, N., Plavšić, J. Izdavač: Univerzitet u Beogradu - Građevinski fakultet, Beograd, 2021, ISBN 978-86-7518-219-1, p. 200-211, 2021



Georgios Chantzis, Aristotle University of Thessaloniki, chantzis@meng.auth.gr
Maria Symeonidou, Aristotle University of Thessaloniki, mmsymenonid@meng.auth.gr
Panagiota Antoniadou, Aristotle University of Thessaloniki, pantoniadou@meng.auth.gr
Effrosyni Giama, Aristotle University of Thessaloniki, fgiama@meng.auth.gr
Sofia-Natalia Boemi, Aristotle University of Thessaloniki, nboemi@meng.auth.gr
Stella Chadiarakou, FIBRAN S.A., Thessaloniki, Stellah@fibran.gr
Agis Papadopoulos, Aristotle University of Thessaloniki, agis@meng.auth.gr

ANALYSIS AND EVALUATION OF THE THERMOPHYSICAL PROPERTIES OF VENTILATED FAÇADE TYPOLOGIES

Abstract

The energy efficiency of the construction sector is denoted by the European energy and environmental policies, by international standards and national legislation. Ventilated facades can contribute towards more efficient buildings, hence this paper focuses on the evaluation of ventilated façade construction typologies and the impact of thermal radiance exposure. The selected scenarios were evaluated in terms of thermophysical analysis and laboratory measurements, and based on the results useful conclusions can be derived. Nevertheless, there is need of further investigation towards alternative configurations of the facades, such as implementing alternative ventilation configurations and patterns as well as more innovative and technical efficient construction materials.

Keywords: thermophysical analysis, ventilated façade, construction typologies, radiance exposure

АНАЛИЗА И ОЦЈЕНА ТЕРМОФИЗИЧКИХ СВОЈСТАВА ТИПОЛОГИЈА ВЕНТИЛИСАНИХ ФАСАДА

Сажетак

Енергетску ефикасност грађевинског сектора обиљежавају европска енергетска и еколошка политика, међународни стандарди и национално законодавство. Вентилисане фасаде могу допринијети ефикаснијим зградама, стога се овај рад фокусира на оцјену типологија слојева конструкције вентилисаних фасада и утицај изложености топлотном зрачењу. Одабране ситуације су процијењене у смислу термофизичке анализе и лабораторијских мјерења и на основу резултата се могу извести корисни закључци. Ипак, постоји потреба за даље истраживање у правцу алтернативних фасадних система, као што је имплементација алтернативних вентилационих система и шаблона, као и иновативнијих и технички ефикаснијих грађевинских материјала.

Кључне ријечи: термофизичка анализа, вентилисана фасада, типологије конструкција, изложеност зрачењу.

1. INTRODUCTION

The EU's energy and environmental strategy has set clear objectives for improving energy efficiency, reducing greenhouse gas emissions and fostering the use of renewable energy sources. The first goal of 20-20-20 has practically been achieved, and there are optimistic indications that the goals for 2030 will also be achieved, whilst there is the promising vision of a carbon neutral Europe by 2050 [1]. Nearly Zero Energy Buildings (nZEBs) are a pivotal instrument in that direction and in order to rise up to this challenge one has to utilize the full array of technologies: energy efficient building envelope elements, high efficiency heating, ventilation and air-conditioning systems, renewable energy systems and of course smart technologies and automations to run all these systems, along with smart metering. The use of automation and smart system technologies, in particular, proves a challenge and, at the same time, the only answer for achieving the goals of the energy strategy for buildings in the current building stock.

Effective thermal protection of the envelope is a prerequisite for efficiency, in order to prevent unwanted heat fluxes, while also managing the internal temperature and achieving efficient HVAC operation and building energy efficiency in the usage phase. This research focuses on the operation of ventilated facade building typologies in the presence of thermal radiation.

Finally, increasing the share of Renewable Energy Sources (RES) is necessary to meet the reduced requirements and lower CO₂ emissions, hence mitigating climate change. It goes without saying, that financial aid instruments are needed to help in implementing rules and regulations and achieving the goals stated, whilst taking into consideration social factors, affordability and maintenance of living standards should not be left out of sight [2].

A number of research studies [3] have been carried out on the thermophysical study of building sections in order to determine their influence on interior thermal comfort [4], performance [5], and even energy conservation [6]. In our situation, the key focus is their performance study in an in vitro experiment, employing heat radiation sources. In this line of approach, more research into the functioning of construction typologies will lead to a greater knowledge of them before they are implemented on the envelope of an existing building. Hence, the novelty of the paper is the assessment of the the impact of mechanical ventilation on the thermal response of the ventilated façade.

2. METHODOLOGY

The methodology focused on in vitro measurements considering the thermophysical parameters examined in a number of selected scenarios. The scenarios selected describe three ventilated facade construction typologies and the goal of the study is to evaluate their thermophysical characteristics. In order to evaluate the thermal response of the ventilated facade typologies, a wall was constructed in the laboratory which the various elements of the sections of the ventilated façade were mounted. The laboratory is in the Department of Civil Engineering of the Aristotle University of Thessaloniki. The laboratory is not heated or cooled, in order to have free floating temperature conditions. Thessaloniki has, according to Köppen-Geiger's climate classification, humid subtropical climate (Cfa) and semi-arid climate (BSk) [7], [8].

The under evaluation construction sections of the building envelope consist of brickwork, stone wool insulation and a variety of materials regarding the ventilated façade part (Fig. 1). The ventilated façade construction is presented in figure 1 and a short description of the sections is given on table 1. As far as it concerns the insulation, the thermal conductivity coefficient (λ) of stonewool, is 0.035 W/mK, and induced thermal resistance (R) for 5cm width of material is 1.4 m²K/W. The thickness of the insulation was determined so as to achieve optimal insulation for different building elements based on different climatic conditions.

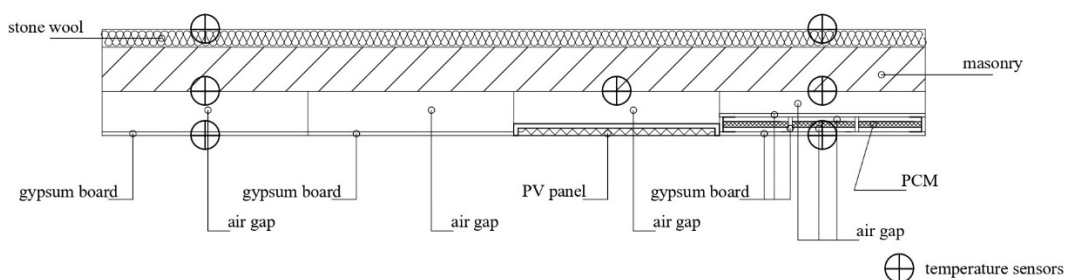

Figure 1. Floor plan of the under evaluation ventilated façade construction.

Table 1. Scenarios under thermophysical evaluation.

Scenarios	Description
Gypsum board section	Mineral wool insulation (5cm) and gypsum board façade
PV section	Mineral wool insulation (5cm) and PV panel mounted on façade
PCM section	Mineral wool insulation (5cm) and PCM sandwich on the external part of façade

3. CONSTRUCTION TYPOLOGIES' EVALUATION IN TERMS OF THERMOPHYSICAL ANALYSIS

The three different construction typologies are evaluated in terms of thermophysical analysis. Figure 2 presents the different typologies during the construction process and also the finished final configuration. Part of the experiment is using mechanical ventilation of the façade's cavity. For this purpose a cross flow fan is used (Figure 3) [9].



Figure 2. Presentation of under evaluation ventilated facade, (a) construction phase and (b) final configuration, PV mounted, radiation lamp and automation installed.



Figure 3. Cross flow fan under the PCM section.

The construction sections under evaluation are typical masonries with stone wool insulation and a width of insulating material of 5cm. The ventilated façade sections lay one next to another mounted on the same wall.

Based on their layer structure as presented in Fig. 2, the thermal transmittance values for the gypsum board and PCM façade sections were determined. The calculations were performed without considering the thermal conductivity of the air space, as there are not enough data in order to calculate it according to ISO 6946-2017 [10]. Ri and Ra are not considered either, as the experiment is conducted in an indoor space and air is practically stagnant. The phase change material used is the salt based inorganic PCM SP26E created by Rubitherm [11]. In table 2, are presented the lower U value is noted on the PCM facade construction section, while the gypsum board façade has a little higher U value.

In order to conduct the thermophysical analysis two HOBO UX120 data loggers were used to capture the surface temperatures of different parts of the under evaluation construction as indicated in figure 1 [12]. Moreover, the two out of three construction sections were exposed to a thermal radiation lamp of 1200 Watt. The part of the wall covered with the gypsum board was evaluated under a four days' schedule test, while the PCM section was evaluated according to a 3 days' schedule respectively. The schedule for each section is presented in table 3 and table 4 respectively. The construction section where the PV panel is mounted was not tested, because a large number of sensors and a different process is required for this type of evaluation. So, test schedule is not defined for the PV section and its thermophysical properties are not calculated, because the section was not directly tested. Still the temperature of every section during the testing period is presented.

Table 2. Ventiladed façade layers description and thermophysical characteristics.

Section	Layer	Thickness d [m]	Thermal Conductivity λ [W/mK]	U-Value [W/m ² K]
Plain gypsum board façade	Coating	0.02	0.9	0.537
	Rockwool	0.05	0.035	
	Masonry	0.15	0.45	
	Air space	0.15	Variable	
	Gypsum board	0.0125	0.225	
	Coating	0.02	0.9	
	Total	0.4025	-	
PCM façade	Coating	0.02	0.9	0.508
	Rockwool	0.05	0.035	
	Masonry	0.15	0.45	
	Air space	0.1125	Variable	
	Gypsum board	0.0125	0.225	
	Encapsulated PCM	0.025	0.5	
	Gypsum board	0.0125	0.225	
	Coating	0.02	0.9	
Total	0.4025	-		

Table 3. Operational schedule of thermophysical analysis of gypsum board section.

Section	Day 1		Day 2		Day 3		Day 4	
	Time	Lamp Operation	Time	Lamp Operation	Time	Lamp Operation	Time	Lamp Operation
Plain gypsum board facade	12.15	On	12.15	Off	12.15	Off	12.15	Off
			20.15	On				

Table 4. Operational schedule of thermophysical analysis of PCM section.

Section	Day 1		Day 2		Day 3	
	Time	Lamp Operation	Time	Lamp Operation	Time	Lamp Operation
PCM facade	14.10	On	14.10	On	22.10	Off
	22.10	Off	22.10	Off		

The operational schedule is separated into two parts: thermal charging and discharging, during which the thermal radiation lamp is turned on and off, respectively. The radiation lamp is positioned first in front of the gypsum board section according to a four-day schedule and then in front of the PCM section according to a three-day schedule. Also, the surface temperature sensors that monitor the front and back surface temperatures are moved to the corresponding section. For the gypsum board section, the adopted approach consists of a 24-hour circle of charging, then an 8-hour circle of discharging, a 16-hour circle of charging and a final 24-hour circle of discharging. For the PCM section an 8-hour circle of charging, then a 24-hour circle of discharging, an 8-hour circle of charging and a final 24-hour circle of discharging are applied respectively. During the first circle of charging of the PCM section the installed cross flow fan is in operation mode, while on the second cycle off charging it is powered off. Main goal of the applied schedules is the assessment of the thermal performance of the façade typologies under exposure to thermal radiation.

The conducted analysis in case of the gypsum board indicated (Figure 4) that during the 1st 24hours operation of the thermal radiation lamp, the temperature difference from for back surface and front surface reaches almost 8K with the front surface temperature ranges from 17.5°C to 18.1°C and the back surface temperature ranging from 9.5° C to 10.7° C. The surface temperature of the masonry in contact with the air space of the façade, is also presented for every section. Those surface temperatures constantly change and the temperature difference between those surface temperatures and the front surface temperature is constantly decreasing. The PV and gypsum board sections temperatures are almost reaching the front surface temperature at the end of the 24 hours (approximately 2K difference), while the PCM temperature is maintained at low levels and follows the trend of the back surface temperature line. During the second stage (8 hours on non-operation of the thermal radiation lamp) all the measured temperatures are similar varying from 10.8° C to 12.5 ° C. The 16-hour operation of the thermal radiation lamp and 24-hour non-operational day follow, with the same profile as the first 24-hour set and the first 8 hours on non-operation, respectively.

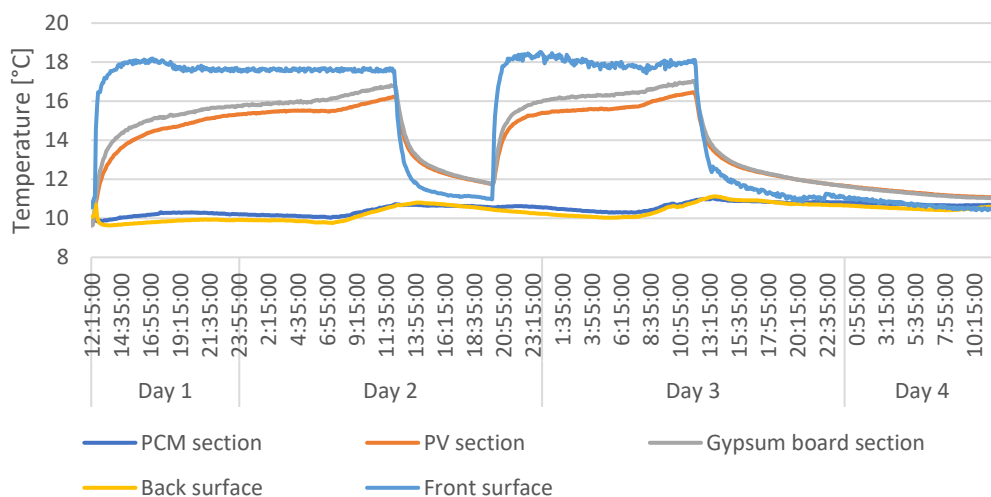

Figure 4. Analysis of experiment on gypsum board façade section.

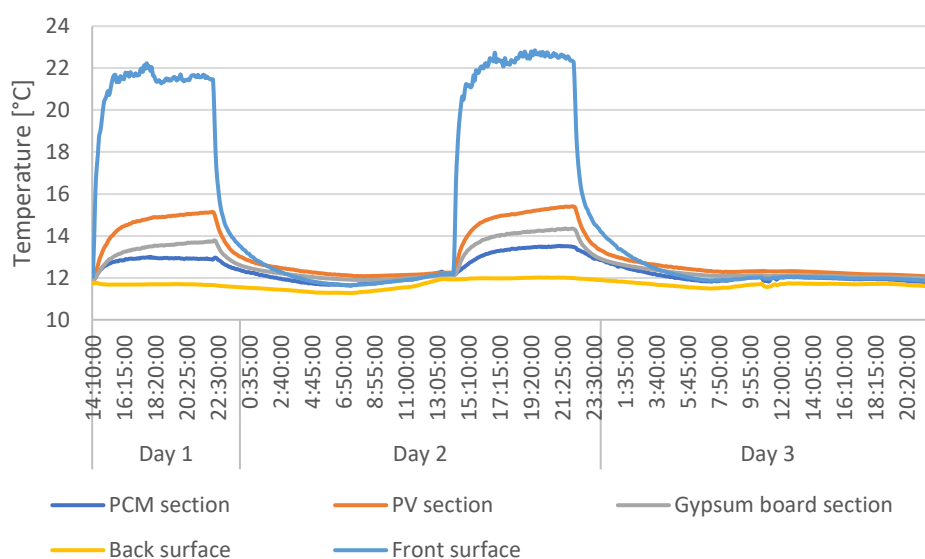

Figure 5. Analysis of experiment on PCM façade section.

The results of the experiment conducted on the PCM section indicate (Figure 5) that, during the 1st 8-hours operation of the thermal radiation lamp, the temperature difference between back and front surface reaches almost 10 K with the front surface temperature ranging from 21.2° C to 22.1° C and the back surface temperature ranging from 11.5° C to 12.1° C, respectively. For each segment, the surface temperature of the brickwork in contact with the air space of the façade is also shown. The difference in temperature between those surface temperatures and the front temperature is continually reducing as the surface temperatures fluctuate. The temperatures of the PV and gypsum board sections kept rising during the 8-hour period, reaching 14.9° C and 13.5° C, respectively. The temperature of the PCM part increases at the start of the 8-hour period and then nearly stays constant. The results for the other sections indicate that temperatures constantly change and the temperature difference between those surface temperatures and the front surface temperature is constantly decreasing. During the second stage (16 hours of non operation of the thermal radiation lamp) all the measured temperatures are similar varying from 11.7° C to 13.0° C. Following that is an 8-hour thermal radiation lamp operation and a 24-hour non-operational day, with the same profile as the first 8-hour set and the first 16 hours of non-operation, respectively. The results for the PCM section indicate (Figure 5) that during the 2nd 8hours operation of the thermal radiation lamp, the temperature continues to rise till 13.6° C, but still at smaller rates compared to the gypsum board and PV sections.

Comparing the results between mechanical ventilation on and mechanical ventilation off the temperature difference is relatively small. However, one can easily observe the stabilization of temperature that the mechanical ventilation offers.

4. CONCLUSIONS

The energy efficiency of buildings is still a major focus of EU energy and environmental policy. Furthermore, the Energy Performance of Buildings Directive's standards, in conjunction with progress toward new Nearly Zero-Energy Buildings (NZEB), establish measurable CO₂ emissions and energy efficiency targets. In the thermophysical investigation of the ventilated facade sections using thermal radiation sources, all of the sections under consideration respond to the high temperatures induced by the thermal radiation, recording temperature variations of up to 10 K. The study found significant difference on the performance of the PCM versus the gypsum board façade sections. Most specifically even though there is only slight difference between the U-value of the two sections, the PCM helps keeping both the ventilated cavity and the back surface of the wall at more stable low temperatures. Based on the findings of the measurements, more research into alternate facade layouts and ventilation patterns is required, in order to identify and better quantify the increase of the energy efficiency of the buildings that can be accomplished.

The installation and evaluation of such ventilated façade typologies in real buildings will be the subject of future research. According to the results of this research, ventilated facades might help

improve the performance of buildings by reducing the impact of high external temperatures in the Mediterranean area during the summer by charging the building envelope with reduced radiation and temperature loads. Those circumstances can help improve the structure's inside atmosphere, making it more pleasant and comfortable for the residents and even enhancing their productivity despite the hot Mediterranean summer. The influence of the energy profile improvement, on the other hand, should not be neglected, since combining the aforementioned typologies on a vented façade might reduce cooling loads and building energy consumption. Given the worldwide significance of the major study findings in terms of different climates, it's critical to establish the climatic factors and outdoor circumstances that influence energy consumption, environmental impact, and thermophysical characteristics of architectural typologies. Nonetheless, significant progress has been made in the construction sector, especially when we consider that, in addition to the severe economic recession, the construction sector has to deal with unexpected circumstances such as covid-19, which have an impact on the real economy and add to an already unstable economic framework. It is self-evident that, in addition to sustainability, construction should prioritize resilience by developing and implementing systems, materials, and structures that can adapt to vulnerabilities, catastrophes, and extreme events while also protecting users and providing consistency.

ACKNOWLEDGMENT

The authors would like to express their gratitude to the European Union and Greek national funds through the Operational Program for the co-finance of the program Intelligent Facades for Nearly Zero Energy Buildings (IF-ZEB) through the action Competitiveness, Entrepreneurship and Innovation, under the call RESEARCH-CREATE-INNOVATE (project code: T1EDK-02045).

LITERATURE

- [1] United Nations Environment Programme, "2021 Global Status Report for Buildings and Construction: Towards a Zero-emission, Efficient and Resilient Buildings and Construction Sector," Nairobi, 2021. [Online]. Available: www.globalabc.org.
- [2] E. Giama, E. Kyriaki, P. Fokaides, and A. M. Papadopoulos, "Energy policy towards nZEB: The Hellenic and Cypriot case," *Energy Sources, Part A Recover. Util. Environ. Eff.*, 2021, doi: 10.1080/15567036.2021.1892885.
- [3] A. M. Papadopoulos, "State of the art in thermal insulation materials and aims for future developments," *Energy Build.*, vol. 37, no. 1, pp. 77–86, Jan. 2005, doi: 10.1016/j.enbuild.2004.05.006.
- [4] A. Kumar and B. M. Suman, "Experimental evaluation of insulation materials for walls and roofs and their impact on indoor thermal comfort under composite climate," *Build. Environ.*, vol. 59, pp. 635–643, Jan. 2013, doi: 10.1016/j.buildenv.2012.09.023.
- [5] L. F. Cabeza, A. Castell, M. Medrano, I. Martorell, G. Pérez, and I. Fernández, "Experimental study on the performance of insulation materials in Mediterranean construction," *Energy Build.*, vol. 42, no. 5, pp. 630–636, May 2010, doi: 10.1016/j.enbuild.2009.10.033.
- [6] H. Huang et al., "Optimum insulation thicknesses and energy conservation of building thermal insulation materials in Chinese zone of humid subtropical climate," *Sustain. Cities Soc.*, vol. 52, Jan. 2020, doi: 10.1016/j.scs.2019.101840.
- [7] K. Leonidaki, E. Kyriaki, C. A. Konstantinidou, E. Giama, and A. M. Papadopoulos, "Thermal performance of office building envelopes: the role of window-to-wall ratio and thermal mass in Mediterranean and Oceanic climates," 2014. [Online]. Available: <https://www.researchgate.net/publication/275955363>.
- [8] M. Peel, B. Finlayson, and T. McMahon, "Updated World Map of the Koppen-Geiger Climate Classification," *Hydrol. Earth Syst. Sci. Discuss.*, vol. 4, Oct. 2007, doi: 10.5194/hess-11-1633-2007.
- [9] Fergas, "Crossflow/Tangential Blowers," 2022. <https://www.fergas.com/en/products/crossflow-tangential-blowers> (accessed Mar. 14, 2022).
- [10] ISO, ISO 6946: Building components and building elements-Thermal resistance and thermal transmittance-Calculation methods. 2017.
- [11] Rubitherm GmbH, "Inorganic PCM SP-line," 2022. <https://www.rubitherm.eu/en/index.php/productcategory/anorganische-pcm-sp> (accessed Mar. 13, 2022).
- [12] Onset, "HOBO 4-Channel Analog Data Logger UX120-006M | Onset Data Loggers," 2022. <https://www.onsetcomp.com/products/data-loggers/ux120-006m/> (accessed Mar. 04, 2022).



Nikola Miletić, University of Belgrade, nikola.miletic@arh.bg.ac.rs

Dušan Ignjatović, University of Belgrade, ignjatovic.dusan@arh.bg.ac.rs

Bojana Zevković, University of Belgrade, bojana@arh.bg.ac.rs

Nataša Ćuković Ignjatović, University of Belgrade, natasa@arh.bg.ac.rs

ENERGY EFFICIENT REFURBISHMENT OF MUNICIPAL PUBLIC BUILDINGS IN BELGRADE, SERBIA

Abstract

The paper presents the methodological approach for improvement of energy performance of public buildings in the process of partial refurbishment, having in mind the constraints that are originating from existing technological, material and stylistic characteristics. Being the carriers of wider social and historical connotations, these buildings are often under the certain level of protection as the parts of the cultural heritage making the process of improvement a complex one. For this reason, an improvement path algorithm has been defined and consequently tested on two representative cases investigating the boundaries, possibilities and outcomes of the energy refurbishment procedures.

Keywords: refurbishment, methodology, energy efficiency

ЕНЕРГЕТСКА ОБНОВА ЈАВНИХ ЗГРАДА - ГРАДСКИХ ОПШТИНА У БЕОГРАДУ, СРБИЈИ

Сажетак

Овај рад представља методолошки приступ унапређењу енергетских перформанси јавних зграда у процесу парцијалне обнове, узимајући у обзир ограничења условљена постојећим технолошким, материјалним и стилским карактеристикама зграде. Као носиоци ширих друштвених и историјских конотација, ови објекти су често под одређеним степеном заштите као културна добра, што процес њихове обнове чини веома комплексним. Из овог разлога, дефинисан је сет корака унапређења, који је потом тестиран на два репрезентативна случаја испитујући границе, могућности и исходе процеса енергетске санације објеката.

Кључне ријечи: обнова, методологија, енергетска ефикасност

1. INTRODUCTION

Existing public buildings are representing a specific portion of the building fund marked by high diversity in typological, structural and material characteristics as defined by the design principles and available technology of the time of construction. Many of these structures were not purposely designed for the function they now serve and have undergone various alterations and modifications which have largely changed their original state.

As they provide socially significant services, these buildings are frequently visited by the general public which presents a potential for a strategically different approach in the process of refurbishment - introducing not only the functional and technological elements into design process but also educational and demonstration ones. In that sense, these building represent a role-model for the people to see and other buildings to be like.

Starting from these considerations, process of refurbishment requires the specific case-sensitive approach, especially with the aim of improving the overall energy performance. Even more so when the considered building is under a certain level of heritage protection, which municipality buildings often are. Such an approach has previously been taken by researchers when considering energy efficient refurbishment of housing building stock built before 1919. in Serbia [1] and even considering of the most prominent public buildings in Belgrade from the aspect of energy refurbishment and constraints when buildings are under cultural heritage protection [2]. This paper, however, considers the constraints and possibilities in energy refurbishment process of a specific section of public buildings, that are the city municipality buildings, and offers findings gathered from conducting this process on two such buildings in Belgrade.

2. REFURBISHMENT METHODOLOGY

Methodology is developed in several main steps: initial investigation of the existing state, identification of individual improvement measures suitable for the specific case, formulation of improvement packages in accordance to the design conditions given by the institute for the protection of architectural heritage, valorization of different variants and production of design documentation. These main steps can be further divided into smaller steps in the following order:

- Data collection: architectural and other technical building data, on the basis of archival material, is collected and analyzed. Then, "In situ" research of building envelope's characteristics is performed by conducting an energy audit procedure. The thermal characteristics of the envelope are also determined by the method of thermal imaging of the building to see where the greatest energy losses are;
- Model formulation: a digital thermal model of the building is made by using Rhinoceros¹ 3D modeling software. The geometry of the building is divided into thermal zones, clearly distinguishing which zones and areas are heated, and which are not heated - such as basements, archives and technical rooms. Thermo-physical properties of the building are defined - structure of the envelope, parameters for natural ventilation, etc. The simple calculation of building physics is done in the program "KnaufTerm2 Pro"², which is a software package, intended for calculating the energy performance of buildings in accordance with applicable legislation in the Republic of Serbia, simulated for typical climatic conditions of Belgrade. The same model can be used for more complex, dynamic calculations, but they are not used, because they are not required by the current legislation.
- Assessment of possible energy efficiency and architectural measures in the scope of local construction practices, materials, financial feasibility and professional experience. Proposed measures need to take into account restrictions arising from the type, purpose and architectural characteristics of the building in terms of the need to preserve the existing condition and its architectural characteristics.
- Scenario definition: improvement scenarios were defined in three levels by incorporating energy efficiency measures in succession, starting from the same methodology that was used in previous research [3]. The first improvement scenario implies the improvement of the building for one energy class, for such is the obligation prescribed by the Rulebook on Conditions, Content and Method of Issuing Energy Performance Certificates [4] when refurbishing an existing building. The second level of improvement involves improvement of all thermal envelope elements to meet the standards (U_{max}) prescribed by the Rulebook

¹ Rhinoceros <https://www.rhino3d.com/>

² Knauf Insulation: <http://knaufinsulation.rs>

on Energy Efficiency in Buildings [5] and the third level of improvement includes maximal feasible improvement of the thermal envelope. Since this paper is based on real-life project, some modifications to this improvement methodology had to be made, in accordance to project task and existing situation. In first improvement, the most needed interventions and those easiest to carry out are implemented. In second improvement, parts of the thermal envelope that are difficult to access and/or have very small surface area and/or minimal impact on building's performance were not improved due to the cost of such works would outweigh the benefits. In all three improvement scenarios, individual elements of the thermal envelope have their thermal characteristics improved just to the point prescribed by the Rulebook [5] and not more. There is also a fourth improvement scenario which would be redesign - a total functional, structural and aesthetic overhaul of the building making it better suited for use in present time. This scenario however is not part of this paper.

- Simulation, calculation and valorization: determining the best scenario based on the analysis of energy required annually for heating, primary energy and total CO₂ emissions. When calculating the required energy, only the energy required for heating in the defined heating period, through the methodology of heating degree days (HDD) was taken into account, in accordance with the Serbia's Rulebook on energy efficiency of buildings [5]. The energy needed for lighting was not the topic of this study, or the energy needed to cool the building during the summer months, but as the proposed measures improve its thermal characteristics, it is assumed that the ratio of energy needed for cooling would be proportional to space heating, with minor changes due to higher solar gains.

Described methodology has been used in real case scenarios and has been finalized in the form of technical documentation required for the execution of the Energy refurbishment procedure of two Belgrade city's municipality buildings.

3. CASE STUDY

The case study consists of two buildings - Palilula municipality building and Zemun municipality building, which make a good basis for comparison on account their many similarities. Apart from the climate they share, both being located in Belgrade, Serbia, they are both public buildings, serving the same function of administrative, city municipality buildings. Although one was built at the end of nineteenth and the other in the middle of the twentieth century, they are made out of the same materials with very similar construction techniques and are roughly the same size. Both buildings have had multiple interventions during their exploitation in terms of their geometry and function - additional spaces have been added, attic spaces turned into offices, windows changed etc. They only differ in facade design as Zemun municipality building's street facade is treated in typical neo-classic style (See Figure 3) while Palilula municipality building, as an example of Belgrade's modern movement, has somewhat reduced ornamental expression (See 0).

3.1. PALILULA MUNICIPALITY BUILDING

3.1.1. Existing condition of the building

The building of the City Municipality of Palilula was built as an endowment according to the project made in 1938. After the abolition of the endowment in 1954, the building was nationalized and later turned into an administrative building. After the Second World War, an intervention was made in the form of adaptation of the attic into a useful office space, i.e. upgrades on the flat terraces of the courtyard, also in the form of office space.

The building has a basement, ground level and six floors, with its dominant axis being northeast - southwest, i.e. the courtyard part to the southeast. The yard part is uneven in relation to the street part and it has the same number of floors.

The building is built in a massive structural system with load-bearing masonry walls of various thicknesses and various brick formats, so that in the composition we find walls 51 cm, 38 cm and 25 cm thick, going from the basement level to the upper floors.

In the period after the Second World War, the building was upgraded with the addition of reinforced concrete slabs above the 6th floor (6th floor of the courtyard), above which a sloping wooden roof covered with sheet metal was constructed.

The street facade is characterized by relatively reduced facade plastic in the form of vertical grooves in the zones between the window openings and stone decorative slats around the windows and terraces in the central part of the facade canvas, i.e. distinctive texture made of artificial stone in the ground floor area. (See 0)

The existing windows are mostly made of PVC profiles and were installed in the early 2000s. During the exploitation, changes were made to the shape of the windows as well as their dimensions, so the current state is partially different from the original one. Although the existing PVC windows are in relatively good condition, they are, given their age, characterized by inadequate thermal characteristics, keeping in mind the current standards.

The building is supplied with thermal energy through a district heating system from the Public Utility Company of the Belgrade Power Plant using a radiator heating system. The radiator network is indented as not insulated within the thermal envelope of the building.

Cooling is performed by individual units of the "split" type of different capacities and ages (conditions) with the installation of outdoor units directly on the facade. Ventilation is natural through window openings. Sun protection is realized by internal curtains of the Venetian type, i.e. canvas curtains.

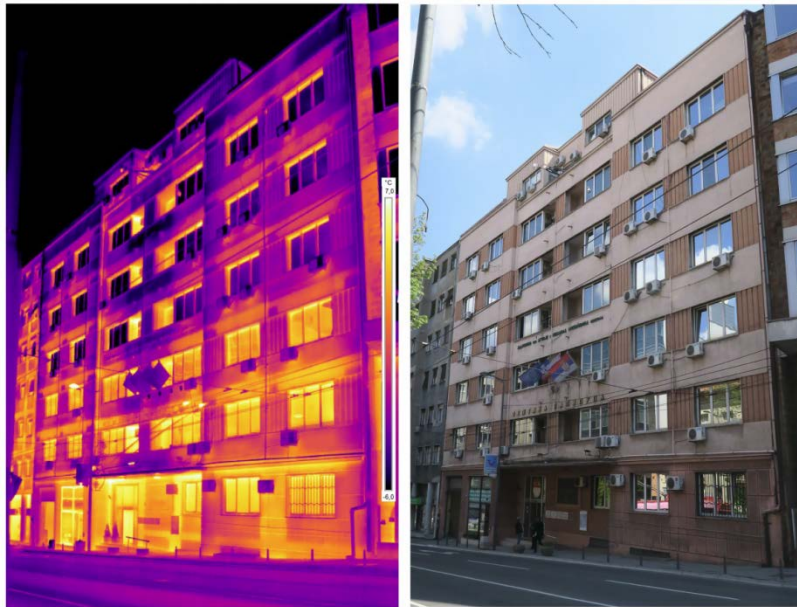

Figure 1. *Thermal imaging and photograph of the street facade of the building of the City Municipality of Palilula. The image clearly shows heat losses in horizontal reinforced concrete cerclages as well as beams over windows. No vertical reinforced concrete elements are observed*

3.1.2. Improvement measures

Improvement measures are grouped in three improvement packages presented on 0. The first level of improvement is achieved by:

- Replacing existing PVC windows with new ones, with six-chamber PVC profiles with triple glazing filled with argon and low-emission coating. The geometrical characteristics of the newly planned windows (size and composition/division) are the same as existing ones, but the newly planned windows are characterized by a better heat transfer coefficient of $U = 1.5 \text{ W/m}^2\text{K}$.

The second level of improvement involves the following architectural interventions:

- Thermal insulation of the courtyard facade was performed by placing a thermal insulation layer of 12 cm of stone wool over the existing facade.
- Thermal insulation of the courtyard facade overhangs was performed by placing a layer of stone wool 15 cm thick and a final layer of cement mortar.
- Thermal insulation of mezzanine structures towards the attic space was performed by installing a layer of 15 cm stone wool with the addition of appropriate protective layers (steam dams, protective foils) in accordance with the requirements of building physics.
- The thermal insulation on the part of flat roof was planned. A 20 cm layer of stone wool on the underside and finished with plasterboard on the appropriate substructure.

For the third level of improving the performance of the building, the following additional interventions have been proposed:

- Thermal insulation of the street facade was performed by installing a thermal insulation layer of 12 cm of stone wool. The street façade is characterized by relatively reduced façade plastic,

and the intervention removed all layers up to the load-bearing layer of the wall and reworked the façade in accordance with the existing condition in terms of material and geometric characteristics. Work on this façade would require a long-term disruption of pedestrian traffic since the walkway in front of the building is very small so therefore this intervention is not included in the second scenario.

- Thermal insulation of pitched roof above the attic office space was performed by adding a thermal insulation layer of 22 cm of stone wool between the existing rafters. This roof already had 12cm of thermal insulation and works on the inside of the roof would require eviction of offices and demolition of existing finishes so it was therefore not part of second improvement strategy.

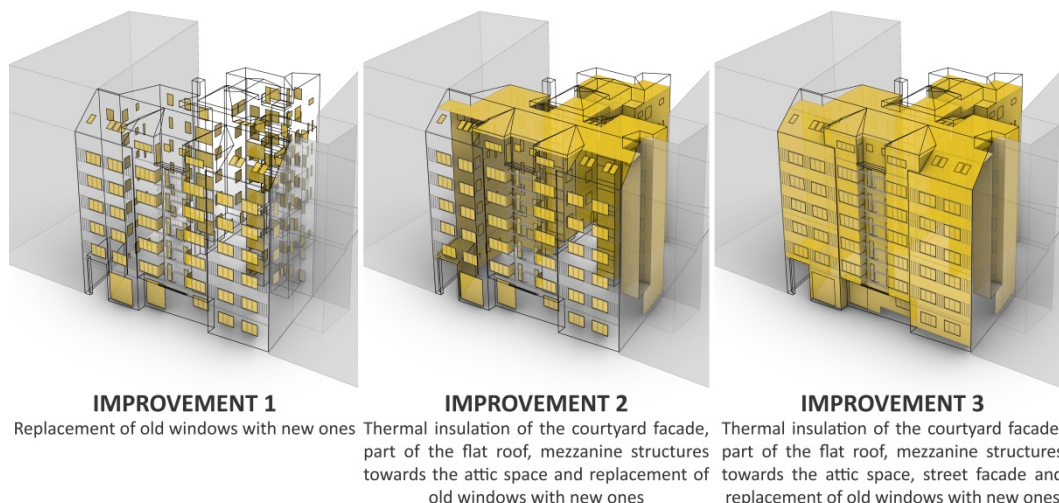

Figure 2. Illustration presenting elements of the Palilula municipality building's thermal envelope intervened upon in first, second and third level of improvement (from left to right)

3.2. ZEMUN MUNICIPALITY BUILDING

3.2.1. Existing condition of the building

The subject of the energy efficiency study is the building of the City Municipality of Zemun in Magistratski trg No. 1. The building of the seat of the City Municipality of Zemun, in its original form, was built in 1886. and has undergone significant changes and additions to this day. The thermal envelope of the building is very heterogeneous as a result of a number of interventions carried out since the construction of the building, which changed the volume, appearance and constructive material characteristics. Today, this building is part of a protected historical urban area and all interventions on the building's facade need to comply with the conditions issued by the Institute for the Protection of Cultural Monuments of the City of Belgrade.

The building is built in a massive structural system with load-bearing solid brick walls of various formats and thicknesses. The basement walls in the old part are built of bricks of the old format 14/29/7, with a total thickness of 80 cm. On the added part, the walls are built with a new brick format 12/25/6.5 with the total thickness of 60 cm. The walls of the ground floor in the old part are also built of old bricks and treated with a layer of decorative plastic in the form of artificial stone on the outside with a total thickness of 60 cm, while the new part has a total width of 50 cm. The walls of the first floor have a total width of 50 cm, and 40 cm in the new part. Second floor walls (completely rebuilt after the Second World War) were built using a new brick format, 40 cm wide on both parts. The attic walls are 25 cm wide brick walls with a 8 cm thick gypsum layer added on the inside, leaving the layer of air 20-25 cm wide in between the gypsum and masonry wall.

The available project documentation cannot determine the existence of reinforced concrete elements, as well as thermal imaging conducted during the energy audit, except in the extended part of the building. (see Figure 3)

The roof construction of the attic is wooden with a profiled tile cover. By adapting the attic, a new wooden structure was added in the form of rafters on the underside of the existing structure and a layer of plasterboards was placed towards the attic space. In the zone between the rafters, a layer of 10 cm thick insulation was placed.

Windows were changed in the 90's with the installation of PVC profile windows. Historically, several interventions have been performed at the position of the window, which have changed the type and structure of the window. The existing roof windows were installed during the last reconstruction and do not have the appropriate thermal characteristics by today's standards. (see Figure 3) The facility is supplied with thermal energy through a district heating system from the Public Utility Company of the Belgrade Power Plant using a radiator heating system.

Cooling is performed by individual units of the split type. Ventilation is natural, through window openings. Sun protection is via internal curtains of the Venetian type and external blinds on the roof windows on the south and southwest side of the building.



Figure 3. *Thermal imaging and photograph of the street facade of the building of the City Municipality of Zemun. Heat losses are evident in the area where concrete beams are - over windows and in the area of window openings*

3.2.2. Improvement measures

Improvement measures are grouped in three improvement packages presented on Figure 4. The first level of improvement is achieved by:

- Replacing existing PVC windows with new wooden ones, according to the conditions obtained from the Institute for the Protection of Cultural Monuments of the City of Belgrade. The newly planned solid wood windows are glazed with thermopane glass with geometric characteristics (sash division and decorative moldings) matching the original windows, according to the available information on the original windows. Newly planned windows are characterized by a heat transfer coefficient of $1.5\text{W}/\text{m}^2\text{K}$, in accordance with the Rulebook [5]. The dismantling of the existing as well as the installation of new windows is planned on the inside of the building, so as to reduce the risk of damage to the facade, that would require additional work.
- Replacing existing roof windows with the same type windows with better thermal performance. Disassembly and reassembly are planned from the inside with all the necessary cladding according to the type of cover. Glazing is with laminated inner and tempered outer glass $U_w = 1.5\text{W}/\text{m}^2\text{K}$.

The second level of improvement involves applying additional architectural interventions in the form of:

- Thermal insulation of the courtyard facade by placing a 10 cm thick stone wool layer over the existing facade.
- Thermal insulation of the courtyard facade overhangs by placing a layer of stone wool 20 cm thick and a final layer of cement mortar on the rabbit net.
- Thermal insulation of slabs towards the attic space was done by installing a layer of 20 cm stone wool with appropriate protective layers (steam dams, protective foils) in accordance with the requirements of building physics.
- Thermal insulation of pitched roof above the attic office space was performed by adding a thermal insulation layer of 24 cm of stone wool between the existing rafters.

The third level of improving the performance of the building was done by adding proposed intervention:

- Insulating the street facade was by installing a thermal insulation layer of 10 cm of stone wool on the inside of the facade wall, due to the limitations issued by the Institute for the Protection of Cultural Monuments of the City of Belgrade.

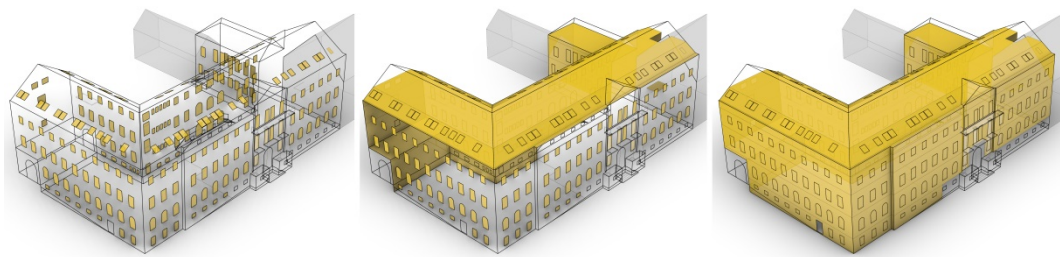

IMPROVEMENT 1

Replacement of old windows with new ones

IMPROVEMENT 2

Thermal insulation of the courtyard facade, ceilings towards the unheated sloped roof spaces and replacement of old windows with new ones

IMPROVEMENT 3

Thermal insulation of the courtyard facade, ceilings towards the unheated attic spaces, pitched roof, street facade and replacement of old windows with new ones

Figure 4. Illustration presenting elements of the Zemun municipality building's thermal envelope intervened upon in first, second and third level of improvement (from left to right)

4. RESULTS AND DISCUSSION

Calculations show that reviewed buildings can be substantially improved from the aspect of energy efficiency and even get to energy class "C", prescribed by the regulations as a mandatory level of energy performance of newly built facilities. (See Figure 5)

Removing the old windows and adding new, geometrically and stylistically identical but with better thermal characteristics has a surprisingly different effect on the building's energy consumption. This change has had little effect on Palilula's building performance and a much greater change in Zemun municipality building's energy consumption in the first improvement package. (see Figure 6) This can be explained by worse performing existing windows in Zemun, with greater ventilation losses and with the predominant window orientation. In Zemun, most of the windows face east or west, while Palilula municipality has most of the windows with south orientation. With higher solar gains to start with, better performing windows have not had such a great impact considering only energy needed for heating is calculated.

Since the new windows in Zemun municipality's building were installed in the openings where the original windows, equipped with Esslinger blinds used to be, there is a difference in height, which was solved by installing a "blind" overhead light.

Thicker outer walls, greater volume and a more compact form of Zemun municipality building make it more energy efficient than Palilula municipality building to start with (see Figure 5). Since thicker walls have a better U value, the impact of adding thermal insulation on them has less of an effect on the entire building's energy performance, as can be seen on Figure 5 for second improvement strategy.

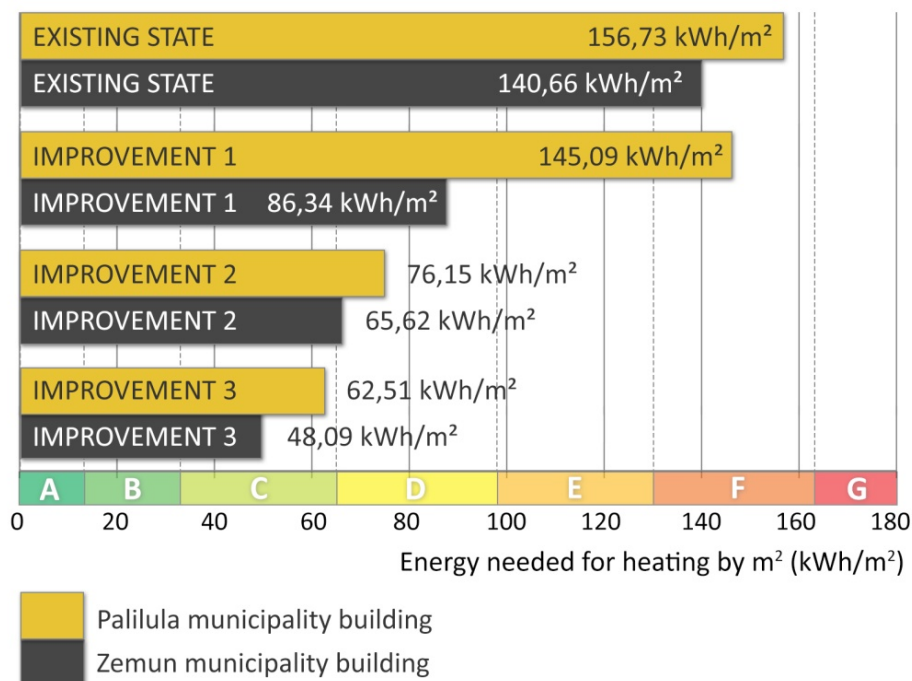

Figure 5. Comparison of energy needed for heating Palilula and Zemun municipality buildings during winter months per square meter in existing state, first, second and third level of improvement (from top to bottom); CO_2 emission and primary energy are linear to this function

Adding thermal insulation to the street facade, in the third improvement strategy, although difficult, is necessary for existent building to reach a "C" energy rating. In Palilula's municipality building it was sought to preserve the visual style of the building, so after adding a 12 cm thermal insulation to the facade, all existing facade features and stylistic elements are planned to be made again using cement mortar. In Zemun municipality building however, building's facade cannot be intervened upon by the conditions given by the Institute for the Protection of Cultural Monuments of the City of Belgrade. Therefore, thermal insulation has to be added from the inside of the building. Such intervention is not usually looked upon favourably by investors because it requires construction work done from the inside of the building, meaning the offices need to be moved elsewhere until the work is complete. Also, such action reduces the inside volume of the building which can be view by the occupants as a bad thing, but since these old buildings usually have large rooms with high ceilings it can be also considered as a good thing because the reduction of the heated volume further decreases building's energy needs. Also, these buildings were not built for electrical and communication systems they are now required to have. Adding insulation on the inside of the facade walls allows for major installation overhaul - it presents the space and the opportunity to install all the needed electrical, heating/cooling, internet and communication infrastructure a modern administrative building needs.

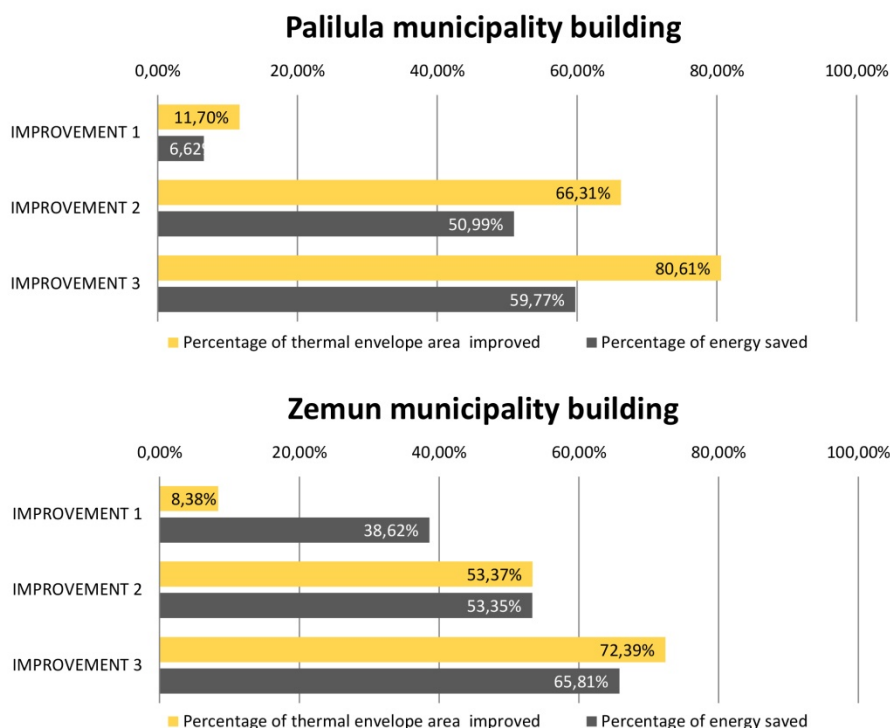

Figure 6. Diagram comparing the percentage of Palilula and Zemun municipality building's thermal envelope area intervened upon in first, second and third level of improvement with the percentage of energy saved for heating (percentage of CO₂ emission reduction and primary energy reduction are the same)

Every building has its "weak spot" from the point of energy efficiency, as can be clearly seen in Figure 6, and improving that part of the thermal envelope brings the best building performance for the minimal intervention. But, as can also be seen in Figure 6, the wider the scope of the intervention - the more measures are taken, the less efficient those measures become. So, at one point, improving existing building's thermal performance by taking simple architectural measures becomes redundant. Therefore, we think the best refurbishment strategy for existing public buildings is a fourth improvement scenario which would be redesign - a total overhaul of the building making it better suited for use in present time. Such an approach would take into account functional, structural and aesthetic aspects of the building, as well as the energy aspect, thus creating a building from a different time well suited for this one.

5. CONCLUSION

Existing public buildings, especially municipality buildings, are an important part of a city's building fund. They are representatives of the values of a society that built them and historical monuments testifying to the design principles, construction techniques, materials and available technology of the time of their construction. Many of these buildings were not originally designed for the function they now serve and are ill equipped to meet the conditions the contemporary way of life requires of them. Therefore, these buildings need to be upgraded to meet our demands in terms of comfort and performance.

Using two public municipality buildings in Belgrade, Serbia as a case study, this paper proves that existing public buildings can be refurbished by using simple architectural measures to the level of user comfort and energy efficiency required from the newly built facilities, regardless of the level of protection they are under. These simple measures consist of adding a layer of thermal insulation to the elements of the building's thermal envelope - walls, ceilings, flat or pitched roofs etc. both from the outside and inside of the building or changing the window opening with new ones having better thermal characteristics.

However, since many existing public buildings require more than just simple measures to meet the demands of contemporary society, attention needs to shift from the concept of refurbishment to the concept of redesign - a total functional, structural and aesthetic overhaul of the building razing it to the level of functional needs and aesthetics of the 21st century.

ACKNOWLEDGMENTS

The paper is a part of the research funded by the Ministry of Education, Science and Technological Development of the Republic of Serbia, under the grant number 451-03-68/2020-14/200090. Energy refurbishment projects included in this research are done in collaboration with ASOR - Association for Sustainable Development. The research is done under research labs of University of Belgrade - Faculty of Architecture: Building stock laboratory and SaRA (Sustainable and Resilient Architecture).

LITERATURE

- [1] Ignjatović, Dušan, Ćuković Ignjatović, Nataša and Jovanović Popović, Milica, "Potential for energy efficiency and CO2 emission reduction by refurbishment of housing building stock built before 1919. in Serbia," *Fresenius environmental bulletin*, vol. 26, pp. 1201-1209, 2017.
- [2] Jovanović Popović, Milica, Đukanović, Ljiljana and Nedić, Miloš, "Energy refurbishment of public buildings under cultural heritage protection in Serbia: Constraints and potentials," *Thermal Science*, vol. 22, pp. 1285-1296, 2018.
- [3] Jovanović Popović, Milica, et al., et al. *School and Kindergarten Buildings - A methodological framework for the formation of typology and the improvement of energy efficiency*. Belgrade: GIZ - Deutsche Gesellschaft für internationale Zusammenarbeit, 2018. 978-86-80390-28-4.
- [4] Ministry of Construction. Transport and Infrastructure of Republic of Serbia. Rulebook on Conditions, Content and Method of Issuing Energy Performance Certificates. The Official Gazette of Republic of Serbia No. 69/2012, 2012.
- [5] Ministry of Construction. Transport and Infrastructure of Republic of Serbia. The Rulebook on the Energy Efficiency in Buildings. The Official Gazette of Republic of Serbia, No. 61/2011, 2011.
- [6] Jovanović Popović, Milica, et al., et al. *National typology of residential buildings in Serbia*. Beograd: University of Belgrade - Faculty of Architecture and GIZ - Deutsche Gesellschaft für internationale Zusammenarbeit, 2013. 978-86-7924-102-3.



Darija Gajić, University of Banja Luka, darija.gajic@aggf.unibl.org
Saša Zečević, ARS STUDIO d.o.o. and Center for Spatial Research, Banja Luka,
zekozmaj782@gmail.com
Milovan Kotur, University of Banja Luka, milovan.kotur@mf.unibl.org
Aleksandar Janković, Norwegian University of Science and Technology, NTNU, Trondheim,
aleksandar.jankovic@ntnu.no

ENERGY AND ECONOMIC ANALYSIS OF THE RENOVATION OF THE KINDERGARTEN IN BANJA LUKA ACCORDING TO THE CURRENT RULEBOOK AND NZEB

Abstract

In the subject area, the term nZEB standard appears in 2011 in the legislative framework, but it never came to life, nor in the construction of new buildings, and completely unknown in the renovation of buildings. The reasons for this are insufficiently researched possibilities, i.e., unanalysed energy savings and economic profitability during the building renovation according to the valid regulations and the nZEB standard. This research analysed a specific type of building, a kindergarten, which must also respect the rules and does not have its own classification related to energy classes. Analysis has shown that, depending on the type of building, all possibilities for improving construction should be explored, not only in energy but also in redesign shape, since in this way, it is possible to reduce energy consumption to a minimum.

Keywords: nZEB, kindergarten, renovation, energy consumption, economic analysis

ЕНЕРЕГЕТСКА И ЕКОНОМСКА АНАЛИЗА ОБНОВЕ ВРТИЋА У БАЊОЈ ЛУЦИ ПРЕМА ВАЖЕЋЕМ ПРАВИЛНИКУ И nZEB-у

Сажетак

На предметном подручју термин nZEB стандарда, појављује се још 2011. године у законодавном оквиру, али никад није заживио, нити у изградњи нових зграда, а као концепт потпуно је непознат при обнови зграда. Разлози томе су недовољно истражене могућности, односно неанализирана енергетска уштеда и економска анализа при обнови зграда према важећем правилнику и према nZEB стандарду. Ово истраживање се води специфичним типом зграде, вртићем, који такође у важећем правилнику нема своју класификацију везану за енергетске разреде. Анализе су показале да у зависности од типа зграде, треба истражити све могућности унапређења зграде, не само у енергетском, него и у просторном и обликовном смислу, јер на такав начин могуће је потрошњу енергије свести на минималан ниво.

Кључне ријечи: nZEB, вртић, обнова, потрошња енергије, економска анализа

1. INTRODUCTION

The Energy Efficiency of Buildings Directive (EPBD) from 2010 [1] and Regulation EU No 244 from 2012 [2] require the Member States to establish minimum energy efficiency requirements for new buildings and existing buildings that need to be renovated. In line with these minimum requirements, the 2010 EPBD clearly states that all new buildings must be eligible for near-zero energy (nZEB) or have very low energy needs. Full implementation and enforcement of existing energy legislation are recognized as priorities in establishing an energy union [3]. Two critical requirements under this existing legal framework were to ensure that all new buildings are near-zero energy buildings by 31 December 2020 (two years earlier for public buildings) and to support the adaptation of existing buildings to near-zero energy buildings by setting zero-energy buildings as building standard from 2020. As Bosnia and Herzegovina (B&H) is signing the Energy Community Treaty, assuming the obligations of harmonizing the legal framework with the EU acquis in the energy sector [4], since 2016 on the entire territory of B&H (the first Rulebook was created in the Federation of Bosnia and Herzegovina in 2010) [5], which has been completely changed and is valid since 2019 on the territory of the Federation of B&H [6], and in the Republika Srpska, the Rulebook from 2016 is valid [7] legislation following European Union directives has come to life, but the above requirements have not yet come to life. The European Union has been focused on the objectives of the nZEB since 2010, while the legislation in B&H does not require the construction of nZEB, nor does it provide incentives for their construction, although this has been mentioned in legislative documents since 2011 [8]. As in the legislation of B&H, the energy efficiency indicator is guided by the numerical parameter of energy need for heating, and there are no primary energy indicators for the new construction of buildings. Numerical parameters for energy characteristics are based on cost-optimal analysis of B&H, led to the analysis of the nZEB of neighboring countries in the European Union, such as the regulations of the Republic of Croatia [9],[10],[11], and Slovenia [12],[13],[14].

It is interesting that in Austria, buildings are prescribed for nZEB four main energy indicators: energy need for space heating "*Heizwärmebedarf*" in [kWh/m²a], primary energy demand in [kWh/m²a], carbon dioxide emission in [kg/m²a], and total energy efficiency factor fGEE [15].

Primary energy consumption might not be an adequate indicator for a cross-country comparison. Since additional steps from the energy need going through the energy use and the delivered energy involve additional parameters that change from country to country, the comparison becomes less transparent and therefore less meaningful. The intention of setting a national nZEB definition is not, first of all, a smooth cross-country comparison but rather the push of energy performance in the building stock. Nevertheless, we believe that a system that allows for cross-country comparison would lead to higher transparency and higher energy performance standards [16].

nZEB standard has not yet come to life in EU countries in the renovation of buildings, and recommendations EU8 (Focus of vulnerable groups) ZEBRA2020 project are that such a way of renovation could affect energy poverty [17].

In addition to the above requirements, the EU has established a new Directive since 2012, defining the need to develop and adopt a long-term strategy to encourage investment in the reconstruction. That refers to the housing and commercial buildings, public and private [18], because the existing fund of buildings are being renovated very slowly. The Directive requires that every three years, building renovation strategies be published, and in the latest European strategy from 2020 [19], it is emphasized that the renovation of buildings should be up to nZEB standards and, of course, following the promotion of green infrastructure and the use of organic building materials that can store carbon, such as sustainably-sourced wood.

This research aims to point out the usefulness of applying nZEB standards through energy and economic analyzes of kindergarten renovation by using the current Ordinance on minimum requirements for energy performance of buildings (designed solution) and applying nZEB standards in the Banja Luka area (improved solution). The "KI Expert Plus" program was employed to calculate individual energies. This research directly aims to provide an example of good practice in building renovation, such as kindergartens.

Kindergarten buildings are most often ground-floor free-standing buildings of relatively high value, building shape factors ($f_o = 0.7-1.1$ [m⁻¹]), which means that they belong to the categories of buildings with high energy need for heating [20].

Kindergartens are not implemented in any legislation in EU countries for a specific purpose, nor are they performed in the Recommendations of the European Commission for numerical benchmarks for nZEB primary energy use indicators where the purposes are classified into residential and commercial use [21].

2. NZEB AND TRENDS IN BUILDING RENOVATION IN THE EU

The nZEB concept was introduced in the early 2000s and has been well received and developed over the years. Thanks to global initiatives, it has spread rapidly worldwide, both in terms of concept and practical application. The nZEB offers a holistic approach in which the building is seen from energy, environment, and economic perspectives, bringing in close the built and natural environment and end-users [22]. Sweden (2006), Estonia (2007), Norway (2007), and Germany (2009) were among the first countries to incorporate this concept into national legislation in a certain way [23]. Zero energy buildings in the European Union are defined through the EPBD Directive, but due to differences in national laws, the possibility is left for each member to introduce additional parameters. That primarily refers to the calculation of primary energy consumption, but the system is so complex that it is challenging to set uniform limits due to the calculation itself. Nearly zero-energy buildings are buildings with very high energy efficiency, i.e., the consumption of electricity or heat from utility systems is reduced to zero or a very low amount of energy that should be significantly covered by energy from renewable sources. In addition, it is necessary for the nZEB building to produce this energy from renewable sources within or near the building.

It is not possible to establish a uniform definition for all EU countries at the moment, but the EPBD directive provides a framework, leaving member states the opportunity to adjust the definition according to their national laws.

Through the EPBD directives, the European Union has guided the entire building sector by setting zero energy buildings as the standard for construction from 2020. From the 2015 report [24], it can be seen that most countries have introduced in their national legislation that nZEB represents about 25-50% lower primary energy than that required by applicable regulations. In some countries, there are restrictions on primary energy indicators for nZEB, differing a lot from country to country. E.g., Denmark – 20 kWh/m²a for residential and 20 kWh/m²a for another purpose; France – 50 kWh/m²a for residential and 20 kWh/m²a for other buildings; Malta - 40 kWh/m²a for residential and 60 kWh/m²a for other purposes; Slovenia - 75 kWh/m²a for a single-family house, 80 kWh/m²a for the multi-family house and 55 kWh/m²a for other purposes. It is even more interesting that in Slovenia, the established limit for the energy need for heating $Q_{h,nd}$ on 25 kWh/m²a [24].

After that, as early as next year, the European Commission will issue Recommendations for the benchmark of primary energy indicator values, which member states should adhere to when formulating their definition. The amount of indicators is determined in relation to the technology price scenario for 2020. The proposed values are divided into residential and commercial buildings according to four climate zones (Mediterranean, Oceanic, Continental, Nordic). E.g., for Continental: — Offices: 40-55 kWh/m²a of net primary energy with, typically, 85-100 kWh/m²a of primary energy use covered by 45 kWh/m²a of on-site renewable sources; — New single-family house: 20-40 kWh/m²a of net primary energy with, typically, 50-70 kWh/m²a of primary energy use covered by 30 kWh/m²a of on-site renewable sources [21]. It is important to emphasize that these Recommendations of the European Union emphasize that benchmarks are usually provided in terms of energy needs. Underlying reasons are the fact that energy needs are the starting point for the calculation of primary energy, and therefore a very low level of energy need for heating and cooling is a vital precondition for nearly zero primary energy buildings. Very low energy needs are also a precondition to achieve a significant share of renewable energy sources and almost zero primary energy.

The further development of nZEB definitions and the setting of energy performance requirements in buildings can be improved through the lessons learned from the already in place nZEB buildings. Although it is shown that the climate condition is one of the main parameters that make a direct comparison of nZEB definitions among EU countries very difficult, an interesting outcome from a recent analysis shows differently [25]. The EU IEE ZEBRA2020 project [26] analyzed characteristics of 411 representative European high energy performance buildings (new and renovated, residential, and non-residential), mainly in mild-cold climates. It has been deduced that the climate conditions do not represent the main parameter affecting the definition of the technology package to achieve the nZEB target.

The share of energy for buildings in energy consumption is 40%. Today's annual building renovation rate is 0.4 to 1.2% in the Member States. This rate will need to be doubled to meet the EU's energy efficiency and climate goals. At the same time, 50 million consumers have difficulty adequately heating their homes. To address the dual issue of energy efficiency and affordability, the EU and Member States should engage in a "wave of renovation" of public and private buildings. Although increasing renewal rates is a challenge, renewal reduces energy bills and can reduce energy poverty [27].

Trends in the renovation of buildings can be followed through realized scientific research projects of the EU from 2009 until today. The first was guided by the concept of renovation of prefabricated panel cladding with renewable and organic materials such as [28],[29]. Later, this was followed by [30],[31],[32].

Research and design analyses of kindergartens were guided by the methodology presented in the research paper [33], where the authors expected that the presented methodology would stimulate evaluation of recent practice towards compatibility with future law legislative and strategic plans of EU research and innovation programs, Figure 1. NZEB standards in kindergartens are analyzed in many research papers, e.g. [34], [35], [36].

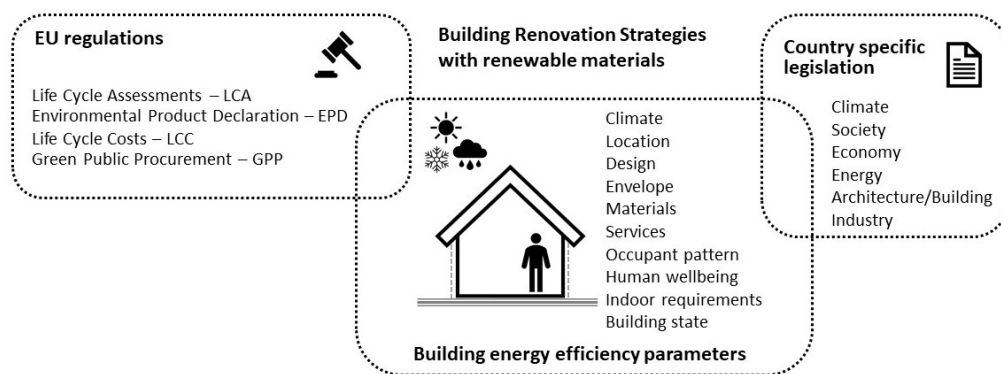

Figure 1. *Building renovation strategies with renewable materials.* [33]

3. POSSIBILITIES OF STANDARD AND IMPROVED RENOVATION OF KINDERGARTEN IN BANJA LUKA

The research analyzes a building in Banja Luka, constructed in 1962 when the Rulebook on thermal protection was not in force. One period, the building was devastated and abandoned, and in June 2020, at the initiative of investors from the City of Banja Luka and UNDP B&H, the reconstruction and rehabilitation of the kindergarten building were started, followed by the concrete realization.

The standard solution for the renovation of the building was guided by the main project of reconstruction and rehabilitation of the building, based on the current Ordinance on minimum requirements for energy performance [37] and the Rulebook on pedagogical standards and norms for the field of preschool education [38],[39]. The goal is to review the standard solution, identify possible shortcomings and opportunities for improvement, and offer a new design solution for improvement, i.e., to meet the energy characteristics of nZEB. The part of the building that has already been built is the starting point for both variants. The standard solution is a variant that would otherwise occur in the real sector. The second improved variant is led by nZEB under the condition that lower values of U-values are applied to the cladding elements than in the standard solution. The building shape factor is improved, and more than 30% of the annual energy delivered for the operation of technical systems in the building is reconciled with energy from renewable energy sources. The concept of renovation using renewable materials was also applied to the improved solution. In both solutions, the thermo-technical heating and cooling systems are heat pumps with central hot water preparation and a ventilation system with 75% efficiency recovery.

3.1. STANDARD RENOVATION OF KINDERGARTEN

The current Rulebook on minimum requirements for energy performance of buildings in the Republic of Srpska was created by cost-optimal analyses in numerical indicators related to the building envelope, i.e., heat transfer coefficients - U-values. As an indicator of energy efficiency of the building, energy need for heating, already during the renovation of the complete envelope it is possible to achieve the stated reduction of energy need for heating, which is different depending on the construction period (existence of thermal insulation on the envelope and its thermal characteristics and thickness) and building shape factor (the ratio of the envelope surface and the volume of heated space).

The kindergarten has an "L" shape. The vertical dimension of the building is defined by the ground floor (Figure 2). According to the existing condition, the elevation of the building with respect to the terrain is raised by 50 cm or, according to the designed solution, by 60 cm. Stairs and a ramp overcome this height difference. There are two entrances for users on the north and east sides and two economic entrances on the north side.



Figure 2. Standard renovation of kindergarten was realized in May 2021. Source: authors

The building is made in a classic masonry system with brick walls 25 cm thick and brick reinforcements in the form of extensions 38 cm thick, about 100 cm long. At the corners and half of the span of the sides, there are vertical circles 25x25 cm connected by horizontal beams 30 cm wide and 25 cm high, i.e., 40 cm, along the facade walls. The ceiling is made of wooden beams - ceiling tiles 18/20 cm; there is a board edging and the reed plaster on the lower side. A wooden plank was also made towards the attic on the upper side. Designed solution - standard renovation envisages construction of a contact facade with expanded polystyrene insulation ($\lambda=0.042$ [W/mK]) 15 cm thick and a final layer of silicate-silicone precious plaster, then windows with plastic frames and three-layer thermal insulation glass with low-E coating and filled with Argon (average $U_w=1.10$ [W/m²K]). The floor is covered with waterproofing with 10 cm of extruded polystyrene ($\lambda=0.035$ [W/mK]) over which the protection from PVC foil is placed, and then the cement screed with the final layer of epoxy. As the roof structure is above the unheated attic, the installation of mineral wool was planned and carried out ($\lambda=0.038$ [W/mK]) in a thickness of 20 cm on the mezzanine structure under the unheated attic, Table 1.

Table 1. U-values of characteristic elements of the facade cladding - designed solution

Construction element	A [m ²]	U [W/m ² K]	U _{max} [W/m ² K]
Facade wall	477.54	0.23	0.30
Windows	79.31	1.10	1.60
Floor	392.06	0.32	0.30
Roof	392.06	0.17	0.20

The designed solution retains the basic concept of the building, which means that the geometric characteristics have not changed. During the works, it was noticed that the thermal bridges and the tightness were not adequately resolved, so the expected airflow was reduced to the volume of heated air, with a pressure difference between indoor and outdoor air of 50 Pa estimated at $n_{50} = 2.00$ h⁻¹. Table 2.

Table 2. Geometric characteristics of the designed solution – standard renovation

The envelope surface of the heated part of the building	A [m ²]	1426.33
The volume of the heated part of the building	Ve [m ³]	1800.10
Heated air volume	V [m ³]	1368.07
Shape factor - A/V ratio	-	0.79
The useful floor area of the heated part of the building	A [m ²]	397.08
Windows factor	%	20.23
Number of air changes at a pressure difference of 50 Pa	n_{50} [h ⁻¹]	2.00

The capacity of groups for children under three years of age is 36 children, two groups of 18 children each, and the group of 3 to 6 years old is 25 children. So the total capacity according to the projected solution was 86 children. The building met the prescribed U-values and the transmission loss coefficient per unit of the heated part of the building, according to the designed solution for which the building permit was obtained. Annual energy need for heating per unit of usable area of the heated part of the building $Q''_{H,nd}$ amounts 91.88 kWh/(m²a), which according to the Rulebook [40] brings the building to D class. Although the building has lower U-values than the prescribed, the permitted coefficient of transmission loss does not reach the permitted energy class C for buildings for education and culture and other offered categories of buildings.

3.2. IMPROVED RENOVATION OF KINDERGARTEN

The improved solution, which aims to reach the nZEB standard, was primarily driven by changing the shape factor because the standard design solution showed that it was impossible to achieve the required energy need for heating, i.e., energy class C. The shape factor was improved by upgrading the gallery. Following the trends in the EU and the potential of B&H in this construction material, it is planned to renovate the envelope and upgrade it with a wooden structure. Enhancement of the envelope was guided by a cross wooden substructure filled with thermal insulation, Figure 3, which was placed alternately in order to reduce the thermal bridges to a minimum.

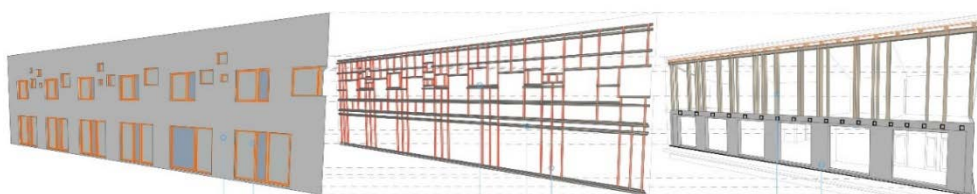

Figure 3. Improved renovation of kindergarten, 3D view - facade diagram according to TES principles. Source: authors

According to the improved solution, a single-pitched pitched roof was designed with a slope from south to north. The complete load-bearing structure is wooden. Transverse posts are attached to the massive wooden rafters from the upper side with thermal insulation installed between them and between the rafters as well, thus reducing the thermal bridges in the roof. According to the improved solution, it was planned to demolish the parapet and maximize the opening on the south and west sides, achieving a direct connection with the courtyard of the building, improving both the spatial and functional solution of the kindergarten. Gallery upgrading was planned so that the building on the south side has two floors and opens to the south to the maximum, and closes to the north, lowering the roof again to the level of one floor. In the extended part, i.e., the gallery, the play of dimensions and position of the opening was used as an architectural-visual element, creating a playful facade, contributing to the atmosphere of the interior space, Figure 4.



Figure 4. Improved renovation of kindergarten, 3D view. Source: authors

The improved renovation includes the construction of a wooden substructure with expanded polystyrene insulation ($\lambda = 0.034$ [W / mK]) 30 cm thick and a final layer of silicate-silicone precious plaster. In addition, the renovation envisages windows with wooden frames and three-layer thermal insulation glass with low-E coated and filled with Argon ($U_w = 0.90$ [W/m²K]). The floor is covered with waterproofing and 20 cm of extruded polystyrene ($\lambda = 0.035$ [W / mK]) over which the protection from PVC foil is placed, followed by cement screed and epoxy as the final layer. As the roof structure is above the heated gallery space, the installation of mineral wool ($\lambda = 0.034$ [W / mK]) in the thickness of 35 cm on the roof structure was planned and carried out. Table 3.

Table 3. U-values of characteristic elements of the facade cladding - an improved solution, Source: author's analysis

Construction element	A [m ²]	U [W/m ² K]	U _{max} [W/m ² K]
Façade wall on ground floor	427.66	0.12	0.30
Façade wall on the gallery	311.93	0.07	0.30
Windows	137.86	0.90	1.60
Floor	392.06	0.16	0.30
Roof	529.23	0.08	0.20

An improved solution has changed the geometric characteristics of the building. The research was conducted with properly resolved thermal bridges and sealing with the help of RAL window installation, so the expected airflow was reduced to the volume of heated air, with a pressure difference between indoor and outdoor air of 50 Pa was estimated $atn_{50} = 1.00 \text{ h}^{-1}$ Table 4. According to the improved solution, it was noticed that the usable area per child is small, and in the improved solution, it was kept with a minimum area of 2.75 m^2 per child, and for groups from 3 to 6 years, the usable area per child is 3.3 m^2 . The estimated total capacity is 120 children. In addition to increasing the accommodation capacity, additional rooms have been organized on the upgraded gallery, such as the administration office, meeting and presentation room, and storage.

Table 4. Geometric characteristics of the improved solution – improved renovation

The envelope surface of the heated part of the building	A [m^2]	1814.07
The volume of the heated part of the building	V_e [m^3]	2946.00
Heated air volume	V [m^3]	2238.96
Shape factor - A/V ratio	-	0.62
The useful floor area of the heated part of the building	A [m^2]	624.04
Windows factor	%	22.09
Number of air changes at a pressure difference of 50 Pa	n_{50} [h^{-1}]	1.00

According to the improved solution, the building met the prescribed U-values and the transmission loss coefficient per unit of the heated part of the building. Annual energy need for heating per unit of usable area of the heated part of the building $Q''_{H,nd}$ amounts $27.93 \text{ kWh}/(\text{m}^2\text{a})$, which according to [37] reaches the permitted energy class B for buildings for education and culture, as well as for all other offered categories of buildings.

With an improved solution, a canopy was designed to improve protection from the summer sun, which also served as a carrier for photovoltaic panels. The projected production of energy from renewable sources is 45.41%, and the consumption of primary energy per unit of usable area of the heated part of the building is $41.30 \text{ kWh}/\text{m}^2\text{a}$.

4. ENERGY AND ECONOMIC ANALYSIS OF THE RENOVATION OF THE KINDERGARTEN IN BANJA LUKA

In the comparative presentation, we see that by improving the geometric characteristics, i.e., appropriate upgrades, the usable area of the building can be increased by about 64%. At the same time, the amount of annual energy need for heating is reduced by about 70%. The energy need for cooling has been reduced by almost 50% by introducing external blinds on the windows and creating a canopy in the south as protection from the sun.

At nZEB Croatia, it is necessary to meet the conditions that for new buildings at least 30%, and for reconstructed / significantly renovated, 10% of the annual energy delivered for the operation of technical systems in the building is provided from renewable energy sources. As the design solution uses the same technical heating and cooling systems as the improved one, it reduced the total delivered energy to $38.11 \text{ kWh}/\text{m}^2\text{a}$, and primary energy on $61.51 \text{ kWh}/(\text{m}^2\text{a})$, which also indicates a very energy-efficient building, Table 5.

Table 5. Comparative presentation of geometric and energy characteristics of the designed and improved solution for the renovation of the kindergarten

	DESIGNED	IMPROVED
The envelope surface of the heated part of the building	$A = 1426.33 \text{ [m}^2\text{]}$	$A = 1814.07 \text{ [m}^2\text{]}$
Volume of the heated part of the building	$V_e = 1800.10 \text{ [m}^3\text{]}$	$V_e = 2946.00 \text{ [m}^3\text{]}$
Shape factor - A/V ratio	$f_o = 0.79 \text{ [m}^{-1}\text{]}$	$f_o = 0.62 \text{ [m}^{-1}\text{]}$
Useful area of the heated part of the building	$A_k = 397.08 \text{ [m}^2\text{]}$	$A_k = 624.04 \text{ [m}^2\text{]}$
Annual energy need for heating	$Q_{H,nd} = 39335.57 \text{ [kWh/a]}$	$Q_{H,nd} = 17431.69 \text{ [kWh/a]}$
Annual energy need for heating per unit of usable area	$Q''_{H,nd} = 91.88$ (max = 81.77) [kWh/m ² a]	$Q''_{H,nd} = 27.93$ (max = 72.90) [kWh/m ² a]
Annual energy need for cooling	$Q_{C,nd} = 9821.03 \text{ [kWh/a]}$	$Q_{C,nd} = 10263.49 \text{ [kWh/a]}$
Annual energy need for cooling per unit of usable area	$Q_{C,nd} = 25.47 \text{ [kWh/m}^2\text{a]}$	$Q_{C,nd} = 16.45 \text{ [kWh/m}^2\text{a]}$
Total energy delivered	$E_{del} = 14942.37 \text{ [kWh/a]}$	$E_{del} = 9204.57 \text{ [kWh/a]}$
Annual delivered energy per unit of usable area	$E''_{del} = 38.11 \text{ [kWh/m}^2\text{a]}$	$E''_{del} = 14.75 \text{ [kWh/m}^2\text{a]}$
Total primary energy	$E_{prim} = 24116.99 \text{ [kWh/a]}$	$E_{prim} = 25772.79 \text{ [kWh/a]}$
Total primary energy per unit of usable area	$E''_{prim} = 61.51$ (max = 90.00) [kWh/m ² a]	$E''_{prim} = 41.30$ (max = 55.00) [kWh/m ² a]
Coefficient of transmission heat loss per unit of heated part of the building	$H'_{tr,adj} = 0.44$ (max = 0.50) [W/m ² K]	$H'_{tr,adj} = 0.20$ (max = 0.54) [W/m ² K]

The use of photovoltaic cells in the improved solution created a difference in the delivered energy being greater than 60% and about 33% in the total primary energy compared to the designed solution. In addition, the nZEB of Croatia and Slovenia has the highest permitted annual primary energy per unit of usable area of the heated part of the building $E_{prim} = 55.00 \text{ [kWh/(m}^2\text{a)]}$, and an improved solution with $41.30 \text{ [kWh/m}^2\text{a]}$ satisfies the stated condition of the nZEB in the neighboring countries of the European Union.

Economic analysis based on current electricity prices (0.1229 BAM), being one of the lowest in Europe, indicates the cost-effectiveness of the improved, i.e., nZEB solution. The initial investment of the improved solution is 20% higher, while the delivered energy is 38% lower, Table 6.

Table 6. Comparative presentation of parameters that affect the economic analysis of the designed and improved solution for kindergarten renovation

	DESIGNED	IMPROVED	DIFFERENCE
$E_{del} \text{ [kWh/a]}$	14942.37	9204.57	5737.80
Total price (according to 0.1229 KM / kWh) in BAM	1836.41	1131.21	705.20
Total capacity	86	120	34
Total price of the stay (according to 165 KM / child / month)	170280.00	237600.00	67320.00
Initial investment	555139.39	697977.86	142838.57

The cost-effectiveness of the difference between the initial investment in designed and improved building renovation solutions is estimated at three years and eight months. In addition to energy savings, increasing the capacity of the number of users is also taken into account.

5. CONCLUSION

Regulations in Bosnia and Herzegovina have to undergo major changes, as energy efficiency indicators are not well set. The minimum energy performance requirements used for the representative kindergartens show that it is impossible to reach the energy need for heating of reference class C ($Q_{H,nd} \leq 65 \text{ kWh/m}^2\text{a}$) as defined for residential buildings or buildings for education and culture. This research proved that kindergartens must be introduced as a special category of

buildings with very low average U-values achieved ($U_{\text{wall}}=0.23 \text{ W/m}^2\text{K}$, $U_w=1.10 \text{ W/m}^2\text{K}$, $U_{\text{floor}}=0.32 \text{ W/m}^2\text{K}$, and $U_{\text{roof}}=0.17 \text{ W/m}^2\text{K}$), and a shape factor of 0.79, achieved the energy need for heating $Q''_{\text{H,nd}} = 91.88 \text{ kWh/m}^2\text{a}$ should be in energy class between B and C.

It was once again confirmed that the recommended EP indicator ($Q_{\text{H,nd}}$ - energy need for heating) for the permitted energy class C for kindergartens should be between $70.00 \text{ kWh/m}^2\text{a} \leq \text{EP} < 150.00 \text{ kWh/m}^2\text{a}$ [20].

NZEB standard for buildings in the kindergartens' category requires lower heat transfer coefficients than prescribed by the current Rulebook. In addition, research has shown that in addition to the U-values, the sealing of the building and the building shape factor are very important. To achieve the value of the energy need for heating at the nZEB standard below 25 kWh/m^2 (a requirement in Slovenia), U-values must correspond to the passive standard (below approx $0.1 \text{ W/m}^2\text{K}$), the envelope must be well sealed ($n_{50} = 1.00 \text{ h}^{-1}$) and the shape factor must be below $0.60 \text{ [m}^{-1}\text{]}$. To reach the value of the energy need for heating at the nZEB standard between $50\text{-}70 \text{ kWh/m}^2$, following other research in this field, it is enough that the U-values reach the current Rulebook, that the casing is well sealed (below $n_{50} = 1.50 \text{ h}^{-1}$) and that the shape factor is below $0.77 \text{ [m}^{-1}\text{]}$.

Since the requirement for primary energy is not defined in B&H, and knowing that most countries have introduced in their national legislation that nZEB represents about 25-50% less primary energy than needed, the renovation of the building followed Croatian regulations. According to Croatian regulations, in both cases (designed E "prim = $61.51 \text{ [kWh/m}^2\text{a]}$) and improved (E" prim = $41.30 \text{ [kWh/m}^2\text{a]}$), kindergarten solutions in the subject area had designed technical systems that generate very low primary energy values.

Although the improved solution is nZEB and such a standard requires primary energy per unit of usable area of the heated part of the building $E''_{\text{prim}} = 55.00 \text{ [kWh/m}^2\text{a]}$, the solution is less primary energy than required. Although an example of renovation/reconstruction of kindergartens using renewable materials, extending to the latest strategy of renovation of EU buildings, the improved solution exceeded the requirements of the Croatian nZEB for new buildings in delivered energy for technical systems in buildings with renewable energy.

LITERATURE

- [1] European Union, "Directive 2010/31/EU of the European Parliament and of the Council of 19 May 2010 on the energy performance of buildings (recast)," Official Journal of the European Union, 18 June 2010.
- [2] European Commission, "Commission Delegated Regulation (EU) No. 244/2012 of 16 January 2012 Supplementing Directive 2010/31/EU of the European Parliament and of the council on the energy performance of buildings by establishing a comparative methodology framework for calculating cost-optimal levels of minimum energy performance requirements for buildings and building elements," Official Journal of the European Union, 21 March, 2012.
- [3] European Commission, "Communication from the Commission to the European Parliament, the Council, the European Economic, and Social Committee," A framework strategy for a resilient energy union with a forward-looking climate change policy, COM 80 final, 2015.
- [4] Predsjedništvo Bosne i Hercegovine, "Ugovor o uspostavi energetske zajednice", Službeni glasnik BiH – Međunarodni ugovori, 09/06, 25 August 2006.
- [5] Federalno ministarstvo prostornog uređenja, "Pravilnik o tehničkim zahtjevima za toplotnu zaštitu objekata i racionalnu upotrebu energije", Službene novine FBiH, 49/ 09, 2009.
- [6] Federalno ministarstvo prostornog uređenja, "Pravilnik o minimalnim zahtjevima za energijskim karakteristikama zgrada", Službene novine Federacije BiH, 81/19, 2019.
- [7] Ministarstvo za prostorno uređenje, građevinarstvo i ekologiju Republike Srpske, "Pravilnik o minimalnim zahtjevima za energetske karakteristike zgrada," Službeni glasnik Republike Srpske, 15/30, April 2015.
- [8] Ministarstvo za prostorno uređenje, građevinarstvo i ekologiju Republike Srpske, "Član 3, Zakon o komunalnim djelatnostima Republike Srpske," Službeni glasnik Republike Srpske, 124/11, Novembar 2011.
- [9] Ministarstvo prostornoga uređenja, graditeljstva i državne imovine Republike Hrvatske, "Tehnički propis o racionalnoj uporabi energije i toplinskoj zaštiti u zgradama," Narodne novine, 128/15, 70/18, 73/18, 86/18, 2018.

- [10] Ministarstvo prostornoga uređenja, graditeljstva i državne imovine Republike Hrvatske, "Tehnički propis o izmjenama i dopunama tehničkog propisa o racionalnoj uporabi energije i toplinskoj zaštiti u zgradama," Narodne novine, 102/2020, 2020.
- [11] Ministarstvo graditeljstva i prostornog uređenja Republike Hrvatske, "Smjernice za zgrade gotovo nulte energije," Available: https://mpgi.gov.hr/UserDocsImages/dokumenti/EnergetskaUcinkovitost/Smjernice_2_dio_nZEB_mgipu.pdf, 2019.
- [12] Ministarstvo za okolje i prostor Republika Slovenija, "Tehnična smernica TSG-1-004:2010 učinkovita raba energije," Available: https://www.ozs.si/datoteke/ozs/sekcije/Janko%20Rozman/Sekcija%20instalaterjev-energetikov/TSG-01-004_2010_U%C4%8Dinkovita%20raba%20energije.pdf, 2010.
- [13] Ministarstvo za Infrastrukturo Republika Slovenija, "Akcijski načrt za skoraj ničenergijske stavbe za obdobje do leta 2020 (AN sNES)," Available: http://www.energetika-portal.si/fileadmin/dokumenti/publikacije/an_snes/ansnes_final_apr_2015.pdf, April 2015.
- [14] Ministrstvo za okolje in prostor Republike Slovenije, "Pravilnik o učinkoviti rabi energije v stavbah," Uradni list Republike Slovenije, 52/10, 61/17, 2017.
- [15] Österreichisches Institut für Bautechnik, "OIB-Richtlinie 6: Energieeinsparung und Wärmeschutz; OIB-330.6-009/15,," Available: https://www.oib.or.at/sites/default/files/richtlinie_6_26.03.15.pdf, March 2015.
- [16] J. F. Garcia and L. Kranzl, "Ambition Levels of Nearly Zero Energy Buildings (nZEB) Definitions: An Approach for Cross-Country Comparison," Buildings , vol. 8, no. 10, 2018.
- [17] A. Toleikyte et al., "Strategies for nZEB market transition on national level," ZEBRA 2020-Nearly Zero-Energy Building Strategy 2020, October 2016.
- [18] European Union, "Directive 2012/27/EU of the European Parliament and of the Council of 25 October 2012 on energy efficiency, amending Directives 2009/125/EC and 2010/30/EU and repealing Directives 2004/8/EC and 2006/32," Official Journal of the European Union, November 2012.
- [19] European Commission, "Communication from the Commission to the European Parliament, the Council, the European Economic and Social Committee and the Committee of the Regions," A Renovation Wave for Europe - greening our buildings, creating jobs, improving lives, COM(2020) 662 final, October 2020.
- [20] D. Gajić, D. Stupar, B. Antunović, and A. Janković, "Determination of the energy performance indicator of kindergartens through design, measured and recommended parameters," Energy Build., vol. 204, p. 109511, 2019.
- [21] European Commission, "Guidelines for calculating cost optimal levels for buildings - Commission Recommendation (EU) 2016/1318," Official Journal of the European Union, 2016.
- [22] N. Wang et al., "Ten questions concerning future buildings beyond zero energy and carbon neutrality," Build. Environ., vol. 119, pp. 169-182, 2017.
- [23] J. Kurnitski, "Nearly Zero-Energy Building's (nZEB) Definitions and Assessment Boundaries BT - Cost Optimal and Nearly Zero-Energy Buildings (nZEB): Definitions, Calculation Principles and Case Studies," J. Kurnitski, Ed. London: Springer London, 2013, pp. 7-30.
- [24] H. Erhorn and H. Erhorn-Kluttig, "Overview of national applications of the Nearly Zero-Energy Building (NZEB) definition," Concerted Action. Energy performance of buildings, 2015.
- [25] G. Paoletti, R. Pascual Pascuas, R. Perneti, and R. Lollini, "Nearly Zero Energy Buildings: An Overview of the Main Construction Features across Europe," Buildings , vol. 7, no. 2, 2017.
- [26] S. Schimschar, A. Hermelink, and A. John, "ZEBRA 2020-Nearly Zero-Energy Building Strategy 2020, Deliverable D2. 2: Tracking the market maturity for nZEB," Vienna Univ. Technol. Energy Econ. Group-EEG, Vienna, 2014.
- [27] Europska komisija, "Komunikacija komisije europskom parlamentu, europskom vijeću, vijeću, europskom gospodarskom i socijalnom odboru i odboru regija," Europski zeleni plan, COM(2019) 640 final, Decembar 2019.

- [28] P. Heikkinen, H. Kaufmann, S. Winter, and K. Larsen, "TES EnergyFaçade-prefabricated timber based building system for improving the energy efficiency of the building envelope," Final project report, 2011.
- [29] Y. Cronhjort et al., "Smart TES Innovation in timber construction for the modernization of the building envelope." Project report 26.06. 2011, 2012
- [30] W. Pan, K. Iturralde, T. Bock, R. G. Martinez, O. M. Juez, and P. Finocchiaro, "A Conceptual Design of an Integrated Façade System to Reduce Embodied Energy in Residential Buildings," *Sustainability*, vol. 12, no. 14. 2020.
- [31] G. Margani, G. Evola, C. Tardo, and E. M. Marino, "Energy, Seismic, and Architectural Renovation of RC Framed Buildings with Prefabricated Timber Panels," *Sustainability*, vol. 12, no. 12. 2020.
- [32] P. O. 't Veld, "MORE-CONNECT: Development and Advanced Prefabrication of Innovative, Multifunctional Building Envelope Elements for Modular Retrofitting and Smart Connections," *Energy Procedia*, vol. 78, pp. 1057-1062, 2015.
- [33] D. Gajić et al., "Energy Retrofitting Opportunities Using Renewable Materials–Comparative Analysis of the Current Frameworks in Bosnia-Herzegovina and Slovenia," *Sustainability*, vol. 13, no. 2. 2021.
- [34] M. Misceo, L Peralta, S. Angelillo, and P. Stefanizzi, "Analysis of energy performances of a nZEB kindergarten building in Bisceglie (Apulia region)", *IOP Conf. Series: Materials Science and Engineering* 609, 2019.
- [35] F. Bazzocchi, C. Ciacci and V. Di Naso, "Optimization of Solar Shading for a NZEB Kindergarten in Florence", *Eighth International Conference ISMO'19—Innovations-Sustainability-Modernity-Openness, Proceedings 2019*, vol.16 (1), no. 48, 2019.
- [37] F. Bazzocchi, C. Ciacci and V. Di Naso, " Study on solar shading systems for design nZEB kindergartens in Italy", *TEMA: Technologies Engineering Materials Architecture*, Vol. 6, No. 1, 2020, pp. 74-85
- [38] Ministarstvo za prostorno uređenje, građevinarstvo i ekologiju Republike Srpske, "Pravilnik o minimalnim zahtjevima za energetske karakteristike zgrada," *Službeni glasnik Republike Srpske*, br 30/15, 2015.
- [39] Ministarstvo prosvjete i kulture Republike Srpske, "Pravilnik o pedagoškim standardima i normativima za oblast predškolskog vaspitanja i obrazovanja," *Službeni glasnik Republike Srpske*, br 64/13, 2013.
- [40] Ministarstvo prosvjete i kulture Republike Srpske, "Zakon o izmjenama i dopunama zakona o predškolskom vaspitanju i obrazovanju," *Službeni glasnik Republike Srpske*, br 63/20, 2020
- [41] Ministarstvo za prostorno uređenje, građevinarstvo i ekologiju Republike Srpske, "Pravilnik o vršenju energetskeg pregleda zgrada i izdavanju energetskeg certifikata Republike Srpske," *Službeni glasnik Republike Srpske* br. 30/15, 2015.
- [42] , Milica, et al., et al. *National typology of residential buildings in Serbia*. Beograd: University of Belgrade - Faculty of Architecture and GIZ - Deutsche Gesellschaft fur internationale Zusammenarbeit, 2013. 978-86-7924-102-3.



Dajana Papaz, University of Banja Luka, dajana.papaz@aggf.unibl.org
Sandra Kosić-Jeremić, University of Banja Luka, sandra.kosic-jeremic@aggf.unibl.org
Maja Ilić, University of Banja Luka, maja.ilic@aggf.unibl.org

IMPACT OF DESCRIPTIVE GEOMETRY ON THE IMPROVEMENT OF SPATIAL ABILITIES OF ARCHITECTURE STUDENTS

Abstract

Spatial intelligence is an important skill for students of technical faculties, especially those fields where the capacity for engineering thinking and creative expression is equally valued. The field of Architecture is emphasized here, and the issue of assessing the spatial abilities of architecture students and their improvement has often been observed. This paper will examine the impact of the course of descriptive geometry on the development of their spatial thinking, and whether there is progress between the initial spatial abilities with which students were enrolled and abilities after completing the first semester of study.

Keywords: spatial abilities, spatial thinking, descriptive geometry, architecture.

УТИЦАЈ НАЦРТНЕ ГЕОМЕТРИЈЕ НА УНАПРЕЂЕЊЕ ПРОСТОРНИХ СПОСОБНОСТИ СТУДЕНАТА АРХИТЕКТУРЕ

Сажетак

Просторна интелигенција представља значајну вјештину за студенте техничких факултета, нарочито оних гдје се подједнако вреднују склоности према инжењерском мишљењу и креативном изражавању. Овдје се посебно истиче архитектонска професија, те је питање процјене просторних способности студената архитектуре и њихово унапрјеђење често испитивано. У раду ће се испитивати утицај курса нацртне геометрије на развој њиховог просторног мишљења, те да ли постоји напредак између иницијалних просторних способности са којима су студенти уписани и способности након одслушаног првог семестра студија.

Кључне ријечи: просторне способности, простоно мишљење, нацртна геометрија, архитектура.

1. INTRODUCTION

Studying architecture requires the ability of students to visualize, analyze, compose and manipulate different spatial elements inside their minds before presenting them by the analog or digital medium. It is highly necessary for them to be aware of the spatial relations in the environment to create new forms and to design different and unique structures. Every segment of a design process should be followed by multistep operations, where students/ architects need to have the capacity to switch between different projections and views [1]. Besides architecture, spatial abilities (SA) appeared to be the common requirement for all STEM fields (Science, Technology, Engineering, and Mathematics) [2].

To become competent and professional engineers, students of architecture are also necessitated to have a great aptitude for understanding and mentally visualizing spatial transformations, differentiating separate parts of the observed subject, and finally interpolating them into a complex system [3]. Therefore, during their studies, they are required to complete various courses that are expectantly going to improve their spatial abilities through different forms of tasks and exercises. Descriptive geometry (DG) is one of them, and it aims to provide essential knowledge and methods for understanding 3D space, presenting it as 2D drawings while being able to create new forms and shapes that are interrelating. An important part of the previous mention is that there is a difference between understanding 2D and 3D drawings, shapes, and objects.

Leopold, in her work, shows that Descriptive Geometry can provide the foundations for creating and understanding 2-D drawings of 3-D objects while it also impacts the development of spatial visualization abilities [4].

Architecture and its tight bond with spatial abilities were also studied by M. Berkowitz and his fellows [5]. The basic assumption of this paper was whether acquiring experience in architecture improves students' spatial abilities. These authors considered the existence of different types of spatial abilities while focusing on finding out whether some aspects of spatial thinking are more probable to be improved by acquired architectural experience. After a series of tests and discussions, it was concluded that architecture does influence spatial abilities, thus they do improve during architecture studies, already at the beginning of the studies [5].

At the Faculty of Košice, there was a study that included pretest and post-test methods by Baranová and Katreničová. Their findings proved that the DG course positively impacts the development of students' spatial skills. However, it seems to be one of the most difficult courses [6].

According to Sorby [7], the majority of spatial skills tests are supposed to evaluate a student's skill levels during the first two development stages. The first stage refers to, essentially, 2D tests that assess the topological spatial skills, but they appeared not to be significantly important for engineering educators. The second stage of development evaluates projective spatial skills, these tests consist of 3D graphics tasks, and they are mostly used by engineering graphics educators. The most used tests such as The Mental Cutting Test (MCT) [8], The Differential Aptitude Test: Space Relations (DAT: SR) [9] The Purdue Spatial Visualization Test: Rotations (PSVT: R) – developed by Bodner and Guay [10] are still a matter of discussion because spatial intelligence tests are yet to be standardized. It is still not a fully developed field of psychology because different researchers claim that different factors influence spatial abilities. Many types of tasks, found in literature, are used to measure various spatial abilities aspects, still, some of them such as The Mental Rotation Test (MRT), The Differential Aptitude Test: Space Relations (DAT: SR), and the Mental Cutting Test (MCT) are the most common [11], [12].

To investigate if the DG has any significant impact on developing students' spatial thinking, there were several types of research conducted during the past years. In an older article written by Gittler and Gluck [13], the main goal of the research was to find the correlation between instruction in DG and pupils' performance on a spatial ability test. The test consisted of a Three-Dimensional Cube Test (3DC) and numerous variations of similar cube-connected tasks. Besides the general score, the gender difference was also taken into consideration. The researchers' results indicated that there was a difference between the first and the second test. It also indicates that the DG school subject has stimulated spatial abilities development and has helped improve pupils' spatial thinking skills [13]. The other researchers [3] have also been focusing on spatial intelligence on different levels with different approaches such as having multiple strategies in order to find the connection between science and spatial cognition. This particular research aimed to find out whether improving spatial skills affects science learning, what's the connection between science and spatial relations, and also if there is a way to spatialize the science curriculum. Spatial thinking proved to be closely connected to science success and also to be malleable. Therefore, it's possible to talk about new and improved

strategies that can possibly help students to overcome spatial orientation, visualization, and manipulation problems [3].

Various studies have been conducted in the previous years at the Faculty of Architecture, Civil Engineering, and Geodesy in Banja Luka (ACEG) and the main questions of these studies were usually about the existence of any kind of significant connection between the spatial skills of the students and the Descriptive Geometry course they were attending. Also, it was investigated if there were any differences between students of different departments at the faculty. The test used for those research combines the four most common spatial ability tasks mentioned above: MRT, DAT: SR, and MCT [11], [12].

In these researches, DG was observed as a tool supposed to help students develop their spatial abilities. The first group of students didn't attend the DG course while the other one did, during the same semester. Besides this main question, the other topics following the research were trends in improving spatial abilities, proper tools and teaching approaches that may be used to improve spatial abilities, other influential factors, and the potential improvement in spatial abilities based on gender differences. It was concluded that DG has some impact, and it may stimulate spatial thinking rather than improve spatial abilities directly. By all means, the important tool that DG provides is the capability of developing multiple cognitive processes such as deduction, abstraction, and systematization [11].

The preparatory course for enrollment at the FACEG, aside from Descriptive Geometry, was also considered an important factor that may influence the development of spatial abilities [14]. The reason why the preparatory course was selected instead of the DG course was because of the different types of tasks that are included within the preparatory course. DG has its own methodology and the tasks consisted in it are mostly abstract – with the coordinate systems, points, lines, and planes. The preparatory course, on the other hand, consists of 3D figures and 2D shapes that are more likely to be imagined and mentally manipulated. The results of the entering exam were in favor of those students who took the preparatory course at the faculty. They showed significantly better performance, unlike the students who were preparing for the exam by themselves [14].

This paper focuses also on the DG course and its role in spatial thinking progress, however, the focus group is only architecture students, since the previous studies showed a significant difference in performance between students of different departments, in favor of architecture students. For that matter, the research was redirected to analyzing the results of architecture students exclusively. In this paper, two groups of participants will be examined and compared. The first group consists of the last two generations of architecture students, while the control group consists of three generations of students who did the SA test without attending the DG course during the research period.

This research is going to show if the course of DG helps with developing and improving students' spatial abilities. Also, after analyzing the general results based on the students' scores, the paper will discuss the results of individual tasks in the spatial ability test and compare them between the two research groups.

2. METHODOLOGY AND RESEARCH

2.1. METHODOLOGY OF THE RESEARCH

Teaching methods and materials are constantly changing due to upgrading and reevaluating the knowledge that students are expected to acquire. Nevertheless, teaching experience shows that the best skill students can gain during their studies is divergent thinking [11] and the capacity to manage multiple data, identify the problem, and search for the necessary information. Therefore, spatial abilities could be an essential starting point to evolve this kind of thinking.

DG course is one of the subjects that involve spatial thinking in the process of solving different geometry problems. The semester lasts for 15 weeks, and the DG course takes 4 hours a week (2 hours of theoretical lectures combined with small tasks + 2 hours of drawing assignments). The very beginning of the course tends to introduce students to Monge's projections and basic theoretical information about points, lines, planes, and solids. The first assignments are principally basic, but the tasks are getting more difficult as the study material becomes more complex. All of the tasks are drawn by hand, so the students learn to use drawing tools such as pencils, triangles, rulers, and compass. A significant number of students struggle with the DG course, they consider it as one of the most difficult subjects in the first year of studies [11].

In this, as in the previous studies, the same SA tests were used. This test contained 8 tasks sorted into 4 types, each with 2 levels of difficulty based on the most common SA tasks mentioned above (MRT, DAT: SR, and MCT). The first group of 4 tasks is less complex than the second group of 4

tasks. Every task was valued by max. 1 point, so the maximum score on each test was 8 points. The tests' content and complexity levels are already thoroughly presented and explained in [11], [12], [15].

The test was given to the students at the beginning and at the end of the semester. These two tests are not identical, but the structure, task types, and difficulty are the same. It is a multiple-choice test. The differences between the two groups of students are compared in relation to attending the DG course between the two tests.

Since the FACEG was formed, the DG course was held during the first semester of the Civil Engineering and Geodesy study curriculum, while the Architecture students attended the DG course in the second semester, thus the architecture students were considered as the control group in the previous studies concerning spatial abilities. The study curriculum at the Architecture department changed in 2020, and since then the DG course was held during the first semester of Architecture. The other courses remained essentially the same, some of them were combined into one course, but the teaching material hasn't fundamentally changed.

This research put its focus only on students of architecture because they have usually shown better performance on the SA test in comparison to the other two departments at FACEG [11], so comparing them mutually should give more relevant results.

The first group consists of 121 students in the following school academic years: 2017/18, 2018/19, and 2019/20. The second group consists of 108 students attending the same semester during the 2020/21 and 2021/22 academic years. Both genders were represented in both groups.

For each generation of the students, the tests were conducted in the classrooms, during the teaching period, hence the students were taking tests right before or after the lessons. The duration of the tests was approximately 25 minutes.

The students were not paid for participating in the study, it wasn't conditioned by any matter.

For the statistical study, the SPSS v.20 was used as the analytical-statistical software package. Descriptive statistics were used for presenting and summarizing data. Also, the Paired Samples t-Test, non-parametric Mann-Whitney U test, χ^2 square test, and the Spearman's rank correlation coefficient were used. No normal distribution was noticed by the variables that were observed [16].

2.2. RESEARCH QUESTIONS

The leading questions concerning this specific paper were:

RQ1. Does the DG course influence the performance of architecture students at the SA test, that is, does it improve their spatial thinking?

Students were tested twice during the research period, at the beginning and at the end of the semester, as stated above. To determine if the DG had an influence on students' spatial thinking, we used a control group of students that did not attend the DG course between the first and the second test. The comparison between the results showed the difference in the performance of the two groups. In this case, we compared the difference in success on both tests between these two groups.

In the second phase, the analysis was extended to the assessment of the student's performance on the different tasks' complexity.

RQ2. Does the DG course have an impact on improving any specific spatial thinking factor or complexity of spatial skills?

In order to discover if DG provided any valuable assets for architecture students, we also compared their performance on different types and complexity of tasks. For example, the performance and the achieved results on the first test's low-complexity tasks were compared to the same complexity level tasks in the second test. The same comparison was performed with the high-complexity tasks.

The analysis is going to show if the progress was partially developed depending on the task complexity or the type of the tasks.

3. RESULTS AND DISCUSSION

Out of 318 architecture students in the first year of the Faculty of Architecture, Civil Engineering and Geodesy at the University of Banja Luka enrolled in 2017/18, 2018/19, 2019/20, 2020/21, and 2021/22 academic years, a total of 229 students were tested. The first group (Group 1) consists of students of 2017/18, 2018/19, and 2019/20 generations, who were not attending the DG course between the two tests, and the second group (Group 2) consists of the 2020/21 and 2021/22 generations, who took the DG course between the two SA tests. All students were observed and tested in the first semester of the year they were enrolled in. Students took the first (initial) spatial ability test – TEST 1 at the beginning of the first semester and the second (control) spatial ability

test – TEST 2 at the end of the first semester. The tests were not only a tool used to estimate students' abilities, but they could also be a way to gain experience and training in spatial thinking [15].

Table 1. The number of students by years of enrollment

		Total	Having DG course during the high school	NOT having DG course during the high school
Group 1	2017_18_19	Count	121	80
		% of Total	52,8 %	34.9%
Group 2	2020_21	Count	108	74
		% of Total	47,2 %	32.3%
Total	2017_18_19_20_21	Count	229	154
		% of Total	100 %	67.2%

Table 1 presents the total number of the observed students along with the percentage, 100% (229). Also, it is shown how many students were included in both Group 1, 52.8 % (121), and Group 2, 47.2% (108). The distribution of the students is adequate and nearly equal.

Before enrolling in the faculty, students attended different high schools, where some of them attended the DG course for one or two years. Table 1 shows that, out of the total number of students, 32.8% of them were engaged in the DG course during high school, and 67.2% of them were not. Out of the total number of the observed students, 175 (76.4%) are female and 54 (23.6%) are male.

3.1. PROGRESS CONCERNING GROUPS AND TESTS (TEST 1 AND TEST 2)

Table 2. The overall success of the groups in test 1 (initial test) and test 2 (control test)

		N	Mean	Std. Deviation	Median	Minimum	Maximum
TEST1	G1 (2017_18_19)	108	0.5878	0.20294	0.6250	0.00	1.00
	G2 (2020_21)	121	0.5330	0.19791	0.5313	0.00	0.88
	Total	229	0.5620	0.20201	0.5625	0.00	1.00
TEST2	G1 (2017_18_19)	108	0.6472	0.20330	0.6250	0.25	1.00
	G2 (2020_21)	121	0.5799	0.21597	0.6250	0.06	1.00
	Total	229	0.6154	0.21161	0.6250	0.06	1.00

Table 2 shows the results of both tests that students took. According to the given results, when comparing the success on the **initial** test, Group 1 showed better performance, they achieved 58.78% of the total score, while Group 2 achieved 53.3%. This implies that there could be differences in student performance compared between each generation of the students or possible differences based on the background of the student's previous education.

This can also lead to more discussion about the conditions the test was conducted. Due to the pandemic situation in 2020, some of the students were tested online, or in smaller groups. These changes in testing conditions could influence the student's performance on the test. It also raises another issue —lack of self-confidence can decrease the capacity of the student to perform as well as he/she is actually capable of, which is also an issue when observing any intelligence tests.

However, when analyzing both groups' performance on the control test, it's evident that Group 1 showed better results once again. Group 1 achieved 64.7% of the total score, while Group 2 achieved 58%. This means that both of the groups made significant progress between the first and the second test, but it also means that the DG course may not have influenced the development of their spatial abilities. When comparing the percentage of the progress these students made during the semester, it is obvious that Group 1, besides being better overall, made still greater progress. The score difference between test 1 and test 2 for Group 1 was 6%, and for Group 2 it is 4.7% (Figure 1).

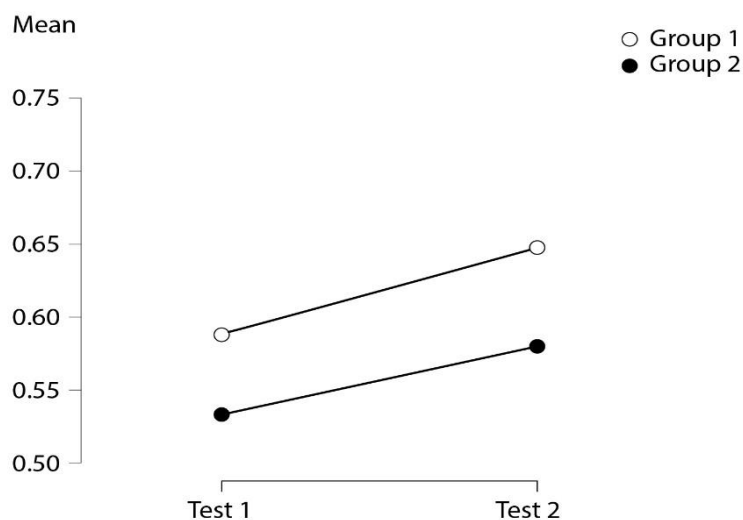

Figure 1. Progress between test 1 and test 2 for both Group 1 and Group 2

Table 2 also shows that Group 1 had at least one student who achieved a maximum score on both tests, while Group 2 achieved a maximum score only on test 2.

The Paired Samples t-Test showed a statistically significant difference in success between the first and second spatial ability tests in all students together ($t=-3.510$, $df=228$, $p=0.001$). Students achieved better scores in the second test (Table 2). There is also a mean positive correlation between Test 1 and Test 2 ($r_s=0.373$, $p=0.000$).

Analyzing each group separately, the Paired Samples t-Test showed a statistically significant difference in success between the first and second spatial ability tests for Group 1 ($t=-2.765$, $df=120$, $p=0.007$) and for Group 2 ($t=-2.165$, $df=107$, $p=0.033$). There is also a positive correlation between Test 1 and Test 2 for both groups, for Group 1 ($r_s=0.315$, $p=0.000$), and for Group 2 ($r_s=0.415$, $p=0.000$).

The Mann-Whitney U test did not show a statistically significant difference in success on the Test 1 between students of Group 1 ($N = 108$, $Md = 0.6250$) with Group 2 ($N = 121$, $Md = 0.5313$), ($U = 5635.000$, $z = -1.810$, $p = 0.70$), but did on the Test 2 ($U = 5410.000$, $z = -2.264$, $p = 0.024$).

Statistically, the results show that DG doesn't have much to do with the development of spatial abilities. The reason for this could be found in the fact that the types of tasks students solve within the DG course are not directly connected with the tasks included in spatial ability tests, but they possibly do stimulate spatial thinking. Another problem could be the strategy students use while solving DG problems. Some of them actually use spatial relations and genuine understanding when passing the course, while the rest of them rely on learning the steps and repetitive procedures without trying to understand the spatial processes behind the procedure.

Both groups did show progress in performance, it is possible to go deeper in observing the difference in the level of complexity and type of the tasks.

3.2. PROGRESS CONCERNING COMPLEXITY LEVEL – LOW AND HIGH-COMPLEXITY TASKS

The Paired Samples t-Test showed a statistically significant difference in success between low-complexity tasks and high-complexity tasks on Test 1 for all the students, ($t=15.048$, $df=228$, $p=0.000$). They generally showed significantly better performance on low-complexity tasks.

The t-test also showed a statistically significant difference between low-complexity tasks and high-complexity tasks by groups, for Group 1 ($t=12.037$, $df=120$, $p=0.000$) and for Group 2 ($t=9.278$, $df=107$, $p=0.000$). Table 4 presents that students in each group showed significantly better performance on low-complexity tasks. The Mann-Whitney U test **did show** statistically significant difference in success at the low-complexity tasks in Test 1 between Group 1 ($N = 121$, $Md = 0.75$) and Group 2 ($N = 108$, $Md = 0.75$) ($U = 5507.500$, $z = -2.095$, $p = 0.036$), but **not** at high-complexity tasks between Group 1 ($N = 121$, $Md = 0.50$) and Group 2 ($N = 108$, $Md = 0.375$) ($U = 5986.500$, $z = -1.112$, $p = 0.266$) (Table 3).

Table 3. Overall success in the initial test by task complexity – low and high-complexity

		N	Mean	Std. Deviation	Median	Minimum	Maximum	
Low-complexity tasks	TEST1_LL	G1 (2017_18_19)	121	0.7479	0.24366	0.75	0.00	1.00
		G2 (2020_21)	108	0.6759	0.27077	0.75	0.00	1.00
		Total	229	0.7140	0.25875	0.75	0.00	1.00
	TEST2_LL	G1 (2017_18_19)	121	0.6374	0.24442	0.75	0.00	1.00
		G2 (2020_21)	108	0.5903	0.26077	0.6250	0.00	1.00
		Total	229	0.6152	0.25281	0.6250	0.00	1.00
High-complexity tasks	TEST1_HL	G1 (2017_18_19)	121	0.4277	0.25656	0.50	0.00	1.00
		G2 (2020_21)	108	0.3900	0.23724	0.3750	0.00	1.00
		Total	229	0.4099	0.24781	0.3750	0.00	1.00
	TEST2_HL	G1 (2017_18_19)	121	0.6570	0.26689	0.75	0.00	1.00
		G2 (2020_21)	108	0.5694	0.24667	0.50	0.13	1.00
		Total	229	0.6157	0.26070	0.6250	0.00	1.00

The Paired Samples t-Test **did not** show a statistically significant difference in success between low-complexity level tasks and high-complexity level tasks on Test 2 for all students together ($t=-0.028$, $df=228$, $p=0.977$) nor by groups. For Group 1 ($t=-0.695$, $df=120$, $p=0.489$) and for Group 2 ($t=0.812$, $df=107$, $p=0.419$).

The Mann-Whitney U test **did not** show statistically significant difference in success at the low-complexity level tasks in Test 2 between Group 1 ($N = 121$, $Md = 0.75$) and Group 2 ($N = 108$, $Md = 0.625$) ($U = 5940.000$, $z = -1.208$, $p = 0.227$), but **did show** at the high-complexity level tasks between Group 1 ($N = 121$, $Md = 0.75$) and Group 2 ($N = 108$, $Md = 0.50$) ($U = 5234.000$, $z = -2.654$, $p = 0.008$) (table 3). The first group showed better performance at high-complexity level tasks. There is also a positive correlation between TEST1_LL and TEST1_HL for Group 1 ($r_s=0.343$, $p=0.000$) but not for Group 2. There is also a positive correlation between TEST2_LL and TEST2_HL for Group 1 ($r_s=0.265$, $p=0.003$) and for Group 2 ($r_s=0.477$, $p=0.000$).

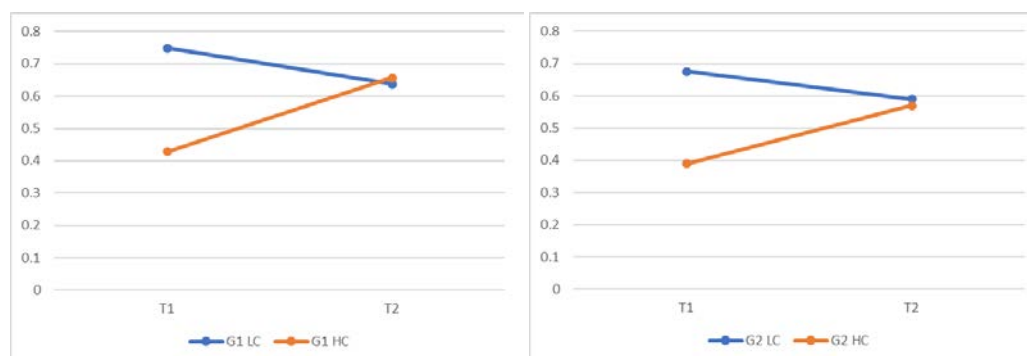

Figure 2. Difference between success on low and high-complexity tasks for Group 1(left) and Group 2(right) on test 1 and test 2

Since we found no significant connection between the DG course and the SA test, we will discuss a few observations comparing the progress of each group regarding the tasks' complexity.

Figure 2 shows that both groups decreased in success for low complexity tasks, but also both groups show progress regarding the high complexity tasks between two tests. It is interesting to notice that both groups achieved nearly the same score for both complexity levels in test 2 (Figure 3).

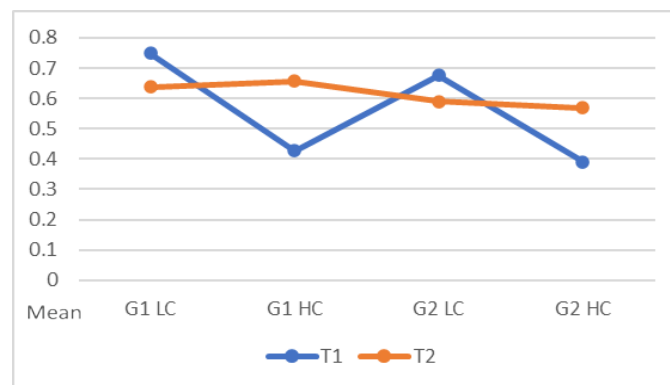

Figure 3. Score differences between two tests by complexity for both groups

These results show that low-complexity tasks are generally solved better on test 1 but repeatedly, Group 1 showed better performance. When observed more closely, there is an appreciable difference in the gap between low-complexity and high-complexity tasks' scores. Figure 4 illustrates that even if Group 1 was more successful overall, the gap between scores on high-complexity tasks is significantly smaller than between scores on low-complexity tasks. The difference between the success of Group 1 and Group 2 for low-complexity tasks is 7.2%, but only 3.7% for high-complexity tasks. According to the previous results about evident progress for both of the groups, the question is if Group 2 managed to catch up with Group 2 with at least low-complexity level tasks on test 2?

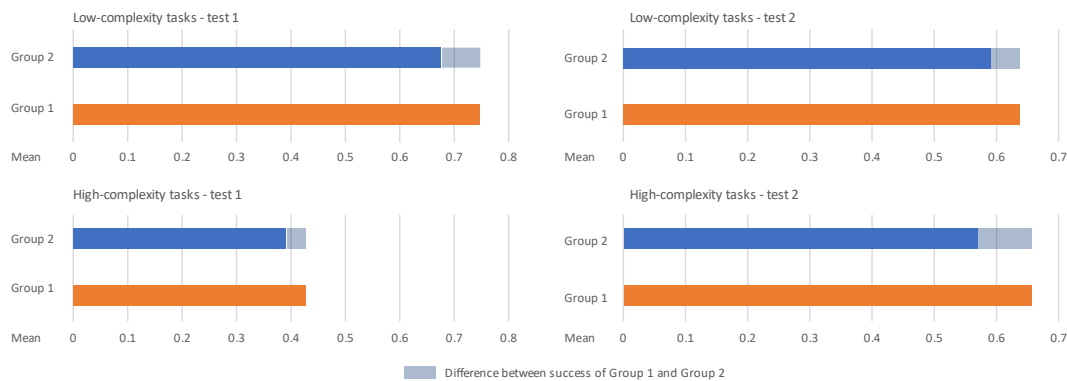

Figure 4. Success differences between groups on low-complexity tasks and high-complexity tasks on test 1 (left) and test 2 (right)

These data are confirming the general observation – that both groups made similar progress during the first semester. The question from the discussion above, about groups' progress on test 2, may be resolved by analyzing data from Table 3 and Figure 4. As expected, Group 1 achieved better results, but this time it's possible to discuss if the progress Group 1 made between test 1 and test 2 may have been lower than expected. That is, on test 1, low-complexity tasks were solved much better than high-complexity tasks, still, on test 2 that wasn't the case. Both complexity tasks were solved nearly the same, but as noticed, Group 1 improved in solving high-complexity tasks but kept almost the same score as before on low-complexity tasks. Group 2 caught up with Group 1 in solving low-complexity tasks but was left behind with high-complexity tasks. The performance difference between G1 and G2 on low-complexity tasks, on test 2 is 4.7%, and on high-complexity tasks is 8.8%.

3.3. PROGRESS CONCERNING TASK TYPE

Besides complexity, tasks are grouped 2 by 2, for example, task 1 and task 5 are the same types but have a different level of complexity. Tasks 1 and 5 are PF type (Paper folding), tasks 2 and 6 are MR (Mental Rotation) type, tasks 3 and 7 are MC type (Mental Cutting) and tasks 5 and 8 are SR (Spatial Relation) type.

Table 4. The success of each group by task types in test 1 and test 2

	N	Mean	Std.Deviation	Median	Minimum	Maximum	
TEST 1	G1_1-5	121	0.4711	0.27612	0.50	0.00	1.00
	G2_1-5	108	0.4676	0.27576	0.50	0.00	1.00
	G1_2-6	121	0.5992	0.36297	0.50	0.00	1.00
	G2_2-6	108	0.5556	0.29862	0.50	0.00	1.00
	G1_3-7	121	0.7107	0.30105	0.50	0.00	1.00
	G2_3-7	108	0.5833	0.36494	0.50	0.00	1.00
	G1_4-8	121	0.5702	0.34944	0.50	0.00	1.00
	G2_4-8	108	0.5255	0.36803	0.50	0.00	1.00
TEST 2	G1_1-5	121	0.6364	0.34761	0.50	0.00	1.00
	G2_1-5	108	0.5926	0.36906	0.50	0.00	1.00
	G1_2-6	121	0.8017	0.26987	1.00	0.00	1.00
	G2_2-6	108	0.7014	0.29887	0.75	0.00	1.00
	G1_3-7	121	0.4669	0.33376	0.50	0.00	1.00
	G2_3-7	108	0.4190	0.39392	0.50	0.00	1.00
	G1_4-8	121	0.6839	0.31585	0.50	0.00	1.00
	G2_4-8	108	0.6065	0.34890	0.50	0.00	1.00

Both test 1 and test 2 are analyzed. The χ^2 square test showed a statistically significant difference in success between G1 and G2 for tasks T1_2_6 ($\chi^2=14.842$, $p=0.005$) in favor of G1, and for T1_4_8 ($\chi^2=10.633$, $p=0.005$), also in favor of G1.

χ^2 square test showed a statistically significant difference in success between G1 and G2 in favor of G1 for T2_3_7 tasks ($\chi^2=10.435$, $p=0.015$).

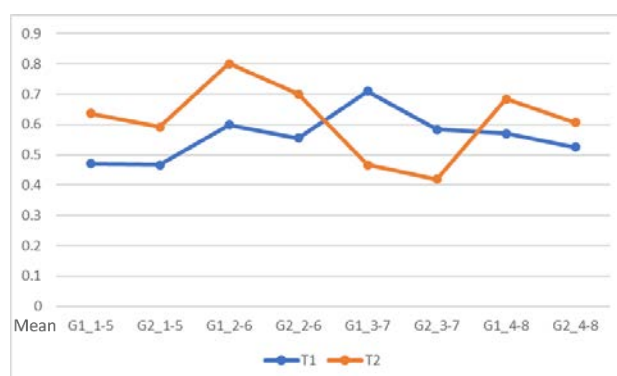

Figure 5. Success differences between test 1 and test 2 by task types

Figure 5 shows that both groups' success varied in the same direction on the same task types comparing the two tests. Comparing their performance on test 1 and test 2, they made progress in PF, MR, and SR task types, but their scores noticeably decreased on MC type.

4. CONCLUSION

For many years, much of the research on spatial abilities have been focused on the impact of the DG course on spatial skills between the three departments on FACEG – architecture, civil engineering, and geodesy. Those results have shown obvious inequalities in spatial skills between these students, mostly in favor of architecture students.

They generally performed better at the SA test which may have been due to their preparations for the entry exam in FACEG, when they encountered the spatial abilities training before they enrolled [10]. Because of that, the focus of this research was the improvement of spatial ability skills of architecture students, depending on if they attended the DG course.

The results of the study showed that both groups (with and without DG course) demonstrated a significant increase in spatial thinking during the semester in general, but there was no statistically shown impact of DG. Both groups made progress, G1 by 6% and G2 by 4.7%.

Analyzing tests by task types, the study shows the progress for both groups in all task types, except the Mental Cutting type. Similar results have been shown in previous research [11].

Results also show an interesting balance of all scores on the second test for both groups, that is, the scores for both low and high complexity tasks converge to the same value.

This may lead us to the conclusion that studies of architecture all together influence spatial thinking, and the combination of all the courses the students are attending may have an impact on improving their spatial skills. Observing those courses closely and examining their impact on spatial abilities could be the potential base for further research in this subject.

LITERATURE

- [1] N. Cross, "DESIGN THINKING UNDERSTANDING HOW DESIGNERS THINK AND WORK."
- [2] D. H. Uttal and C. A. Cohen, "Spatial Thinking and STEM Education. When, Why, and How?," in *Psychology of Learning and Motivation - Advances in Research and Theory*, vol. 57, 2012, pp. 147–181. doi: 10.1016/B978-0-12-394293-7.00004-2.
- [3] N. S. Newcombe, "Thinking spatially in the science classroom," *Current Opinion in Behavioral Sciences*, vol. 10. Elsevier Ltd, pp. 1–6, Aug. 01, 2016. doi: 10.1016/j.cobeha.2016.04.010.
- [4] C. Leopold, "Geometry education for developing spatial visualisation abilities of engineering students Some of the authors of this publication are also working on these related projects: Nexus Network Journal: Architecture and Mathematics View project Geometry, Architecture and Music View project," 2005. [Online]. Available: <https://www.researchgate.net/publication/228908412>
- [5] M. Berkowitz, A. Gerber, C. M. Thurn, B. Emo, C. Hoelscher, and E. Stern, "Spatial Abilities for Architecture: Cross Sectional and Longitudinal Assessment With Novel and Existing Spatial Ability Tests," *Frontiers in Psychology*, vol. 11, Feb. 2021, doi: 10.3389/fpsyg.2020.609363.
- [6] L. Baranová and I. Katreničová, "Role of Descriptive geometry course in development of students' spatial visualization skills," *Annales Mathematicae et Informaticae*, vol. 49, pp. 21–32, Apr. 2018, doi: 10.33039/ami.2018.04.001.
- [7] S. A. Sorby, "Developing 3D spatial skills for engineering students," *Australasian Journal of Engineering Education*, vol. 13, no. 1, pp. 1–11, Jan. 2007, doi: 10.1080/22054952.2007.11463998.
- [8] P. Katsioloudis, V. Jovanovic, and M. Jones, "A Comparative analysis of spatial visualization ability and drafting models for industrial and technology education students," *Journal of Technology Education*, vol. 26, no. 1, pp. 88–101, 2014, doi: 10.21061/jte.v26i1.a.6.
- [9] G. Bennett, H. Seashore, and A. Wesman, "Differential aptitude tests.," 1947, Accessed: Mar. 14, 2022. [Online]. Available: <https://psycnet.apa.org/record/1948-02421-000>
- [10] G. M. Bodner and R. B. Guay, "The Purdue Visualization of Rotations Test."
- [11] M. Ilić, S. Kosić-Jeremić, and M. Stavrić, "Descriptive geometry and spatial ability-correlation and mutual impact at engineering students," *Tehnicki Vjesnik*, vol. 27, no. 6, pp. 2001–2007, 2020, doi: 10.17559/TV-20190425181038.
- [12] M. Ilic and A. Djukic, "Typology of spatial ability tests and its implementation in architectural study entrance exams," *Facta universitatis - series: Architecture and Civil Engineering*, vol. 15, no. 1, pp. 1–14, 2017, doi: 10.2298/fuace161113001i.
- [13] G. Gittler and J. Glück, "Differential Transfer of Learning: Effects of Instruction in Descriptive Geometry on Spatial Test Performance," 1998.
- [14] M. Ilić, S. Kosić-Jeremić, and D. Papaz, "CAN SPATIAL ABILITY BE TRAINED – THE ANALYSIS OF PREPARATORY COURSE FOR ENROLMENT AT THE FACULTY OF ARCHITECTURE," *САВРЕМЕНА ТЕОРИЈА И ПРАКСА У ГРАДИТЕЉСТВУ*, vol. 14, no. 1, Jun. 2020, doi: 10.7251/stp2014318i.
- [15] S. Kosić-Jeremić, "COMPARISON OF PERFORMANCE OF ENGINEERING STUDENTS IN DESCRIPTIVE GEOMETRY IN RELATION TO THEIR STUDY PROGRAM," *САВРЕМЕНА ТЕОРИЈА И ПРАКСА У ГРАДИТЕЉСТВУ*, vol. 13, no. 1, Jun. 2018, doi: 10.7251/stp1813445i.
- [16] L. Preradović and Đajić Vlado, *Analitičko-statističke tehnike u savremenim istraživanjima*. Banja Luka: Arhitektonsko-građevinski fakultet, 2011.



Milan Gavrilović, University of Novi Sad, milangavrilovic@uns.ac.rs
Igor Ruskovski, University of Novi Sad, rus_igor@uns.ac.rs
Dubravka Sladić, Faculty of technical sciences, dudab@uns.ac.rs
Aleksandra Radulović, University of Novi Sad, sanjica@uns.ac.rs
Miro Govedarica, University of Novi Sad, miro@uns.ac.rs
Dušan Jovanović, University of Novi Sad, dusanbuk@uns.ac.rs

ANALYSIS AND PREDICTION OF SPATIOTEMPORAL CHANGES OF URBAN AREAS USING NEURAL NETWORKS

Abstract

Land use/Land cover (LULC) is crucial for land management. This study shows the spatiotemporal dynamics of LULC for a wide area of Novi Sad with the emphasis on the urban area analysis. Results presented in this study aim to estimate LULC changes and predict future trends of urban area expansion in Novi Sad. Conducted study shows that in the years to come there will be a decrease in the urban area expansion compared to last 35 years.

Keywords: change detection, LULC, Landsat, neural networks, random forest

АНАЛИЗА И ПРЕДИКЦИЈА ПРОСТОРНО-ВРЕМЕНСКИХ ПРОМЕНА УРБАНОГ ПОДРУЧЈА ПОМОЋУ НЕУРОНСКИХ МРЕЖА

Сажетак

Коришћење земљишта/земљишни покривача (LULC) је од суштинског значаја за управљање земљиштем. Ова студија илуструје просторно-временску динамику LULC ширег подручја Новог Сада, са акцентом на анализу урбаних подручја. Резултати, презентовани у овом раду, имају за циљ да процене промене LULC-а и предвиде будуће трендове ширења урбаног подручја Новог Сада. Проведена студија показује да ће у наредном периоду доћи до споријег ширења урбаног подручја у односу на последњих 35 година.

Кључне ријечи: детекција промена, LULC, Landsat, неуронске мреже, random forests

1. INTRODUCTION

The landscape changes cause various transformations in the nature ecosystems and the structure of society, both physical surroundings and socioeconomic factors. Among these activities, rapid urban development is considered to be leading driver for the loss of arable land and green spaces which can greatly affect climate changes and human life in general [1-3]. Consequently, large-scale urbanization and population growth are causing LULC changes, which could potentially have negative environmental consequences.

Urbanization is a name that denotes the natural or mechanical increase of population in urban areas, the expansion of urban areas or the transformation of predominantly rural characteristics of an area into an urban area. Urbanization is causing rapid land cover change, especially in developing countries [4]. The process of urbanization implies, above all, the development of cities, and in a broader sense, all other human settlements. Urban areas tend to change drastically over a short period [5] of time due to constant urbanization. Urbanization has led to land cover change often in suburban areas as a result of rapid economic development.

Timely and accurate mapping of urban land is necessary to anticipate the resources needed for the normal functioning of the urban area [6]. Remote sensing data are useful for monitoring the spatial distribution and growth of urban areas because of their ability to provide timely and up-to-date data [7]. In the last two decades, researchers have become increasingly interested in using satellite imagery to solve the problem of urban sprawl and suburbs. During this period, numerous techniques were created for fast mapping of both land cover and urban area with the help of satellite images.

In parallel with the development boom of housing, there is also the expansion of institutional, industrial, traffic, infrastructure and other built-up areas. The development of these areas is important for overcoming the problems caused by overcrowding in cities [8].

Change detection represents a serious and challenging task in the field of remote sensing. LULC changes identification based on the satellite image classification is the most common approach for the change detection when it comes to land cover [9]. In order to compare images, pixels from both images have to be compared and this is one of the methods that can answer the question of where and what changes had happened. Multiple studies [10-14] have shown that the changes in LULC, with urban expansion having one with the biggest impact, followed by loss of forests, agricultural land, water bodies, etc., are related to the degradation of the natural environment [1]. Techniques for modeling transition potential and simulating future LULC under the influence of spatial variables have evolved rapidly. They are trying to find out where the change has taken place and where the change will potentially happen in the future [15]. Most of these models take land cover time data in consideration when estimating transition potential, which in combination with spatial variables can predict future LULC scenarios [1,16].

This paper main focus is the analysis of LULC changes in the past 35 years and simulation of the future state for the wider area of Novi Sad. The assumption is that there will be a somewhat slower urbanization and expansion of the city of Novi Sad, since the city area has drastically increased in the last 35 years, and that this trend of expansion will be transferred to greater urbanization of surrounding suburbs. In order to confirm or reject these assumptions, this research is conducted with the main goal to predict changes in land cover using the method of Multilayer Perceptron (MLP) Neural Network. As foretold, the emphasis is on the analysis of urban sprawl in the last 35 years and the simulation of urban sprawl in the next 35 years using publicly available data sets and open source tools.

2. MATERIALS AND METHODOLOGY

2.1. STUDY AREA

The area for this analysis includes the wider urban area of Novi Sad. The city of Novi Sad is located at 45°15'18"N, 19°50'41"E, and is the largest city in the Autonomous Province of Vojvodina. The town lies on the banks of the river Danube, on the left bank is the plain part of the city (Backa), while on the right bank is the hilly part of the city (Srem), located on the slopes of Fruska gora. The altitude on the Backa side is 72-80m, while on the Srem side it is about 250-350m. After Belgrade, Novi Sad is the second most populous city in the Republic of Serbia. At the last official census from 2011., the city itself had 231 798 inhabitants, while in the municipal area of Novi Sad the number of inhabitants was 341 625 [17]. Novi Sad has a very favorable geographic position, it is located on the important traffic corridors, which provides significant advantages. Its roads, rails and river are

connected to the environment. The city was also chosen as the European Capital of Culture in 2022, and as such it certainly has great potential for expansion.

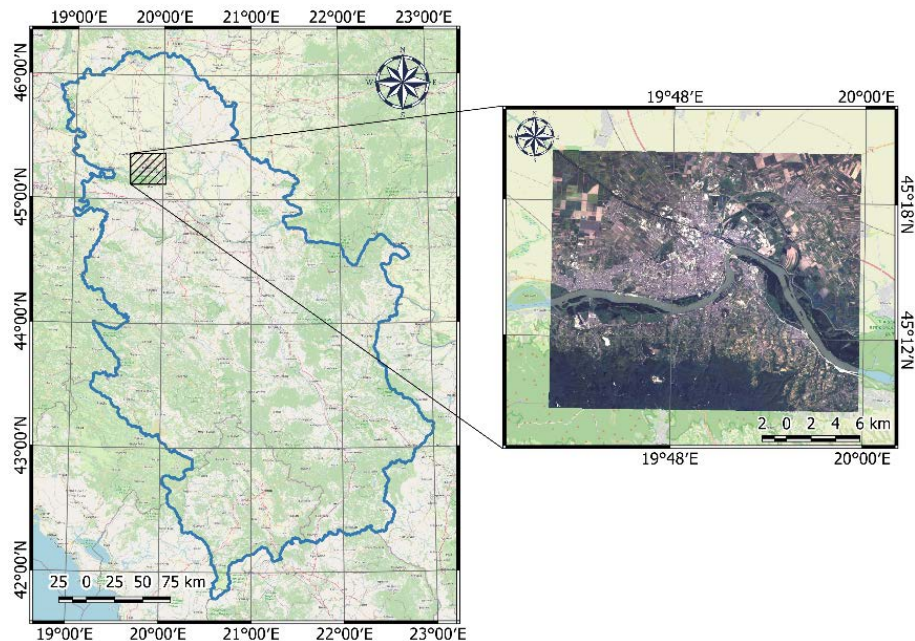

Figure 1. Study area

2.2. DATA COLLECTION

The data set for this analysis consisted of satellite images [18] used to obtain land cover maps, digital elevation model and OpenStreetMap data from which other raster data (remoteness from roads and remoteness from watercourses) representing the input parameters of the simulation model were created.

2.2.1. Landsat 5

Landsat 5 was a low-orbit Earth satellite, launched on March 1st, 1984 for the purpose of collecting images of the Earth's surface. It was a continuation of the Landsat program (Landsat 1, 2, 3 and 4 were sent into orbit before Landsat 5). After 29 years spent in space, Landsat 5 completed its mission on June 5th, 2013 [19]. It was equipped with two sensors: Thematic Mapper (TM) and Multispectral Scanner (MSS). Each shot covers an area of 185x170km. The Landsat sensor has 7 bands that simultaneously record the emitted energy from the Earth's surface in blue, green, red, near-infrared, medium-infrared and thermal infrared part of the spectrum, with spatial resolutions of 30m and 120m [20]. The platform was located at an altitude of 705km with an orbit synchronized with the Sun. It had a 16 day temporal resolution.

2.2.2. Landsat 8

Landsat 8 was launched on February 11th, 2013. It was fully developed in collaboration between two agencies, the US Geological Survey (USGS) and the National Aeronautics and Space Administration (NASA). Like the Landsat 5, the Landsat 8 also carries two types of sensors, Operational Land Imager (OLI) and the Thermal Infrared Sensor (TIRS). The OLI sensor has a spatial resolution of 30m, while the TIRS thermal sensor has a spatial resolution of 100m. TIRS data are registered together with OLI data that are of higher spatial resolutions to form radiometric and geometric corrections. Landsat 8 records in 11 bands. Of those bands, the tenth and the eleventh are thermal, data from TIRS sensors, the eighth band is panchromatic with a spatial resolution of 15m [21]. The Landsat 8 orbit is defined in relation to the Worldwide Reference System (WRS-2) and is synchronized with the Sun and is located at an altitude of 705km. The inclination of the orbit is 98.2 degrees. The satellite orbits the Earth in 98.9 minutes, and the time of crossing the equator is at 10:00 UTC +/- 15 minutes. These characteristics of the orbit allow the Landsat 8 satellite to cover the entire globe every 16 days. The approximate scene covered by one shot is 170x183km [22].

2.2.3. EU-DEM

EU-DEM is a new digital elevation model for Europe. It was developed under the Copernicus program. The aim of the program is to increase the availability and establish the basis for the height of European relief data. The model is of medium quality, with a spatial resolution of about 25m. It

is a hybrid product based on SRTM and ASTER GDEM data combined with mean value measurement approach. EU-DEM was subsequently improved by adding various data. For example, values of heights in areas where there was a large coverage by the clouds were replaced by the data from SRTM model [23]. Statistical validation of EU-DEM v1.0 shows an overall vertical accuracy of 2.9m RMSE. It is consistent with the upgraded version of EU-Hydro, in order to produce a better river network topology [24].

2.3. METHODS

As a part of this case study, the authors proposed a workflow to predict the expansion of the urban area based on data generated on the principles of remote sensing. The proposed steps are shown in Figure 2.

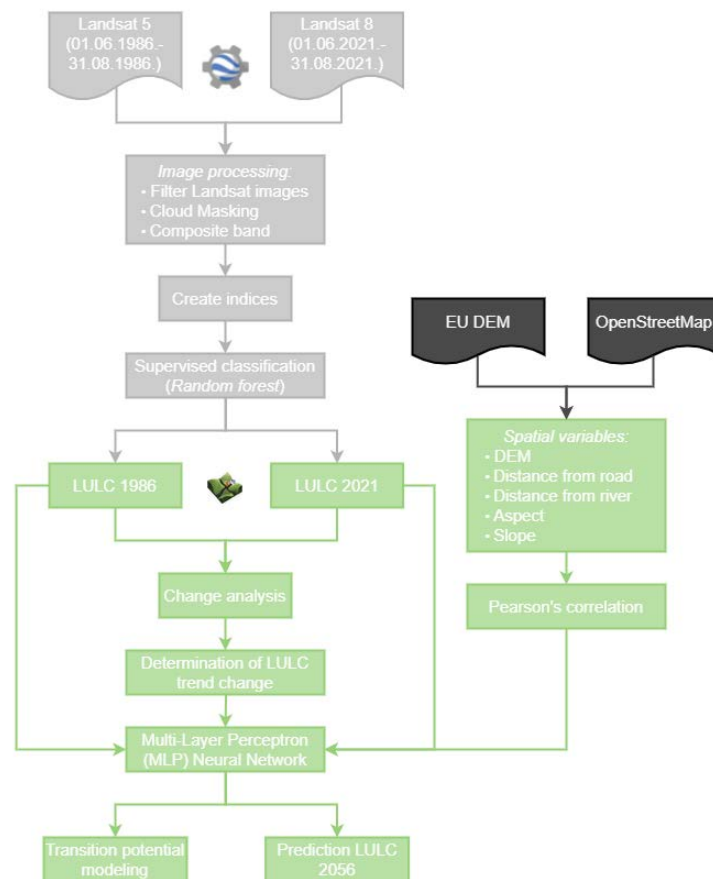

Figure 2. Flow chart of research method

2.3.1. Random forest

Random forest is a classifier from the Decision tree classifier group, which produces multiple decision trees using a randomly selected subset of patterns and variables. Random forest is a flexible machine learning (ML) algorithm that is simple, has a very wide application and gives excellent results [25]. This classifier has become popular in the field of remote sensing due to the accuracy of its classifications. It is also one of the most commonly used algorithms, due to its simplicity and the fact that it can be used for both classification and regression, making it similar to SVM. The idea of this algorithm is to train many decision trees and the decision of a class or the unknown sample value is done by voting in the case of classification or averaging the results in the case of regression. Each tree is generated by selecting a random sample from a training set, a pixel with known classes. Attributes that are relevant for classification are selected for tree nodes. In the processing of satellite images relevant attributes are bands. Not all bands are used for individual trees, but some bands are used, i.e. the number of tree nodes is less than the number of bands. For each node, based on a known sample, boundary parameters are generated that divide the sample into classes up to the last branch of the decision tree [26]. The procedure is repeated until a sufficient number of trees is generated. Each pixel of the satellite image passes through each tree that classifies it into one of the classes. In the end, the pixel is assigned to the class that a large number of trees have chosen for that pixel.

2.3.2. Change Analysis and Transition Potential Modeling

The Modules for Land-Use Change Simulation (MOULSCE) tool was used in this paper to analyse land cover change and simulate future changes. This QGIS plugin offers the ability to analyse and differentiate land cover change characteristics between two different years. In this study, the change in land cover between 1986 and 2021 was analysed in order to see the changes in spatial patterns. MOULSCE is able to calculate the transition matrix of the probability of change between any given class and generates a map that thematically shows all types of land cover change.

MOLUSCE offers methods such as Artificial Neural Network (Multi-layer Perception), Multi Criteria Evaluation, Weights of Evidence and Logistic Regression for modeling future land cover, ie. simulation of land cover in the coming period. An artificial neural network (ANN) method was used in this study. Cellular Automata Simulation was used to predict future land cover change based on 1986 and 2021 maps and additional spatial variables. What is important to note is that this model is based on the analysis of previous changes in the use and condition of neighboring cells to define the rules of transition, and not on some anthropogenic or natural processes.

2.3.3. Multi-Layer Perceptron (MLP) Neural Network Method

Artificial neural networks represent an alternative approach to solving logical problems compared to conventional computer logic. The very word "artificial" suggests that the inspiration for the structure and logic of these networks came from an attempt to imitate the work of natural neural connections and systems. Basically, the use of artificial neural networks tries to create an artificial system capable of learning and making intelligent decisions as a human being. This is especially important when it comes to the large amount of data and the short time required to process it.

The perceptron is a model of a single neuron that was the forerunner of larger neural networks. For multi-class problems, it is necessary to use more perceptrons, one for each class. The output of each perceptron represents the probability of belonging to that class, and the class with the highest probability is taken as the final output. A neural network is characterized as a Multi-layer perceptron if within the neural network there are additional layers of neurons (perceptrons) between the input and output layers, so-called hidden layers [27,28], as shown in Figure 3. The input layer receives an input signal that should be processed. The required task such as prediction and classification is performed by the output layer. An arbitrary number of hidden layers located between the input and output layers are the real computational mechanism of MLP [27]. MLPs are designed to approximate any continuous function and can solve non-linear problems [28]. MLPs are most commonly used for classification problems, recognition, prediction, and approximations.

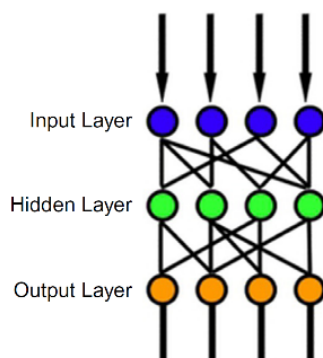

Figure 3. Schematic representation of a MLP with single hidden layer [28]

3. RESULTS AND DISCUSSION

3.1. CLASSIFICATION

In order to be able to analyse the change in land cover and the expansion of the urban area, it is necessary to classify satellite images and extract class information from them. Before the classification, a search of satellite images from two collections (Landsat 5 and Landsat 8) for the period from June to September 1986 and 2021 for the wider area of Novi Sad was performed. Clouds were removed from the images obtained in this way, and composites were created in order to obtain one image for 1986 and 2021 (Figure 4). In order to obtain better classification results, and based on the analysis of the literature that dealt with the classification of land cover [29-31], it was decided to add 5 more indices (NDVI, NDWI, NDBI, SAVI and EBBI) in addition to satellite imagery bands.

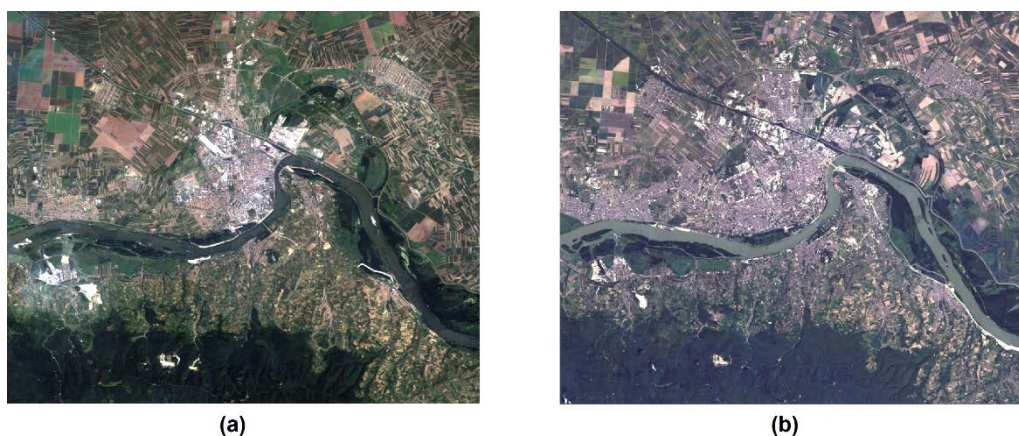

Figure 4. RGB satellite image 1986 (a) and 2021 (b)

Prior to the classification procedure, training samples were made for each of the 5 classes (water, forest, bare land, low vegetation and artificial objects), 400 for each of the two analysed years. Since the data about classes have not been available, training samples were created through the satellite images analysis. In order to claim with certainty that those pixels that represent areas of a certain class are included, optical images are visually displayed with different combinations of RGB displays of visible and infrared bands. Out of the total number of training samples, 80% were taken for training and 20% were taken for accuracy assesment.

The classification of satellite images was performed using the already implemented Random Forest algorithm within Google Earth Engine. Satisfactory classification results were obtained by minimal modification of parameters, so the number of trees for each class (numberOfTrees) was chosen to be 300, and the input of tree variables (bagFraction) was chosen to be 0.5, other parameters were left at default values. In the paper itself, as already mentioned, the emphasis is placed on the analysis of changes in land cover, ie. on the analysis of the expansion of the urban area, and for that reason no greater attention was paid to the optimization of the parameters of the classification algorithm.

The results of the satellite image classification were confirmed by estimating pixel-by-pixel accuracy based on validation points. Validation points were selected at different locations representing different land cover classes. For each classification result, an accuracy check was performed based on the error matrix and Kappa statistics of the same. An overall classification accuracy of 93.51% for 1986 and 94.59% for 2021, respectively, was obtained, with Kappa statistics of 91.79% for 1986 and 92.80% for 2021.

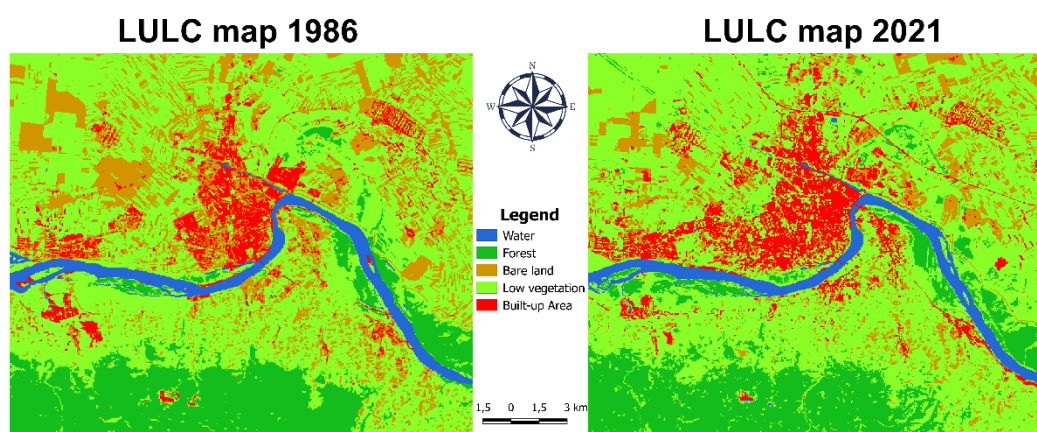

Figure 5. LULC maps 1986 and 2021

3.2. LULC CHANGE ANALYSIS

After the classification, the analysis of the change in the way of land cover in the last 35 years was performed, ie. for the period from 1986 to 2021. LULC maps classified into five LULC classes are shown in Figure 5. What can be seen from these maps is that the area occupied by artificial objects has increased significantly in the last 35 years. This increase in artificial areas is most noticeable on the western side of the city of Novi Sad, which in terms of construction resulted in the merger of

Novi Sad with the suburban settlement of Futog. The spread of other suburban settlements is also visible.

Table 1 shows the areas of each of the five analysed land cover classes, as well as their differences. It is obvious that the biggest change was experienced by bare land, which partly passed into the class of built-up areas, and partly into the class of low vegetation. Given that the classes of low vegetation and bare land can represent arable land, it is clear that the change in the way of use between these two classes will occur not only from year to year but also within one year. What can be concluded from this table is that there was a small change in water surfaces (decrease in area of 0.18%) and a slight increase in forest area of 1.28km² and 0.25%. On the other hand, the use of urban land has increased significantly by 19.83km².

Table 1. Class statistics

LULC Type	1986 [km ²]	2021 [km ²]	D [km ²]	D [%]
Water	20.20	19.29	-0.91	-0.18
Forest	86.29	87.57	1.28	0.25
Bare land	103.22	60.02	-43.20	-8.44
Low vegetation	270.57	293.57	23.00	4.49
Built-up Area	31.80	51.62	19.83	3.87

Analysis of LULC changes shows a proportional transformation of bare soil into vegetation classes and artificial objects (Figure 6). Based on the share of representation of each class, it can be clearly established that new urban areas have emerged on parts of once potentially arable land (low vegetation and bare land).

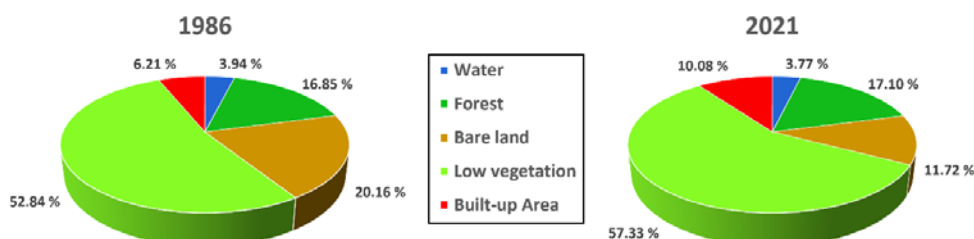

Figure 6. Different composition of land cover percentage in 1986 and 2021

Figure 7 shows the areas that now belong to the artificial objects and which in 1986 belonged to one of the other four classes. From this picture, it is noticeable that most areas where there was no vegetation were transformed into artificial surfaces. More precisely, as much as 56.17% of the total number of transformed areas on which there was bare land was transformed into artificial objects, and the rest of the area of 43.83% was transformed into other 3 classes.

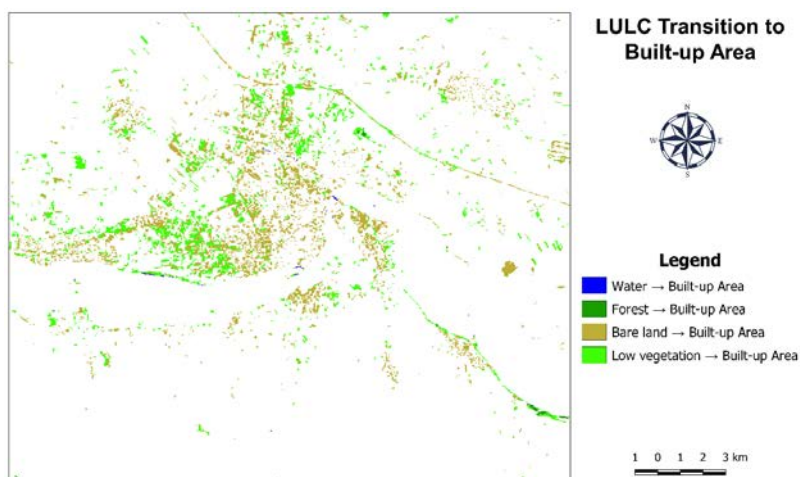

Figure 7. LULC Transition to Built-up Area

The percentage of all classes that were transformed into artificial surfaces is given in Figure 8. As already mentioned, bare land experienced the biggest change, and now it can be seen that the smallest change occurred in water surfaces, which was expected.

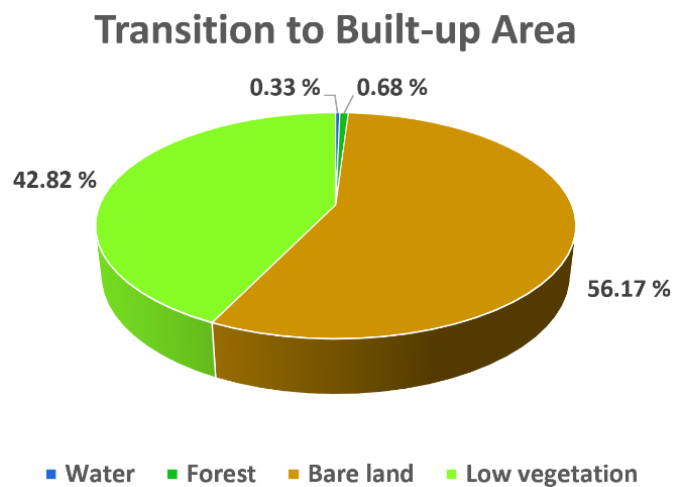

Figure 8. Percentage Transition to Built-up Area

3.3. CORRELATION EVALUATION

In order to more accurately predict the further expansion of the urban area in addition to the land cover from the two periods (maps obtained in the previous step), it is necessary to include other data that may affect the forecast result in the analysis. More precisely, the result of the forecast can be influenced by some physical and socioeconomic factors that are responsible for changes in LULC, because their contribution to the mechanism of change is very significant. Spatial factors such as the digital elevation model, aspect, slope, distance from roads and distance from watercourses can greatly influence the expansion of the urban area, so they are included in the model based on which predictions of the situation for the next 35 years will be made.

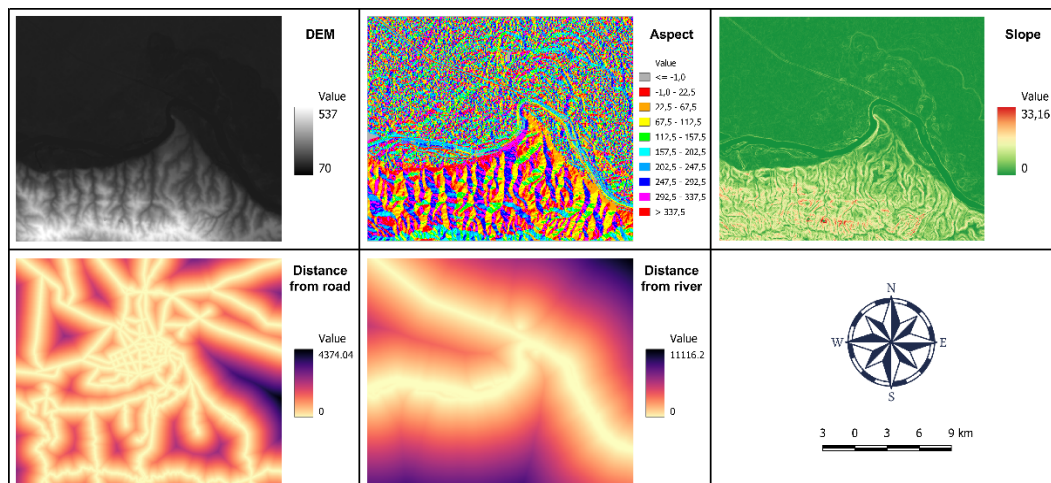

Figure 9. Spatial variables

The correlation between the spatial variables was estimated using Pearson's correlation coefficient. The correlation coefficient takes values from -1 to +1. If it takes positive values, the correlation between the phenomena is direct or positive (both phenomena show direct variations). In the case when the correlation coefficient is less than 0, the relationship is inverse or negative (when one phenomenon increases, the other decreases, and vice versa). If there is a functional connection between the observed phenomena, we are talking about a perfect correlation. The correlation coefficient in that case takes the value -1 (if the connection is inverse) or +1 (if the connection is direct). The closer the absolute correlation coefficient is to value of one, the stronger the correlation between the phenomena. In contrast, the closer to zero the weaker the linear relationship. Table 2 shows the correlation relationship between the five spatial variables. As we can see, DEM and Slope have the greatest dependence, and DEM and Aspect have the least.

Table 2. Person's correlation between spatial variables

	DEM	Aspect	Distance from road	Slope	Distance from river
DEM	--	-0.00624	-0.07703	0.75050	0.51109
Aspect		--	-0.01326	-0.01012	0.01274
Distance from road			--	-0.05230	0.06236
Slope				--	0.30852
Distance from river					--

3.4. TRANSITIONAL POTENTIAL MODELING

Based on LULC data and spatial variables, a transition probability matrix is formed, which consists of rows and columns of land classes in the initial 1986 and final 2021 year. This matrix shows the proportion of pixels that change from one type to another.

The highest probability of change of 0.176696 was observed when changing bare land into built-up land, which coincides with previous analyses. The lowest probability of change is when crossing water surfaces into bare land and it is zero, which tells us that this kind of transformation will not happen.

Table 3. Transition matrix of land cover in 1986 and 2021

		2021				
		Water	Forest	Bare land	Low vegetation	Built-up Area
1986	Water	0.888027	0.011139	0	0.095531	0.005302
	Forest	0.002076	0.823856	0.001439	0.170084	0.002545
	Bare land	0.002842	0.008405	0.209776	0.602281	0.176696
	Low vegetation	0.001956	0.056348	0.124448	0.765856	0.051392
	Built-up Area	0.011095	0.004359	0.143836	0.238367	0.602343

Once the transition matrix has been formed, the next step is to create a model to predict land cover change. During the process of model creation, LULC data from years 1986. and 2021. was used as an input, along with spatial variables and transition matrix (Table 3) in order to predict the LULC for the year of 2056. In this paper, the Multi-Layer Perceptron (MLP) neural network algorithm was used to simulate the future state, as literature analysis found that many researchers found that this approach was more powerful than other methods such as linear regression [32,33]. When creating a model, it is necessary to define several parameters, so the value of one pixel was chosen for Neighborhood pixels because it is the minimum that is the most efficient. Ten hidden layers were selected, the learning rate and momentum parameters were set to 0.001, and the training was performed in fifty iterations. After this, it was determined that the total accuracy is -0.00082, and the Min Validation Overall Error is 0.06328. In the following diagram, we see the learning curve of the model, which is obtained in the process of training the neural network.

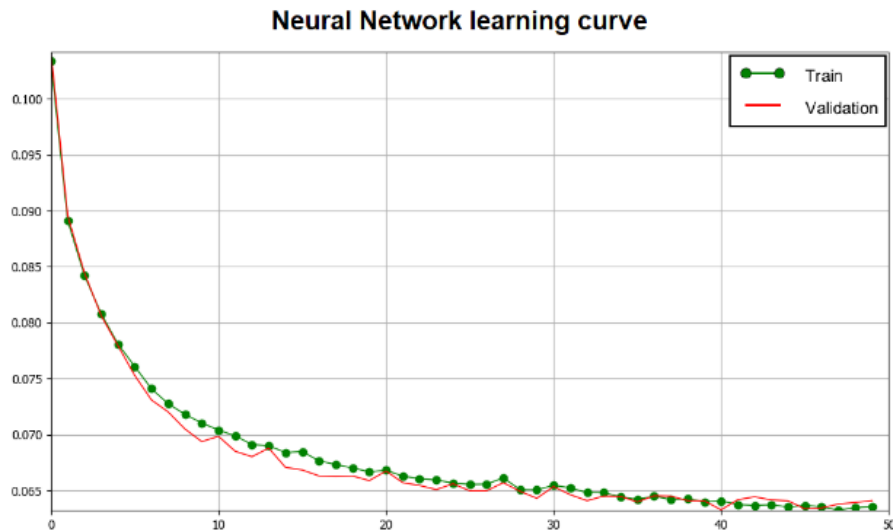

Figure 10. *Neural Network learning curve*

3.5. PREDICTION LULC

In this case, artificial neural network was used to model the transition potential, and the results generated in this way will be used in the further process, ie. in Cellular Automata Simulation. Basically, the Cellular Automata Simulation process is based on the Monte Carlo algorithm [1,10]. Future LULC maps are predicted assuming that the existing LULC pattern and dynamics continue. The simulation results are shown in the following maps. Since low vegetation and bare land have the greatest potential for change into built land, only these two types will be shown below, the other two types (water and forest) show less than 10% of the potential to move to urban areas, so they will not be further analysed.

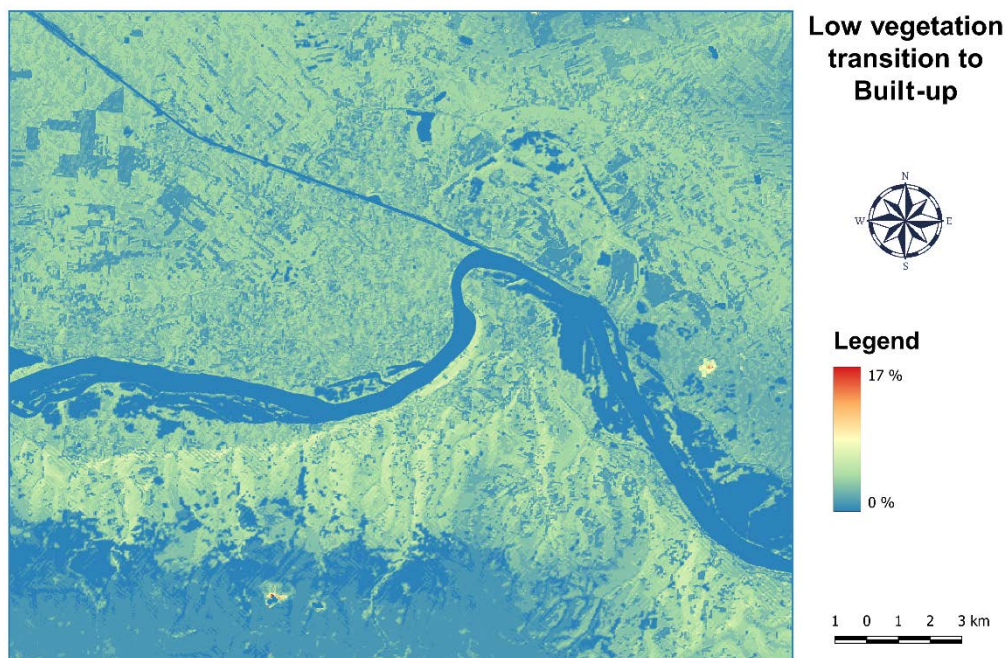

Figure 11. *Low vegetation transition to Built-up*

As Figure 11 shows, low vegetation has the same potential for change in urban areas throughout, but this potential is still below 20%, suggesting a low probability of transition from this class of land to built-up area.

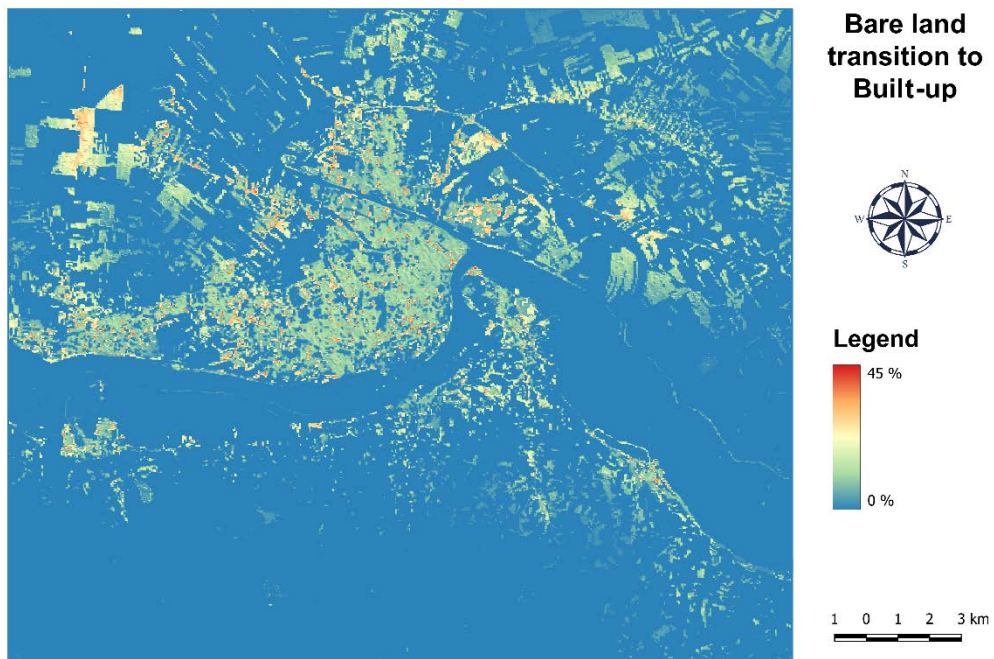

Figure 12. *Bare land transition to Built-up*

On the other hand (Figure 12), with bare land there is a greater potential for change, up to 45%, which indicates a higher probability of transition of this type of land to built-up, so it is quite realistic to expect a transition in this direction. The result of the simulation and the ultimate goal of this analysis is a map of the projected spatial distribution of artificial objects for 2056.

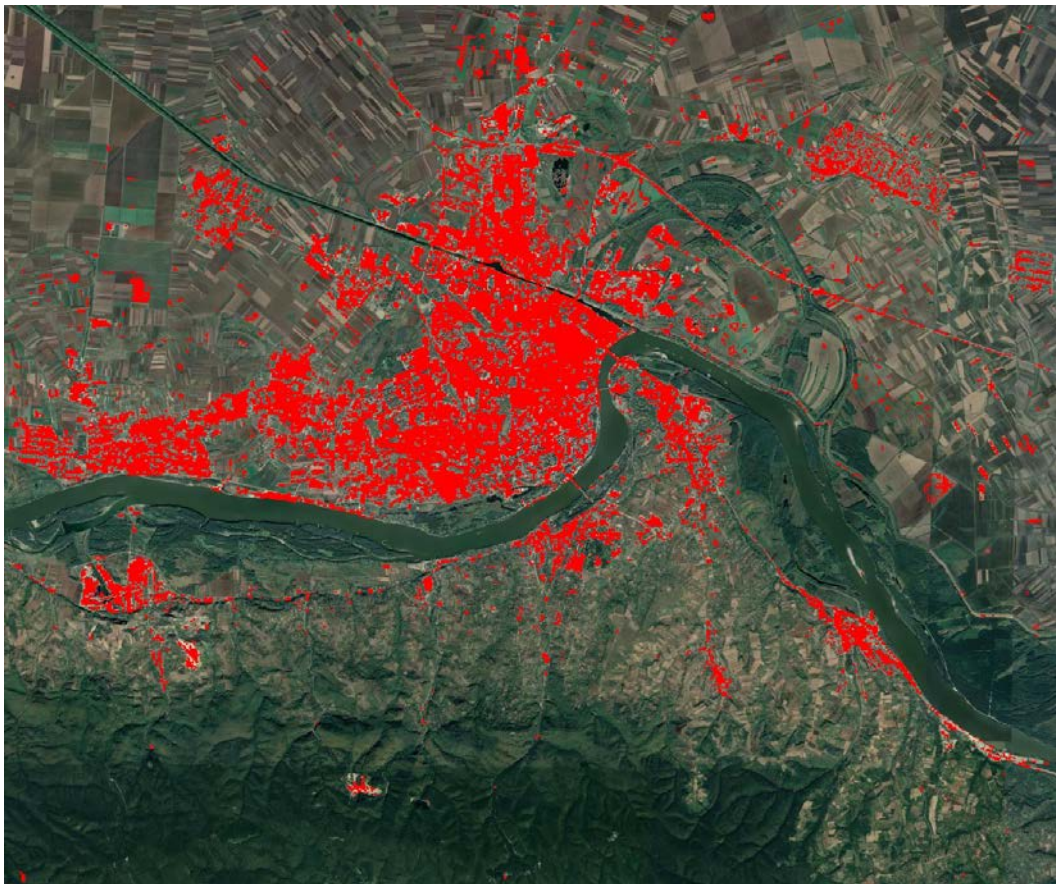

Figure 13. *Built-up area in 2056*

As it can be seen from Figure 13, in the next 35 years, slow urbanization is predicted, ie. the trend of urban expansion is weakening. Based on the calculated areas for each class, we can see that the share of artificial facilities for 2056 in the wider area of Novi Sad is 10.82%, which confirms the previous conclusion about a small increase in the urban area. This conclusion makes sense if we take into account the fact that the city has experienced a drastic expansion in the last 35 years, which has been proven in this paper, so it is to be expected that further expansion will be somewhat slower. In addition to the expansion of the city of Novi Sad, there is also a change in the area, ie. expansion of surrounding settlements.

4. CONCLUSION

LULC maps from 1986 and 2021 represent a significant source of data and as such were used to simulate changes in 2056. The results of the classification indicate a significant growth of the urban area during the analysed period, with a decrease in other types of land cover.

The results of this research show that the greatest transformation into built land, in the last 35 years, of all LULCs, has been experienced by areas under low vegetation and bare land. Specifically, the LULC class, which experienced the largest change in the decrease from 1986 to 2021, was the bare land class, which was determined to have passed most of these areas into the class of built-up areas. During the analysis of areas and representation of each class in the analysed area, it was determined that the construction area of the wider area of Novi Sad in 1986 was 31.8km², and the construction area in 2021 was 51.62km². Further analysis concludes that the area of Novi Sad has expanded by 19.83km² over 35 years. The biggest changes and urban expansion have been identified in the area of Veternik and Telep.

Spatial variables, such as Digital elevation model, Slope, Aspect and Distance and Road Distance Factors, are very important driving factors that determine the further transformation of LULC, and as such are recognized and included in the model used to simulate future conditions. The use of the Multi-Layer Perceptron (MLP) as a model to simulate the future state of LULC for 2056 using Cellular Automata Simulation has shown that the areas under artificial objects are slightly increasing compared to 2021. This result confirms the initial assumption that in the coming period there will be a slow expansion of the urban area. Additional improvements to the proposed model could be achieved by including more spatial variables that influence the change of landscape patterns, so the analysis of other physical and socio-economic factors that may be responsible for land cover change will be the subject of future research.

This study proposed a model for simulating the future expansion of the urban area, which can be of great help for planning the development of cities, ie. to create settlement regulation plans or to solve problems that arise due to various human activities. Also, the results obtained in this way can be used by planners to determine a development pattern that would allow them to make better use of land. In addition, it helps the community understand the changes in its environment, as well as other stakeholders to assess the development potential of a place. It also provides vital information to state or local authorities that are directly involved in the development of an area. By analyzing future potential developments, using publicly available data and open source tools, data obtained can be used by experts from various fields that are in some way related to spatial and temporal data.

ACKNOWLEDGMENTS

This work was financially supported by the Ministry of Education, Science and Technological Development of the Republic of Serbia Grants No. 37017.

LITERATURE

- [1] Z. Abbas, G. Yang, Y. Zhong, and Y. Zhao, "Spatiotemporal Change Analysis and Future Scenario of LULC Using the CA-ANN Approach: A Case Study of the Greater Bay Area, China," *Land*, vol. 10, no. 6, pp. 584, 2021.
- [2] R. Wang, A. Derdouri, and Y. Murayama, "Spatiotemporal Simulation of Future Land Use/Cover Change Scenarios in the Tokyo Metropolitan Area," *Sustainability*, vol. 10, no. 6, pp. 2056, 2018.
- [3] Z. Qiao, L. Liu, Y. Qin, X. Xu, B. Wang, and Z. Liu, "The Impact of Urban Renewal on Land Surface Temperature Changes: A Case Study in the Main City of Guangzhou, China," *Remote Sensing*, vol. 12, no. 5, pp. 794, 2020.

- [4] L. Jiang, Y. Liu, S. Wu, and C. Yang, "Study on Urban Spatial Pattern Based on DMSP/OLS and NPP/VIIRS in Democratic People's Republic of Korea," *Remote Sensing*, vol. 13, no. 23, pp. 4879, 2021.
- [5] Z. Wu, R. Zhou, and Z. Zeng, "Identifying and Mapping the Responses of Ecosystem Services to Land Use Change in Rapidly Urbanizing Regions: A Case Study in Foshan City, China," *Remote Sensing*, vol. 13, no. 21, pp. 4374, 2021.
- [6] S. Gao, W. Li, K. Sun, J. Wei, Y. Chen, and X. Wang, "Built-Up Area Change Detection Using Multi-Task Network with Object-Level Refinement," *Remote Sensing*, vol. 14, no. 4, pp. 957, 2022.
- [7] D. Jovanović, M. Gavrilović, D. Sladić, A. Radulović, and M. Govedarica, "Building Change Detection Method to Support Register of Identified Changes on Buildings," *Remote Sensing*, vol. 13, no. 16, pp. 3150, 2021.
- [8] C. Corbane, V. Syrris, F. Sabo, P. Politis, M. Melchiorri, M. Pesaresi, P. Soille and T. Kemper, "Convolutional neural networks for global human settlements mapping from Sentinel-2 satellite imagery," *Neural Computing and Applications*, vol. 33, pp. 6697, 2021.
- [9] D. Jovanović, M. Govedarica, F. Sabo, Ž. Bugarinović, O. Novović, T. Beker and M. Lauter, "Land cover change detection by using remote sensing: A case study of Zlatibor (Serbia)," *Geographica Pannonica*, vol. 19, no. 4, pp. 162, 2015.
- [10] N. Alam, S. Saha, S. Gupta, and S. Chakraborty, "Prediction modelling of riverine landscape dynamics in the context of sustainable management of floodplain: a Geospatial approach," *Annals of GIS*, vol. 27, no. 3, pp. 299, 2021.
- [11] C. Liping, S. Yujun and S. Saeed, "Monitoring and predicting land use and land cover changes using remote sensing and GIS techniques—A case study of a hilly area, Jiangle, China," *PLOS ONE* vol. 13, no. 7, 2018.
- [12] C. Başnou, E. Álvarez, G. Bagaria, M. Guardiola, R. Isern, P. Vicente and J. Pino, "Spatial Patterns of Land Use Changes Across a Mediterranean Metropolitan Landscape: Implications for Biodiversity Management," *Environmental Management*, vol. 52, pp. 971, 2013.
- [13] X. Jianchu, J. Fox, J. B. Vogler, Z. P. F. Yongshou, Y. Lixin, Q. Jie and S. Leisz, "Land-Use and Land-Cover Change and Farmer Vulnerability in Xishuangbanna Prefecture in Southwestern China," *Environmental Management*, vol. 36, pp. 404, 2005.
- [14] N. Gamboa-Badilla, A. Segura, G. Bagaria, C. Basnou and J. Pino, "Contrasting time-scale effects of land-use legacy on species richness, diversity and composition in Mediterranean scrubland communities," *Landscape Ecology*, vol. 35, pp. 2745, 2020.
- [15] S. W. Wang, B. M. Gebru, M. Lamchin, R. B. Kayastha, and W. K. Lee, "Land Use and Land Cover Change Detection and Prediction in the Kathmandu District of Nepal Using Remote Sensing and GIS," *Sustainability*, vol. 12, no. 9, pp. 3925, 2020.
- [16] M. Kamaraj and S. Rangarajan, "Predicting the Future Land Use and Land Cover Changes for Bhavani Basin, Tamil Nadu, India Using QGIS MOLUSCE Plugin," *Environmental Science and Pollution Research*, 2022.
- [17] Statistical Office of the Republic of Serbia, <https://www.stat.gov.rs/en-US/>, [12.02.2022.].
- [18] D. Jovanović, M. Govedarica, F. Sabo and D. Sladić, "Open Satellite Data for the area of Serbia," in *ICIST 2015 5th International Conference on Information Society and Technology*, 2015.
- [19] Landsat 5, <https://www.usgs.gov/landsat-missions/landsat-5>, [15.02.2022.].
- [20] A. Sekertekin and S. Bonafoni, "Land Surface Temperature Retrieval from Landsat 5, 7, and 8 over Rural Areas: Assessment of Different Retrieval Algorithms and Emissivity Models and Toolbox Implementation," *Remote Sensing*, vol. 12, no. 2, pp. 294, 2020.
- [21] Landsat 8, <https://landsat.gsfc.nasa.gov/satellites/landsat-8/>, [15.02.2022.].
- [22] M. A. Ridwan, N. A. M. Radzi, W. S. H. M. W. Ahmad, I. S. Mustafa, N. M. Din, Y. E. Jalil, A. M. Isa, N. S. Othman and W. M. D. W. Zaki, "Applications of Landsat-8 Data: a Survey," *International Journal of Engineering & Technology*, vol. 7, no. 4, pp. 436, 2018.
- [23] A. Šiljeg, M. Barda, I. Marić, *Digitalno modeliranje reljefa*. Sveučilište u Zadru, Alfa d.d., Zadar, Zagreb, 2018.
- [24] EU-DEM, <https://land.copernicus.eu/imagery-in-situ/eu-dem>, [17.02.2022.].
- [25] M. Belgiu and L. Drăguț, "Random forest in remote sensing: A review of applications and future directions," *ISPRS Journal of Photogrammetry and Remote Sensing*, vol. 114, pp. 24, 2016.

- [26] G. Jakovljević, D. Sekulović and M. Govedarica, "Land use / land cover mapping from sentinel 2 data using machine learning algorithms," in *STEPGRAD International scientific conference on contemporary theory and practice in construction XIII*, pp. 247, 2018.
- [27] F. Murtagh, "Multilayer perceptrons for classification and regression," *Neurocomputing*, vol. 2, no. 5–6, pp. 193, 1991.
- [28] S. Abirami and P. Chitra, "Chapter Fourteen - Energy-efficient edge based real-time healthcare support system," *Advances in Computers, Elsevier*, vol. 117, no. 1, pp. 339, 2020.
- [29] Abd. R. As-syakur, I. W. S. Adnyana, I. W. Arthana, and I. W. Nuarsa, "Enhanced Built-Up and Bareness Index (EBBI) for Mapping Built-Up and Bare Land in an Urban Area," *Remote Sensing*, vol. 4, no. 10, pp. 2957, 2012.
- [30] A. Taufik and S. S. S. Ahmad, "Land cover classification of Landsat 8 satellite data based on Fuzzy Logic approach," in *8th IGRSM International Conference and Exhibition on Remote Sensing & GIS*, 2018.
- [31] M. Ukhnaa, X. Huo and G. Gaudel, "Modification of urban built-up area extraction method based on the thematic index-derived bands," in *IOP Conference Series Earth and Environmental Science* 227, 2019.
- [32] M.T.U. Rahman, F. Tabassum, M. Rasheduzzaman, H. Saba, L. Sarkar, J. Ferdous, S.Z. Uddin and A.Z. Islam, "Temporal dynamics of land use/land cover change and its prediction using CA-ANN model for southwestern coastal Bangladesh," *Environmental Monitoring and Assessment*, vol. 189, 2017.
- [33] A.M. El-Tantawi, A. Bao, C. Chang and Y. Liu, "Monitoring and predicting land use/cover changes in the Aksu-Tarim River Basin, Xinjiang-China (1990–2030)," *Environmental Monitoring and Assessment*, vol. 191, 2019.



Tanja Trkulja, University of Banja Luka, tanja.trkulja@aggf.unibl.org
Ljiljana Došenović, University of Banja Luka, ljiljana.dosenovic@sf.unibl.org
Nataša Rodić, University of Banja Luka, natasa_rodic@yahoo.com

IMPROVEMENT OF THE URBAN GREEN MATRIX THROUGH URBAN REGULATION AND ARRANGEMENT OF UNDEVELOPED SPACES - CASE STUDY OF LAUSH SETTLEMENT IN BANJALUKA

Abstract

This paper aims to examine the state of undeveloped spaces in urban areas. The first part of the paper focuses on the state of the urban landscape's undeveloped spaces. To recognize their character and quality, the Narrative Spatial Analytics (NSA) method was proposed. It integrates three design research techniques which enable landscape designers to expand the scope of their research practice. The second part of the paper discusses a case study of neglected green space in the Laush settlement in Banjaluka, which could be incorporated into the Banjaluka green matrix. The phases of the solution concept for the arrangement of a new park and the elaboration details were analyzed, which completed the process of improving the Banjaluka green matrix.

Keywords: undeveloped city spaces, urban landscape, Narrative Spatial Analytics, urban design

UNAPREĐENJE ZELENE MATRICE GRADA PUTEM URBANE REGULACIJE I UREĐENJA NEIZGRAĐENIH PROSTORA - STUDIJA SLUČAJA NASELJA LAUŠ U BANJALUCI

Сажетак

Циљ овог рада је истраживање стања неизграђених простора у урбаним подручјима. У првом дијелу рада фокус је на стању неизграђених простора урбаног пејзажа. Да би се препознао карактер и квалитет неизграђеног простора предложена је метода Наративна просторна аналитика. Она интегрише три технике истраживања дизајна, које омогућавају дизајнерима пејзажа да прошире обим своје истраживачке праксе. У другом дијелу рада разматра се студија случаја запуштеног зеленог простора на подручју бањалучког насеља Лауш, које би се могло инкорпорирати у бањалучку зелену матрицу. Анализиране су фазе концептуализације рјешења за уређење новог парка и детаљи разраде, чиме је заокружен процес унапређења зелене матрице Бањалучке.

Кључне ријечи: неизграђени простори града, урбани пејзаж, наративна просторна аналитика, урбани дизајн

1. INTRODUCTION

Today's development and sustainability of cities are characterized by increasing construction. Characteristic of the entire world nowadays, intense urbanization has influenced the transformation of cities and changes in the quality of the environment, resulting in the degradation of the environment and life in cities. It has created extremely dehumanized urban systems, for people significantly move away from their primordial life space – nature [1].

The quality of city life can be significantly improved by appropriate changes in the way of using and arranging undeveloped urban spaces. These spaces include parks, green squares, coastal areas, protection complexes, and many other objects of landscape architecture, all of which have a social, ecological and aesthetic function. Parks provide opportunities for playing, recreation, social interaction, and personal and spiritual growth. They strengthen the sense of community and place of belonging [2]. Also, it appears that city parks are associated with improved physical and mental health, lower body mass index (BMI), reduced stress and anxiety, reduced disease, and even increased longevity [3-6]. People are said to have a predisposition to positively react to natural contents and environmental characteristics such as vegetation and water. Therefore, they consider urban environments much more stressful and less suitable for recovery from stress. The notion of the restorative power of contact with nature is widely supported and helps to explain people's tendency to be in the natural environment [7].

The value of urban greenery in shaping the city's image has been known for a long time. Parks, gardens and tree-lined avenues are valuable structural elements of urban form. The visual contribution of the green landscape is of high importance. Even a very limited number of landscape architecture objects significantly alleviates the environmental shortcomings of the completely built environment. Therefore, the green components of urban open spaces are key elements of urban design and planning. They significantly contribute to the cities' recognition, advantages and diversity, which further improves their competitiveness at regional and global levels and enables better development [8].

In light of this setting are the facts that „the floor area ratio must be analyzed carefully to reduce the negative effects in urban areas, and the introduction of nature into the urban environment, landscaping, parks and tree lines cannot be only a matter of artistic beautification of the city, but the task of arranging the living environment, whose 'technicality' and excessive construction can be dangerous for spiritual and mental health“ [9]. Therefore, the development of cities needs to be based on new humane principles of the planned building, in which people will be more in touch with nature.

This paper discusses the research process of planning and arranging undeveloped spaces in the urban area of Banjaluca. With efficient landscaping, spaces that are between previous use and still undecided new development can improve the green matrix system and contribute to preserving the identity of Banjaluca as a landscape city. Finally, the identity of the city should be respected. This city was formed thanks to its natural and cultural heritage. Banjaluca has been creating its recognizable identity for centuries. Therefore, this research intends to point out the scope of transformations of landscape structures in the context of the development flows of the city's urban matrix. As functional-ambient city units, green ecosystems with natural biological processes are areas of unique characteristics and elements of cultural and historical heritage. Their spatial form, manner and intensity of use in the city indicate how specific they are.

To achieve sustainable development of the green system in a city, which can satisfy ecological, social, economic and many other functions in various spheres of life, it is necessary to respect the needs of today's inhabitants, but also of future generations that will inherit the city and continue planning new development flows. Therefore, the transformation of urban spaces aims to meet these changing needs of their users in the dynamic life characteristic of the 21st century. The connection between society and space is the key cause-effect relationship that requires flexibility and transformability of space, but also its sustainability and resilience [8]. There is no doubt that the sustainable use and arrangement of space affect the city's development. Space is a public good, as well as a natural resource, so it should be used in a controlled way. In the end, there should be harmony between the built and natural environment.

The influential factors, which determined the new morphological phases of the spatial context of the urban greenery in Banjaluca, were analyzed in light of these changes. The research points to the state of the existing green spaces of the city, the possibilities of interpolation of new ones, as well as the tendencies of renewal and preservation of such vulnerable urban structures.

2. OBJECTIVE AND METHODS OF PAPER

This paper aims to point out the possibility of improving the quality of the environment and living conditions in the city by developing public green spaces. Appropriate changes in the way of using, designing and arranging green spaces contribute to this. One of the goals of sustainable urban development should be green matrix improvement. Accordingly, the intention is to point out the degree of transformation of green spaces in the context of the process of urban planning and development in Banjaluca.

Several methodological procedures focused on specific phases have been applied in this paper. The methodological apparatus of Narrative Spatial Analytics (NSA) is explained in the theoretical part of the paper. To bring new insights into the theory and practice of landscape architecture, the theoretical basis on which this methodological apparatus relies is specified. This part of the research is based on the method of critical content analysis by studying the available literature. A new method of designing research has been proposed. This was done through a set of narrative techniques, which originate in the field of architecture and all together form a research and design process that could provide a more comprehensive approach to landscape analysis. The scientific analysis results are presented and synthesized with valid arguments.

The applied part of this paper elaborates on the context analysis. Also, it gives a general overview of the green matrix system in Banjaluca, its development flows, spatial organization and structure. The 1975 Urban Plan of Banjaluca and the Draft of the 2020-2040 Urban Plan of Banjaluca served as the basic sources of data in determining the general setting of urban patterns of development and distribution of urban green spaces and landscape. Subsequently, the focus of the analysis was on the Banjaluca settlement of Laush. The results of the theoretical part of the research were applied to a specific case study - the conceptual urban solution of the new park in Laush. Field research and processing of collected data are determined through methods of structural, functional and causal analysis of relevant data from professional and scientific literature, including appropriate planning and program documentation. Field research using the in-situ method enabled space mapping. The phases of concept forming and the details of the elaboration of the urban solution were analyzed, which completed the entire process of designing a new park in Banjaluca. This way, it is possible to improve the existing urban patterns of development and distribution of green spaces in the process of urban planning.

3. THEORETICAL SETTINGS – NARRATIVE SPATIAL ANALYTICS

This part of the research aims to explain the used methodological apparatus of Narrative Spatial Analytics (NSA). The term Narrative Spatial Analytics (NSA) was defined by Pavle Stamenović and Đorđe Bulajić in their paper titled „Narrative Spatial Analytics (NSA) in urban landscape research and design“ [10]. Namely, the term represents a methodology designed through the joint work of master students of architecture in the joint curriculum between the elective course of Architecture of Territory (the Faculty of Architecture, University of Belgrade) and the elective studio of Green Spaces of the Urban Landscape (Faculty of Architecture, Civil Engineering and Geodesy, University of Banja Luka) during the winter semester of the 2019/2020 academic year. The focus of the semester was on observing the different spatial scales of the urban fabric of Banjaluca and its wider, peripheral territories, to connect the urban territory with the surrounding natural landscape. Taken as a whole, landscapes and the city's hinterlands as peripheral territories represent a significant and necessary spatial potential of the city. Therefore, the course raised the question of re-examining the importance, function and morphology of peripheral territories in the contemporary context of the city.

The NSA methodological apparatus proposes procedures derived from narrative planning theory [11, 12] and landscape design research [13] to bring new insights into the theory and practice of landscape architecture. These concepts are applied to landscape architecture to propose a new research-design method regarding the notion of 'scale' perceiving the landscape as a scale-continuum [10].

Landscape design research refers to the interpretation that landscape design is a means of acquiring knowledge of spatial composition via architectonic plan analysis [13]. Furthermore, this paper is a continuation of the contemporary narrative planning theory and the notion of narrative, which has a growing impact on urban planning and studies. As Lieven Ameel emphasizes: „The interest in urban narratives goes hand in hand with an increasing awareness that urban planning could (and in many countries legally should) take into account experiential, 'subjective' place-based information, shared in the stories people and communities tell of their place in the world“ [11]. Narrative planning theory

focuses on individual storytelling and, following Henri Lefebvre's interpretation, "it is implicitly founded on the thought that space is relative and intersubjective" [11]. This explains the idea that places are defined by the multitude of individual impressions, interests, and experiences, which are influenced by interpretations. As James Throgmorton suggests: „planning can be interpreted as a form of persuasive and constitutive storytelling about the future“ [12].

Stamenović and Bulajić [10] propose a set of narrative techniques (see Table 1), which originate in architecture and together form a research and design process which could provide a more holistic approach to landscape analysis. Instead of applying a conventional zoning methodology, the suggested one enables and unlocks the inherent physical layers of a given territory on a much deeper level. The recommended techniques explore deeper into the elusive layers of the urban landscape, thus making the research better grounded. Instead of a wide-ranging zoning process, which is a common planning technique, this iterative method enables a research and design procedure that simultaneously examines both the overall territory and the specific small-scale location.

Table 1. Narrative Spatial Analytics (NSA) techniques [10]

Technique	Deliverable	Refers to	Scale of view	Outcomes
Analytical mapping	Diagrammatic map	Context	Zoom out	Structure: layering the territory
Narrative drawing	Drawing	Context / Concept	Zoom in	Content: experiencing the life of the place
Architectural montage	Image	Concept	Zoom in / Zoom out	Form: representing the atmosphere and the character of the landscape

Analytical mapping is carried out through graphic work that exclusively contains elements and layers of particular interest for the research question, which is reducing of the amount of information from the geographical map. The analytical mapping process is continually repeated during the research and results in a series of diagrammatic analytical drawings and maps that allow new landscape readings. To produce analytical drawings, the essential characteristics of what the researcher sees must first be scanned, filtered and selected in order to focus only on specific elements and include informal layers of territory related to the narrative capacity of the landscape [10].

Narrative drawing captures a moment in a series of events which define the continuous process of a particular spatial scenario. It seeks to unite all the peculiarities of the characteristic space pattern: all the irregularities, built and unbuilt layers, traces of use and signs of life. The procedure is performed according to previously established criteria that relate to circumstances (context), needs (users) and intentions (architects). The techniques used for a narrative drawing are reduced to the simplest operations used by spatial designers – a line tool. It can be considered as taking samples of a certain territory, especially a characteristic feature of the space, with montage as a complementary technique. Narrative drawing rarely shows a top view - a plan, because it is crucial that this drawing contains spatial attributes and characteristics of both quantitative (analytical) and qualitative (narrative) procedures during the design research process [10].

In the NSA methodology, architectural montage is used as a tool that provides information on the physical characteristics of space, atmosphere, and merging of physical context and proposed spatial intervention. It is often applied in architectural design and research, and is presented here in landscape architecture. „Working on images through the technique of montage means bringing them to life, capable of producing new and different meanings“ [14]. The architectural montage consists of two narrative layers: (1) the corpus, the base - photographic representation of the place, and (2) the intervention – the layer developed through a various number of techniques and built into the corpus of an image, representing the suggested spatial intervention. We can distinguish two types of NSA montage: (1) orthophoto montage created using the aerial satellite imagery provided by the GIS and (2) perspective view montage created using photographs obtained in situ during the survey [10].

The synthesis of all these data and new knowledge was made to structure the spatial design concept of the selected spatial framework and develop the concept of intervention for design transformation.

The results were evaluated throughout the whole creative process, from in-situ field research to design solutions and applications (Fig. 1).

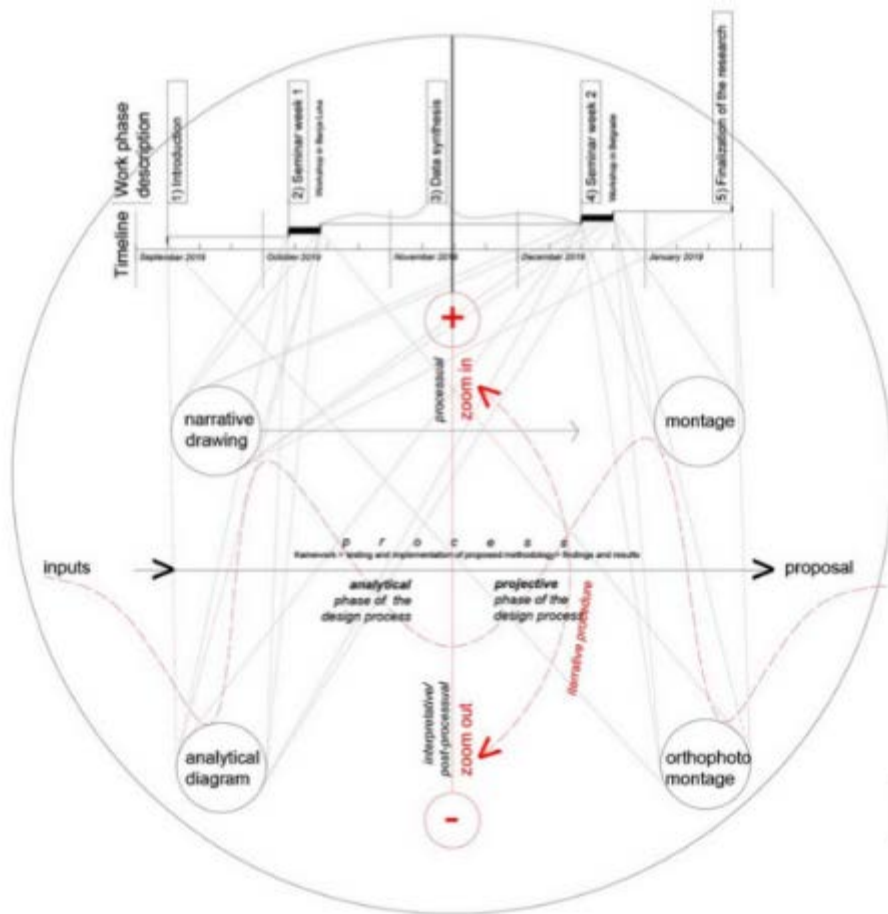

Figure 1. *Narrative Spatial Analytics (NSA) process diagram [10]*

4. CONTEXT ANALYSIS

4.1. CONTEXTUAL ISSUES

Banjaluka is the largest city in Republic of Srpska, and the second largest city in Bosnia and Herzegovina. According to the last census (2011), the urban settlement numbers 179,349 inhabitants, while the overall number of inhabitants in the city of Banjaluka is 227,603. The urban area covers an area of 17,900 ha, out of which 5,224 ha fall on the inner urban area of the city [15]. The green structure of the city is deeply woven into its urban matrix. Even though the urban landscape has transformed through its genesis, the green matrix has remained directly related to development trends, so that the 'green city' has become a synonym for Banjaluka [16]. The need to preserve and arrange the existing and plan new buildings of landscape architecture in connection with the further development of Banjaluka is evident. It is also a part of the strategy outlined in previous urban plans. Basic analyses of the 1975 Urban Plan of Banjaluka [17] indicate that the creation of optimal conditions for a healthy and pleasant life, the establishment of creative harmony of natural and created values and environmental protection were the starting point for defining basic planning determinants. The definition of the urban territory space came after a complex analysis of long-term economic and social development with the possibilities of physical transformations in the context of spatial distribution. Understandably, the projection of development is accompanied by all the undesirable processes of transition, urbanization and demographic growth. Therefore, it is necessary to take measures to ensure a sufficiently efficient green system as a tool that will mitigate the negative consequences and contribute to a sustainable and resilient city with its functions in protecting the quality of the environment.

Spatial and functional analysis of the facilities of the Banjaluka urban greenery system pointed out the relevant characteristics of the development so far. In the City Regulation Program [18], the author cites three (out of nine) guidelines dedicated to green spaces - two with natural features of

green structure and one with the role of landscape architecture in shaping the city's identity. It emphasizes the importance of urban greenery and the Vrbas coast as structural elements of urban concept and the organic connection of the city with the river. Also, it points out that development flows should change the direction of the longitudinal expansion of the city. The explanation of integrating the green spaces in the immediate vicinity of the river as well as those in other parts of the city is clear.

The greenery system in the 1975 Urban Plan of Banjaluka [17] includes forest complexes and orchards in the area, parks, and tree lines in the inner urban area. At the same time, the term park includes integrated green spaces next to buildings or complexes, which do not have adequate equipment in the form of urban furniture and infrastructure which encourages their use. The identity of the landscape character of the city was not missing in this document either. The theme of integrated landscape architecture is set as a unique greenery system, which in the spatial organization of urban territory is a connecting element of the composition of urban structures and an important environmental factor, pointing to the development processes that follow. The concept of green structure is cited as an instrument for shaping the urban matrix, that is, the spatial level of the green structure and its continuity are considered important factors in city planning.

The focus of the concept of the 1975 Urban Plan of Banjaluka [17] is the introduction of forest massifs in the urban fabric, green corridors of primary roads, and watercourses of the Vrbas and Vrbanja rivers. Greenery from the southern and southwestern forests is introduced through the longitudinal corridor of the highway, western and eastern transit continuously through the entire urban area, all the way to Zalužani, where it drowns in the northern protection zone that introduces the Trappist forest, thus permeating the northwestern industrial zone. The Trappist forest, which touches the inner urban area in the form of wedges on the east side, is interpolated into the urban structure via transverse roads. The penetration of the Trappist forest into the urban fabric in the western direction is especially significant through the central transverse move of the future expansion of the city over the large meander of the Vrbas river. The plan envisages arranging free open spaces in the urban area by greening residential, work and recreation zones through a network of urban greenery, forest complexes and agricultural landscape into a single system of greenery (Fig. 2).



Figure 2. The position of the Laush settlement in relation to the more significant existing green spaces in Banjaluka

Observing the planned patterns of development and distribution of green spaces, the intention is to establish a unique system throughout the territory, which should meet the criteria of even, continuous and homogeneous distribution of green spaces. Comparing the then planned green spaces with the current situation, it can be stated that a unique greenery system has not been established in the entire urban area, but only in its narrowest part. Apart from the incoherence of the green corridors, the problem of not arranging the coasts of the Vrbas, Vrbanja and Suturlija rivers is also acute. Although it represents a natural whole, the move of the Vrbas through Banjaluka is marked by differences in individual sections and sectors. A similar problem is an interference in the construction of green spaces in the central parts of the city. Undeveloped free spaces, which could be integrated into the greenery system, are mostly designed with a very low degree of greenery. The newly created objects of urban greenery do not correspond to the category to which they belonged in terms of dimensions,

function and spatial form. They often do not represent parts of an organized greenery system but are formed without a planning concept, so their ecological contribution to the protection and improvement of the environment is minimal. Parks, with their dimensions and contents, still do not provide equal access to their users. According to the Accessible Natural Green Space standard (ANGSt), parks should be arranged in such a way that no resident lives more than 300 m (5-minute walking distance) away from the nearest accessible public green space of at least 2 ha in size. Also, at least one park of at least 20 ha in size should be accessible within 2 km from home.

Certain discrepancies have been noticed after seeing into the data on the analysis of the state of green spaces in the inner urban area of Banjaluka (Tab. 2), which are following valid classifications and indicators. ANGSt was used for planning settings at the level of settlements and statistical circles, in relation to the residential buildings that represented the spatial distribution of residents in a most accurate way. Table 2 shows the areas of green spaces in more detail. The data from 1975 is reliable because the Plan is the outcome of very detailed research on all parameters. When it comes to data from 1991, the high number of lined trees remains questionable (9,462) because, in the period from 1991 to 2019, there was no reduction in the length of tree-lined streets. On the contrary, their number increased. If we compare the amount of greenery between buildings in 2008 and 2019, we can notice a significant decrease. This decrease occurred due to turning some green spaces around residential complexes into construction land [19]. In that context, it should be noted that there was no greenery in the new residential zones at all. There were no park formations either, which is a big problem for the quality of the city life. Even though Banjaluka has excellent bio-ecological and spatial conditions for the formation of a quality green matrix, the analysis of the current situation shows that the areas of parks, squares and other public green spaces haven't significantly changed throughout the observed period, despite the fact that the city development and population have a growing tendency. There is also an evident spatial disproportion of the existence and quality of content in parks and the lack of space for their formation, which is also worrying. The ratio of public green spaces and the number of inhabitants as a standard parameter is 10.3 m² per inhabitant, which is lower than the European norm, according to which 12-15 m² per inhabitant is recommended. In Banja Luka the total area of green spaces per inhabitant is 28.9 m² per inhabitant [20].

Table 2. Analysis of the state of green spaces of inner urban area of Banjaluka [20]

Elements of greenery	Unit of measure	1975.		1991.		2008.		2019.	
		Area (m ²)	m ² /st.	Area (m ²)	m ² /st.	Area (m ²)	m ² /st.	Area (m ²)	m ² /st.
Parks, squares, other public green areas	m ²	19,629	2,0	191,320	1,27	233,979	1,39	241,781	1,53
Greenery between buildings	m ²	96,439	0,98	578,809	3,87	900,000	4,83	495,938	3,14
Tree lines	kom.	5,667	-	9,462	-	8,000	-	7,579	-
Cemeteries	m ²	305,000	3,11	342,825	2,29	571,500	3,07	766,486	4,85
Population		98,095		149,526		186,312		157,926	

In the current period, regulatory plans of individual city units were made. The Draft of 2020-2040 Urban Plan of the City of Banjaluka [20] was also made after the adoption of the Spatial Plan of the Republic of Srpska [21]. Urbanization and all the changes (demographic, sociological, cultural, ethnic and other structures) in the Republic of Srpska, have significantly affected the changes in the greenery system. The permanent population growth has led to an increased need for housing, so the need for construction land is growing. The city penetrates natural landscapes, protected objects of landscape architecture and park forests, creating a peri-urban zone with morphological features without clear meaning. Green spaces are spatial resources for new construction, and this major problem needs to be solved.

4.2. CASE STUDY – URBAN PLANNING CONTEXT AND DEVELOPMENT OF LAUSH SETTLEMENT

The Laush settlement is located in the western part of Banjaluka (Fig. 2). According to a theory, the origin of its name dates back to the period of the Greeks and Romans. It is derived from the word *laus*, which means *tump/hill*. According to another theory, the settlement was named after the Laush stone that was extracted from the quarry on the hill. However, the most probable of all theories is one according to which the name of the settlement comes from the Hungarian medieval nobleman

Ljudevit Lajosh, who once built a church on Pobrđe. Later, 'Lajosh' was formed into 'Laush', and the river that flows through the settlement was named after the word *church* – the Crkvena [22].

The settlement is distinguished by a dense population, unplanned construction, and poor inaccessible infrastructure. There are two local communities in Laush: Laush 1 and Laush 2. The 5-kilometer-long Crkvena stream flows through Laush, running northwest-southeast. According to the data of seismic maps from the Book of Rules on Technical Norms for Construction of High-Rise Buildings in Seismic Regions, the subject area is in the zone of maximum expected earthquake intensity 90 MSK, seismic coefficient $K_s = 0.100$ [23].

According to the 1991 census in the Socialist Federal Republic of Yugoslavia, there were 10,910 inhabitants in Laush. According to unofficial data, Laush numbers as many as 30,000 people today. This number is the approximate number of inhabitants in Trebinje, for example. The first industrial zone in Banjaluka was in Laush, so this settlement used to be the city center. Namely, after the annexation of Bosnia and Herzegovina in 1878, the Austro-Hungarian monarchy opened a brown coal mine at the foot of Laush Hill (in 1980), and later a narrow-gauge railway to the railway station in Banjaluka. This way, Laush coal was transported to Croatia, Slovenia, and other parts of Austria-Hungary. The main street that passes through the settlement, Rudarska Street, which was later renamed Karadjordjeva Street, is also named after the mine. Since the mine ran out of ore, it stopped working in 1937 [22]. The 1900 map shows the Coal Trade Association (*Kohlen-Berufsgenossenschaft*) (Fig. 3).

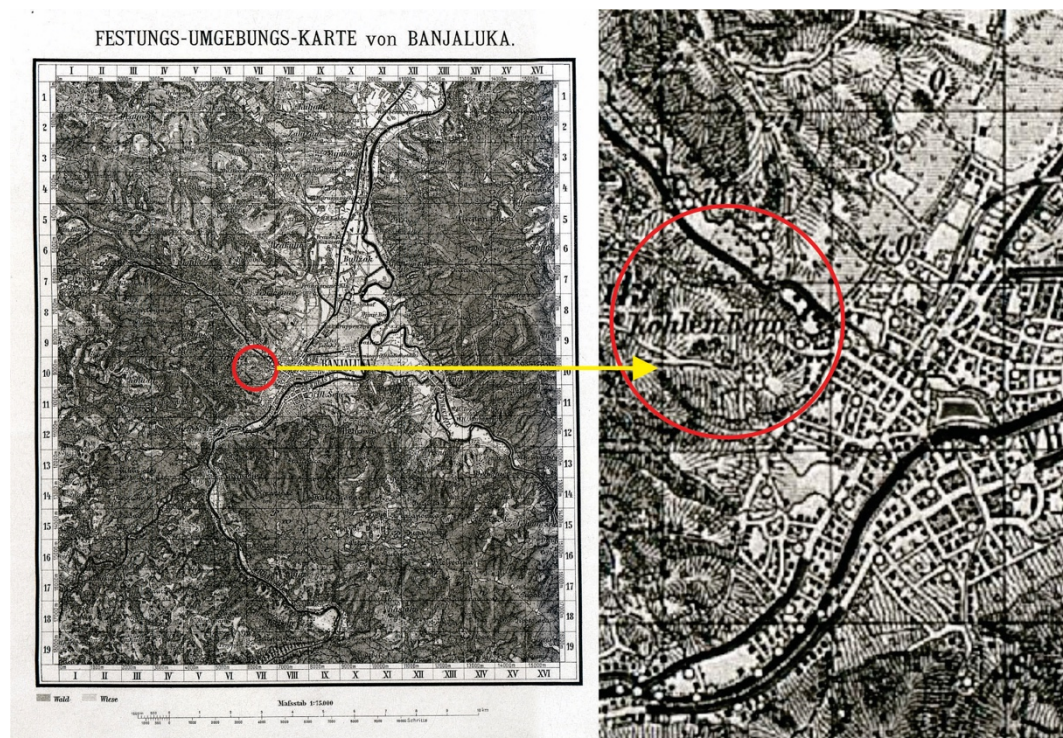

Figure 3. *Festungs - Umgebungs - Karte von Banjaluka, 1900.* (Source: Authors according to [24: 50], the map is taken from Map department of Austrian National Library)

Laush was the location of the first thermal power plant ever built in Banjaluka. The Laush thermal power plant started operating in 1923. and was then one of the higher-capacity thermal power plants in Bosnia and Herzegovina. Besides the Trappist hydroelectric power plant, this thermal power plant supplied Banjaluka with electricity in the following 30 years. The construction of hydroelectric power plants on the Vrbas and the transmission line to Zagreb in 1957 finally solved the electricity supply in Banjaluka, so the thermal power plant ceased to operate that year [22].

The Google Earth image clearly shows the dense construction along Karadjordjeva Street, which connects the settlement to the city center. The buildings are mainly single-family houses, built without a plan and on sloping terrain. The green structure behind the built structures is also dominant (Fig. 4).



Figure 4. *Built area of the Laush settlement*

4.3. CONCEPTUAL DESIGN OF URBAN PARK

The subject area is located in the western part of the city of Banjaluka, about 3 km from its center. It is in the Laush settlement, between Karadjordjeva Street, Užička Street, St. Nikola Street and Pavlovac Street. The predominant purpose of the subject space is single-family housing. Near the location, there is also the Čenić cemetery, the Saint Sava elementary school and a commercial building. The backbone of the settlement is the Karadjordjeva Street. Local roads are "branching" from it, which are very steep, narrow and inadequately equipped. Single-family housing is concentrated around them, characterized by unplanned/illegal construction (without building permits). All that is the consequence of the slow resolution of housing needs for an increasing number of inhabitants (Fig. 5).



Figure 5. *Location of the subject area*

The green spaces in the subject area are mostly private yards. The most important landscaped green space is the schoolyard of the Saint Sava elementary school. Within the school complex, a yard with a sports field and green areas has been formed. There are no other contents related to sports and recreation. The recreational function of greenery, through the attitude towards housing, indicates the need to use green spaces in the process of planning the functional-spatial organization of physical structures of the residential area. When designing the greenery of residential zones, it is necessary to first see how the position of the residential zone is related to the structure of the settlement. Also, the evaluation of existing green components such as groups of trees, massifs or individual trees should be taken into account. It is necessary to plan a block park in all major settlements of the city. Williams [25] argues that city dwellers participate in most of their daily leisure activities in the urban area in which they live - at or near the home. Therefore, according to the Laush 3 Regulatory Plan [23], one of the basic goals related to the arrangement of green spaces is forming a local park area of at least 2 hectares in size (according to ANGSt [19]), in a free area that exists as a meadow owned

by the City of Banjaluca. Within the park, it is necessary to organize recreational facilities and enrich the living environment of the inhabitants. This is the backbone of the design concept.

The concept design was created through the presented NSA methodology. Trying to connect the peripheral territories to the urban matrix of Banjaluca, the theme of the city landscape and green hinterland stood out as a significant spatial potential of the city. Its significance, function and morphology in the contemporary context of the city were re-examined through the research process. The methodology enabled a research and design process that simultaneously explored the entire area and a specific small area. Since the research of landscape design relied on the interpretation that „landscape design is a means of acquiring knowledge about spatial composition via architectonic plan analysis“ [13], analytical mapping was conducted through analysis on a geodetic map. The scale is zoom-out. The result of the analytical mapping procedure is a series of diagrammatic analytical drawings and maps which enabled new context readings (Fig. 6). Analytical maps, above all, show the layering of the selected space and housing as the dominant existential space.



Figure 6. Analytical maps: buildings, traffic and greenery

Furthermore, the paper is connected to the contemporary narrative planning theory which includes experiential, "subjective" ground-based information, during in-situ research [11]. Places are defined by a multitude of individual impressions and experiences based on which were created sketches of key places within the subject context (Fig. 7). The scale is zoom-in. The authors concentrated on experiencing the life of the place through the keyspace functions.



Figure 7. Spirit of the place, the Laush settlement

Sketches of key places of the subject context are the first step in defining a narrative drawing. Namely, the narrative drawing records a series of events of a certain spatial scenario and seeks to unite all the peculiarities of the characteristic space pattern. The scale is zoom-in/zoom-out. Samples of context, its features and spatial attributes are taken, using architectural montage as a complementary technique. Architectural montage revitalizes the space, giving it new meanings. The narrative drawing represents the atmosphere and the character of the landscape. Dominant family houses surround the site in the north and south. They are arranged along the high slope road. The cemetery is west of the site, which is bare and neglected. The road, cemetery and family houses are presented in the narrative drawing. Its focus is „empty space“, which is the abandoned subject location chosen for the park design (Fig. 8).



Figure 8. *Narrative drawing through architectural montage*

The synthesis of all these data and new knowledge influenced the definition of the spatial design concept - the "merging" of the dominant forest context through the subject location. Such dense trees are a response to a pronounced landslide in order to biologically reinforce the soil. The problem of dense unplanned construction is opposed by green open space with a multitude of public facilities for the purpose of better social cohesion. The Laush Park is formed spontaneously in the spirit of the settlement itself. Spontaneity is reflected in the way we use the various contents of the space: sports fields, open amphitheater, lake, recreation trails, cafe-restaurant and many micro ambiances which improve urban life. In the area of 43,000 m² (4.3 hectares), three zones stand out: 1) cafe-restaurant /vacation/walk, 2) lake with open amphitheater and 3) sports fields (Fig. 9).



Figure 9. *Master plan with spatial zones*

The first zone is located at the highest point of the park and occupies the widest zone below the zone intended for the cemetery infrastructure expansion. The leveling of the terrain is solved by a natural amphitheater for sitting and resting. A green-roofed cafe-restaurant is built in the field, in front of which the main pedestrian promenade for walking and passive recreation was designed (Fig. 10).



Figure 10. *First zone: cafe-restaurant, rest zone, recreation trails*

The second zone is connected to the first zone and represents the central part of the park with an artificial lake and an open amphitheater. The shore of the lake is natural with aquatic plants and natural materials. An open amphitheater has been designed on the north side of the lake. It is also a wooden structure for resting, sitting, lying down and gathering. The whole area is enriched with greenery: a variety of trees and shrubs (Fig. 11).



Figure 11. *Second zone: lake, open amphitheater*

The third zone is the closest to Karadjordjeva Street. Since it is the closest to the elementary school, sports fields for active recreation have been designed. Sports fields are set at different altitude levels, leveling the plateau of the sloping terrain. Height levels are mastered by the stands. A screen for video projections is planned on the east side of the middle sports field (Fig. 12). The goal is to provide all the settlement residents with adequate space for rest and recreation, sports and children's games, in order to enable better social contacts and relations among the residents. Also, Dadvand et al. [26] prove that a larger green environment around home and school is associated with the improved cognitive development of school children: better progress in working memory and better attention. The whole area is richly greened in order to biologically reinforce the land and ecological and aesthetic improvement of the space.



Figure 12. *Third zone: sports fields*

It is distinctive that this student project did not remain 'locked in a drawer' as usually is the case. On the contrary, it was presented to the Mayor of Banjaluka by the Association of Citizens called 'Zeleni Lauš'. The initiative for the construction of this park was adopted at the session of the City Assembly in October 2021. The re-drafting of the Laush 3 Regulatory Plan is currently underway, and the initiative for the construction of a multifunctional park in Laush will be taken into account.

5. CONCLUSION

Undeveloped urban landscapes have a natural potential more important than the potential of being considered as building plots intended for urbanization by built structures. The increasing population density in city centers and their simultaneous expansion have become a threat to the existence of open and green spaces. In order to improve the condition of green spaces and achieve satisfactory efficiency of endangered landscape elements, this paper examines their importance for the city. There are opportunities to improve the quality of green infrastructure in the built-up urban matrix. One of them is the arrangement of neglected green spaces owned by the City of Banjaluka. Their regeneration is an acceptable method in the function of increasing comfort in the inner urban area of Banjaluka and therefore provides the opportunity to restore the identity of the green city.

The research methodology used in this paper is based on simultaneous design procedures on opposite scales, starting from the overall importance of the perception of the whole and its parts. The special focus is not on reading the concept of (urban) landscape, but on the techniques by which space is analyzed while clarifying the concept of design and defining the meaning of the place. The proposed method of Narrative Spatial Analytics (NSA) includes three research design techniques that allow landscape designers to expand their research practice: 1) Analytical mapping, 2) Narrative drawing, and 3) Architectural montage. The result of this research is the concept of spatial design which takes into account both quantitative (analytical) and qualitative (narrative) procedures during the research process.

In applied research, the emphasis is on the protection and improvement of the existing biodiversity and the quality of human life. Research has shown that the restoration of neglected green spaces and their integration into the environment also provides space users with an appropriate level of safety and comfort. The project sought to create a stimulating space, which affects the development of localities and increases land and real estate value. Protecting existing biodiversity and interpolating the new green structure provides safe, attractive, and economical places for work and active and passive recreation. Upgrading the ecological and aesthetic quality of the environment undoubtedly affects the significant improvement of the quality of life of people who live and work in this area.

ACKNOWLEDGEMENT

The conceptual urban design of the new park in Laush was created during the winter semester of the 2019/2020 academic year within the teaching process on elective studio Green Spaces of the Urban Landscape, University of Banja Luka, Faculty of Architecture, Civil Engineering and Geodesy. Authors of the project are Nataša Rodić, Jovana Milovanović and Biljana Petrović. Project mentors are Full Prof. Ljiljana Došenović and Assoc. Prof. Tanja Trkulja.

LITERATURE

- [1] Lj. Došenović, T. Trkulja, *Rekreativna funkcija šumskih kompleksa Banjaluke kao element prostornog i urbanističkog planiranja*. Banja Luka: Univerzitet u Banjoj Luci, Šumarski fakultet, 2019.
- [2] M. Townsend, R. Weerasuriya, *Beyond Blue to Green: The benefits of contact with nature for mental health and well-being*. Melbourne: Beyond Blue Limited, 2010.
- [3] P. Y. Tan, „Perspectives on greening of cities through an ecological lens,” in *Greening Cities: forms and functions*, 2017, pp. 15-39.
- [4] G. T. Svendsen, „From a Brown to a Green Economy: How Should Green Industries Be Promoted?“, *Environmental Practice*, 15(1), pp. 72–78, 2013.
- [5] H. Frumkin, M. E. Eysenbach, *How cities use parks to improve public health*. American Planning Association: City Parks Forum Briefing Papers, 2003.
- [6] T. Takano, K. Nakamura, M. Watanabe, „Urban residential environments and senior citizens' longevity in megacity areas: the importance of walkable green spaces,” *Journal of Epidemiol Community Health*, 56(12), pp. 913-918, 2002.
- [7] J. M. Jenkins, J. J. Pigram, *Encyclopedia of Leisure and Outdoor Recreation*. London: Routledge, 2003.

- [8] T. Trkulja, Lj. Došenović, Sistem urbanog zelenila u procesu razvoja održivog i otpornog grada. Banja Luka: Univerzitet u Banjoj Luci: Arhitektonsko-građevinsko-geodetski fakultet, 2020.
- [9] R. Radović, Forma grada – osnova, teorija i praksa. Beograd: Orion art, 2003.
- [10] P. Stamenović, Đ. Bulajić (2021). „Narrative spatial analytics (NSA) in urban landscape research and design,“ *Urban design International* [On-line]. Available: https://link.springer.com/epdf/10.1057/s41289-020-00148-0?sharing_token=v9GZvtc0OUKShmrEUSx2V1xOt48VBPO10Uv7D6sAgHtWOjvyOziGE-7hlj0I-wUzSTX98qP-JjBEYQdFMdBuLZAlxWd7TKNktVHME_ev4cRG7ClSc9qXn2TaT6YZ8GSWdB17SINkQBcmmbMzNG4PTOYqHwsskIvypujOTQSDh98%3D [Feb. 1, 2022].
- [11] L. Ameen, *The Narrative Turn in Urban Planning: Plotting the Helsinki Waterfront*. London and New York: Routledge, 2020.
- [12] J. A. Throgmorton, „Planning as Persuasive Storytelling in the Context of the Network Society“, in *ACS P-AESOP Third Joint Congress*, 2003. <https://doi.org/10.17077/h5mm-k1r6>.
- [13] S. Nijhuis, „Applications of GIS in Landscape Design Research,“ *Research in Urbanism Series*, 4 (1), pp. 43–56, 2016.
- [14] L. Galofaro, „On the Idea of Montage as Form of Architecture Production,“ *Proceedings 2017*, 870, pp. 1–9, 2017.
- [15] Prostorni plan grada Banja Luka 2014-2030. godine, Banja Luka: „Projekt“ a.d. Banja Luka i Institut za građevinarstvo „IG“ d.o.o. Banja Luka, 2014.
- [16] T. Trkulja, „Urbani pejzaž Banjaluke – tradicionalni i savremeni odnos prema prirodnoj i građenoj sredini,“ in *Zbornik radova Međunarodnog naučno-stručnog skupa Arhitektura i urbanizam, građevinarstvo, geodezija - juče, danas, sutra*, 2011, pp. 403-410.
- [17] Banjaluka – urbanistički plan, sinteza, Banjaluka, Urbanistički zavod Banjaluka, 1975.
- [18] A. Kirjakov, *Generalni urbanistički plan Banjaluke*. Sarajevo: Urbanistički zavod glavne uprave za komunalne poslove Narodne Republike Bosne i Hercegovine, 1952.
- [19] *Natural England*. (2010). ‘Nature Nearby’ - Accessible Natural Greenspace Guidance. [On-line]. Available: http://www.ukmaburbanforum.co.uk/documents/other/nature_nearby.pdf [March 21, 2022].
- [20] Urbanistički plan grada Banjaluke 2020-2040. - nacrt, Banja Luka, Urbis centar, 2022.
- [21] Prostorni plan Republike Srpske do 2015. godine, Banja Luka, Urbanistički zavod Republike Srpske a.d. Banja Luka, 2008.
- [22] Mondo, (2017). „Ovo možda niste znali o Laušu ... (foto, video),“ [On-line]. Available: <https://mondo.ba/Info/Drustvo/a751139/Laus-zanimljive-cinjenice.html> [Dec. 1, 2003].
- [23] Regulacioni plan "Lauš 3", Banjaluka, Urbanistički zavod Republike Srpske a.d. Banjaluka, 2006.
- [24] M. Malinović, *A monograph: The architecture in Banja Luka during the Austro-Hungarian rule in Bosnia and Herzegovina between 1878 and 1918*. Banja Luka: Arhitektonsko-građevinski fakultet, 2012.
- [25] S. Williams, *Recreation in the Urban Environment*. London: Routledge, 1995.
- [26] P. Dadvand, M. Nieuwenhuijsen, M. Esnaola, J. Forn, X. Basagaña, *Green spaces and cognitive development in primary schoolchildren*. Worcester, MA: Clark University, 2015.



Malina Čvoro, University of Banja Luka, malina.cvoro@aggf.unibl.org
Juan Luis Rivas Navarro, Universidad de Granada, juanluisrivas@ugr.es
Igor Kuvač, University of Banja Luka, igor.kuvac@aggf.unibl.org

LINEAR LANDSCAPE. THE IDEA OF ACTIVATION OF THE OLD BANJA LUKA - ČELINAC ROAD AS A NARRATIVE ITINERARY.

Abstract

Cities worldwide reshape their urban infrastructure by taking care of healthier and more economical lifestyles. The idea is to reflect the role of urban design and architecture in promoting sustainable urban mobility in Banja Luka and reading of the territory that brings citizens closer to its suburban environment, beyond avoiding constant use of private cars. The study was conducted during the spring of 2021 with a group of students from the Faculty of Architecture. The result is an offer of scenarios for further development of the narrative itinerary in the linear territory between Banja Luka and Čelinac. The study offers prototype conditions that could be relevant in similar contexts and form part of an open discussion on possible approaches to the challenges inside and outside of Bosnia and Herzegovina.

Keywords: sustainable urban mobility, narrative territory, Banja Luka - Čelinac, B&H

ЛИНЕАРНИ ПЕЈЗАЖ. ИДЕЈА АКТИВИРАЊА СТАРОГ ПУТА БАЊА ЛУКА – ЧЕЛИНАЦ КАО НАРАТИВНОГ ИТИНЕРАРА

Сажетак

Многи градови широм свијета трансформишу урбану инфраструктуру тако што воде рачуна о здравијим и економичнијим начинима живота. Идеја чланка је да се размисли о улози урбаног дизајна и архитектуре у промовисању одрживе урбане мобилности у Бањој Луци и читању територије која приближава грађане њеном субурбаном окружењу, избјегавајући сталну употребу аутомобила. Студија је проведена током прољећа 2021. године са групом студената Архитектуре. Резултат је понуда сценарија за даљи развој наративног итинерара у линераној територији између Бање Луке и Челинца. Студија нуди прототипне услове који би могли бити релевантни у сличним контекстима и чинити дио отворене дискусије о могућим приступима изазовима унутар и изван Босне и Херцеговине.

Кључне ријечи: одржива урбана мобилност, наративна територија, Бања Лука - Челинац, БиХ

1. INTRODUCTION

1.1. NARRATIVE TERRITORY

The urban territory of Bosnia and Herzegovina (BiH) and the city of Banja Luka in particular, as an attractive capital of residence, employment and central functions, is not alien to contemporary urban dynamics. Despite its specific situations, urban history and spatial culture, it demonstrates specific local urban phenomena as patterns of behavior that have been studied in theory and in many other urban contexts. Thus, some shared spatial patterns, problems, threats or risks and also potentials or strategies may have been experienced as successful in many other geographical or cultural contexts and their current conformation in the territory. In this sense, the urban territory of Banja Luka is not unfamiliar to contemporary urban processes found in the European city and in other contexts. Those are metropolisation; urban sprawl -also erratic localization of functions- [1, 2]; increased traffic, with consequent over-representation of infrastructure or demand for sustainable mobility [3, 4, 5, 6]; loss of identity [7, 8, 9] in a context that is sometimes predatory towards "land resources", as well as the threat to biodiversity and serious deterioration of urban environment [10, 11].

As we will see in the case study of a suburban space, urbanization patterns correspond to the concept of "horizontal metropolis" developed by Viganò, Cavalieri and Barcelloni where borders, boundaries and flows blur [12]. This extended idea of urbanization suggests that the same is not only about expanding agglomeration areas or creating new ones, but also about incrementation of operational areas (agricultural land, resource extraction sites, forests, physical infrastructures, and logistic system), which lie today "in a condition of geographical interdependence" [13]. As Cavalieri says, "it is via this hyper-connected space where diffusion does not mean dispersion, that each fragment encounters its potential meaning (alongside to its nostalgic dimension), becoming part of an urban whole" [12].

Bernardo Secchi [14] was right in the eighties when he showed the difficulties of contemporary urbanism 'in search of a program'. In fact, urbanism should always concentrate on the experience of territorial transformations as a part of networks of themes revolving around different spaces and social groups. In order to grasp city behavior today and to understand its structure, it may be necessary to have the addition of something (new "material" or new link between what exists): "something capable of re-interpreting and re-inventing it, and by intervening on the gaps in between" [14].

The narrative and multiple nature of what is urban requires us to emphasize numerous mechanisms of observation that are capable of recording and collecting all those special 'objects' that we encounter directly. For this, it is needed to exercise an acute sensitivity -an almost childish curiosity- both towards events, entities and mainly towards the incidents. Furthermore, in the face of the global, administrative and economic tendencies, the natural history of the territory should be a main focus in order to deepen 'study of space' in more definite and timeless logics [15] (Figure 1).

In suburban areas such as in Banja Luka, a "self-organized" process of territorial development is governed by the market, rather than by the urban planning mechanisms, which, effectively, leads to fragmentary development, without integration with environment, in the outsourcing of the activities and the unprecedented combination of functions, or in the corporate and commercial language of the architecture [16]. This leads to urban growth forms of 'diffuse' configuration, conurbation systems or 'filaments' born in relation to a capillary and multidirectional road network, which guarantees a high connection between the different points of territory that increasingly works in an elongated way [16]. For this reason, proposing (linear) narrative systems, which understand the current hyper textual urban logic, but remain in contact to the ground, to its geography and its history, would serve, beyond the environmental paradigm, to provide the spatial and social cohesion that the urban territory seems to claim.

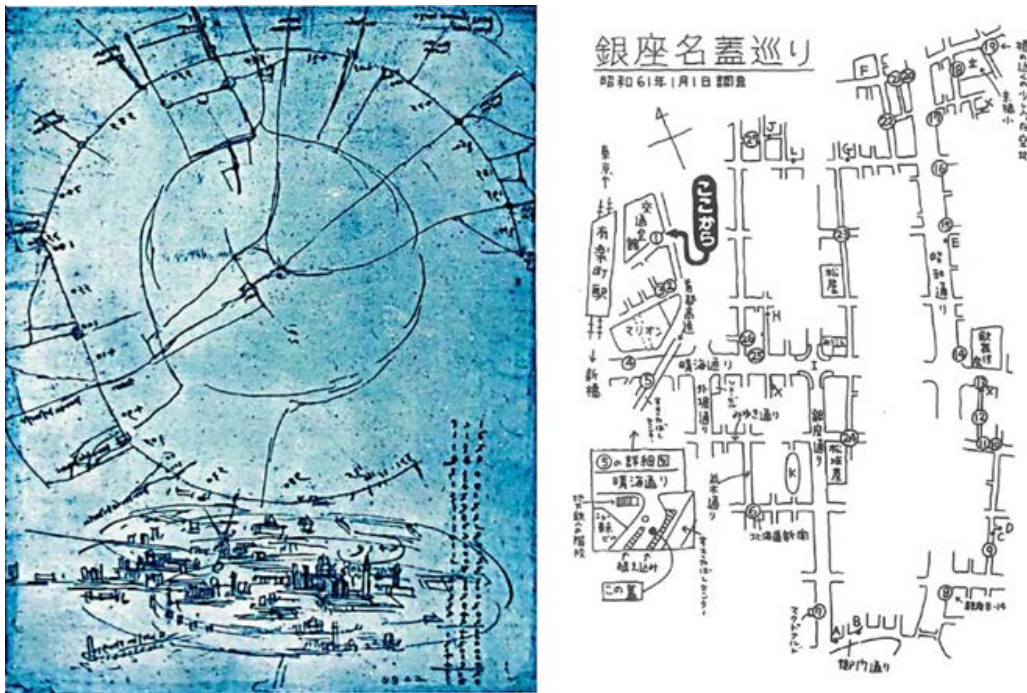

Figure 1. (left) Sketch study by Leonardo da Vinci for the decentralization of the city of Milan, 1497; (right) Street observation map, Ginza district.

1.2. LINEAR SECTION OF THE URBAN TERRITORY

"The men who for the first time traced a path between two places carried out one of the greatest human achievements. They must have often covered the distance between here and there and thereby linked them subjectively: places were objectively linked only insofar as they visibly *printed* the path on the surface of the earth; **the binding will become a configuration of things.**" [17].

In this text by George Simmel, taken from *The Individual and Freedom*, we find the process that we are trying to reflect, between the desire for an alternative and useful "link" between Banja Luka and Čelinac, from the will to the configuration, from teaching and social experience towards urban design. In the contemporary urban scenario that we have defined, this new link obviously transcends the urban scale to always be situated at a "contextual" level, where an important commitment of architecture with landscape is established by the usual ethnographic practices [18], as it was in this case walking or riding a bicycle.

This "looking outside" connects with the initial period that was proposed by André Corboz to understand the approach of urban theories to the problem of urbanization, which aimed to project "the city outside the existing city" [19, 20]. Exemplar references from this period would be the urban fabric of Barcelona projected from the walls of the historical city outward to incorporate the neighboring villages by *Cerdà* in 1859; the urban fabric projected along public transport lines in the *Soria y Mata's Linear City* from 1882; or the network of small towns that would combine the advantages of both rural and urban living proposed according to *Howard's Garden City* from 1902). "There are territories that demand a project. They often scream for one." [21] The Banja Luka – Čelinac cutting line behaves as a narrative element in the urban fabric, a compound phrase that is added to so many existing stories: "A project like a story is to admit time within it. Personal time in which will be devised, material time to be built, multiple times with which it will be understood and related to the previous substrata of the city as a continuous construction [22].

The project of the itinerary, of the street in the territory, is the (re)invention of a channel that conveys a certain urban history in a city or an area. Thus, certain streets or itineraries would bring together more transit desires or intentions than others, determining both their load or level of service, from a functional point of view, as well as the degree of "publicity" of the street, its scalar range [23]. The discontinuous city on which we produce new configurations cannot effectively be read as a unit, since it can never be understood as a whole [24]. This type of urban spaces makes more sense to conceive them in themselves as a space of relationships and in movement, rather than as a relationship between fixed elements [25]. In the same way, new centralities can be deployed that are

no longer in the center, but in belonging to a network, or new civic centers could be constituted at the intersections of the social network and the physical network of the territory [26, 27].

The recognition of a cutting line can both rescue a landscape connected to history and geography and become a functional transformer, inserted in the urban and suburban environment in a natural way. As a consequence of intensive informal urban fabric, Banja Luka has recently increased by the main roads in a few directions, mainly towards Prijedor (M4), Laktaši (M16) and Čelinac (M4). This kind of urbanization is characterized by the unplanned occupation of agricultural land and forests, lack of basic infrastructure, traffic communications, public spaces and facilities causing numerous communal problems, economic ineffectiveness and unsustainability. They grow following the ownership structure of the land, ability to access the plots, economic power of inhabitants and their actual needs (extensions, auxiliary facilities, etc.), traditional patterns of housing and family life, etc. Fragmented physical structure pervades the natural environment while they endanger each other. Those are the reasons we think the strategy of creating linear narrative landscapes with the objective of territory consolidation and solving one of the main problems -urban mobility- could be tested and implemented in the long section of territory between the city of Banja Luka and Čelinac, its small satellite town 15 km towards south-east. In this way we remember how Stefano Boeri raised his Filament City in Hoeksche Waard [28]: each filament followed and progressively covered the profile of the dikes, adhering to clear rules of density and extension and growing at its own pace; in each of these eleven "urban filaments" that made up the new city, the detached houses were combined with a particular activity: handicrafts, retailing, leisure, offices, sport, agriculture, etc. This example sought to anticipate and absorb the dynamics of an uncertain future, without presuming to shape them (Figure 2).

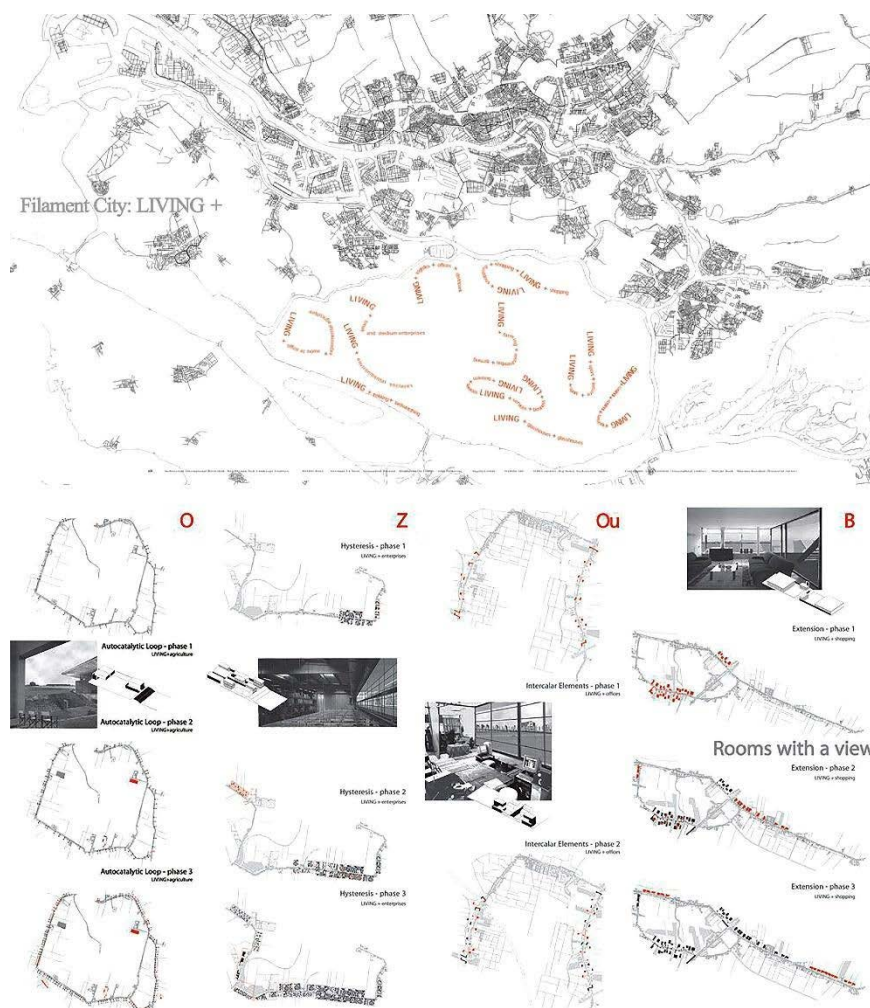

Figure 2. Bands of differentiated density Stefano Boeri. Filament City. Hoeksche Waard, Rotterdam, 1999. [29]

1.3. THE ROLE OF CYCLE ROUTES IN SUSTAINABLE URBAN MOBILITY

The rising ecological concern serves as the metanarrative of the first decades of the twenty-first century. According to above-mentioned Topalović [19], in shifting from the period of Fordist economy to the period of neoliberal globalization, the national territory has been generally abandoned as a relevant scale of planning and replaced by a more flexible or provisional idea of strategic planning and by a focus on select strategic territories. Such strategic planning is located in the framework of global sustainable development and its achievement is about making our cities more livable and our economies more prosperous while reducing carbon emissions [29]. This includes increasing care for sustainable urban mobility, which is currently recommended in the people-oriented sustainability framework of the UN New Urban Agenda [32].

One of the main problems of Banja Luka city is the traffic congestion and as a consequence, noise and pollution-related pollution. Urban transport is one of the biggest problems of modern cities for which there is no universal solution, and it has a major impact, not only on the urban form but on their livability – the quality of their natural and man-made environments [31, 32]. That is why sustainable urban mobility cannot be addressed only within the city or municipal limits and must be seen in a multidisciplinary way and with the application of the principles of integrated urban planning [33].

Urban space can be configured in a very adaptable way and it can be changed relatively quickly by restricting access to private vehicles simply with new street signaling. There have been many examples of high-quality modern pedestrian-oriented areas that were developed utilizing space previously allotted to private vehicles [34, 35].

Many cities such as Copenhagen, Amsterdam, Barcelona, Ljubljana have already started to reshape their urban infrastructure in a way that takes care of cyclists, whether that are bicycle bridges, extended bicycle paths or other facilities intended for cyclists and necessary for this type of traffic. What does the future of our cities and the traffic in them look like? Does a larger number of cyclists in cities mean a shift towards a healthier and more economical lifestyle? [36] If this is true, what will determine the citizens to ride a bicycle if the current infrastructure does not support it and if we do not have a sufficient number of adequate paths for cyclists and bike parking spaces? Architecture plays an important role in promoting sustainable urban mobility. Cities equipped with safe bicycle paths, parking lots and public bicycle facilities encourage citizens to refrain from using cars and to opt for a much more sustainable means of transport – bicycles [37].

Human scale in focus of urban planning and design has as an objective to encourage walking as an integrated urban policy aimed at developing lively, safe, sustainable and healthy cities. Pedestrian movement and cycling becomes a natural part of everyday patterns in urban activity. These can be achieved by increased concern for the human dimension in urban planning and design reflected in different requirements for quality life in a city. Cities with balanced intermodal systems provide mobility for all population groups: pedestrian and human-oriented areas that generate social and public activities, preservation of historic areas, and so forth, should be provided. The advantages of cities with intermodal systems result in more economically efficient, socially integrated, and environmentally livable cities than car-based, unimodal cities [31].

"To reduce car dependency by encouraging the use of alternative modes, the design of a development must not only protect pedestrians but make walking, transit, and bicycle use convenient and attractive. This is achieved by developing layouts with buildings that are clustered or connected by attractive walkways and with bus or rail stations in the "center of gravity" of the development-that is, with easy access to all trip-generating buildings and areas [31.]

Special lanes, paths, and bikeways are the main infrastructure element defining bicycle transportation as a distinct system. With this infrastructure, bicycle transport becomes a much more attractive mode of urban travel. It is much safer and faster than bicycle travel in mixed traffic [31]. However, this implies planning well the soft infrastructure and putting it in communication with other principles of sustainable urban mobility [30] (Table 1): a network of roads, bicycle parking, safe and affordable in the immediate vicinity of important destinations in the city, well-designed encounters with areas or pedestrian itineraries and conscious relationships with means of public transport such as buses and their intramodality. Such intermodal relations also represent a gain in economic, labor and social terms [38].

Unfortunately, bicycle transportation in Banja Luka is not developed as a distinct system. In the 1960s, Banja Luka was one of the cities in former Yugoslavia that boasted the most bicycles per capita - in 1965 it had 73,000 inhabitants and 40,000 bicycles and perfect geographical conditions for the development of bicycle traffic. Over the years, the construction of traffic infrastructure has neglected the bicycle as a means of transportation which has changed the habits of Banja Luka

residents. The city center which can be reached on foot in a maximum of half an hour and by bike even faster, was taken over by cars [39]. This is evidenced by the modest cycling infrastructure that was built. Bicycle paths are constructed only along certain routes and there is no clear and connected network that would provide opportunities for the affirmation of bicycle traffic. Apart from the small length of the paths (only 16.86 km in 2019), the problems are maintenance, occupation by improperly parked vehicles, neglected parking lots, etc. However, it is encouraging that in recent times more attention is paid to the use and promotion of bicycle traffic through the development of infrastructure projects and social actions. Study of bicycle traffic (2008) Development Strategy of the City of Banja Luka for the Period 2018-2027 [4], Action Plan for Green City [39] and the Draft of Urban Plan 2030 [38] envisage the development of bicycle traffic in accordance with the plans of sustainable urban mobility (6). In this context, the City of Banja Luka is considering different directions of network expansion. As one of the potential routes, the route Banja Luka - Celinac was imposed as a pilot project, which is the current topic of research. As the first results will show, this direction has much more value than the mere bicycle traffic development. Rich layers of cultural heritage, frequent changes of urban and natural landscapes in a very short time (short length of the section) reveal the whole universe of problems, themes and ideas, around which different narratives are imposed and new ones which could be created along the linear section of the territory.

Table 1. Degree of involvement of the cross-sectional cycle lane project in the Principles for Transport in Urban Life. (Source: Authors' elaboration based on Institute for Transportation and Development Policy (ITDP) (2011). [30])

1. Walk	a) Develop neighborhoods that promote walking
	b) Shorten street crossings
	c) Emphasize pedestrian safety and convenience
	d) Encourage ground-level activity and create places to relax
2. Cycle	a) Prioritize cycle networks
	b) Design streets that emphasize cycle safety and convenience
	c) Provide secure parking for public and private cycles
3. Connect	a) Create dense networks of streets and paths
	b) Create dense public street and path networks that are highly permeable to pedestrians, bicycles and transit
	c) Create auto-free streets, alleys, and greenways to encourage non-motorized travel
4. Transport	a) Support high quality public transport
	b) Ensure frequent, fast and direct transit service
	c) Establish at least one high capacity, high speed transit corridor with dedicated transit lines within walking distance for 80 percent of the population
	d) Locate transit stations, homes, jobs and services within walking distance of each other
5. Mix	a) Plan for mixed use
	b) Plan for an optimal balance of housing, commerce, incomes and services
	c) Provide a variety of accessible parks and open space
6. Densify	a) Match density and transit capacity
	b) Match density to the capacity of a transit system
	c) Maximize transit systems capacity to planned capacity
7. Compact	a) Create compact regions with short commutes
	b) Reduce sprawl by focusing development in areas adjacent to and within existing developments
	c) Co-locate jobs and housing within short commuting distances
8. Shift	a) Increase mobility by regulating parking and road use
	b) Limit parking to discourage driving during peak traffic periods
	c) Adjust car use fees by time of day and destination

2. METHODOLOGICAL APPROACH

2.1. THE ROLE OF CYCLE ROUTES IN SUSTAINABLE URBAN MOBILITY

The project of (re)activating the old road as a (recreational) route for cyclists and pedestrians can have positive effects on development of sustainable urban mobility plans, contribute to closer connection of two urban centers, generate many other urban projects along the route and have other

benefits. Furthermore, urban and architectural project can play an important role in generating and activating new urban routes as attraction points and finally in promoting sustainable urban mobility. The main objective of the analysis is to rethink the possibility of (re)activation of the old road Banja Luka - Čelinac as a recreational, cultural and touristic route that contains rich heritage. While mapping the territory, making an ad hoc development vision and creating urban projects in selected strategic spots, the process allows to set a series of other specific objectives. They basically derive from the methodology used and follow the research process. Those are: new reading of the territory, creating a complementary sustainable urban mobility axis, recovering connection, achieving a certain spatial cohesion, appropriating space, gaining identity (place attachment), recovering cultural heritage, creating interesting routes, achieving closer connection with the landscape and sense of belonging.

The paper is designed as the case study analysis with the two-direction approach - author's interests and teaching experience on the same subject - a linear section of the territory between Banja Luka and Čelinac alongside the Vrbanja river with the old road and the railway connecting those places in the center. The idea is to reflect on sustainable urban mobility in Banja Luka and reading of the territory that brings citizens closer to its suburban and metropolitan environment beyond being healthier and avoiding constant use of cars. The result is an offer of model options that show program and spatial-design proposals for the spatial transformation, which can be potential "triggers" for further development. Based on the analysis of possibilities and the methodology used, the study proposes a number of elements for the old road reactivation. Although focused on the specific urban situation, the study offers prototype conditions that could be relevant in similar contexts and form part of an open discussion on possible approaches to the challenge inside and outside of Bosnia and Herzegovina.

The study also gives the opportunity to interpret the territory and produce greater urban cohesion, a reading or rereading of the urban fabrics of the route to produce the recovery not only of an option of sustainable urban mobility but the reactivation of urban space around this route that recovers the public space, the landscape, rear or underused urban areas and at the same time allows balance with areas or streets that are overexploited or highly used. The project concludes with the analysis of the results of the teaching experience that guides projects along this route, to obtain criteria for their general activation, their incorporation into the sustainable urban planning and the assessment of key points for their landscape, urban and environmental design.

2.2. TWO DIRECTION APPROACH TO (RE)ACTIVATION OF THE BANJA LUKA - ČELINAC ITINERARY

This specific territory was approached from two directions. The first one is the author's research based on their interest in the urban structure and urban form of Banja Luka city, its urban periphery, informal urban fabric and hinterlands as well as the landscape of the city, territory and the water. Those interests overlapped with the actual strategic development directions of Banja Luka city stated in the Development Strategy of the City of Banja Luka (Banja Luka - capital, regional center, modern, European city, Business-Friendly, Smart City, Green City - an environment with a favorable business environment, a city of modern technologies and greenery) [4] and the Draft for the New Urban Plan of Banja Luka 2020-2040 [5]. In this framework the authors formed the research by design studio project following the concept of sustainable urban development [10] on a wider territorial scale searching for the connections between the inner urban zone and satellite neighborhoods. The second comes from the teaching experience at the Faculty of Architecture, Civil Engineering and Geodesy, University of Banja Luka. The study was performed with 22 students of the 4th-year of architecture - attendees of an elective course *Urban structure and reconstruction* during 15 weeks of the summer semester in the 2020/21 academic year. Project partners were the Center for Environment, the City of Banja Luka and the Municipality of Čelinac and European mobility week.

2.2.1. Reading the territory

The analysis is based on the blog post *Fifteen kilometers of a seemingly quite ordinary road*, by Boris Maksimović, a local author published on the *Club of travelers'* portal [41]. The most important thing about the narrative genre is its linearity, the temporal deployment of its ideas [42]. By describing the old road between Banja Luka and Čelinac, Maksimović reveals different layers of the rich cultural heritage which this specific territory condenses. Sola-Morales [42] highlights the mental importance of such a linear territory in construction of its urban map. It is a joy to follow, how the overlapping of itineraries and points, of torn cuts in the urban fabric, compose the total image of a city that, however, is always imprecise in its limits. By reading the text following the road, we read a complex history of the place that left deep traces in the territory.

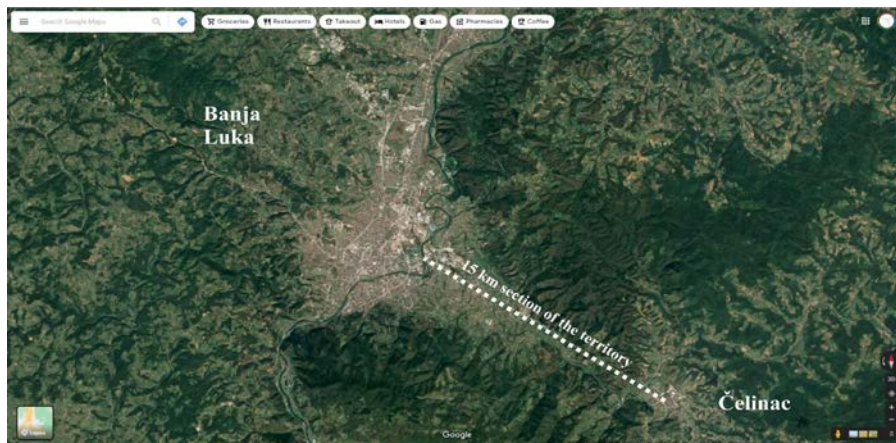

Figure 3. (left) Sketch study by Leonardo da Vinci for the decentralization of the city of Milan, 1497; (right) Street observation map, Ginza district.

By going out from Banja Luka, Maksimović describes distant views to Rebrovac, Petrićevac and Pavlovac settlements, relating their names to Bible stories. While entering Ada neighborhood he recalls the miraculous sunset viewpoints on the road from one side and high chimneys of Incel factory from the other side. In this unusual comparison, he writes about only one (known) fate of almost 15,000 former workers of the failed socialist factory. The road continues through the suburban settlements of Vrbanja and Debeljaci, where the heritage (mosques, churches and cemeteries) of Serbs, Bosniaks and Croats intertwine, testifying about the complex fate of these three peoples, their constant conflict and consequences which it has for generations. The road then crosses the railway and different sceneries appear: an old stone railway bridge over Vrbanja river on the east side, Gradina lake and Bijeli potok execution site on the west side. The mythical Zmajevac hill is above, the archeological site of an ancient fortress stands on the opposite side, the narrow-gauge railway Banja Luka-Čelinac-Maslovare is at the foot of the river, and Zeleni Vir (a large settlement, picnic area and famous beach) stretches along Vrbanja river. As a break from intensive heritage layers, a wide agricultural field opens at the end of the route, while entering Čelinac, which is urbanizing rapidly thanks to favorable living conditions near the big city.



Figure 4. Characteristic sections of the territory: (1) Exit from Banja Luka city without clear orientation towards the route direction, (2) Entering urban periphery of Banja Luka city with the huge traffic problems and dangerous conflicts, and the long sequence of peripheral landscape with tiny individual housing in informal urban fabric, (3) rural sequence with the rarely built structure and natural landscape with the rich built and natural heritage sites, (4) The end of the route in urban fabric of Čelinac.

2.2.2. Project as a method

The research-by-design method is based on simultaneous design procedures in opposing scales, assuming the overall significance of concurrent perception of the whole and its parts [42]. The methodology reveals the inherent physical layers of a given territory on a much deeper level as urban design projects communicate with a bigger scale of the city and the territory. It goes beyond the limits of the city and penetrates deeply in the landscape, making the scale as the project itself. It is research beyond the boundaries of architecture showing the importance of new interdisciplinary constellations that should be built up. The strength of the approach is design studio-project with the advantage of synthetic thinking about territory beyond narrow specialization [28]. Except for the research-based course work, the analysis goes further with a more technical investigation that overcomes the limitations of a teaching methodology. It uses the strategy of improving the landscape without building [43].

The design studio-project was set as a series of tasks arranged in an approximately regular rhythm from the simplest to the complex ones, resulting in development of conceptual design for an urban and architectural intervention on the route. The project of (Re)Activation of the old road route *Banja Luka - Čelinac in the function of sustainable urban mobility* used a series of research-by-design techniques and was designed as follows:

- Analytical part - (1) Mental map, (2) Field trip, (3) Analytical map (physical / traffic, natural, social, cultural, economic structure ...)
- Development strategy - (4) Master plan for activating itinerary with mapped locations of activation projects in the function of recreation, tourism, leisure, culture, (...) (5) Concept of planning and design approach (textual and graphic explanation) and
- Urban design - (6) the concept design proposal through (a) the situation of the selected area of intervention in relation to the immediate context (R 1: 1000) (b) Composition plan of interventions (paths, buildings, open spaces, bridges, piers, platforms, stairs, ramps, etc.) with a clearly presented design solution of functional units and all accompanying descriptions (R = 1: 1000/1: 500); (c) Characteristic bases of selected projects (R = 1: 250); (d) Characteristic cross-sections (R = 1: 250); (e) Characteristic design details (custom scale); (f) Spatial representations of selected projects (3d, montages, mock-up photos ...) and (g) Free contributions of the author's choice.

2.2.3. Mapping experience

An important means of engagement with the territory comes through ethnographic practices such as walking or cycling, for example [42]. As Sola-Morales [41] states, both moving and walking continuously belong to the territory. Territory is a social and cultural fabric that architects are familiar with. This enables the architect-researcher to identify, abstract and pinpoint a specific problem, object or idea, while remaining comprehensive. By using the notion of map design process mapping-based research methodology was created. This kind of methodology provides: Synchronization of general and specific references of the problem; Accessibility of a diverse field of external information that architects must understand and format; Interpretation of the thinking process as a means of communication and spatial performativity. By the use of the mapping tool as digital simulation, instruments of communication and a medium for exploration of spatial relationships, new possibilities and borderline values of connecting nature and architecture are emerging which, on different levels, result in changes in the character of the landscape itself [43, 44].

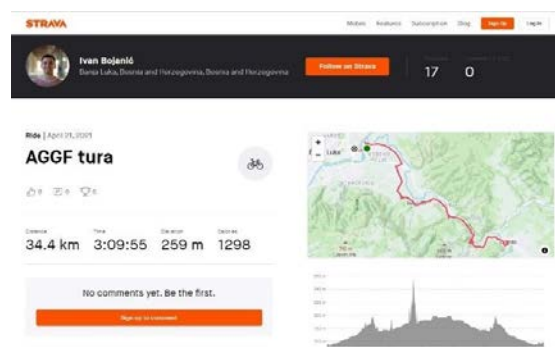

Figure 5. Recording of the Mapping done in April 2021 - the bike tour Banja Luka-Čelinac-Banja Luka guided by Ivan Bojanić (BKM) performed on April 21 (STRAVA android application, screenshot) [46].

Mapping was performed on two occasions: (1) by authors in June 2020, taking a one-day bike tour while enjoying the landscape alongside the river on a warm spring day; (2) by both authors and students in April 2021, taking a bike guided tour provided by Ivan Bojanić - a student of architecture, member of the Center for Environment, an NGO from Banja Luka [45] and a member of Banja Luka Critical Mass - a citizens' initiative created in the summer of 2017 with the aim of informing and educating all traffic participants in order to increase traffic safety, popularize bikes as a means of transport and advocate for improving cycling infrastructure and legislation. By March 2022, it had been held 44 times [45].

In promoting any idea, including project ideas and thus the idea of sustainable urban mobility, its visual presentation is very important. Regardless of the value of the idea, it is often rejected because it is incomprehensible and abstract for its consumers, i.e., the main stakeholders (local administration, local community and potential users) in everyday discourse. Therefore, project-mapping technique is used as a reflective tool for the project communication with users and a starting point for the dialogue about further possibilities regarding the subject.



Figure 6. Photo gallery of the mapping experience showing: (1) Typical situation in suburban neighborhood; (2) Dangerous conflict cross road between Medeno polje and Debeljaci neighborhood; (3) A conflict crossroads in Zelene vir and close to Zmajevac, without any orientation signs, map or urban equipment; (4) Center of Čelinac in front of the city hall without any urban equipment for bikes; (5) A section of the territory showing parallel position of the railway, the old road route and Vrbanja river; (6) heritage building of the old railway bridge in a green natural surroundings of the Vrbanja river valley. Photos by Igor Kuvač took in June 2020 and April 2021.

3. ANALYSIS OF THE RESULTS AND FURTHER DEVELOPMENT

15 kilometers of the quite ordinary road Banja Luka-Čelinac were observed in the function of connecting the city of Banja Luka and its small south-eastern satellite, the town of Čelinac, on the principles of sustainable urban mobility and territorial integrity. Conclusions were drawn following the two approaches carried out: (1) the one from the students' projects and (2) the elaboration of a cartographic type and synthesis done by the authors.

Design research process was guided towards a vision and strategic plan of the sequence of the territory and specific urban design project that relates and reflects towards the territorial scale, where the synthesis was made possible through a qualitative and contextual approach [8]. Synthesis of data was made with the aim of structuring the urban design concept of the chosen spatial framework and developing the concept of intervention. Analytical approach, creative manipulation of place and

program was the core of the task [44]. The results were evaluated throughout the whole process, from empirical investigation in situ, research, strategy development up to design [43]. At the level of strategic thinking, all development visions and master plans start from the potential of space, which is reflected in (1) natural conditions (natural morphology, continuity of the green natural structure, scenic landscape, and the flow of the Vrbanja River); (2) infrastructure potentials (four parallel traffic routes – Vrbanja river, the old road, the main road and the railway); (3) potentials of cultural heritage; and (4) spatial problems and conflicts as greatest challenges to be resolved. Master plans were made with few different development visions based on envisioning narrative itineraries of the route: Route of the river, Adrenaline route, For bike/fairytale Čelinac (ser. Za (bajk)oviti Čelinac), and Cross-train route.

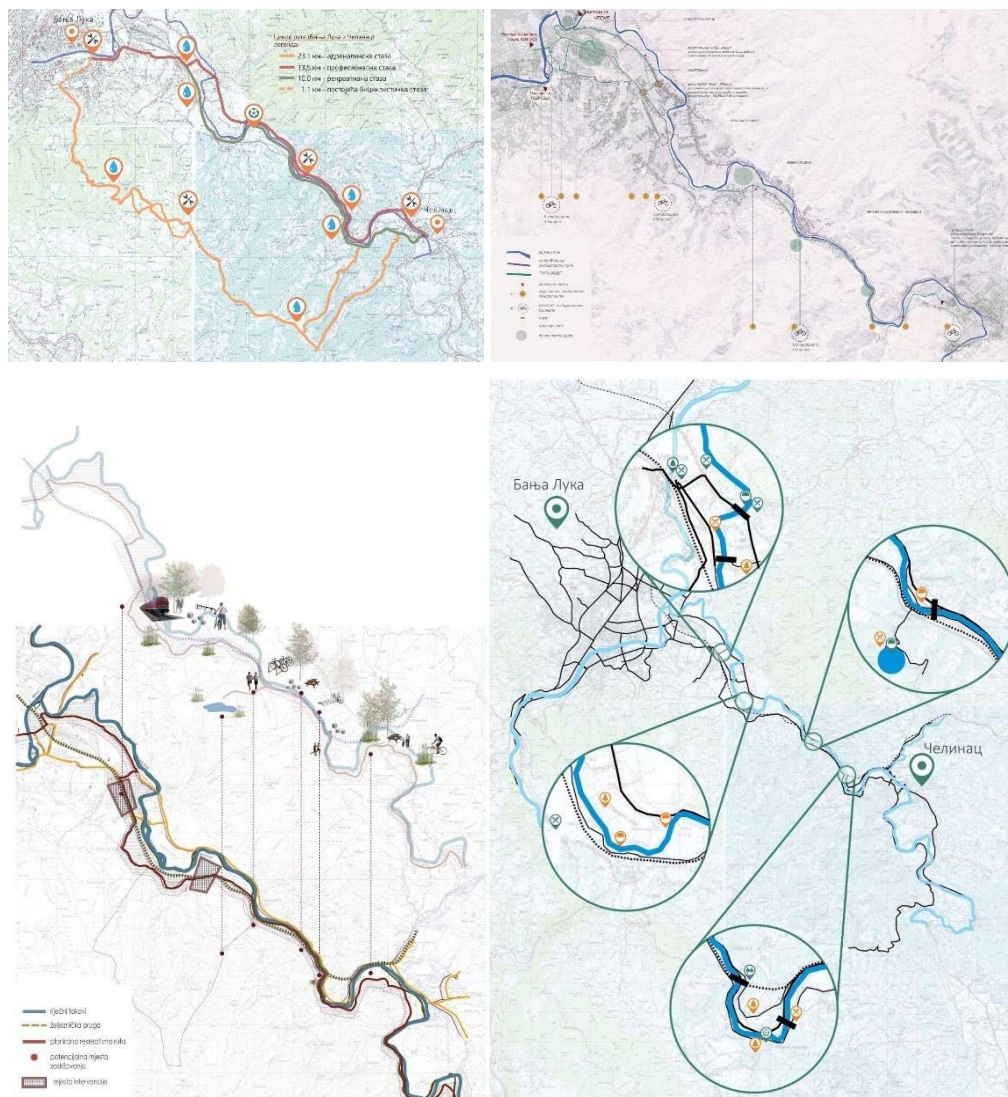

Figure 7. Master plans with the key locations showing the main problems and biggest development potentials

The mobility analysis shows a few very different sections which determine different characters of sequences and rhythm of shifts between landscapes. Except for the route gates (entrances) in Banja Luka and Čelinac characterized for their urban fabric, there are few other characteristic landscapes identified through the strategic thinking based on specific spatial patterns and potentials. Those are: (1) peripheral moments in the almost 5 km long sequence exit from Banja Luka, (2) the long sequence of the characteristic rural landscape near the big city; and finally (3) completely preserved natural landscape just before the entrance to Čelinac, a kind of greenway as Trkulja et al. define it [11].

The analysis resulted in the three main themes/ conclusions:

(1) Competitiveness. It is possible to cross 15 km by bike in about 90 minutes at an average speed of 10 km/h, which is a significant difference in speed compared to other modes of traffic on the same

route. The same route can be crossed in 15-20 minutes by car, and in 30-40 minutes by suburban bus. In addition, it is possible to use railway transport with a travel duration of about 30 minutes. The advantage of bike traffic and the proposed route is that it can be easily combined with all other types of traffic - walking, bus, railway, and even car, which contributes to the flexibility of mobility as one of the main characteristics of sustainable urban mobility.

(2) Conditionality. Regardless of the quality and justification, the success of the route project itself and its function is conditioned by numerous factors. These are: (1) networking with the existing and planned bike and pedestrian network; (2) penetration into the urban fabric of both connection places; (3) intersection with significant frequency routes of other transport modes, as potential places for intermodal terminals; (4) projects that activate strategically selected locations along the route, define its intensity and rhythm of movement; and (5) the possibility of partial use of the route, i.e. the possibility of entering and exiting several places, changing direction of movement and choosing alternative routes.

(3) Added values. The analysis shows that the activation of the 15 km long recreational route between Banja Luka and Čelinac certainly contributes to the development of sustainable urban mobility in the area. Except for the benefits of sustainable urban mobility, the reactivation of this old road has many other functions such as recreation, sports, tourism, culture, excursions, leisure, etc. On the other hand, it is the spatial development in the direction of urbanization, neighborhood construction and ancillary functions, such as secondary and tertiary centers. Furthermore, it opens many other topics in its further planning, development and use.



Figure 8. *Four types of projects: 1) Heritage; 2) Facility; 3) Mobility; 4) Public space*

3.1. CARTOGRAPHIC APPROXIMATION

About 20 urban-architectural projects dealt with the activation of several cultural, tourist, sports-recreational and finally bike routes along this old road. The projects try to respond to the needs of modern life of people and their mobility in cities with a focus on enjoying the abundance of open space, rich natural structure and layers of cultural heritage. Very different typologies deal with slowing down the traffic, intermodal traffic terminals, services, recreational and other centers in the function of healthy ways of movement and sustainable use of space. They are complemented by small-scale projects such as viewpoints, beaches, river approaches, etc. Projects are grouped into a few different solution packages depending on the scale and objectives: (1) mobility, (2) heritage, (3) public space and (4) facilities.

4. CONCLUSIONS AND RECOMMENDATIONS

The results demonstrate the strength of the methodology used and confirm the success in thinking about sustainable urban mobility and the spatial polygon of research. Therefore, the methodology set, and the conducted experiment can be a good example for thinking about this and other similar areas in other contexts, and that it can have positive effects on the development of the territory in the desired directions. The methodology carried out has possibilities for the orientation of "urban policies" aimed at improving sustainable mobility (proposing different types of public transport and their mutual adaptation, and the development of intermodal terminals); the urban environment, urban

cohesion, the recovery of heritage, the incorporation of collective urban functions, etc. The three main conclusions were drawn as a project as a tool, problem-solving project and landscape project.

Table 2. Relation between the project type, the specific approach to the territory and the intensity of contribution to the specific objective (problem-orientation). M- Mobility; P- Public space; H- Heritage; F- Facility. Darkest gray- the most intensive relation; Lightest gray- the less intensive relation.

PROJECT	T Y P E	DETAILS	M	P	H	F
Adrenaline route	M	Master plan with a few small-scale supporting projects providing a new alternative route with a stronger intensity.	darkest gray	light gray	light gray	light gray
Traffic bypass	M	Slow down the motor traffic in a sequence by giving advantage to biking and walking and providing the possibility to use facilities and enjoy the landscape and heritage by the road.	darkest gray	light gray	light gray	light gray
Cycling passarella	M	A bike and pedestrian shortcut from Medeno polje to Debeljaci avoiding the traffic jam at the busiest sequence of the main road.	darkest gray	light gray	light gray	light gray
Intermodal terminal 01 and 02	M	Existing train or bus stops are merged into one intermodal stop with additional bike stops and supporting facilities plugged in.	darkest gray	light gray	light gray	light gray
Public beach in Česma neighborhood.	P	Urban design project for the confluence of the Vrbanja and the Vrbas, large open green area from where the route continues to develop.	light gray	darkest gray	light gray	light gray
Landscape Gate in Česma neighborhood.	P	Urban design project treats a wide area on both sides of the Vrbanja river, which in a complex system combines pedestrian and bike communications and directs them to Čelinac and other places in the Vrbanja valley.	light gray	darkest gray	light gray	light gray
Public beach in <i>Zeleni vir</i> neighborhood.	P	The central place is one of the biggest neighborhoods on the route and one of the most popular river beaches in the area.	light gray	darkest gray	light gray	light gray
Multifunctional modular stops	P	Two projects which offer additional functions on strategic points on the route. Their modularity opens up flexible organization.	light gray	darkest gray	light gray	light gray
Old railway bridge viewpoint 01 and 02	H	The most attractive heritage building attracts two view point projects to enjoy both natural and cultural heritage layers and bike stops.	light gray	darkest gray	darkest gray	light gray
<i>Zeleni vir</i> viewpoint	H	The conflict crossroad becomes both a viewpoint, bike stop, an orientation and tourist info point.	light gray	darkest gray	darkest gray	light gray
Vrbanja river viewpoint	H	One of few public space projects with focus on natural heritage of Vrbanja river and its beauty to enjoy the landscape and the territory itself while commuting	light gray	darkest gray	darkest gray	light gray
Adrenaline park	F	A complementary project to the adrenaline route, an alternative route connecting Banja Luka and Čelinac via the Ponir hill	light gray	light gray	darkest gray	darkest gray
Bike service stops	F	Bike sharing system, service and parking stops supporting the bike route	light gray	light gray	light gray	darkest gray

4.1. PROJECT AS A TOOL

We conclude that the project is a powerful tool to make a positive shift in observing, thinking, imagining and envisioning territory, and finally, in researching and planning. By using three-dimensional presentation in numerous iterations and variations, it is possible to observe previously unseen, unbelievable and to open completely unexpected perspectives. Starting from the only one premise, the project can spare to immense opportunities. Projects consider the importance of qualitative characteristics of a given territory.

4.2. PROBLEM-SOLVING PROJECT

The project itself cannot contribute to everyday home-work commute on the Banja Luka - Čelinac route as it took too much time compared with other types of transport and the scale of the area. It is concluded that the route along its entire length is primarily recreational and cultural and as such has also an important role in sustainable urban mobility development. Except for contributing to sustainable urban mobility, the project itself has many other substantive qualities and dimensions, which is worth for. It is an urban project that addresses a range of spatial issues and conflicts. They are classified into four project groups:

- Mobility projects are highlighting entrances and exits from the city; traffic solving of problematic intersections, crossings over the main road M4 (Banja Luka - Doboj), crossings over the railway in several places, etc. The project also contributes to the development of a network of recreational routes, their networking in intercity and regional directions of movement; directing the movement of cyclists outside the narrow urban area towards a natural and healthier environment, etc.
- Public space projects are highlighting the potential of a vast open public space along the road following the river. In addition to activating open space, they contribute to improving the ambient quality and increasing the tourist offer.
- Heritage projects are concentrated on activation of specific places with the values of natural or cultural heritage. They emerge on strategic points to highlight important viewpoints to protect and to enjoy the heritage in the same time providing a kind of sustainable urban mobility services.
- New facilities projects are focusing on facilitating the usage of the route at specific locations giving them basic utilitarian functions as intermodal terminals, urban equipment and mobiliary, bike services, bike sharing spots and bike parking places.

4.3. LANDSCAPE PROJECT

Finally, it is a landscape project. Surrounded by a natural landscape, but also historical and cultural layers, it is a unique landscape alley characterized by a mild undulating morphology, a rhythm of fine curves, a shift of the green structure of the courtyards, forests, fields, orchards, river banks and informal suburban settlements. By development of an urban route, urban territory is connected with the surrounding natural landscape. This is especially important as landscapes and hinterlands represent significant and necessary spatial potential of the city. The idea of the surrounding natural landscape of the city can serve as a key common ground for its development especially in the function of recreation. The strength it has for an urban form due to the continuity of a certain line, of the section of the territory of a certain axis.

ACKNOWLEDGEMENTS

This paper includes students' work, which was created during the Elective course Urban structure and reconstruction at the Faculty of Architecture, Civil Engineering and Geodesy, University of Banja Luka led by Malina Čvoro and Igor Kuvač, with guests Jelena Hrgar Pavlović (The City of Banja Luka), Tihomir Dakić (Center for Environment) and student Ivan Bojanić (Bike tour guide).

LITERATURE

- [1] B. Milojević and I. Kuvač, "Recognizing Principles of Integrated Urban Planning in Historical Development of the City: A Case Study of Banja Luka," *Journal of Urban History*, July, 2021. DOI: <https://doi.org/10.1177/00961442211030624>,
- [2] D. Simonović and M. Ralević, "Savremena urbana naselja između sela i grada", *Ljetna škola urbanizma – Šipovo 2000. god. (Banja Luka: UZRS, 2000)*, pp. 113–133.
- [3] I. Kuvač, and I. Karan, „Searching for Sustainable Development of Residential Areas in Bosnia and Herzegovina City: Formal versus Informal Urban Fabric,“ in *Conference Proceedings of 6th Sustainable Development Symposium*, 2016, Granada: Faculty of Architecture.
- [4] “Strategija razvoja Grada” [City Development Strategy], City of Banja Luka, Available: <http://www.BanjaLuka.rs.ba/gradska-uprava/strategija-razvoja-grada/> [May 9, 2018]
- [5] “Urbanistički plan Banja Luka 2020-2040” [Urban plan Banja Luka 2020-2040], City of Banja Luka, Available: <https://upbanjaluka.com/> [Mar. 15, 2022]
- [6] „SUMP for City of Banja Luka Developed within Project CHESTNUT“ – Comprehensive Elaboration of Strategic plans for sustainable Urban Transport.

- Available: https://civinet-slohr.eu/wp-content/uploads/2015/09/4_Koncepcija-Plana-odrzive-urbane-mobilnosti-Banja-Luke.pdf [Mar. 15, 2022]
- [7] D. Simonović, "Rehabilitation of urban identity of cities in the Banja Luka region through urban form regulation". *SPATIUM International Review*, 30(12), pp. 28-32.1, 2013.
- [8] I. Kuvač and M. Schwai, "Three elements of construction of spatial identities in Mađir (Banjaluka, Bosnia and Herzegovina) and Ilsvika (Trondheim, Norway) neighborhoods". *Urbani izzvi / Urban Challenge* 28(1) pp. 83-95, 2017. ISSN: 0353-6483.
- [9] И. Кувач, И. Каран, "Нови концепт урбаног развоја Бањалуке: Између приватних интереса и потреба грађана" у *Нови концепт урбаног развоја Бањалуке: између приватних интереса и потреба грађана [Зборник радова]*, у Р. Перић-Ромић, и Д. Савић, ур. Бања Лука: Универзитет у Бањој Луци, Факултет политичких наука, 2018. Стр. 33-56.
- [10] B. Milojević, I. Kuvač, I. Karan. "Qualities of resilient cities in systems of planning sustainable urban development. An introductory review." in *Proceedings of the Conference Places and Technologies*, A. Krstic-Furundzic, A. Djukic M. Vukmirovic, ed. Belgrade: Faculty of Architecture, University of Belgrade, 2018. pp. 634-640.
- [11] T. Trkulja, Lj. Došenović, and N. Matić. „Greenways as an Element of Urban Planning: Banja Luka Case Study,“ *Facta Universitatis Series: Architecture and Civil Engineering* 16 (3), 2018. pp. 501–515.
- [12] C. Cavalieri, "Horizontal Metropolis: Theories and Roots, a Transcultural Tradition Introduction," in *The horizontal metropolis: between urbanism and urbanization*. P. Viganò, C. Cavalieri and C. Barcelloni, Ed. Cham, Switzerland: Springer, 2018, pp. 13-18. Available: https://www.researchgate.net/publication/324949420_The_Horizontal_Metropolis_Between_Urbanism_and_Urbanization
- [13] N. Katsikis, "The 'Other' Horizontal Metropolis: Landscapes of Urban Interdependence," in *The Horizontal Metropolis Between Urbanism and Urbanization*. P. Viganó, P., C. Cavalieri, C. Barcelloni, Ed. Springer, 2018, pp. 23-45. Available: [10.1007/978-3-319-75975-3_3](https://doi.org/10.1007/978-3-319-75975-3_3)
- [14] B. Secchi, "Un programa de búsqueda," *Casabella*, vol. 497, pp. 24-25, dec. 1983.
- [15] T. Fujimori, "Under the Banner of Street Observation". *Forty-Five - A Journal of Outside Research*, June 2016. Available: <https://forty-five.com/papers/under-the-banner-of-street-observation> [Mar. 15, 2022]
- [16] G. Akasegawa, T. Fujimori, and S. Minami, *Rojō kansatsugaku nyūmon* [Street Observation Studies Primer]. Tokyo: Chikuma Shōbō, 1986.
- [17] L. Vecslir, "Paisajes de la nueva centralidad," *Urban*, vol. 12, pp. 34-55, june 2011. Available: <http://polired.upm.es/index.php/urban/article/view/460>
- [18] G. Simmel, *El individuo y la libertad: ensayos de crítica de la cultura*. Barcelona: Península, 2001, p 46.
- [19] M. Topalovic, "The Architecture of the Territory?" *Cartha*. Vol. 2 "The form of form" II, n° 33, 2016. Available: <https://www.carthamagazine.com/issue/1-2/> [Mar. 15, 2022]
- [20] A. Corboz, "Le territoire comme palimpseste," *Diogenes*, vol. 121, pp. 14-35, 1983.
- [21] J.L. Rivas-Navarro, "Fighting the myth and nostalgia: Collective databases for a creative city in the Vega of Granada," in *Proceedings of International Academic Conference BROWNINFO*, A. Đukić, M. Stanković, B. Milojević, & N. Novaković, eds. Banja Luka: Faculty of Architecture, Civil Engineering and Geodesy Banja Luka, University of Banja Luka, 2014, pp. 137-146. Available: https://www.academia.edu/32599668/Fighting_the_myth_and_nostalgia_Collective_databases_for_a_creative_city_in_the_Vega_of_Granada
- [22] M. de Solà-Morales i Rubio, "Ciudades cortadas," in *De cosas urbanas*. M. de Solà-Morales i Rubio, Ed. Barcelona: Gustavo Gili, 2008, 174-183.
- [23] J.L. Rivas Navarro, *Fundación de la tesis: la travesía más transparente. La visión de Córdoba, Málaga y Granada desde su calle ciudad*. Granada: Universidad de Granada, Dec. 2009, pp. 137-146. Available: <https://digibu28g.ugr.es/handle/10481/19760> [Mar. 15, 2022]
- [24] K. Lynch, *La imagen de la ciudad*. 7ª ed. Barcelona: Gustavo Gili, 2006.
- [25] R. Ingersoll, *Sprawltown: Looking for the City on its Edges*, New York: Princeton Architectural Press, 2006.

- [26] G. Dematteis, "En la encrucijada de la territorialidad urbana / Sul crocevia della territorialità urbana," *Bitácora Urbano Territorial*, vol. 10(1), pp. 53-63, 2006. Available: <https://dialnet.unirioja.es/servlet/articulo?codigo=4014205>
- [27] D. Cabrera-Manzano, C. Martínez-Hidalgo and M.I. Rodríguez Rojas, "Itinerarios narrativos metropolitanos," presented at XVI Convención científica de ingeniería y arquitectura, Granada, Spain, 2012. Available: <https://digibug.ugr.es/handle/10481/23334> [Mar. 15, 2022]
- [28] S. Boeri, "Filament City," *Lotus*, vol. 107, pp. 128-131, 2000.
- [29] S. Boeri, "Filament City," Internet: <https://www.stefano-boeri-architetti.net/en/project/filament-city/>, 1999 [Mar. 15, 2022].
- [30] Institute for Transportation and Development Policy (ITDP). (2011, Aug.). *Our Cities Ourselves: Principles for Transport in Urban Life*. [On-line]. Available: <https://www.itdp.org/2011/08/29/our-cities-ourselves-principles-for-transport-in-urban-life/> [Mar 15, 2022].
- [31] V.R. Vuchic, *Transportation for Livable Cities*. London and New York: Routledge, 2017
- [32] UN-Habitat, *New Urban Agenda*, Quito: ONU. Available: <https://habitat3.org/wp-content/uploads/NUA-English.pdf> [Feb 2, 2018].
- [33] J. Gehl, *Cities for People*. Washington: Island Press, 2010.
- [34] A.L. Grindlay, G. Ochoa-Covarrubias, and C. Lizárraga, "Sustainable Mobility and Urban Space Quality: The Case of Granada, Spain," *Int. J. Transp. Dev. Integr.*, vol. 5(4), pp. 309–326. Available: <http://dx.doi.org/10.2495/TDI-V5-N4-309-326>
- [35] M. Vukmirović i J. Vukmirović, „Pešačko kretanje u funkciji unapređenja javnog gradskog prostora i javnog zdravlja u Beogradu,“ Oktobar 2014. [On-line]. Available: file:///D:/KORISNIK/Downloads/Pesacko_kretanje_u_funkciji_unapredenja_javnog_gradskog_prostora_i_javnog_zdravlja_u_Beogradu.pdf
- [36] L. Bertolini, *Planning the Mobile Metropolis: Transport for People, Places and the Planet*, London: Macmillan International Higher Education, 2017.
- [37] A. Carrillo-Domínguez, A. F. Carrillo-Domínguez, E. Herrera-Narváez, and E. Tzuc-Salinas. (2015). *Guía para la Promoción de Espacios Biciamigables*. [On-line]. Available: <https://archive.org/details/GuiaParaLaPromocionDeEspaciosBiciamigables/page/n11/mode/2up?view=theater>
- [38] T. Gatarić, „Kako je Banja Luka izgubila priliku da postane grad biciklista?“ Internet: <https://ba.voanews.com/a/banjaluka-biciklizam-izgubljena-prilika/5614901.html>, Oct. 9, 2020. [Mar 15, 2022].
- [39] Atkins, „Green City Action Plan for Banja Luka,“ Internet: <https://ebrdgreencities.com/assets/Uploads/PDF/8cbc92568c/EBRD-Banja-Luka-GCAP-EN.pdf> [Apr. 22, 2022].
- [40] Narrative base. Available: <https://www.klubputnika.org/zbirka/putopisi/3839-petnaest-kilometara-sasvim-obicnog-puta>. [Mar. 15, 2022].
- [41] M. Sola-Morales, *M W, I raconti deffabitare*, Milán: Abitare Segestacataloghi, 1994.
- [42] A. Nikezić, P. Stamenović, and N. Janković, 2017. „Transgressing Scale: Architecture and nature: ECO Station, War Island, Belgrade,“ in *Conference Proceedings Fifth International Conference and Exhibition within International Multimedia Event ON ARCHITECTURE*, R. Bogdanović, ed. Belgrade: STRAND—Sustainable Urban Society Association Belgrade, Dec. 2017, pp. 123–131.
- [43] P. Stamenović, Đ. Bulajić, *Narrative spatial analytics (NSA) in urban landscape research and design*. [On-line]. Available: https://www.researchgate.net/publication/349425900_Narrative_spatial_analytics_NSA_in_urban_landscape_research_and_design?fbclid=IwAR0IXSaz_ND_1OGG2khKTIGb-1MaF_njdRRjoDsFNaWBAhBMT3902MXj2aA#fullTextFileContent [Feb. 22, 2021]
- [44] C. Steenbergen. *Composing Landscapes*. Basel: Birkhauser Architecture, 2008.
- [45] Banja Luka Critical Mass. Available: <https://czzs.org/banjalucka-kriticna-masa/>; <https://www.facebook.com/BanjaluckaKriticnaMasa/> [Mar. 15, 2022].
- [46] Internet: https://www.strava.com/activities/5166453439?share_sig=1GHE8JWG1619014185&utm_medium=social&utm_source=android_share [Apr. 21, 2022].

22

Research paper | Оригинални научни рад
DOI 10.7251/STP2215234V
ISSN 2566-4484



Tijana Vujičić, University of Banja Luka, tijana.vujicic@aggf.unibl.org

SHRINKING RURAL AREAS OF REPUBLIC OF SRPSKA

Abstract

Globalization produced a disparity manifested through spatial polarization - growing and shrinking territories. Shrinkage is an increasingly global phenomenon that affects cities, villages, and entire regions around the world. Population loss and economic decline make these areas vulnerable - its vitality and sustainability are endangered. Starting from the assumption that the rural areas are particularly affected by shrinkage, this research addresses stagnant trends in the northwest region of Bosnia and Herzegovina. The aim of this research is to identify and assess the level of rural shrinkage in the region, as well as to underline directions for future action in response to these negative trends. The results of the research are presented cartographically using Arc GIS software.

Keywords: shrinkage, village, population, households, dwellings, GIS

СТАГНАЦИЈА РУРАЛНИХ ТЕРИТОРИЈА РЕПУБЛИКЕ СРПСКЕ

Сажетак

Глобализација је произвела диспаратитет и просторну поларизацију манифестовану кроз појаву полова стагнације и полова раста. Стагнација постаје све глобалнији феномен који погађа градове, села и цијеле регије. Губитак популације и економски пад чине ова подручја рањивим, а њихова виталност и одрживост су уржени. Полазећи од претпоставке да су рурална подручја посебно погођена смањењем, ово истраживање се бави стагнантним трендовима у сјеверозападној регији Босне и Херцеговине. Циљ истраживања је да се идентификује и процијени степен стагнације руралних подручја региона и да се укаже на правце будућег дјеловања. Резултати истраживања су приказани картографски коришћењем Arc GIS софтвера.

Кључне ријечи: стагнација, село, популација, домаћинства, станови, ГИС

1. INTRODUCTION

The shrinking phenomenon has been researched extensively in literature since the early 21st century. Studies show that as early as the late 1990s, the phenomenon of shrinkage, manifested in population loss and economic decline, was more pronounced than the phenomenon of urban growth and development [1]. Scientists believe that the emergence of this phenomenon was primarily caused by changes in the global economy [2] and second demographic transitions [3]. The global economic competition has resulted in spatial polarisation in which the metropolitan development areas of cities stand out, while on the other hand, a large number of cities have faced the problem of shrinkage. On the other hand, post-industrial society, by changing the way of life, which primarily implies the postponement of parenthood, indirectly causes a decline in natural population growth and aging of the population, and ultimately its decline. Although this phenomenon shows universal (global) characteristics, with multidimensional effects in the social, economic and physical domains, however, the forms of shrinkage and its dynamics largely depend on local specifics. Given that the shrinking phenomenon is relatively new, the affected countries are developing recovery strategies, where fostering social dialogue between different stakeholders (academia, businesses, local bodies, citizens, NGOs) is one of the key elements and first step toward the regeneration. The Knowledge Alliance for Social Innovation in Shrinking Villages (KINESIS) is one of the international cooperation platforms that is focused on shrinking areas since it creates an international living lab to exchange best practices and innovative ideas developed across Europe [4].

The scale of this phenomenon at the global level has been discussed in the international studies and projects from the beginning of the 21st century [5, 6], while at the local level in Bosnia and Herzegovina (B&H), only individual scientific research has been conducted [7, 8]. The focus of all these studies was primarily on the stagnation of urban areas – cities, while the analysis of the rural territory was in the background. The more recent study conducted by the European Spatial Planning Observation Network (ESPON) puts focus on the shrinking rural areas [9]. This research shows that the countries of Southeast Europe are particularly affected by rural shrinkage, but B&H and its neighboring non-EU countries are not covered by this study. Considering that Bosnia and Herzegovina is a low-urbanised country [10] with dominant rural areas, research focused on the shrinkage not only of cities but also of rural areas are essential for understanding of this phenomenon, its spatial dynamic and distribution at regional level. In order to adequately deal with the problems caused by stagnation, society primarily needs to identify and map shrinkage patterns and assess its extent.

Therefore, this paper deals with the identification and mapping of shrinkage patterns in rural areas of Bosnia and Herzegovina. It is assumed that in the period after the civil war in B&H, decline was a more dominant process than the process of growth and development and that most villages in the northwestern (NW) region were affected by shrinkage. The research polygon includes the territories of the villages of 19 municipalities in the northwestern region of Bosnia and Herzegovina, which territorially and administratively belong to the Republic of Srpska (RS) as an independent entity. The research covers movement of population, households and dwellings taken from official censuses. The results of the research were presented cartographically using ArcGIS software. The aim of the research is to identify the extent of shrinkage in rural areas and to investigate the spatial dynamic of this phenomenon. Additionally, the paper discusses the causes and consequences of stagnation and highlights limitations in research.

2. METHODOLOGY

The research of the shrinking phenomenon includes the analysis of census statistics for rural areas of 19 municipalities in the northwestern region of Republic of Srpska – Bosnia and Herzegovina: Banja Luka, Brod, Gradiška, Derventa, Doboje, Kneževci, Kozarska Dubica, Kotor Varoš, Laktaši, Modriča, Mrkonjić Grad, Novi Grad, Prijedor, Prnjavor, Srbač, Teslić, Čelinac, Šamac and Šipovo. The research addresses the identification, assessment and mapping of stagnant trends, as well as the typological classification of municipalities affected by rural shrinkage. The analytical framework of rural shrinkage research is defined by determining: 1) criteria relevant for assessing rural stagnation, 2) shrinking indicators, 3) thresholds for selected criteria in relation to which rural decline or growth is identified and 4) time frame reference for identified problem. The criterion of data availability is set as an additional criterion that accompanies the analysis according to the previous elements.

The key criteria for conducting the research are population size, number of households and number of dwellings, monitored through official census statistics [11, 12, 13]. The population includes citizens of Bosnia and Herzegovina i.e. people whose place of residence have been in municipalities

of NW region of Republic of Srpska from 1953 to 2013. The household implies a family or a single-person household, who occupies the entire dwelling unit or its part. The dwelling is a self-contained construction unit intended for housing.

Data by certain criteria for rural areas are obtained through parameters that are defined for the corresponding census year as the difference between the total value for the municipality and the value for the city. More precisely, this difference represents the total value for a certain parameter for all villages of one municipality for a certain census year – in summary. For example, the population of the villages of Banja Luka in 2013 was 44 994 inhabitants, which is the difference between the total population of the municipality (180 053) and the population of the city (135 059). In order to gain a clearer picture of the phenomenon, its characteristics, as well as to understand the changes and basic dynamic patterns it is preferable to monitor the growth-decline flows of the village in extensive time periods. Therefore, a sixty-year period (1953-2013), with three timeline in the years of official censuses (1953, 1991 and 2013), was defined as a broader time frame for monitoring total trends according to all criteria. Observing the growth-decline flows as dynamic nonlinear processes, it is very important to define tipping points in the evolutionary flow of the village. The civil war 1992-1995 is indisputably an important tipping point in the area of B&H and RS. Therefore, the research draws parallels and defines changes in relation to the period before and after the war in all aspects important to the topic. Based on preliminary research on this phenomenon, it is assumed that the key stagnant changes occurred after the civil war in B&H, i.e. after the 1991 census. Hence, this 22-year period from 1991 to 2013 is chosen as a reference time frame for indicating shrinkage and testing the hypothesis. The key indicator of rural shrinkage is defined as a decline by any criterion greater than 0.15% per annum in the period 1991-2013, or decline higher than 3% in the total period of twenty-two years (the time between two censuses). In addition to stagnant trends, villages can record stable trends from -0.15% to + 0.15% per annum, and increasing trends $> + 0.15\%$ per annum. Observed in the total period from 1991 to 2013, changes ranging from -3% to + 3% indicate stable states, and those over 3% indicate growth trends.

In international studies dealing with the shrinking cities (CIRES and Shrinking Cities), the main criterion for their classification was the level of population decline [5, 6]. Following the example of the previously mentioned studies, this research classifies municipalities according to the level of shrinkage of their rural territories. Specifically, municipalities are classified based on the percentage decline of the rural population for the total 22-year period according to the following model:

- 3% - 10% - rural areas with a very low level of decline
- 10% - 25% - rural areas with a medium level of decline
- 25% - 50% - rural areas with a high level of decline
- 50% - 75% - rural areas with a very high level of decline
- Over 75% - extinction of village

The classification of growth trends is carried out by analogy with the classes defined for decline. Additional (sub)classifications of declining villages can be made on the basis of two other criteria – the number of households and the number of dwellings. These two criteria help to better understand the spatial consequences of shrinkage and assess the level of use of the existing housing stock. The results of the research are presented cartographically using ArcGIS Pro software.

3. RESULTS

According to the proposed model, the research was conducted, which is presented in the text below separately for each of the criterion. Key relations and comparisons of results are based on two time periods, 1953-1991 (38 years) and 1991-2013 (22 years). Due to the lack of official statistics for dwellings in the 1953 census year, the analysis according to this criterion was performed on the basis of the 1971 census. Each of the cartographic representations incorporates the classification of municipalities according to a previously defined key.

3.1. POPULATION

The results of the conducted research show that the population of rural areas in the region in the period 1953-1991 increased by a slight 2%, while in the period 1991-2013 it decreased by 37%, i.e. the villages of the region lost a total of 231 836 inhabitants. In the period 1953-1991, the decline in population was most pronounced in the municipalities of Mrkonjić Grad (34%) and Šipovo (31%), while the most pronounced growth was recorded in the municipalities of Kotor Varoš (34%) and Teslić (44%). However, it is evident that in most municipalities in the region there has been a more pronounced decline in rural population than its growth in this period – 10 municipalities recorded a decline in population, in one of which population is stable, while 8 municipalities recorded growth (Figure 1). In the period 1991-2013, four municipalities faced a decline in population in rural areas in the range of 50-75%, eight of them with a decline of 25-50%, and four with a decline of 10-25%. Only Laktaši recorded a rural population growth of 10%. The average annual decline of the total rural population of the region in this 22-year period is 2%.

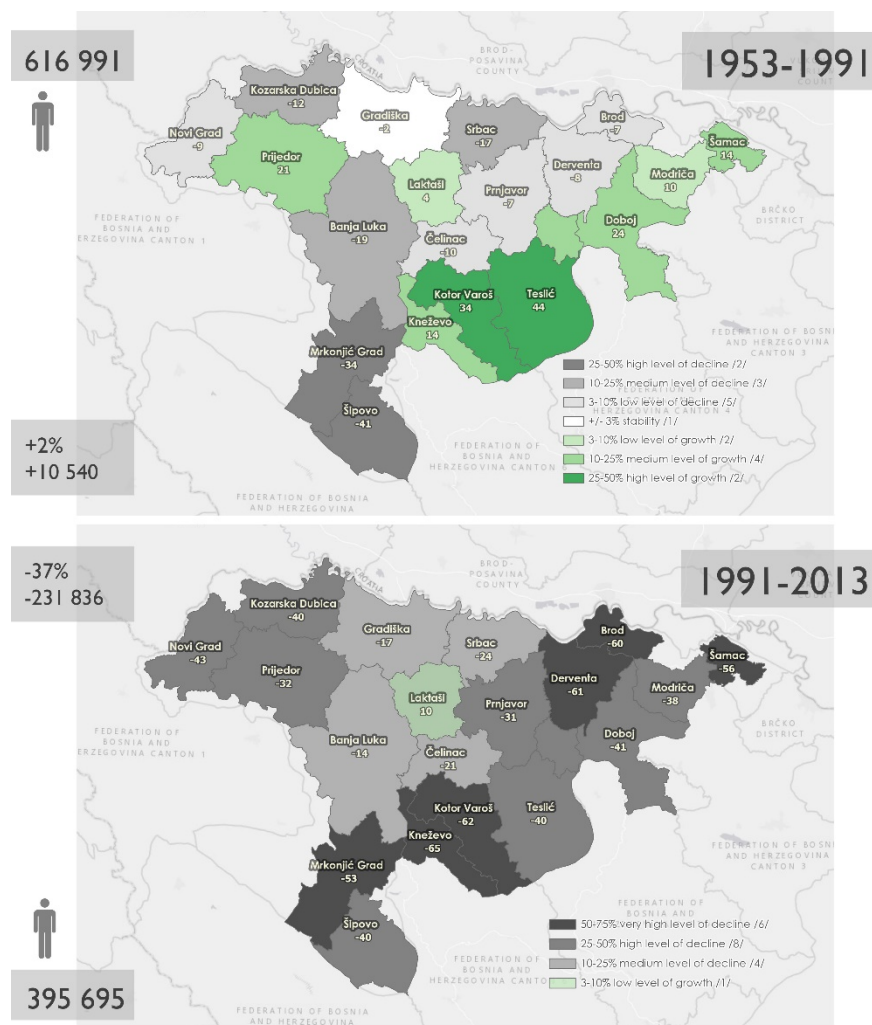

Figure 1. Population growth and decline trends per villages of NW region of RS 1953-2013

Considering the total population movements at the level of villages and cities in both reference time series, it is noticed that in the period 1953-1991 the urban population grew, while in the period 1991-2013 there was a decline in population at both levels (Figure 2). However, the B-chart shows a much more radical decline in the rural population compared to cities in the same period. In the period 1953-1991, the total population of the region, both urban and rural, increased by 34% (+ 250 229), while in the period 1991-2013 an evident decline of 29% (281 261) was recorded.

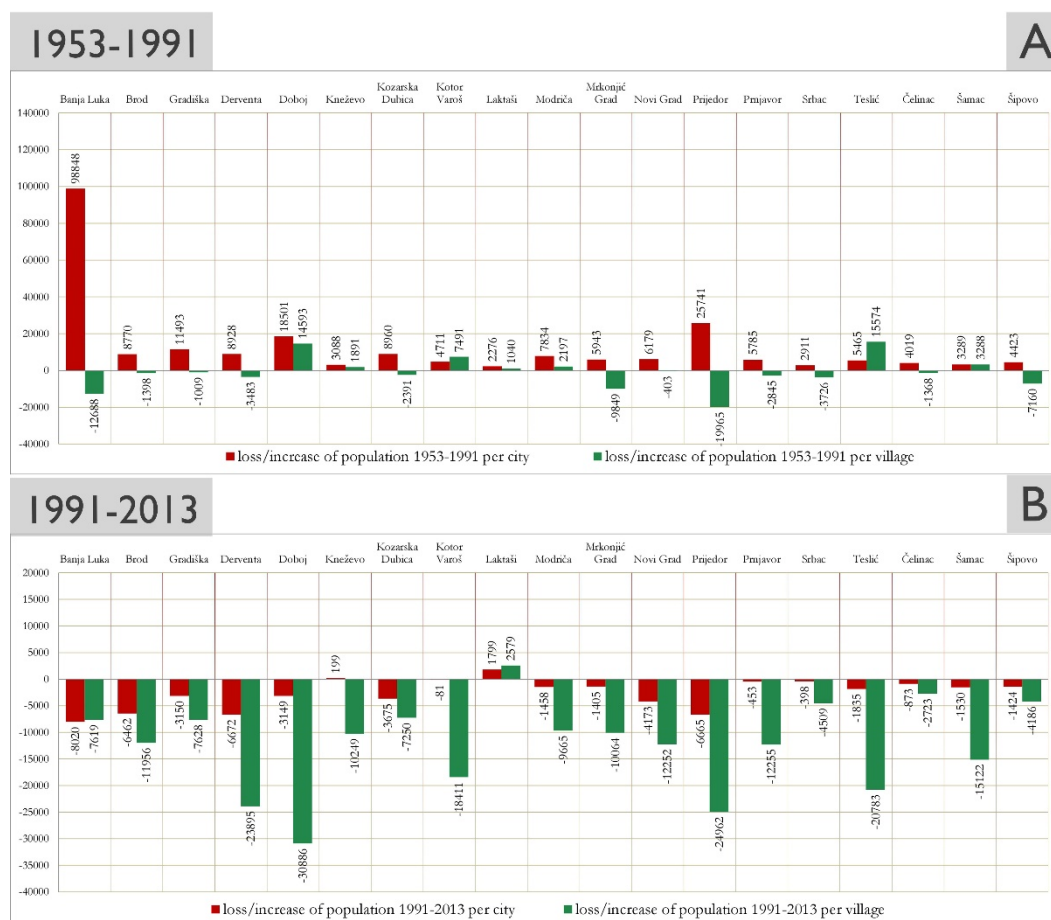

Figure 2. Growth / decline of urban and rural population for the periods 1953-1991, 1991-2013.

3.2. HOUSEHOLDS

Statistics for households show slightly different trends in relation to population movements, especially in the period 1953-1991. Namely, in this period the number of households in rural areas of the region increased by 51% (+ 57 750 households), while in the period 1991-2013 a total decrease of 19% was registered (-32 491) (Figure 3).

In the pre-war period, the number of households in all municipalities in the region increased to a smaller or higher percentage. Teslić had the highest growth in the number of households of 141%, while Kneževo (77%), Kotor Varoš (99%) and Doboj (91%) recorded extremely high growth. The lowest growth was registered in Kozarska Dubica (7%) and Šipovo (4%). In the period 1991-2013, 16 municipalities in the region recorded a decline in the number of households. Derвента and Brod had the most pronounced decline of 50%, Gradiška moved within stable limits, and Banja Luka (8%) and Laktaši (26%) had pronounced development trends and an increase in the number of households. The region lost 1 477 rural households each year in the 22-year period, and the average annual decline in the total number of rural households in the region is 0.87%. Household size has changed radically over the entire 60-year period. The average rural household had 5.5 members in 1953, 3.7 in 1991, and 2.9 members in 2013. At the same time, the size of the average household in urban areas was 3.9 members in 1953, 3.2 members in 1991, and 2.7 in 2013.

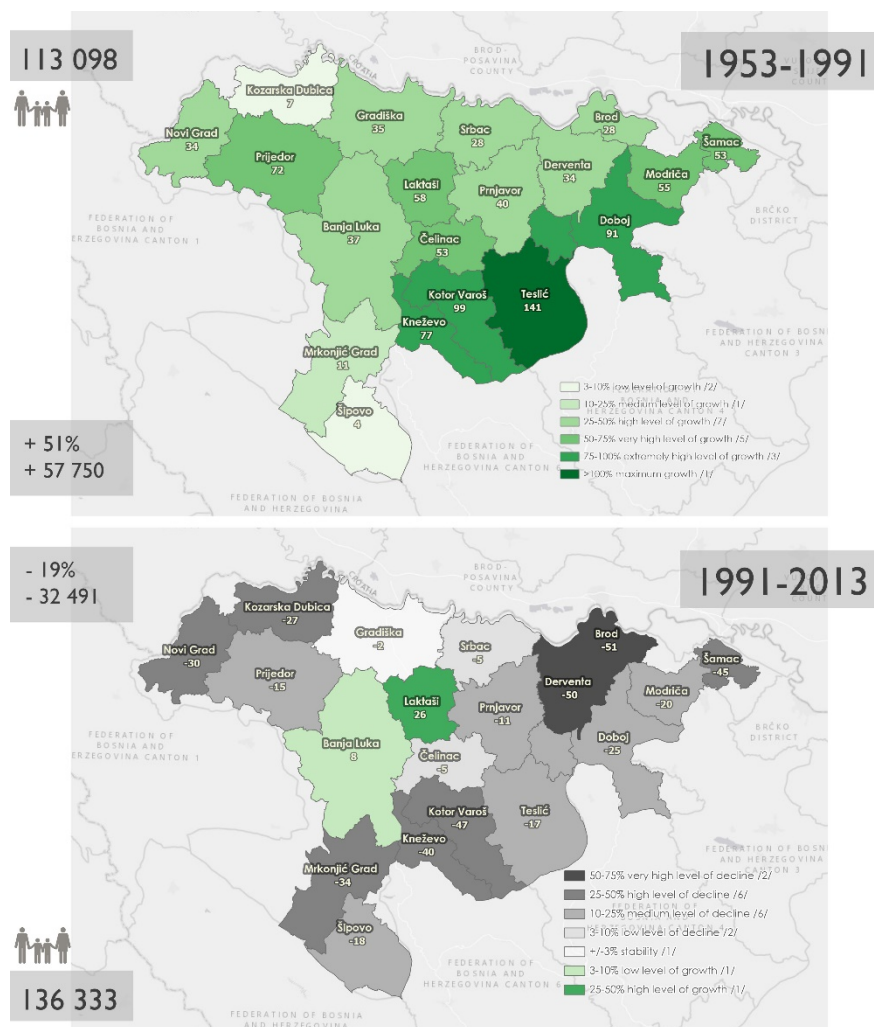

Figure 3. Growth and decline of number of households per villages of NW region of RS 1971-2013

3.3. DWELLINGS

Regarding the census statistics for dwellings, data are available for the census years 1971 and 1991, which are classified at the level of municipalities and settlements, as the lowest units of statistical analysis. For 1953, there are no records on the number of dwellings on either of these two levels, so it is not possible to consistently apply the proposed methodological approach. However, based on available data, an analysis and assessment of growth-decline trends for the 20-year period 1971-1991 was carried out, with the aim of gaining certain insights into the spatial dynamics of housing construction in rural areas in the pre-war period.

Concerning the trends in the number of dwellings, it is evident that in the period 1971-1991, all municipalities were in the phase of intensive housing construction, not only in urban but also in rural areas. During this period, all municipalities recorded an increase in the number of dwellings in rural areas. The villages of the region then received 49 069 new dwellings, i.e. an increase of 35% (Figure 4). Construction was dominant in the villages of Laktaši, Čelinac, Kotor Varoš and Šipovo, where the growth in the number of dwellings is over 50%. In the period 1991-2013, in 11 municipalities there was an increase in the number of dwellings, 7 municipalities have a pronounced decline, while one municipality has been moving within a stable framework. However, in the end, the region was richer by 15 619 dwellings in 2013, i.e. the number of dwellings increased by 8%. According to available statistics, it is concluded that the average number of tenants / persons per housing unit in rural areas of the NW region of the RS in 1971 was 4.8, in 1991 the number was 3.3, while in 2013 it was 1.9.

Given that the reference time frame for the analysis of pre-war dwellings is significantly shorter than the time frame used for the analysis of population and household movements (18 years shorter), it is obvious that there are discrepancies in the results and that certain indicators are significantly

lower. More precisely, it is not possible to produce direct analogies and comparisons, and to draw conclusions between different criteria.

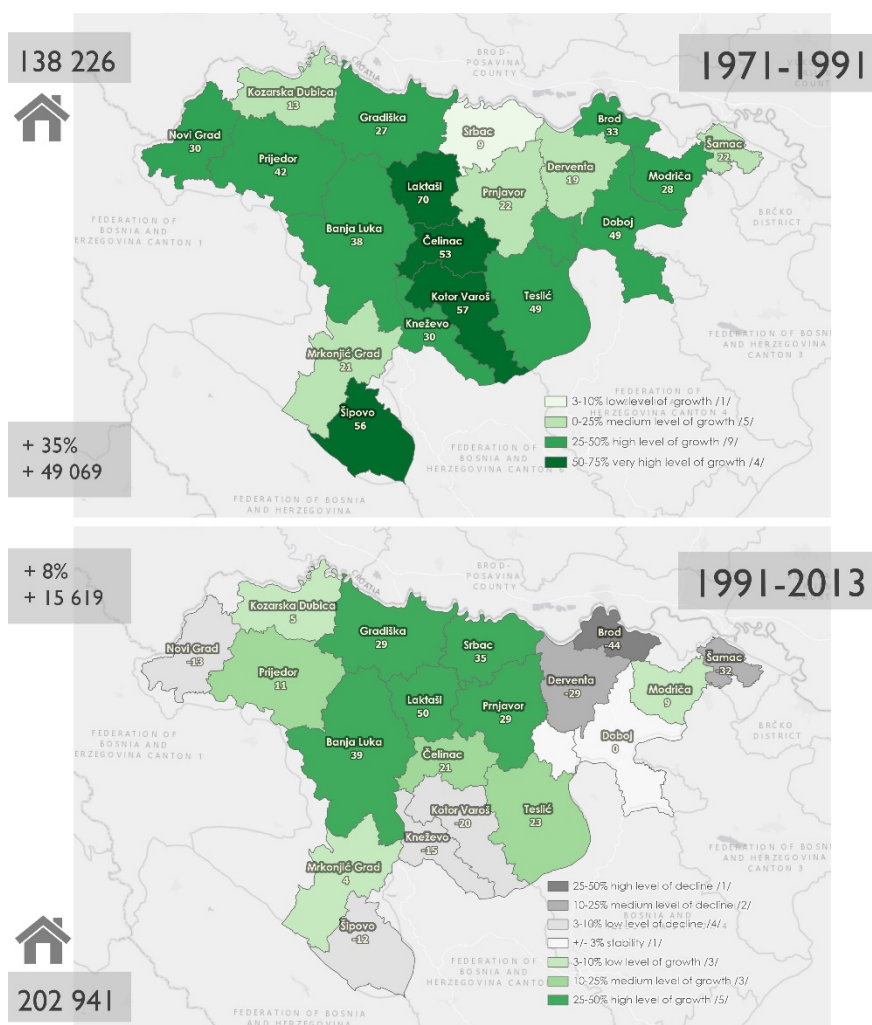

Figure 4. Growth and decline of number of dwellings per villages of NW region of RS 1971-2013

4. DISCUSSION

Based on the proposed methodological approach and the conducted analysis, key trends are summarised and the elements important for understanding of shrinking phenomenon in rural areas in the NW region of RS are underlined in the following. The conducted analysis of growth-decline trends in rural areas of the region shows two key patterns classified by periods: 1953-1991 and 1991-2013.

Although in the period 1953-1991 the total population of rural areas was within stable limits (+ 2%), the research findings show an uneven distribution of decline and growth in the region. Namely, 10 out of 19 municipalities recorded a decline in population in this period, in 8 municipalities the population grew, while in one it remained stable. At the same time, in all municipalities in the region there was an increase in the number of rural households (+ 51%) and dwellings (+ 35%). Intensive urbanisation and rural-urban migration are one of the key factors in population decline. In search of jobs and better living conditions, young people left rural households, went to cities and started separate families there. On the other hand, the splitting of large family communities also took place in the villages themselves, as indicated by data about the growth of the number of dwellings in rural areas of 35%. Furthermore, the fact that the average rural household in 1953 had 5.5 members, and in 1991 3.7 indicates trends in the division of households and justifies the growth of their number. The need for a separate life of the younger generations shows that, even then, the villages were slowly entering the second demographic transition [3]. This demographic dynamic has caused both, a decline in natural population growth and an aging rural population. In the context of housing construction, the question is: how the growth of the region's rural population of 2% (1953-1991) can

produce a 35% increase in the number of dwellings for a significantly shorter reference period (1971-1991)? The explanation for this can be found in the fact that the urban population still had strong ties with the rural hinterland, where they built cottages or summer houses, i.e. their second apartment. On the other hand, the division of large households while reducing the number of household members produces the need for more dwellings.

The civil war in Bosnia and Herzegovina in the period 1992-1995 represents a key tipping point in terms of demographic and spatial trends in the region and the most important factor due to which most municipalities in the region fell into a very difficult situation. Although it lasted only three years, the war produced enormous damage: death and displacement of a large number of people, downturn and destruction of a large number of economic enterprises, as well as devastation of the built environment. Research shows that in the period 1991-2013, the region lost a total of 281 261 inhabitants, of which 231 836 went to rural areas (Figure 2). This data shows that rural areas are radically affected by shrinkage than cities. Figure 1 shows that in this period, 18 out of the 19 municipalities in the region faced a decline in rural population. The war was followed by an attempt to recover, and the changes that took place led to a further decline in almost all areas of society. What marked the shrinkage after the war was: a decline in population growth rate, population aging, negative external migration trends and a decline in economic activity [8]. It is assumed that migration to developed western countries is one of the key causes of post-war stagnation not only in villages but also in cities. The exact number of persons who emigrated to other countries is not known, nor is it monitored by B&H institutions. The data about the number of emigrants from B&H are provided from migration statistics of host countries [8]. Nowadays the worrying trend is the relocation of entire families instead of previous, when only male members of the household went to work abroad. Such trends can radically affect the vitality of municipalities, cities and villages in the region, and lead to manifold negative consequences.

Although population decline is a key indicator of shrinkage, it is necessary to look at trends by the other two criteria. Namely, in the period 1991-2013, there was a radical decline in the number of rural households. More precisely, in 15 municipalities there was a decline, which for the overall region is 19%. The households further decreased, from 3.7 members in 1991 to 2.9 in 2013. This indicates the sequel of the second demographic transition which is manifested through: negative marriage rate, increased divorce rates, higher median marriage ages for both men and women, a higher average age of first childbirths, and a negative fertility rate [7]. Such trends ultimately produce a decline in natural population growth and an overall aging of an already small rural population.

However, regarding the number of dwellings in rural areas, an unexpected increase of 8% was recorded in the period 1991-2013. The question is, what produced this growth? In order to draw valid conclusions, it is necessary to conduct further research, related to the 2013 census statistics. Namely, the dwellings were only monitored in much more detail at the census 2013. In addition to the number, statistics classify dwellings by use, area, structure, year of construction, etc. [14]. Although data on dwellings are processed only at the municipal level, they can still be very indicative for understanding the dominant housing models, their spatial distribution, housing construction dynamics, housing standards, etc. The statistics on the number of empty dwellings, as well as holiday houses, are especially important for deepening the research. For example, statistics on the number of vacant dwellings show that in Republic of Srpska, out of 584 261 dwellings, a quarter (26%) are vacant (RZS-RS, 2017).

In order to understand the overall picture of stagnation of rural areas in the period 1991-2013, a typology of municipalities was created, which represents the synthesis of all three criteria (population, households, dwellings) and the classification of municipalities based on most significant differences. Although the typology focuses on stagnant patterns, the analysis does not exclude municipalities that are recording growth or remain within stable limits. Based on that, municipalities are typologically classified according to the following rules:

- Type A - municipalities with a decline in all three criteria
- Type B - municipalities with a decline in population and number of households
- Type C - municipalities that record only a decline in population
- Type D - municipalities in which growth was identified by all three criteria

The research findings show that in 7 municipalities there was a decline in all three criteria (type A), in 9 there was a decline in population and number of households (type B), 2 municipalities lost only the population (type C), while in one of them a growth in all criteria was identified (type D). The central municipalities of the region (Banja Luka, Gradiška and Laktaši) are the least affected by the shrinking processes, and as such they form the development axis of the region. On the other hand,

the peripheral municipalities of the region do not show such development patterns, on the contrary, they face a lower or higher decline and stagnation.

This extent of stagnation in the rural areas of the NW region of RS indicates the need for defining a clear point of view of local and national governing bodies in terms of mitigating the negative trends that arise as a result of the shrinkage. Also, the question is: how should planning respond to these negative changes and how should the community adequately manage them in the future? Is persistent advocacy of the growth paradigm justified in the shrinking conditions of the region?

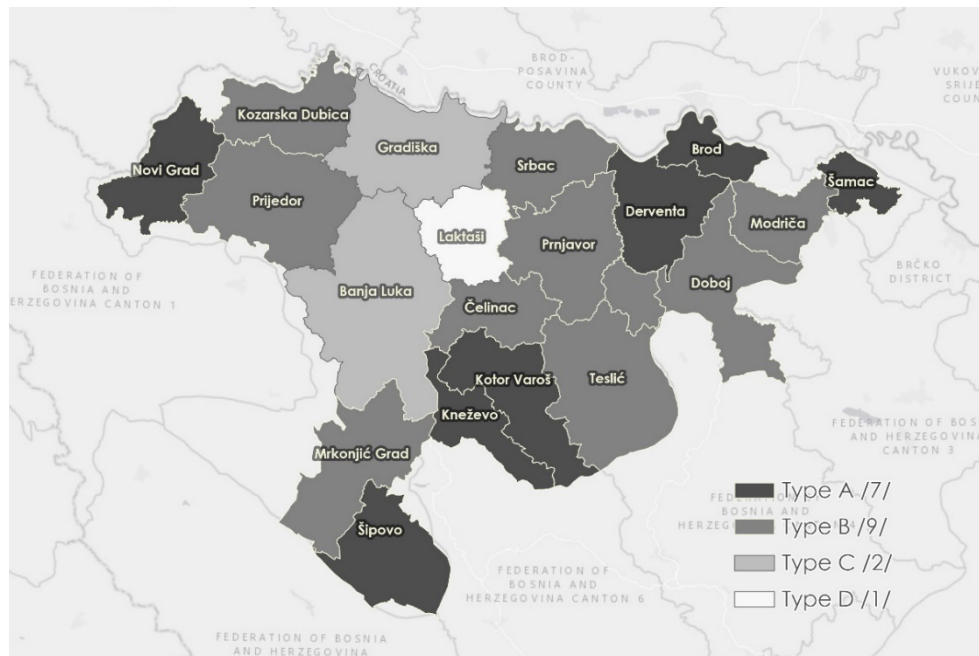

Figure 5. Typology of municipalities according to shrinking/growing trends in rural areas

In an attempt to partially answer these questions, the key issues are identified below and recommendations for further action are defined. Among the many problems, the following stand out:

- Insufficient awareness of national and local authorities, and planners about the problem, its scale and the damages produced in the local context/community.
- Preference of growth and development topics by authorities and planners, while ignoring the problem of shrinkage – if the perception of shrinkage does exist, responses of planning do not offer clear solutions to this problem.
- Insufficient research on shrinkage and impacts of such socio-economic changes in space - lack of information on the number of abandoned / vacant buildings and its characteristics.
- Insufficient public (national and local) instruments and tools for monitoring and managing these negative changes in space.
- Lack of housing policies both at the RS level and at the municipal level.

In order to react to the identified problems, it is necessary to raise the awareness first and foremost of political representatives, but also the scientific and professional community. Media exposure (TV, web, social network), professional seminars and professional-scientific conferences are just some of the ways to reach that goal. Only if these key actors truly accept shrinkage as the state we are in, is it possible to initiate management of negative changes. Such management should include: 1) identification and assessment of shrinkage across the region, 2) defining integrated and cross-sectoral planning solutions focused on solving problems caused by shrinkage (policies, strategies, programs, plans, projects, measures, activities), 3) implementation of planned activities, 4) monitoring and evaluation (M&E) of implemented activities and finally 5) adaptation of plans based on M&E feedbacks [8]. Planning and managing in such a system should be based on a communicative and collaborative approach that implies involvement and partnership among all stakeholders [15]. The model of continuous participation is a mechanism for learning by doing, where through negotiation and decision-making new knowledge is gained, perceptions and value systems are changed, approaches are corrected, i.e. overall knowledge is improved [16, 17, 8]. In this context, the involvement and role of the scientific community is especially important.

Experimenting in such a management system plays a significant role. Conducting experimental trials (e.g. pilot projects) enables rapid learning. Good practices are identified and developed, while bad ones are abandoned – one can learn from both of them.

5. CONCLUSION

Nowadays, many regions of the world are facing the problem of shrinkage, manifested through demographic decline, economic loss and dysfunction of the built stock. An increasing number of international and national studies show that the phenomenon is gaining a global character. However, although the topic of shrinkage is increasingly becoming a part of the international scientific agenda, its presence in the public, media and political agenda in Bosnia and Herzegovina is not enough. Political actors do not benefit from accepting shrinkage as an indicator of the state of the region and municipalities, which is why the topic of shrinkage is rather avoided. Yet it is undeniable that the problem exists and that its scale is significant.

The conducted research shows that the shrinkage is much more pronounced and rapid in rural areas of the northwestern region of RS than in urban areas. Namely, 18 out of 19 municipalities of the research polygon were affected by shrinkage (Figure 5). The results show that in the period 1991-2013 the total population of the region decreased by 281 261 inhabitants, where 82% (231 836) of this loss represent a decline in the rural population (Figure 2). The extent of the shrinkage of the village is best shown by the analogy according to which, the region in rural areas lost the population of almost 2 cities in size of today's Banja Luka (135 059) or 10 municipalities in size of Modriča (24 490) in this 22-year period.

Simultaneously, with the decline of the population in certain municipalities, there was a decline in the number of households and dwellings. Thus, in 9 municipalities, in addition to the decline in population, there was a decline in the number of households, and in 7 of them there was a simultaneous decline in all parameters (population, households and dwellings).

In the context of the applied methodology, it is necessary to point out that the research of shrinking phenomena in the spatial domain is limited, primarily due to insufficient development of the statistical apparatus in the field of collecting data on dwellings in pre-war census years. The methodology for collecting data on dwellings was significantly improved in the 2013 census, which opens the possibility for further research related to the number and distribution of vacant dwellings, as well as some other determinants relevant to the topic. The findings of such research can guide housing policies and future housing construction. Given that vacant dwellings make up a quarter of the total number of dwellings in the Republic of Srpska, and population movements show negative trends, the creation of housing policies at the national level is an imperative. Their development should be accompanied by local housing policies as strategic documents that guide future action in this area. In addition to the strategic approach, in the conditions of shrinkage, uncertainty, complexity and contradictions, it is especially important to develop various experimental programs, projects and measures that will enable changes at the operational level. Conducting such pilot projects enables learning about change, which ultimately should lead to management of shrinkage – uncertainty.

In addition to the shrinkage theory, developed by human geographers and demographers, which is in the focus of this research, a new *shrinking world theory* has simultaneously appeared with the development of information and communication technologies (ICT). The cross-linking of these two theories can be very useful for future research in the field of spatial development. According to Kirsch, “the popular conception of the world shrinking to a global village is generally seen as the product of technological advances in telecommunications, transportation, and information” [18, p. 529]. This time-space compression enables the relativisation of places, which can be a chance for villages to recover. Although globalisation in the economic domain has produced enormous damage and shrinkage at the local level [2], on the other hand it has produced new values in the ICT domain that villages need to take advantage of. The development of alternative housing (and work) models, based on the premises advocated by this theory, is a chance and possible path for regeneration of villages. Vujičić and Simonović see this recovery in the implementation of the so-called e-co model, which is a focused strategic approach based on the eco-friendly design and lifestyle, e-lance economy, and community cohesion [19]. Criticising the hectic urban lifestyle, they advocate a return to rural life, where the target group is the urban population of young, (IT) educated people who are dissatisfied with life in developed urban centres and who are looking for alternative lifestyles. In the context of such assumptions, further research on official statistics on information literacy of the population, the number, structure and distribution of employees in the ICT sector or other related sectors as well as data on the self-employed would be useful.

Uncertainty regarding the future demographic and spatial dynamics set new requirements for planners. Redefining of planning approaches is necessary if society seeks to achieve sustainability and resilience in both rural and urban areas. This implies a change of planning approach in which socio-spatial dynamics is not seen as a linear process of constant growth and prosperity of regions, but rather as a process of facing complex, multidimensional challenges of today, which increasingly imply stagnation and decline. Such planning will produce (positive) changes only if it is accompanied by effective management models not only of rural space but also of entire rural system.

LITERATURE

- [1] I. Turok and V. Mykhnenko, "The Trajectories of European Cities, 1960-2005." *Cities*, vol. 24, no. 3, pp. 165-182, 2007.
- [2] K. Pallagst, T. Wiechmann and C. Martinez-Fernandez, *Shrinking Cities International Perspectives and Policy Implications*, New York, London: Routledge, 2014.
- [3] D. J. Van de Kaa, "Europe's Second Demographic Transition." *Population Bulletin*, vol. 42, pp. 1-57, 1987.
- [4] KINESIS, "Knowledge Alliance for Social Innovation in Shrinking Villages." 2021. Internet: <http://www.kinesis-network.eu> [Apr. 28, 2022].
- [5] P. Oswalt and T. Rieniets, Eds., *Atlas of Shrinking Cities*, Ostfildern-Ruit: Hatje Cantz Verlag, 2006.
- [6] T. Wiechmann and M. Wolff, "Urban Shrinkage in a Spatial Perspective – Operationalization of Shrinking Cities in Europe 1990 – 2010." in *AESOP / ACSP 5th Joint Congress 2013 Planning for Resilient Cities and Regions*. Dublin, 2013.
- [7] T. M. Vujičić and A. Đukić, "Methodological framework for shrinking cities case study research: northwest region of Bosnia and Herzegovina." *Geodetski vestnik*, vol. 59 (3), pp. 520-536, 2015.
- [8] T. M. Vujičić, "Methodological framework of integral adaptive management for shrinking cities - case study Prijedor.", PhD thesis, Faculty of Architecture University of Belgrade, 2018.
- [9] ESPON – European Spatial Planning Observation Network, "Policy Brief: Shrinking rural regions in Europe." Internet: www.espon.eu/sites/default/files/attachments/ESPON%20Policy%20Brief%20on%20Shrinking%20Rural%20Regions.pdf, Oct. 23, 2017. [Apr. 28, 2022].
- [10] EEA - European Environmental Agency, "Urban morphological zones (UMZ) 2000." Internet: www.eea.europa.eu/data-and-maps/figures/urban-morphological-zones-umz-2000. 2009. [Aug. 6, 2017].
- [11] SZS-SFRJ, *Popis stanovništva i stanova 1971. Stanovništvo i domaćinstva u 1948,1953,1961 i 1971 i stanovi u 1971. Rezultati po opštinama i naseljima*, Beograd: Savezni zavod za statistiku SFRJ, 1975.
- [12] SRBH-RZS, *Popis stanovništva, domaćinstava, stanova i poljoprivrednih gazdinstava 1991. Prvi rezultati za stanovništvo, domaćinstva, stanove i poljoprivredna gazdinstva po opštinama i naseljenim mjestima*, Sarajevo: Republički zavod za statistiku Socijalističke republike Bosne i Hercegovine, 1991.
- [13] RZS-RS, *Popis stanovništva, domaćinstava i stanova u Republici Srpskoj 2013. Rezultati popisa: gradovi, opštine i naseljena mjesta*, Banja Luka: Republički zavod za statistiku Republike Srpske, 2017.
- [14] RZS-RS, *Popis stanovništva, domaćinstava i stanova u Republici Srpskoj 2013. godine - Stanovi i zgrade*, Banja Luka: Republički zavod za statistiku Republike Srpske, 2017.
- [15] P. Healey, *Collaborative planning: Shaping places in fragmented societies*, London: Macmillan, 1997.
- [16] B. Walker, C. S. Holling, S. R. Carpenter and A. Kinzig, "Resilience, Adaptability and Transformability in Social-ecological Systems." *Ecology and Society*, vol. 9(2): 5, 2004.
- [17] B. K. Williams and E. D. Brown, *Adaptive Management: The U.S. Department of the Interior Applications Guide*, Washington, DC.: Adaptive Management Working Group, U.S. Department of the Interior, 2012.
- [18] S. Kirsch, "The Incredible Shrinking World? Technology and the Production of Space." *Environment and Planning D*, vol. 13, no. 5, pp. 529-555, 1995.
- [19] T. M. Vujičić and D. Simonović, "Urban-Rural Synergy in Shrinking Regions Through Application of e-co Model." in *Handbook of research on urban-rural synergy development through housing, landscape, and tourism*, A. Krstić-Furundžić and A. Djukić, Eds., Hershey: IGI Global, 2019, pp. 335-360.

23

Research paper | Оригинални научни рад
DOI 10.7251/STP2215246M
ISSN 2566-4484



Anita Milaković, University of Banja Luka, anita.milakovic@aggf.unibl.org
Nevena Novaković, University of Banja Luka, nevena.novakovic@aggf.unibl.org

COLLECTIVE HOUSING FORM IN THE CONTEXT OF THE DISPERSED CITY: BANJA LUKA CASE STUDY

Abstract

The paper discusses how the dispersed urban form of Banja Luka (Bosnia and Herzegovina) is related to the collective housing form that emerged during the 20th and 21st centuries. The morphological study resulted in the typological patterns of collective housing form based on the relationship between the house and open space and follows its transformation during the period. It was based on a qualitative analysis of the figure/ground ratio and its configuration, and the correlation of morphology results to distinct economic issues and architectural paradigms. The research confirmed that open space was continually and significantly present in collective housing form in all typological patterns. The diffuseness and openness on the housing scale contributed to the dispersity of urban form on a larger scale.

Keywords: collective housing form, dispersed urban form, figure-ground, open space, Banja Luka

ФОРМА КОЛЕКТИВНОГ СТАНОВАЊА У КОНТЕКСТУ ФОРМЕ ДИСПЕРЗНОГ ГРАДА: СТУДИЈА СЛУЧАЈА БАЊА ЛУКА

Сажетак

Рад разматра везу између дисперзних карактеристика урбане форме Бања Луке и карактеристика форме колективног становања у току 20. и 21. вијека. Резултат морфолошке студије, презентоване у раду, су типолошки обрасци форме колективног становања чија је класификација заснована на релацији између куће и отвореног простора и прати њену трансформацију током предметног периода. Базира се на квалитативној анализи односа и конфигурације фигура/позадина и њихове корелације са одређеним економским параметрима и архитектонским парадигмама. Истраживање је потврдило да је отворени простор континуално присутан као структурални елемент форме колективног становања. Разуђеност и отвореност у размјери форме становања допријела је дисперзности урбане форме у великој размјери.

Кључне ријечи: форма колективног становања, дисперзна урбана форма, фигура-позадина, отворени простор, Бања Лука

1. INTRODUCTION: SCALES OF DISPERSED FORM

In contemporary urban theory, a compact urban form is considered sustainable. The generally accepted premise is that morphological features of compactness and density of built structures have positive ecological, economic and social effects on urban life [1], [2], [3]. The concept of a compact city is widely operationalised in urban policies and strategies [4]. In such compact and dense urban forms open spaces are planned as counterpoints to the built fabric. They are also compact, large and categorised as a specific typology - parks, green belts, boulevards, squares, etc. However, not all cities can become compact, and some have never been compact. On the contrary, urbanisation today produces a large, dispersed, and polymorphic urban tissue deeply extended in the once rural and natural environment [5], [6], [7]. Open spaces have a significant role in the composition of the dispersed urban form [8], [9] and observing them through traditional typologies of large compact voids in the dense built fabric is inadequate. The dispersed city also needs attention concerning urban policies and spatial regulations that follow its inherent nature.

The morphological case study presented in this paper aims to contribute to dispersed city considerations, its origin and the relation of dispersity to smaller spatial scales of urban form. Banja Luka, the case study city, has a dispersed and porous urban form generated through historical development and change (Figure 1) [10]. It is a middle-size city with recognisable spatial openness whose morphological logic needs to be understood at various scales and appropriately integrated into city planning and design. Residential architecture is considered a driving force of every city's production and growth. The research focuses on the collective housing form and its intrinsic relation between built and open space to understand the characteristics and qualities of dispersed urban form on a smaller scale. The initial research thesis is that open space was the intrinsic morphological element of the collective housing form. The open spaces were not only planned at the city scale as the reserve of undeveloped land or parks but were integral parts of residential architecture and culture through the 20th century.

This presumed long-pervading characteristic of urban form has changed in the past 20 years. The recent construction of collective housing has the minimum open space planned and integrated into the design. It is usually built on the plots with single-family housing, replacing their abundant open spaces with dense built form. At the same time, urban plans do not offer the traditional typology of compact open spaces, such as the new parks, in addition to the trend of building densification. Considering this transformation of collective housing form, the residential open space in the urban area is shrinking, and the culture of the common open space use is reduced. At the city scale, densification and reduction of residential open spaces changes the urban form and reduces its ecological resource.

The research aims to address these problems by studying continuity and change of morphological elements that could help understand the origin of urban form dispersion and inform the spatial regulation on both scales. The morphological relation between the scale of the building and the scale of the city become relevant in urban form theory in the 1960s. An influential book by Aldo Rossi puts *the typology of housing* at the core position of this question. Discussing the concept of the urban whole Rossi's theory emphasised the importance of the relation of a single building to city form [11]. The spatial elements and principles that constitute this relation should be seen through time and, therefore, the permanence and change. The approach was called *the architecture of the city*. Japanese architect Fumihiko Maki took the strategy further and suggested the design principles of collective form, starting with individual elements to arriving at a whole [12].

Contemporary morphological studies of urban housing are usually concerned with the characteristics of the house form and its typological transformation [13], [14], [15]. Consideration of open space as an element of the form is essential for establishing a relationship between the two scales in question and for understanding the dispersed character of urban form. Therefore, this qualitative research will present the types of collective housing form in Banja Luka based on the relationship between the house and open space and their transformation during the 20th and 21st centuries. It will analyse the figure-ground ratio and its configuration and discuss the incidence and quantity of open space as a contributor to the porosity and dispersion of urban form. This study intends to understand and highlight the continually present characteristics of collective housing form and enable the application of positive features of residential heritage in the planning and designing of the new phase of urban and residential culture.

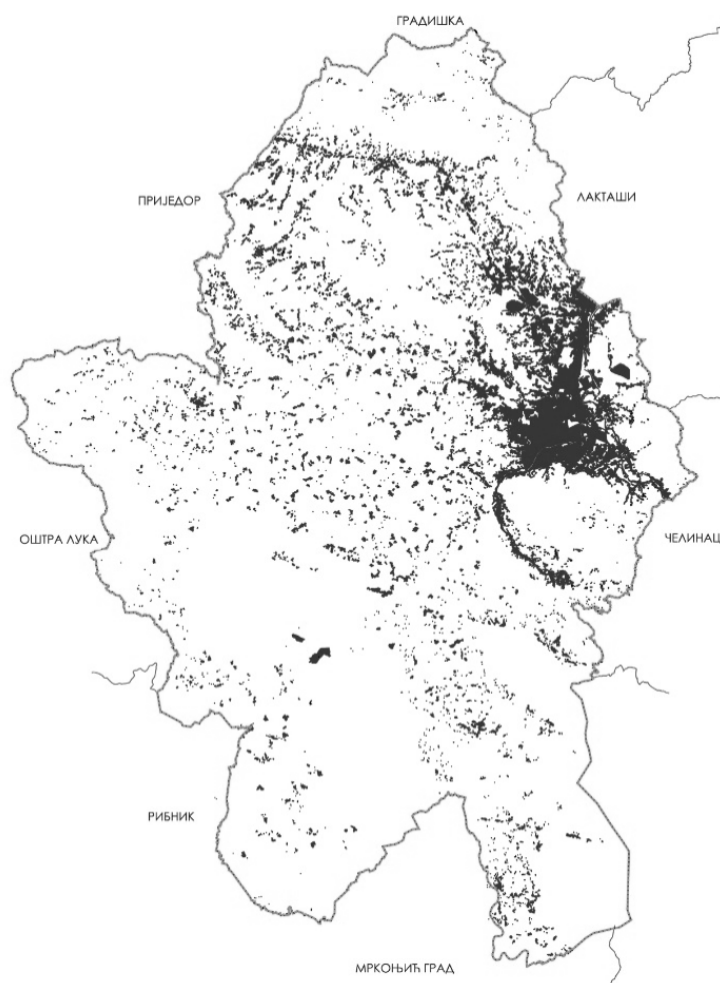

Figure 1. *Dispersed urban form of Banja Luka mapped inside city territory borders (map by students Biljana Petrović and Ivona Knežević)*

2. RESEARCH METHODOLOGY

The research on collective housing in Banja Luka is conducted as a morphological case study [16] based on the figure-ground ratio and its configuration. The reference scales for this study are the building and the block scale. The research is done in two steps. In the first step, we analysed figure-ground maps of Banja Luka and identified types of collective housing. The main criteria for typological classification were position of the building in relation to surrounding buildings - attached or detached volume, and the number of buildings that make the housing form - solitary volume or ensemble of volumes. The second research step describes each pattern through further figure-ground analysis (position of the building in relation to the street and plot coverage), context of building and process of formation (including their correlation to distinct economic issues and architectural paradigms). Context of building is observed through plot sizes (single plot, block, joining the few plots), land ownership, investment - who is building and for whom, what were trends in design - inherited (traditional type of residential living) and reflection on and application of general trends in housing design and culture of collective living coming from European context.

This research was based on several methods: a) figure-ground mapping of generic housing form and related open space as the representation and analysis tool; b) data collecting and content analysis of documents about collective housing in the 20th and 21st century, such as historical and contemporary maps, planning documents, photography, secondary literature; c) field survey as information update, primarily on collective housing from the recent period, included mapping and photography. The plot and building ownership was studied paradigmatically as the history of urban property, based on content analysis of spatial regulation documents, laws, and secondary literature. The analysis of the relation between the housing form and urban form at a larger scale was based on the map study from previous research results about the dispersed urban form of Banja Luka [10].

3. MORPHOLOGICAL STUDY OF COLLECTIVE HOUSING IN BANJA LUKA



Figure 2. *Figure-ground map of Banja Luka, segment.*

The two figure-ground maps (Figure 1, Figure 2) are showing the spatial openness and dispersed properties of Banja Luka's urban form. Many unbuilt spaces (voids) of different shapes and sizes are embedded in the form of the city 'urban area'. After recognizing the urban form of Banja Luka as dispersed on the city scale, analysis is conducted on the building and block scale observing the figure-ground ratio and spatial layout of collective housing. The first criteria identified through observation of figure-ground maps is building(s) layout. Buildings layout is described and classified through two characteristics: the position of the building in relation to surrounding buildings and the number of buildings that make the whole. From this, three collective housing types were defined: detached housing building, attached housing building, and ensemble.

3.1. DETACHED HOUSING BUILDING

Detached building type is the dominant form of individual housing in Banja Luka and it is present in collective housing, too. It consists of one freestanding building on a small plot, away from the street line and surrounded by an open space (Figure 3). The detached type follows the traditional logic of a single-family house that is compact in form and occupies a central position on the plot. Very often, fences have been set up around the plot. The fence has a territorial role in the domain of the use of open space and not ownership. The figure-ground ratio varies in different periods.

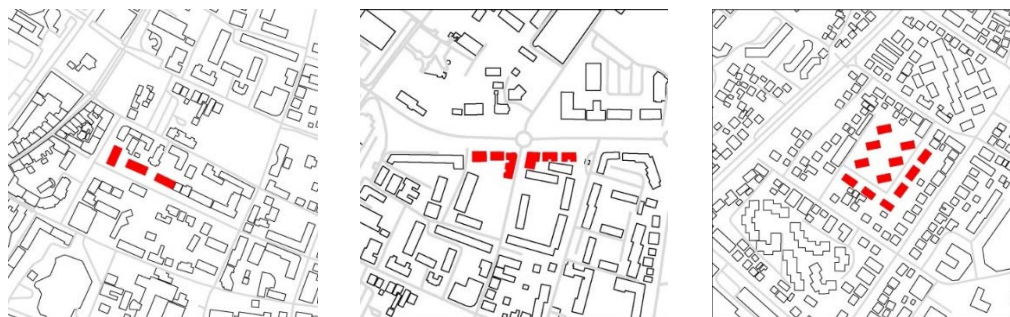

Figure 3. *Samples of detached housing buildings in Banja Luka*

Detached collective housing buildings were built in the 1930s when the ownership of land and buildings was private. Of course, in the period of private ownership of land and building for rent, the floor area of the building tends to occupy as large area of the plot as possible (Figure 3, drawing in the middle). At this time, wealthier citizens were investing in collective housing buildings. "Given that according to the law on ownership, individual ownership of the apartment was not possible (only houses or entire buildings could be owned) apartments in collective housing buildings were intended for rent.[18, pp.81]" People inhabiting those buildings were members of the ruling class and their higher bureaucracy. Architects educated in Europe bring the first influences of modernism

(smaller plot coverage, more light, and more sun). There is a visible tendency to clear the inside of the blocks and to create smaller green areas. Private investment must pay off so this brings the first signs of standardization and big plot coverage still plays an important role (even though it is smaller than at the beginning of the century). Plot coverage is up to 50% and that allows more light and sun and immediately slightly raises the quality of living [17, pp.10].

In the first years after World War II, there was a great need for housing construction, both due to the destroyed housing stock during the war and the migration of the population to urban centers. Given that the economic situation in society and the state was scarce, housing construction was not large-scale. Until the 60s, spatial changes and the construction of collective housing buildings are happening unassumingly, replacing a few old buildings or building on an empty plot. It is always a single building on small or medium-sized plots. These are individual buildings interpolated into city blocks and empty plots with direct access to the street. The position of the building is different from before World War II. They are detached buildings withdrawn from the street line forming the front yard. Through archival research, we identified some standardization elements. For example, two types of buildings were designed and constructed in several locations in Banja Luka (Figure 3, drawing on the left). One of them, was also built in another city in Bosnia and Herzegovina.

Detached building type is present also in today's housing construction. It is not the dominant type because there is an evident tendency to return to traditional blocks with attached buildings. Buildings are detached but with high plot coverage and positioned at minimal distances from the plot edges.

3.2. HOUSING ENSAMBLE

The ensemble is a type of collective housing form that contains large open spaces, continuously spreading between compact building forms. Intensive housing construction and the creation of a new housing culture in freestanding collective housing buildings, ensembles, or neighborhoods, will begin in the 1960s. Larger housing ensembles were built with unified, compact, and simple residential buildings. There was no clear relationship to the street line. The plot was not an important element in the formation of the building-void or figure-ground relationship. The block is now becoming a construction space. In some cases, the area of construction is a large part of the block (several plots are joined), or it is the whole block or even several blocks are made and new streets are also planned and designed. Collective housing ensembles were designed according to the principles of each composition and each ensemble has its internal logic (Figure 4). Ensembles were built in the central parts of the city and the periphery.



Figure 4. *Samples of collective housing ensembles in Banja Luka*

Preconditions for such housing forms are set by modernist principles of collective housing design and functional city planning, state ownership of land, and regulation of construction through planning, in contrast to the plot scale of construction and regulation in the previous period. Construction land now is state-owned. State institutions together with larger economic entities (again state-owned) invest in housing construction. The reason for intensifying housing construction was the same as in cities across Europe - the large shortage of housing. That was increased due to the consequences of the war and the intensive migration of the population. The migration of people from the countryside to the city in search of work, primarily in the industrial sector, will continue during the 1970s and 1980s. Their spatial and organizational complexity and size have grown over the decades, along with changing funding mechanisms and construction organization, strengthening the ideology of community, and developing an architectural culture. Two other factors especially influenced the activation of mass housing construction in Banja Luka: the establishment of the Institute for Urbanism Banja Luka and the transition of the largest construction company "Krajina" to the IMS prefabricated construction system.

One of the first residential ensembles built in Banja Luka was *Hanište* and its part *Crkvena*, built in the 60s. The ensemble consists of several simple multi-story buildings with an elongated rectangular base and four towers with twelve floors. The towers on *Hanište* are the first buildings of this type built in Banja Luka. The apartments in this neighborhood were constructed for the workers of the local factory. Next to *Hanište*, a much larger neighborhood of *Čaire* was built. The architect Nedžad Hotić, employed in the newly founded Institute for Urbanism Banja Luka, designed the ensemble that contains 17 collective housing buildings. The compositions of both ensembles are formed from elongated buildings with a rectangular base and a height of 4-8 floors, which are positioned in parallel or at right angles one to the other. Between the buildings, there is an open space divided into smaller green areas relatively close to residential buildings, except in the case of four residential towers that stand in two rows in the open space of the block. These collective neighborhoods introduce a new pattern of housing culture in the central part of the city, which involves the use of open spaces of a collective nature [19].

In 1975, the city of Banja Luka got its first major planning document – the Urban plan. The housing of higher densities (over 200 inhabitants/ha) appeared in the Plan. There was a tendency to limit this city function to a more compact zone, with higher densities and engaging smaller territory [20, pp.11]. In addition to the tendency to build housing ensembles of higher densities, there are evident morphological changes such as the development of more complex forms of housing ensembles. Since the end of the seventies, the focus has not only been on the minimum satisfaction of housing needs but also on a higher quality of living. After the necessity, we move on to create spatial conditions for housing of better quality. In that context, ensembles built in the 80s represent the "golden age" of the architecture of collective housing in Banja Luka. Both, the spatial arrangement of the buildings and the boundaries between the building and the open space become more complex (Figure 4, drawing on the left).

There are a few examples of housing ensembles built in Banja Luka in the last 30 years too. However, the figure-ground ratio of those ensembles is different from the ensembles of the 20th century. Differences are most visible in higher plot coverage and accordingly smaller open spaces.

3.3. ATTACHED HOUSING BUILDING

Opposite to the detached building type is the housing form of the attached building on the street line. This type contributed to higher building density, formation of the traditional urban block, and compactness of urban form. However, this type was rare and sporadically built in Banja Luka. As a European model of urban development and building regulation, it appeared at the end of the 19th century but failed to become a local model. One small segment of the city fabric constituted of this type is remain in Banja Luka. It is *Gospodska Street* in the city center (Figure 5, the drawing in the middle).

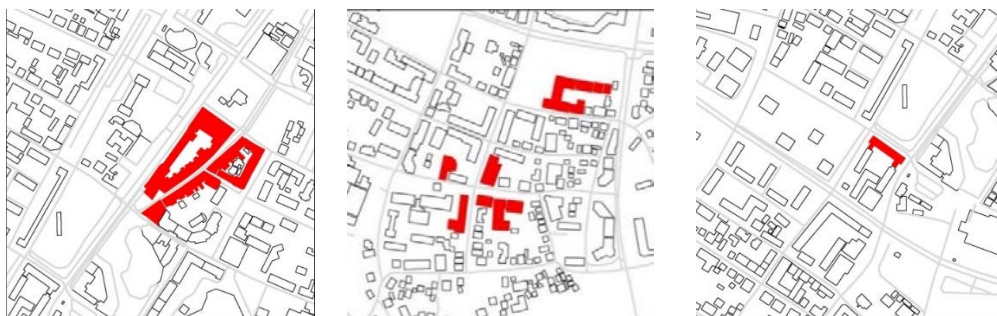

Figure 5. Samples of attached housing buildings in Banja Luka

At the turn of the 19th and 20th centuries, the rule of the Austro-Hungarian monarchy in Bosnia and Herzegovina brought with it numerous changes in all spheres of life. The oriental character of the culture of everyday life and urban structure and architecture has been replaced by the European pattern. More straight lines were introduced into the urban matrix and a new pattern of the mixed-use street appeared. Wealthier citizens, rich merchants, and artisans built residential buildings with more than one apartment. In the beginning, owners were living in the building and renting the rest of the apartments, after World War I those buildings were mainly built only for renting. Collective housing buildings were built on relatively small plots with plot coverage up to 95%. The building was attached and positioned on the street line and a lot of attention was given to the front facade design. Spatial arrangements were the same, but each facade was different from the others. This representational design and renting purpose led to the quite poor quality of living in those buildings.

Apartments in those buildings had little light and little sun. The courtyards were small and dark with no greenery [17].

After World War I, the construction of the attached housing type continues. The shapes and surfaces of each floor were various and depended on the size and shape of the plot. Until World War II, the buildings were up to three floors high [18, pp. 82]. Considering that the apartments were intended for rent, the space is rationally organized, the representativeness from the beginning of the 20th century is lost and the floor height is smaller and much more in human size (Figure 5, drawing on the right). At the end of the 1930s, apartment buildings were built in the narrowest part of the city and often had commercial spaces on the ground floor [18, pp.103-105].

The attached housing buildings were built also during the 1940s and 1950s, mainly in the city center. Although there was a change in land and building ownership after World War II, the housing form did not change significantly. It consists of longer buildings at the street line and smaller open spaces for service use inside the block. The same as the housing form from the Austro-Hungarian period, this variation of attached type is little represented in Banja Luka.

Attached housing buildings were also built at the end of the 1980s following the spirit of postmodernism. Since the 1990s, the individual plot is again the main construction site of collective housing. The plots are small-sized. An individual house's plot is being transformed into a space for a collective housing building of much larger dimensions. Sometimes, several smaller plots of individual housing are combined, so the collective housing building is built on a larger plot, but according to the concept of traditional European block Individual private investors are building collective housing buildings with apartments for sale. They are built one by one on small plots. The need for the investment to pay off in terms of space is shown in the aspiration for as many square meters of living space as possible. This leads to greater plot coverage and higher buildings (Figure 5, drawing in the middle). The houses are positioned on the street line and there is a visible tendency for continuity of street fronts. Streaming towards the traditional block is visible in urban space, but it is visible in planning documentation, too. Return to the traditional block is recognized as an optimal spatial response to the increase in housing density. Since the plots are small, the result is a reduction in residential open space with this more compact form of urban blocks. In most situations, this results in low quality of housing, so we return to the problems of the early twentieth century.

4. DISCUSSION: OPEN SPACE AS THE STRUCTURAL ELEMENT OF FORM

The detached housing type - compact building volume positioned centrally on the plot and distanced from the street line, was dominant in the first half of the 20th century. The origin of the detached housing type still needs to be studied. Its morphological characteristics are significantly different from the earliest urban housing in Banja Luka and Bosnia and Herzegovina. The single-family household groups - *mahala*, were the dominant residential environment from the 16th to the 19th century. The house in the *mahala* had separated volumes distributed on the plot. This configuration organised the residential space according to cultural patterns of dwelling - according to seasons, relations between hosts and guests, men and women, family and community [21][17]. This housing form comes from a specific entanglement of the oriental tradition of Ottoman rule and the local context. However, although the house form is fragmented, the households had an abundant open space, divided into a guest yard, a family yard, a garden and an orchard. These large and green open spaces in *mahala* produced a low population density, which did not exceed 80 inhabitants per hectare [17]. Therefore, the origin of the detached housing type could be searched in the influence of local rural housing and the European model of single-family housing transferred to Bosnia and Herzegovina after its annexation to the Austro-Hungarian monarchy.

In the second half of the 20th century, the detached houses were constructed in groups - ensembles. This collective housing type included larger open spaces and buildings compared to the previous period. It implied open space that continuously spread between compact building forms. Spatial and organisational complexity and size of ensembles have grown over the decades, along with changing funding mechanisms (state and workers' associations) and construction organisation (prefabrication), strengthening the ideology of community and developing an architectural culture. Ensembles were planned and built in the central city area in the first decade of their construction. In the more mature phase, construction is moving to the periphery, demanding more free space. The change of the collective housing scale brought the distinctive transformation of urban form as well. Formal and organisational autonomy of neighbourhoods as distinct urban units occurs only in the second half of the century. Precisely defined groups of collective residential buildings were incorporated into the existing small housing structure. Modernist superblocks are distinguishable by

their geometric clarity and large size and stand out compared to the housing volumes held together by the street matrix and land parcelling (Figure 6).

Open space was continually present in collective housing form during the 20th century. Furthermore, open space was not compact, but contrary, it was diffuse and almost uninterrupted by built structures. Its presence and diffuseness on the small scale contributed to the diffuseness of urban form on the city scale. It is logical to conclude that the openness of the collective housing form is the constitutive element of the urban identity of Banja Luka, which developed during the 20th century as a period of the most intensive growth of the city. Even in the first half of the 20th century, when the construction was on individual private plots and building by building, collective housing form have open space as a structural element. This openness was intensified with the transfer of land ownership to the state and the construction of large housing ensembles. Thus, the modernist principles of open composition represent an almost logical continuation of urban form evolution and not a contrast, as was the case with many European cities.



Figure 6. *Photograph of Banja Luka from 1978. Collective housing incorporated in existing small-scale housing structure [20]*

Dispersed urban form and airy image of the city resulted not just from architectural paradigms but from social and economic circumstances. Bosnia and Herzegovina were predominantly rural until the end of the 19th century. The European model of the compact city was not enthusiastically accepted when historical circumstances allowed its most direct influence at the beginning of the 20th century. There was no economic or social need for a compact city, usually developing from high population density and high land values. Bosnia and Herzegovina and Banja Luka had no phase of congested industrial cities of the 19th century. The detached housing type was transposed from single-family housing to collective housing form and then morphed into modernistic ensembles and neighbourhoods that overwhelmed urban territory. Several factors contributed to the dominant character of the openness of this housing form, beside the modernist principles of collective housing design and functional city planning. They are the state ownership of land and regulation of construction through planning, in contrast to the plot scale of construction and regulation in the previous period. Due to ownership, the land had a predominant use-value, not an economic one, and was available to planners without major restrictions.

The 21st century is characterised by the change of ownership of land and buildings to private one. The apartment becomes a market commodity for the first time. Collective housing is built on individual plots, and the choice of construction plots follows more the market availability and less functional organisation of the city. The result is an illegible and large architectural form that arises

from the pursuit of maximum plot coverage and its shape. These residential buildings and complexes can be unmistakably dated within the urban fabric only based on their massiveness and size. Open spaces do not have a structural role in this housing form but represent a minimal remnant of the undeveloped part of the plot intended for the necessary pedestrian access and parking. Therefore, the last several decades produced the new collective housing type which has the several characteristics of the three types recognised in the 20th century. It is represented by a large architectural form that lies in part on the street line, consisted of several connected volumes, and is detached from the objects in context. Contrary to the above three types, this collective housing form has the least open space.

5. CONCLUSION

Single-family housing was the dominant type of housing during the 20th century in Banja Luka and still is. It is certainly the main generator of dispersion of urban fabric concerning its low density and detached buildings. This research addressed the collective housing form that makes the other 40% of housing stock in Banja Luka to evaluate its morphological role in urban form. The research confirmed that open space was continually and significantly present in collective housing form in all typological patterns during the 20th century. It was not compact, but contrary, diffusely arranged around detached buildings. The diffuseness and openness on the small scale contributed to the dispersion of urban form on a larger scale. Therefore, the typologically described figure-ground configuration should be considered as a continually present component of the urban identity of Banja Luka, as it contributes to the continuance of the inherent urban structure.

The construction of collective housing in the recent period affects the inherited character of the urban form. The housing construction takes place on the scale of the plot, contrary to the large scale undertakings of socialist cities in the second half of the 20th century. The new housing form does not contain open space as a structural element but as a minimal functional component, and it makes a specific break in the morphologically open character of the city. The urban form is changing with a tendency towards building densification and compactness, since the new construction is taking place in previously undeveloped open space or comes in place of single-family housing, in both the urban center and periphery. At the same time, urban plans do not offer the traditional typology of compact open spaces, such as the new parks, in addition to the trend of building densification.

Urban planning should design its visions of urban growth rooted in the comprehension of dispersed urban form. More precisely, its potential and qualities come from the intertwining of built and open space. Otherwise, losing sight of open spaces as structural and compositional elements will not enable the comprehensive development of the territory. On the contrary, it could generate segregation and marginalisation. The human dimension of space is not only obtained through the small-scale design, but on the contrary, it largely depends on the simultaneous view of the city on a larger scale. If we consider open spaces as equally important structuring elements of dispersed urban form, just as built spaces, we might hope for the fresh urban visions of the environment where the culture and nature are in the new unity.

On the other side, the tools for managing urban growth should be associated with small spatial scales, as well. While understanding the contemporary economic and social context, it is necessary to look for new models of collective housing by focusing on the relation between built and open space in their form. This relation should be harmonised with the inherent morphological logic of the city in qualitative and quantitative terms. The new housing form could emerge with appropriate building codes which would accompany urban planning. Future morphological research on collective housing is important in this context. It can bring more detailed knowledge about inherited collective housing forms and local residential culture. The nature of morphological principles enables them to be easily translated into the necessary building codes [21]. Considering the figure/ground ratio and its configuration in collective housing form, the building codes will enable the preservation of the luxury of form openness and maintain the social, cultural and ecological values that open spaces bring to city life.

LITERATURE

- [1] S. E. Bibri, J. Krogstie, M. Kärrholm, "Compact city planning and development: Emerging practices and strategies for achieving the goals of sustainability," *Developments in the Built Environment*, vol. 4, 2020, <https://doi.org/10.1016/j.dibe.2020.100021>.

- [2] E. Burton, M. Jenks, K. Williams, Eds. *The Compact City. A Sustainable Urban Form?*. Routledge, 1996.
- [3] R. Burgess, M. Jenks, Eds. *Compact Cities. Sustainable Urban Forms for Developing Countries*. Routledge, 2000.
- [4] The Organisation for Economic Co-operation and Development, "Compact City Policies: A Comparative Assessment", 2012. [Online] Available: <https://www.oecd.org/regional/greening-cities-regions/compact-city.htm>
- [5] N. Brenner. *New Urban Spaces Urban Theory and the Scale Question*. New York: Oxford University Press, 2019.
- [6] N. Brenner, Ed. *Implisions/Explosions: Towards a Study of Planetary Urbanization*. Berlin: Jovis, 2013.
- [7] M. Topalović, "Architecture of territory. Beyond the limits of the city: research and design of urbanising territories." Inaugural lecture presented by Milica Topalovic on November 30, 2015 at the ETH Zurich. <https://doi.org/10.3929/ethz-a-010794553>.
- [8] P. Vigano, C. Arnsperger, E. Lanza, M. Martina and C. Cavalieri, "Rethinking Urban Form: Switzerland as a "Horizontal Metropolis," *Urban Planning*, vol. 2, pp. 88-99, 2017. doi: 10.17645/up.v2i1.871.
- [9] R. van der Velde and S. de Wit, "The Landscape Form of the Metropolis," *FOOTPRINT*, vol. 5, pp. 55-80, June 2009, <https://doi.org/10.7480/FOOTPRINT.3.2.709>.
- [10] N. Novaković, A. Milaković, D. Simonović, "Properties and qualities of dispersed urban fabric: understanding the Banja Luka urban form," in *International Conference on Urban Planning Proceedings*, P. Mitković, Ed., 2020, pp. 163-170.
- [11] A. Rosi, *Arhitektura grada*. Beograd: Građevinska knjiga, 2008, p. 53.
- [12] F. Maki, *Nurturing dreams. Collected essays on architecture and the city*. Cambridge: Massachusetts London: The MIT Press, 2008.
- [13] M. A. Hermida, N. Juca-Freire and J. P. Carvallo-Ochoa, "Urban tissues and residential types in Cuenca (Ecuador)," *Urban morphology*, vol. 24.1, 2020.
- [14] L. Alonso De Armiño Pérez, G. Vicente-Almazán Pérez De Petinto, VJ. Casañ Llopis, "Housing form and city form: Urban morphology and local identity," in *24th ISUF International Conference. Book of Papers*, 2018, pp. 779-790, <https://doi.org/10.4995/ISUF2017.2017.5772>.
- [15] G. Ledent and S. Komossa, "Referential types as clues for housing design," *Urban Morphology*, vol. 23, no. 2, 2019, pp. 125-142.
- [16] B. Case Scheer, "Urban Morphology as a Research Method," in *Planning Knowledge and Research*, J.W. Sanchez, Ed., Routledge, 2018, pp. 167-181.
- [17] J. Finci, *Razvoj dispozicije i funkcije u stambenoj kulturi Sarajeva*. Sarajevo: Zavod za stambenu izgradnju NR Bosne i Hercegovine, 1962.
- [18] S. Cvijić, *Moderna stambena arhitektura Banjaluka 1929-1941*. Beograd: Zadužbina Andrejević, 2014.
- [19] N. Novaković, *Research into patterns of use of public open spaces for the purpose of neighbourhood regeneration: a case study of the city of Banjaluka (Doctoral dissertation)*. University of Belgrade - Faculty of Architecture, 2014.
- [20] V. Stošić, Z. S. Mačkić, *Banjaluka koje ima i koje nema u 1000 slika*. Mega multimedija, digitalno izdanje, 2004.
- [21] B. Scheer and D. Scheer, "Typology and Urban Design Guidelines: Preserving
- [22] the City without Dictating Design," in *Nineteenth Century Urban Morphology*, Aga Khan Series, A. Petruccioli Ed., Cambridge, MA., 1998.



Dijana Simonović, University of Banja Luka, dijanaurb@gmail.com

NEIDHARDT'S VERNACULAR-MODERNIST GLOSSARY OF BOSNIA AND HERZEGOVINA'S ARCHITECTURE AND URBANISM

Abstract

The construction principles underlying Bosnia and Herzegovina's traditional building and the characteristics of its modernist architecture provide a basis for a set of criteria to evaluate its modernist heritage. The architect and town planner Juraj Neidhardt created a modernist-vernacular glossary of Bosnian-Herzegovinian architecture and town planning, with new terms based on analogies with concepts and spatial elements used in the past. Neidhardt's modernism has regional characteristics and is the earliest representation of critical regionalism in Bosnia and Herzegovina in the 1970s. There is a real need to reconsider and conceptualise alternative approaches to the process of revaluation of the entire material heritage of the Bosnian-Herzegovinian modernist era.

Keywords: Neidhardt's modernism, principles, regionalism, vernacular Bosnian architecture.

НАЈДХАРТОВ ТРАДИЦИОНАЛНО-МОДЕРНИСТИЧКИ РЕЧНИК БОСАНСКО-ХЕРЦЕГОВАЧКЕ АРХИТЕКТУРЕ И УРБАНИЗМА

Сажетак

Принципи грађења на којима почива архитектонско наслеђе Босне и Херцеговине и квалитети њене модерничке архитектуре могу бити основа за сет критеријума за валоризацију њеног модерничког наслеђа. Архитекта Јурај Најдхарт креирао је „модерничко-вернакуларни речник босанскохерцеговачке архитектуре и урбанизма“, на аналогји са концептима и просторним елементима из прошлости. Најдхартов модернизам са одликама регионализма види се као најранија репрезентација критичког регионализма у БиХ, 1970-тих. Неопходно је преиспитивање и концептуализација алтернативних приступа процесу ревалоризације материјалне баштине босанскохерцеговачке епохе модернизма.

Кључне ријечи: Најдхартов модернизам, принципи, регионализам, вернакуларна архитектура.

1. INTRODUCTION

In the mid-20th century, the modernist architect Juraj Neidhardt created a 'modern-day glossary of architecture and town planning – an alphabet of the patchwork town', a series of lace-like visual elements taken from his own architectural and town planning designs, which he used to formulate and explain these new terms based on analogies with concepts and spatial elements from the past. He also compiled a list of rules of thumb, which he formulated and presented in visual form, and which he claimed to have been used in Bosnia to build settlements during the long prevalence of Oriental architecture, such as architecture on the human scale, domiforms and cubiforms, texture-structure, houses with no furniture, growing houses, spatial architecture, nature connectedness, the right of view and the building process, as well as neighbourliness, 'never going against the grain', etc. Also meriting a mention are the creative syntagms and adages he coined, like 'geography of architecture', 'carpet city', 'green city', 'amphitheatre city', 'water as the soul of the city', 'sanctity of ambiance', etc. [1].

Together with architect Dušan Grabrijan, Neidhardt explored the characteristics of Bosnia and Herzegovina's building heritage, looking for the universal in its architecture and town planning. In 1957, they published their observations and conclusions in the book *Architecture of Bosnia and the Way to Modernity (Arhitektura Bosne i put u savremeno)* [2]. Among other things, the book contains a study of the urban physiognomies of Bosanski Brod, Zenica, Mostar and Trebinje, four Bosnian-Herzegovinian cities located along the axis connecting the Posavina (the Sava River Basin) with the Mediterranean. Based on this study, they framed new written principles for selected places and the 'backbone' of Bosnia and Herzegovina, the Posavina-Mediterranean industrial axis. Following the publication of the book, other regions of the former Yugoslavia were investigated to propose axes or directions intended to solve problems of spatial development that were 'complex in a regionally specific way', which could help today to identify and analyse comprehensively trends of urbanisation in Bosnia and Herzegovina and the former Yugoslavia.

Neidhardt was born to a Zagreb-based German family in 1901. He trained as an architect at the academy in Vienna under Professor Peter Berens, one of the most influential modern architects of the first generation. Following graduation, he went to work at Berens' Berlin studio (1930-1932), after which he left for Paris in 1933 and joined the studio of the famous Le Corbusier (1933-1935). During that period, he competed relentlessly with his designs and worked on a great many town planning and architectural projects realised across Europe. Le Corbusier asked him to join his team working on the Brasilia project, but Neidhardt returned to Yugoslavia instead. After spending a year and a half in Belgrade (from 1936), in 1938 he moved to Sarajevo, which fascinated him so much that he spent the rest of his life there. He died in 1979 [3].

2. NEIDHARDT'S PATTERN LANGUAGE: BETWEEN TRADITIONAL PLACEMAKING AND MODERNIST ARCHITECTURE AND TOWN PLANNING

Neidhardt compiled a modernist architecture and town planning glossary by coining new terms for spatial elements, which he did by drawing an analogy between the construction elements he used in his projects and those of traditional building, which had originated in the past. He incorporated in them the universal principles and unwritten rules of vernacular building, and as he formulated them, he also represented them in unique visual form. He claimed that they had been used to build settlements in Bosnia during the long period under Ottoman rule, with the Oriental style as the dominant one, as well as under Austrian-Hungarian administration, representative of a peculiar 'regionalist' way of placemaking and town plan regulation.

These principles were an expression of customary law and represented a kind of codex – a set of rules pertinent to different aspects of social life, which had been observed locally for a long time. The most important of those rules were the right of view (vista), the right of way and free access to common goods and amenities, and the inviolability of private property. The right of view, i.e., one's entitlement to a view (vista), was a unique building principle that had its origins in customary law and communal ethics, since it was a standard that ensured the provision of high-quality housing. In Julian of Ascalon's Treatise of Construction and Design Rules (6th c. A.D.; Julian was a Byzantine architect, originally from the Palestinian coastal town of Ascalon), this rule is called 'protection of the view'. The rule stipulated the preservation of direct views of the sea and harbor, with specific guidelines relative to three different categories of view, the foreground, which pertained to the coast, the harbour and docked ships, or the middle ground, and the background [4].

Neidhardt built his pattern language upon the universal principles he discovered in Bosnia's vernacular architecture. He concluded 'vistas and the right of view' were an important standard as it allowed every inhabitant of every town to enjoy a view from their home (Figure 1).



Figure 1. Neidhardt's visual representation of 'vistas and the right of view'

He also adopted the Bosnian traditional principles of layout of the mahala and typical household in it, thus respecting the country's unwritten building rules and codes. When planning the development of an urban area, he respected the right of view, choosing to position structures in such a way that those tall (open) ones stayed in the valley, those medium-sized (semi-closed) were on mild slopes or hillsides, and the low (closed) ones on steep slopes (Figure 2).



Figure 2. Settlement at Ilijaš (1940) built in accordance with the principle that 'each house should command an unobstructed view'

Neidhardt's arrangement of structures into three separate categories is clearly visible, as he strove to re-introduce to the so-called Bosnian town planning the traditional layout and to keep volumes in proportion to man. In planning Ilijaš, Neidhardt employed the principle that had previously governed the layout of towns (residential areas, or mahale, and commercial districts, or charshiye), with mahale winding down slopes and the charshiya, or the commercial centre of town, placed along the riverbanks in the valley (Figure 3). The architecture of his buildings, both residential and commercial, is modernist, but obviously drawing on Bosnia and Herzegovina's traditional settlement architecture.



Figure 3. 'Mahala', a small residential neighbourhood on the slopes above Ilijaš, with 'Charshiya', or the commercial district, located in the valley

The second principle emphasised by Neidhardt was that of 'neighborliness', an ethical principle or standard that had influenced the formation of oriental architecture (Figure 3). Neidhardt says that 'wherever possible, straight rows of houses are avoided. While the pattern of the mahala is meander-like, the charshiya is straight and densely built (Figure 4). Construction land must be used economically, whence the tradition of laying out buildings in charshiya in rows [2].



Figure 4. 'Neighborliness' as an ethical principle that had influenced the making of architecture

In addition, Neidhardt wrote about Sarajevo's oriental architecture and its dainty houses set amidst gardens as 'human-scale'. He described them as low-lying, horizontal and unpretentious, extending in layers over contiguous slopes, their rooflines interrupted only by minarets and poplar-trees. He saw the panorama as marvelously harmonious, calm, and all-embracing – the very image of an old civilisation. Referring to this, he reiterated that overall, the urban landscape appeared as a unique higher form, which he concluded was a result of local people's nature connectedness [2].

Third, claiming that every epoch has its own architectural glossary, Neidhardt used the 'alphabet of the carpet town' to put together his very peculiar building vocabulary – a visual representation of the transposition of traditional building patterns into modernist architectural elements, systems and principles, as used in his own projects (Figure 5).



Figure 5. Alphabet of the carpet town [2:324]

There are concrete examples which expose the postulates, elements and systems Neidhardt borrowed from vernacular architecture and which show how he translated, transformed and put them to use. For instance, the building of the Technical Faculty in Sarajevo is designed as a pavilion characterised by zigzags; the Gallery is a structure with an atrium; and in the case of the Ski Lodge on Mount Trebević, what is obvious is Neidhardt's appreciation of the traditional principle of the right of view, with its space organised to take into account the human scale, in wood and stone used the way these building materials were traditionally locally combined. In the case of the hotel project, he applied the ancient rule of 'receding houses', and in order to ensure the right of view, he terraced the structure. In the case of the Bachelor House in Zenica, he also took into account the rules of thumb by which traditional houses were laid out, but putting several flats under one roof.

Neidhardt compiled a glossary of terms and abbreviations that are essentially a codebook of the fundamental notions and ideas of single architectonic and urban realisations from the period between 1932 and 1956. 'Each of these abbreviations indicates an idea, a point of view, a law (principle, characteristic, composition, unwritten law etc.), varying according to the kind of subject. If a better explanation of a single project has to be found, it is not sufficient to name the same symbolically (e.g. carpet town, ship town, etc.), yet it is necessary to explain it by means of analogy (e.g. old – new, composition – agglomeration, etc.) or on the basis of a contrast (e.g. cupola – balcony, nucleus – heart, etc.). When we have to deal with more of such principles simultaneously, the abbreviations are enumerated as numbers in a mathematical formula. A collection of these abbreviations gives us as result the informative basis of the project' [2: 330]. The Ski Lodge on Mount Trebević may serve as an illustration: ODP + PNV + UP + RE + KAO + LK + DT + JS + KKO + SP = IP (informative or ideal basis). Within this frame the quoted formula reads as follows: ODP, PNV and UP – written laws according to which the object is composed in nature, RE – object purpose, KAO – functional

tripartite structure, LK – symbolic characteristics of the object, DT – dualistic position of the object, KKO – design system, JS – one-flight staircase, SP – surface working, etc [2: 330].

The above illustration of Neidhardt's methodological framework and tools clearly shows the exceptional logic and systematicity behind his intertwining of traditional and modern architecture. In his own words, an architectural tradition that grew out of people's centuries-old building experience and boasts unbroken continuity, which is then enriched with modern technical aspirations, can only be seen as organic. Although his designs are primarily modernist, they are also organic, as they appreciate tradition and rules of design and construction that grew out of experience. As a modernist, he realised and was fully aware of the advantages of using concrete to build the doksat, an Oriental-type enclosed balcony very similar to oriel windows and other cantilevered elements or units, which he used in combination with traditional materials, such as stone and wood. Also, he raised his buildings above the ground by propping them on pillars, thus connecting vernacular architecture with modern architecture.

3. NEIDHARDT'S APPROACH TO ARCHITECTURAL AND TOWN PLANNING AND DESIGN: PRINCIPLES AND METHODS

Neidhardt's urban and architectural discourse is grounded in the concept of 'landscape'. It is in the vein of modernism, yet articulated in the spirit of the regional and expressed as contextual design of planned settlements and organic architecture of designed buildings. Owing to Jelica Karlić-Kapetanović and her study Juraj Neidhardt – Life and Work (Juraj Neidhardt. Život i djelo) [3], one can speak with certainty about the key principles of Neidhardt's urban and architectural discourse.

Le Corbusier's discourse of urban landscape – le paysage urbain – was the theoretical cornerstone of all major precepts of urban landscape procedures and practices in the post-WWII Yugoslavia. They developed through the efforts of Yugoslavian urban planners to rise to the challenges of the profession in rebuilding war-torn villages and towns, as well as in planning new ones in a way that would reflect Yugoslavia's socialist society. They were mainly based on the overlapping of ideas and aspirations towards a classless society, and those of a better life for all social orders, as inherent in modernism. Having worked with Le Corbusier on the urban plans of Antwerpen, Stockholm, Algiers and Nemours [8:22], all of which had the urban concept of the 'Radiant City' (La Ville Radieuse) at their heart, Neidhardt built his experiences into his authentic approach to the urbanisation of Yugoslavian cities, bringing with him the latest European trends. He also introduced a key new way of urban thinking, rejecting the conventional method of two-dimensional urban drawing. He thought about cities from the standpoint of plasticity, that is, to him the city was a plastic phenomenon. In his own words, this aspect is especially focused on through close observation and analysis of cities in search for analogies between their identity and modern-day solutions, whereby they develop a new character and new plasticity. Neidhardt's entry to the Regulatory Plan of Novi Sad competition in 1937 contains a photomontage of the main city square, with a new boulevard going from it (Figure 6); it is a perfect illustration of his working principle, as interpreted by Dušan Grabrijan in his 'visual-analytical presentation of the plan': 'Cities should be sculpted. A well-sculpted city automatically answers all technical questions. Town planning is a synthesis, the sum of all the needs of a city representing one plastic whole...' [5:22].



Figure 6. *Regulatory Plan of Novi Sad: a photomontage of the main square with a new boulevard going from it*

Starting just before the outbreak of World War II and continuing in post-war Sarajevo and Bosnia and Herzegovina, Juraj Neidhardt and Dušan Grabrijan, similar to what Nikola Dobrović did in Belgrade, searched relentlessly for universal building tenets, as hidden in Yugoslavia's architectural and urban heritage. This is how they described their work in circumstances that meant a clean break with all tradition, including that of building: 'It was a period of struggle, of choosing between large streets with transit and corridor streets, quads and open neighbourhoods, authentic and colonial architecture, etc. Firmly believing that people only begin to live their lives once they are culturally

and politically free and independent, we thought the only path to creative contemporary architecture was through heritage. Therefore, we set out to discover architectural and urban heritage laws.’ [2:499] Understanding the importance of these principles or laws – spatial, functional, aesthetic and ethical (today also environmental), as laid down in the past, led the two architects to establish a special creative and analytical procedure. It was a highly peculiar and authentic approach, although it definitely relied on the modernist paradigm and urban discourse of the International Congress of Modern Architecture (CIAM) and Le Corbusier.

For Neidhardt, the functionalism as set by the CIAM was implicit, but he arranged functions across a site or place in response to its spirit, the experience of use patterns as defined in the course of its urban development, and the quality of the principal environmental conditions (insolation, ventilation, vegetation and prevention of pollution). Neidhardt combined a sophisticated understanding of and respect for natural givens, inherent qualities and standards of a particular area to create a kind of ‘regionalism’, which was not an administrative and political construct, but was understood as contextualism. In his approach he did not simply copy the past or engage in formalistic reminiscences, but he applied studiously and developed further what was perceived as natural standards or laws, and where a concrete place had previously been settled in and was inhabited, he also used man-formulated laws, adapted to the new needs of the inhabitants living in the new era.

These characteristics of Neidhardt’s approach are clearly seen in most of his plans and projects, such as the Iliđža Spa Urban Planning Project (1937/38), the worker and clerk neighbourhoods of Breza, Ilijaš, Pobrežje and Ričica (1939), the Zenica Town Planning Project (1940), and the urban planning projects of the miner communities of Vareš-Majdan and Ljubija (1941), had mostly been realised, but were partly destroyed in the 1990s civil wars. Also, the unrealised Iliđža Spa Urban Planning Project (which he worked on while at the Central Hygienic Institute in Belgrade, between 1 June 1937 and 31 October 1938) and the regulatory plans and projects that have been materialised – the worker settlement in Pobrežje near Zenica and the blue and white-collar neighbourhood of Ilijaš near Sarajevo – are highly illustrative of how uniquely creative Neidhardt as an urban planner was in his deliberations, as well as of his new concept of the urban landscape of Bosnian-Herzegovinian communities.

Neidhardt’s conceptual ideas to connect the green structure of the hilly hinterland of cities with the valleys they lay in, by allowing it to penetrate the urban tissue transversely, as had ‘traditionally been done in Sarajevo’ (Figure 7), show again how much importance he attached to the concept of ‘landscape’ in his urban discourse.

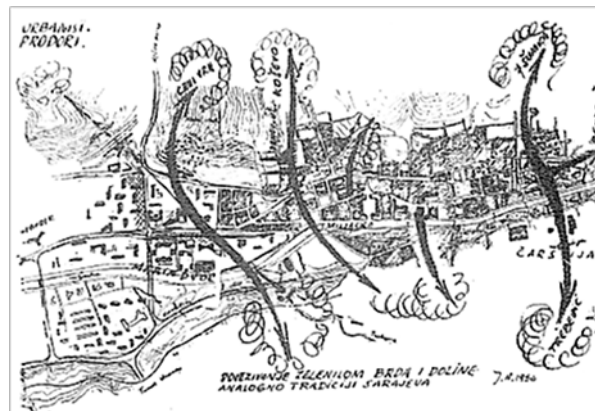

Figure 7. Schematic of Sarajevo as blending with green patches descending from the surrounding area

He believed it crucial to specify that which set each of these places apart – a criterion, a module, a lifestyle – which corresponded best to them individually and could be instrumental in identifying the most promptly those factors that influenced the decision-making processes concerning them. Close attention should be paid to the heritage value of Bosnia and Herzegovina’s abandoned and derelict modernist residential neighbourhoods and tourist resorts. The morphological diversity of these buildings and complexes also merits special attention. They are characterised by common (collective) patterns of use of space, resulting from an aspiration toward a ‘just policy of communal life’, one that would strike a balance between common and individual interests, as well as between public and private ownership, i.e., that would lead to a synthesis of the individual and the communal, and also resulting from collectivist values, as disputed nowadays, and seeing architecture in the wider context of socio-political and economic conditions, as Neidhardt saw it [6:227].

Neidhardt's urban plans and projects of blue and white-collar neighbourhoods across Bosnia and Herzegovina (1939-1945) were based on the above premises, nonetheless with a special approach adopted for each one of them. He planned the future of these neighbourhoods or settlements according to modern principles of organisation of civic and collective life, shaping them to newly created values and lifestyles as well as those inherited, to building traditions and to social relations. He took into account all layers of meaning as present in a given area or place and incorporated into his solutions assumptions about the inhabitants' cultural needs, which were rather forward for the period – their social needs, housing needs, the need to have places of worship, libraries, schools, health facilities – complete with green areas positioned around industrial complexes to be used for exercise and recreation [3:110]. The residential architecture of those neighbourhoods and settlements was morphologically diverse and included houses containing different types of workers' dwelling units or flats, which he also nicknamed to convey the number of the units contained; e.g., houses with two flats were called 'twins', craftsmen's homes with four flats – 'quads', single-family houses – 'clerk homes', as well as 'quintuplets', 'sextuplets', etc. [6:37].

3.1 SPECIFICS OF NEIDHARDT'S METHODOLOGICAL APPROACH

Neidhardt explained the nature of his urban discourse and his understanding of urban landscape in the previously quoted *Architecture of Bosnia and the Way to Modernity*, in the chapter titled 'Four Cities – Four Physiognomies', demonstrating the universality and comprehensiveness of his methodological approach in solving the problems of planning four selected Bosnian-Herzegovinian cities – Bosanski Brod, Zenica, Mostar and Trebinje – located along the axis cutting through Bosnia and Herzegovina and connecting Posavina with the Mediterranean.

Starting from the fact that the same problems arise in all places in Bosnia and Herzegovina, with only the climate, vegetation, customs and urban criteria or principles by which a place was built being different, he considered it important to discover the laws which had governed the birth and construction of anyone place originally and to draw conclusions accordingly about how to build new units and places. He concluded that many of the unwritten laws and ethical principles he discovered in connection with Sarajevo's development were also visible in other places in similar environments. However, the most important thing was to formulate, in a broader sense, new written laws for concrete places and the 'backbone' of Bosnia. 'Some of these principles can be easily implemented in the case of our modern places without much ado; such are the green city, the carpet city, water as the soul of the city, neighbourliness, the right of view, the human scale, etc.' The analysis of this study shows his broad – i.e. regional – approach to spatial planning, as mentioned elsewhere in this paper. It is evident in his insistence on the importance of dealing similarly with regions of the former Yugoslavia, by profiling them and finding their 'axes', on the basis of which spatial development problems could be solved in a 'complex' – regional – manner [2: 452].

Neidhardt studied the concept underlying the morphology of the towns lying along the regional axis running from Slavonski and Bosanski Brod ('a town next to a town'), across Bosnia and Herzegovina, all the way to the Adriatic. Recognising in it an industrial 'axis' or belt, he compared the principles on which they had developed, drew lessons from it and made decisions about new urban concepts to develop these places. Since all the towns were lowland and had corresponding physiognomies, Neidhardt used a unitary approach to planning Slavonski Brod and Bosanski Brod, two towns on the opposite banks of the Sava River, treating them as an organic whole comprising two administratively distinct units. The key element of his design is the diagonal street plan – which shortened the distance between the neighbourhoods – laid out as a garden city with small residential areas, composed of urban cores or blocks (neighbourhoods) (groups of residential buildings) complete with schools, playgrounds and other amenities [2:287].

For the cities of Zenica and Mostar, located in the valleys of the Bosna and Neretva rivers, he first identified one common principle by which places were traditionally built in valleys: residential neighbourhoods (mahale) were erected on hillsides, and the commercial town centre, the charshiya ('downtown'), in the valley. Next, he translated this into the principle of building housing on slopes and barren land, allowing the flat part of the valley to be used for industry or agriculture. Developing the concept for Zenica (Figure 8), he blended the new residential neighbourhood units with the hillsides along the valley of the Bosna, respecting the principles of the garden city, not creating isolated 'dormitory' neighbourhoods on Zenica's outskirts, but rather functionally rich organic wholes with all the amenities needed for modern living [2:287].



Figure 8. Axonometric drawing of Zenica town plan

One does not only find vegetation in residential parts of the city and the vast buffer zone that separates them from the industrial zone; it was also ‘let in’ the industrial part, which resulted in the urban form Neidhardt calls the amphitheatre city – ‘that which is so characteristic of our old towns, with the slopes merging with the valley into a harmonious whole’ [2: 457]. He compared Mostar to a crystal ore lump: ‘Like crystals incessantly form and develop inside amorphous ore lumps, may the modern era leave its mark on this agglomeration as well. Yet, the question is, are we, as architects and urban planners, up to the task of making additions to this stone agglomeration?’ In Herzegovina, with the little steep space that it has, serpentine and the like were built to create road infrastructure; just as vegetation changes, so does the structure of a city, and just as nature, the climate, people’s diet and customs impact on the temperament and physiognomy of the inhabitants of an area, so it is with the physiognomy of cities [2: 456].

These characteristics are seen in Neidhardt’s approach to the urban design of Ilidža, which fully adheres to the principles of the European modern movement and which was the first project of its kind in Bosnia and Herzegovina, as well as one of the first in the Kingdom of Yugoslavia. The Ilidža urban design banned all vehicles from inside the spa, with access roads passing along its perimeter, separated from the place itself with a protective vegetation belt. The railway line was separated with both a green belt and a protective embankment to minimise noise and smoke. The design proposed the separation of pedestrian motor traffic (local and collector/distributor roads), with a special system of parallel streets with extensions at their ends to be used by tenants as gathering places in all four newly designed residential neighborhood units.

The spa thoroughfare, the Great Promenade, was a pedestrian precinct, a walkway, which ran in the east-west direction, connecting the beaches along the river Željeznica, via the spa, with the River Bosna Spring. Along its length the walkway had a green median, the purpose of which was to break the monotony of the long promenade, with series of residential neighbourhoods to the north and south [3:262].

Neidhardt’s project of urban development regulation of Ilidža Spa included not only land use zoning of the entire place, but also density zoning, proposing zones of low, medium and high building density (as stipulated by the 1931 Building Act and the Construction Code, (which had a special chapter regulating spas and other tourist resorts), both of which were in effect at the time). Requirements were specified for each of the three density zones, and they all allowed only open-type neighbourhood units, which were an expression of modernist principles, which Neidhardt introduced with this Plan. The quadrangle was considered outdated, which precluded the construction of row houses or buildings in this case as well. Guided by housing quality standards, the project met the strict requirements for insolation, ventilation (airiness) and moisture control, not only by carefully planning the room and building layout, but also by landscaping the promenade to create the chequerboard pattern with trees. Each of the four residential neighbourhoods, which branched north and south of the green walkway, had a square at the centre of its administrative, cultural and economic part, complete with a school, market and other amenities. [6:55].

It is worthwhile noting that by designing such rounded neighbourhoods, which were also self-sufficient to an extent (such as will appear in the 1960s as both a constructive and critical response to the uniform commuter or dormitory towns, replicated before and after that time by stereotypically and formally employing functionalist principles, or the so-called neighbourhood unit concept), Neidhardt implemented an entirely new settlement planning strategy, thus interpreting CIAM’s – in Pantović’s words – ‘suprapolitical urban order’ in a genuinely inventive way, by adopting a just policy of communal life that struck a balance between common and special interests, public and

private dwelling and ownership, that is, a synthesis of the individual and the communal' [6:55, 5:20].

Also noticeable is Neidhardt's reference to the theory of modern functional town planning, as formulated in CIAM's first programme, The Declaration of La Sarraz, issued by architects gathered at the Preparatory International Congress of Modern Architecture in 1928. Not only Neidhardt, but also other Yugoslavian modern architects turned to the Declaration and worked towards its goals (the Declaration was translated into Croatian-Serbian and published in *Problems of Contemporary Architecture* (1932), a book by Croatian architect Stjepan Planić). Emphasising the central point of the Declaration, II. Urbanism, seems particularly important, if we are to understand Neidhardt's town planning postulates as observed in the case of the Ilidža Spa urban development regulation project. It formulates the essence of CIAM's theory of functional planning: '1. Urbanism is the organisation of functions of collective living... Urbanism should not be governed by aesthetic considerations, but exclusively by functions.' [5:18] It is indisputable that understanding architecture in the broader context of socio-political and economic conditions was the creative point of departure for Bosnia and Herzegovina's most prominent town planning figure. [6:56]

Following the above series of examples that illustrate the authenticity of Neidhardt's approach to architecture and town planning, it is important to point out his strong inclination towards exploration, experimentation and social engagement. He believed that an architect should be socially involved and participate in public life, just as he was and did himself. Many of his studies and competition entries, as well as his public appearances, resulted from his exploration of the widest range of urban and architectural phenomena and problems. His investigation of Bosnia's vernacular architecture did not only produce a book, but it also led to the compilation of the glossary of the modern vernacular language of architecture, in which he 'told' all his designs and projects.

Neidhardt's commitment to experimentation and work with new materials and technology in the field of residential building in the second half of the 1960s led to an initiative that, unfortunately, foundered. In a study presented at the Exhibition of Fine Artists of Yugoslavia in Sarajevo in 1969, as well as in several articles in the press and architectural magazines, he proposed architectural solutions for temporary accommodation of people in extreme situations, such as the Banja Luka earthquake. Thanks to the possibilities of serial production and modular architecture, these solutions were economical and feasible on the one hand, and human-friendly on the other. He introduced the idea of a meandering layout of temporary homes for victims of natural disasters that would give them a sense of individual freedom. This initiative came from Neidhardt's exploration of 'synthetic houses', which he elaborated in detail with his associates from the Sarajevo Institute for Materials and Structures and the Institute of Civil Engineering of Croatia in the period between 1965 and 1968 [3:235-240]. The inspiration for such affordable, modest and adaptable housing, which would be accessible to all, came from Le Corbusier's ideas on mass production of houses. Yet, Neidhardt's idea received little public attention at the time, despite the fact it clearly met the requirements that insisted on rationality and economy, and that it additionally catered to users – who were more often than not sadly neglected in these matters, as they are today – and their experience of architectural space.

4. UNDERSTANDING THE ORIGINS AND IMPACT OF NEIDHARDT'S DISCOURSE

Essentially, what ensured the contemporaneity and vitality of Neidhardt's modernist practice and complex architectural and urban discourse was his authentic use of elements of the local and traditional, i.e. vernacular. In Ljiljana Blagojević's words, modernity is understood as the quality of an architectural work that, while belonging to its epoch, interacts critically with the approved models and canons of that epoch [5: 213]. It was like this that Juraj Neidhardt's international modern architecture expressed the spirit of the place, fit in the new socialist society, and corresponded successfully with the peculiar social and cultural context of Bosnia and Herzegovina. 'Juraj Neidhardt's sensibility and his modern architecture, whose contemporaneity stems from his respect for the principles of local and vernacular architecture, reflect his simultaneous "living in two worlds": they have to do with the area in which he worked, to the state of architecture in the Austro-Hungarian Monarchy at the turn of the century and its attitude towards regional traditions, as well as to Le Corbusier's modern architecture and urbanism' [8: 223].

It is in that context that one should see Neidhardt's architecture as modern and search for the origins and influences of his architectural and urban discourse, because at the turn of the century the attitude towards heritage and the past became an important topic of architectural discourse in general and in the Austro-Hungarian Monarchy in particular. Setting a broad frame of reference for studying the

relationship between the vernacular and modern in the context of Banja Luka's urban transformation, Jelena Savić highlights the Austro-Hungarian period as a period of special dynamics in the history of the city and region, during which 'Viennese architects' discovered 'vernacular architecture' and reinterpreted creatively the experience of local building. She suggests that it is possible to link architectural themes in the capital of the Monarchy with the new Austro-Hungarian provinces because of the studies and projects by Ernst Lichtblau, from Otto Wagner's distinguished school. She assumes that it was Lichtblau's explorations, whose designs basically transposed the principles of vernacular architecture he had discovered, probably influenced the modern architect and professor Juraj Neidhardt [8: 215]. Also, there is indication of indirect influences of the work of a number of architects of the Austro-Hungarian period in Bosnia and Herzegovina, notably that of Josip Vancaš. They drew on vernacular architecture for the creation of structures that belonged to their era both functionally and logically. They emphasised the peculiarities of local identity, distancing themselves from historical styles and Ottoman heritage. Although they used the term the 'Bosnian bond' to label the style they had discovered the 'proper' one, these authors did not seek to create a 'national style' [8: 208].

Neidhardt's modernist architectural and urban designs also possess regional characteristics, and they may be seen as the earliest representation and expression of critical regionalism, which was to grow in strength in Bosnia and Herzegovina in the 1970s. It is a true embodiment of the ideas of modern architecture due to its being a 'synthesis of the universal and the regional', and it is dedicated to creative dialogue with heritage [8: 224]. Critical regionalism is proof of the capacity of the local and vernacular to be contemporary and initiate self-renewal under the umbrella of modernity, and it is also a critical element of modernity as such.

In addition to Juraj Neidhardt, in the 1960s and the 1970s, Bosnia and Herzegovina saw the work of such great critical regionalists as Zlatko Ugljen, Ranko Radović, Nedžad Kurta, Radivoje Jadrić and Džemaludin Karić [8: 224]. Although Kenneth Frampton (1983, 1985) is responsible for making critical regionalism popular on a planetary scale, it was the Greek architect Alexander Tzonis and art historian Liana Lefaivre who coined the term 'critical regionalism' in their 1981 poetic description of the work by Dimitris and Susanna Antonakakis [13:32]. In his *Towards a Critical Regionalism: Six Points for an Architecture of Resistance*, Frampton describes critical regionalism as a concept of 'architecture of resistance', one that opposes the imposition of universal standards for all, cultural commodification and the worship of technology, and one which should encourage the integration of tradition and modernity. [10:21]. As such, it does not mean vernacular architecture born spontaneously out of climate, culture, myth and crafts in contact, but regional schools of modern architecture turned in a sense to their roots [13:33].

5. CONCLUSION

The conclusion of this investigation into the lasting appreciation of the qualities and principles of local building traditions and their creative power in Bosnia and Herzegovina's architecture in the period between the end of the 19th century and the end of the 20th century is that the complexity, modernity and vitality of Juraj Neidhardt's urban and architectural discourse truly set it apart from the work of other architects and builders. Although it is clearly distinct from the romantic regionalism of the Austro-Hungarian period and the subsequent critical regionalism, it also connects them, being the predecessor of the concept and an influencer, assuring us that they can all be important in the future for creating new value and architectural works, i.e. for re-examining the relationship toward old or inherited values and their creative renewal.

In addition, the above-given examples of universal principles underlying the architectural heritage of Bosnia and Hercegovina and the special qualities of its modernist architecture can provide a firm basis for assessing the modernist heritage still awaiting valuation, including both early modernism and its post-WWII, social realist version. These facts bring us face-to-face with the process of revaluation of the entire material heritage of the modernist era [1:39]. Given the fact that a number of Neidhardt's buildings have been destroyed or seriously damaged in the last civil war, as have great architectural pieces by other Bosnian-Herzegovinian architects, there is a real need to reconsider and conceptualise alternative approaches to their restoration.

LITERATURE

- [1] D. Simonovic and T.Vujicic, "Valuation and reactivation of the 20th-century industrial heritage and its relevance for strengthening the cultural identity of the Republic of Srpska". In Browninfo. Toward a methodological framework for brownfield database development, A. Đukić, D. Simonović, and T. Vujičić, Eds. Banjaluka: University of Banjaluka, Faculty of Architecture, Civil Engineering and Geodesy, 2014, pp. 23-41.
- [2] D. Grabrijan and J. Neidhardt, *Arhitektura Bosne i put u savremeno/ Architecture of Bosnia and the Way of Modernity*. Ljubljana: Državna založba Slovenije, NR Bosna i Hercegovina, NR Slovenija, 1957.
- [3] J. K. Kapetanović, *Juraj Najdhart. Život i djelo*. Sarajevo: Veselin Masleša, 1990.
- [4] E. Ben-Joseph, *The Code of the City*. Standards and the Hidden Language of Place Making. Cambridge, Ma, London: The MIT Press, 2005.
- [5] LJ. Blagojević. „Strategije modernizma u planiranju i projektovanju urbanističke strukture Novog Beograda: period konceptualne faze od 1922 do 1962. godine“ [Strategies of Modernism in the planning and design of urban structure of New Belgrade: the period of the conceptual phase from 1922 to 1962]. PhD dissertation, AFUB, Belgrade, 2004.
- [6] D. Simonović, "Rehabilitation of Urban Identity of Cities in the Banja Luka Region through Urban Form Regulation". SPATIUM International Review No. 30, 2013, pp. 28-32.
- [7] D. Simonović, "Istraživanje mogućnosti obnove i unapređenja identiteta pejzažnog grada Banjaluke putem urbanističke regulacije" [Research into the possibility of rehabilitation and upgrade of the urban identity of Banja Luka as a landscape city through urban regulation]. (PhD dissertation). AGGF UNIBL, Banjaluka, 2014.
- [8] J. Savić. "Moderno i vernakularno u procesu urbane transformacije Banjaluke" [Modern and vernacular in the process of the urban transformation of Banja Luka]. PhD dissertation, AFUB, Belgrade, 2013.
- [9] P.V. Milošević, *Arhitektura u Kraljevini Jugoslaviji (Sarajevo 1918-41)*. Srbinje: Prosvjeta, 1997.
- [10] K. Frempton, (1985). *Modern Architecture a Critical History*. London: Thames & Hudson.
- [11] K. Frempton, „Towards a Critical Regionalism: Six Points for an Architecture of Resistance“. In *The Anti-Aesthetic Essays on Postmodern Culture*. Hal Foster, Ed., Washington: Bay Press, Port Townsend, 1983, pp. 16-30.
- [12] Marina Radulj, Maja Milić Aleksić, Ognjen Šukalo. „Critical Resistance of a Hut – in six points (Cultivation Of Critical Practice Through The Memorial House Design By The Architect Ranko Radović) AGG+ Journal for Architecture, Civil Engineering, Geodesy and related scientific fields. University of Banja Luka Faculty of architecture, Civil Engineering and Geodesy / АГГ+ часопис за архитектуру, грађевинарство, геодезију и сродне научне области, 034-047.
- [13] Krunoslav Ivanišin. "Regionalizam ili globalizacija: budućnost mediteranskog pejzaža", *ZAREZ IV/78*, 32-33.

25

Research paper | Оригинални научни рад
DOI 10.7251/STP2215267V
ISSN 2566-4484



Miroslav Vujasinović, University of Banja Luka, miroslav.vujasinovic@aggf.unibl.org

Dragana Skorup, University of Banja Luka, dragana.skorup@aggf.unibl.org

POSSIBILITY OF USING SENTINEL RADAR SATELLITE IMAGES

Abstract

The use of active radar systems ensured the acquisition data of Earth's surface on any place and at all time, in any atmospheric conditions. This paper presents the possibility of a Sentinel radar satellite system and the advantage of publicly available data and open source software solutions.

Keywords: SAR (Synthetic Aperture Radar), Sentinel, Copernicus, SNAP, Microwaves

MOGUĆNOST UPOTREBE SENTINEL RADARSKIH SATELITSKIH SNIMAKA

Сажетак

Употреба активних радарских система обезбиједила је снимање Земљине површи на било ком мјесту у било које вријеме, без обзира на стање у атмосфери. У овом раду приказана је могућност Сентинел радарског сателитског система, те предност јавно доступних података и софтверских рјешења отвореног кода.

Кључне ријечи: SAR (Синтетички Апертуре Радар), Сентинел, Цопернициус, СНАП, микроталаси

1. UVOD

Opažanje Zemlje počelo je satelitskim sistemima koji su vršili opažanja u vidljivom i infracrvenom dijelu elektromagnetnog spektra. Iako, tada veliki pomak u osmatranju Zemljne površine, nije bio mnogo upotrebljiv zbog nedostataka i ograničenja koji su imali ovi sistemi. Osnovna ograničenja koja su postavljena pred ovim satelitskim sistemima su nemogućnost opažanja u uslovima gdje nema dovoljno svjetla, dakle, noćna snimanja nisu moguća. U tropskim krajevima gdje je u većem dijelu godine oblačno nije moguće vršiti snimanja.

Ovo su neki od razloga zašto je bilo neophodno razviti tehnologiju koja bi mogla prevazići navedene nedostatke. Iz ovog su proizašli radarski sistemi, a kasnije i SAR (Synthetic Aperture Radar) koji se baziraju na aktivnim sensorima. Pojam rada se koristi kao naziv i za tehnologiju ali i za instrument pomoću koga se vrši opažanje. Radarski senzori emituju impulse u mikrotalasnom opsegu [1] [2].

1.1. ELEKTROMAGNETNI SPEKTAR

EM spektar se može podijeliti po frekvencijama, talasnim dužinama i minimalnim iznosima energije koje talas razmjenjuje sa naelektrisanim česticama. Prema terminima koji se koriste u elektrotehnici, elektromagnetni spektar se dijeli na područja Gama i H zraka, ultraljubičastu oblast, vidljivu oblast, infracrvenu oblast, mikrotalasnu oblast i područje radio talasa (ENF, SHF, UHF, VHF, HF). Za geodetsku struku interesantan je mikrotalasni opseg u koji spadaju EHF, SHF i UHF u okviru koga rade radarski sistemi [1].

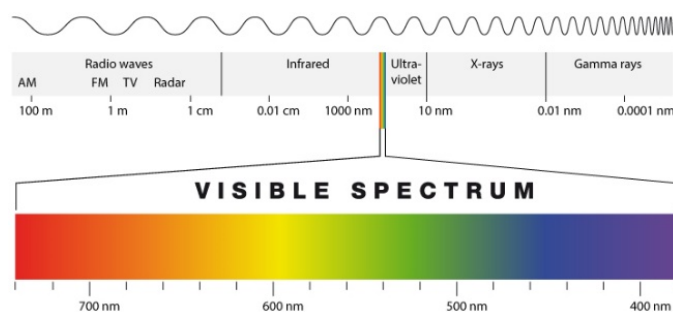

Slika 1. Elektromagnetni spektar [3]

1.2. MIKROTALASI

Talasne dužine mikrotalasa kreću se u rasponu od $\lambda = 1$ mm do $\lambda = 1$ m, što odgovara frekvenciji od 300 MHz do 300 GHz.

Ovi talasi imaju mogućnost da se kreću kroz atmosferu bez smetnji, te su iz tog razloga značajni za snimanje aktivnim sensorima u daljinskim istraživanjima. Atmosferske smetnje, kao što su oblaci, dim, i sl. ne utiču na prostiranje mikrotalasa. U talasnom području mikrotalasa pored aktivnog zračenja, postoji i pasivno zračenje. Ako površina sama zrači zracima u mikrotalasnom opsegu, radi se o pasivnom zračenju. Ovo zračenje je dosta slabo, pa se ne može koristiti za interpretaciju sadržaja snimaka u postupcima daljinskog istraživanja [1].

Mikrotalasi koji se proizvode u aktivnim izvorima, šalju se iz aviona ili satelita, poprečno na pravac kretanja letjelice, a reflektovani signali od površine zemlje registruju se u letjelici i pretvaraju se u snimak, a postupak se naziva radarsko snimanje [2].

2. METODOLOGIJA

Radarski sistemi sa aktivnim sensorima primjenjuju se u različitim granama nauke i privrede [2]. Postoje različite platforme sa komercijalnim snimcima ili javno dostupnim snimcima kao što je Sentinel misija [4]. U okviru ovog dijela predstavljen je osnovni princip prikupljanja podataka SAR sistemima i osnovni pojmovi koji se odnose na radarska snimanja, koja mogu da olakšaju obradu i interpretaciju snimaka.

2.1. PODRUČJE ISTRAŽIVANJA

Područje istraživanja nalazi se u Republici Srpskoj (Bosna i Hercegovina), u dijelu Banjalučke regije. Ono obuhvata nizijski dio ka rijeci Savi na sjeveru dok na jugu i na zapadu obuhvata brdoviti i planinski dio. Cilj istraživanja je izrada digitalnog modela terena za područje od nekoliko stotina kvadratnih kilometara, na osnovu javno dostupnih podataka, u što kraćem vremenskom periodu, u softverskom rješenju otvorenog koda. Podaci koji su korišćeni za izradu digitalnog modela terena

su prikupljeni radarskim satelitskim sistemima Sentinel 1A i Sentinel 1B, a snimci su dostupni za preuzimanje na Copernicus Hub platformi. Vremenska rezolucija za snimke prikupljane samo Sentinel 1A sistemom je 12 dana, a nakon aktiviranja Sentinel 1B, rezolucija je povećana na 6 dana.

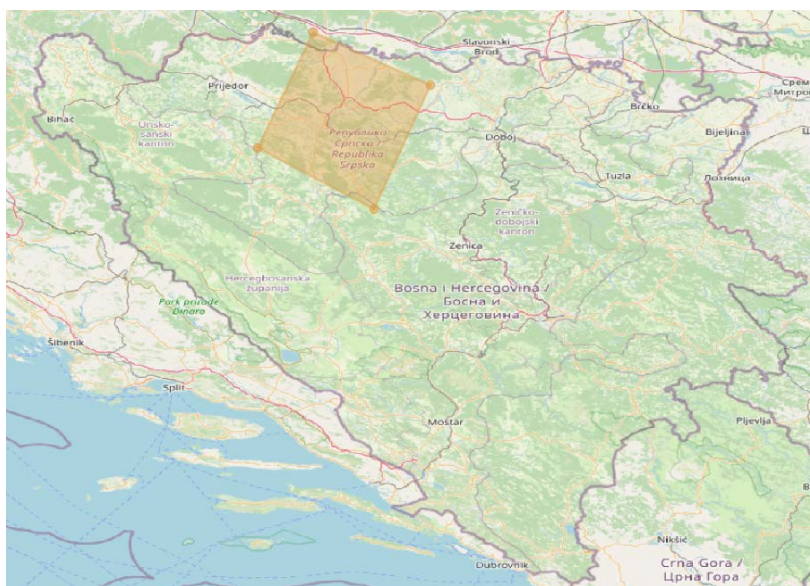

Slika 2. Područje istraživanja

2.2. OSNOVNI POJMOVI SAR RADARSKOG SNIMANJA

Kretanje jedne antene duž neke linije je ekvivalentno nizu antena duž iste linije, sve dok se primljeni signali koherentno snimaju, pod pretpostavkom da je cilj koji je osvijetljen nepomičan tokom perioda kretanja ili je poznat način njegovog ponašanja [1] [4].

Pretpostavimo da se radarski senzor kreće konstantom brzinom V i da ima antenu dužine L . Otisak koji pravi snop za tlu jednak je [1]:

$$\zeta = \frac{2\lambda h}{L}, \quad (1)$$

Kako se senzor kreće, uzastopni reflektovani talasi se snimaju u tačkama, x_1, x_2, \dots, x_i , duž linije kretanja satelita. Ugrađeni stabilni oscilator se koristi kao referenca, a reflektovani talasi se snimaju koherentno, to su, amplituda i faza u funkciji vremena. Primljeni talasi se kombinuju u procesoru kako bi se spojili u linearan niz. Spojeni niz će imati širinu zraka jednaku [1] [2]:

$$\theta_s = \frac{\lambda}{\zeta} = \frac{L}{2h}, \quad (2)$$

I rezultat otiska niza na tlu je:

$$X_a = h\theta_s = \frac{L}{2}, \quad (3)$$

Korišćenjem sintetičkog niza postiže se značajno bolja rezolucija snimaka. Rezolucija koja se postiže ovom metodom nezavisna je od udaljenosti između senzora i oblasti koja se snima. Pored toga, bolja rezolucija se može postići sa manjom antenom. Ova nezavisnost proizilazi iz činjenice, da, što je senzor dalje, veći je otisak na tlu, a samim tim duži i sintetički niz, ovo dovodi do finijeg sintetičkog snopa čime se uravnotežuje povećanje udaljenosti. Takođe, u praksi povećanje rezolucije postiže se sa manjom antenom [1] [5].

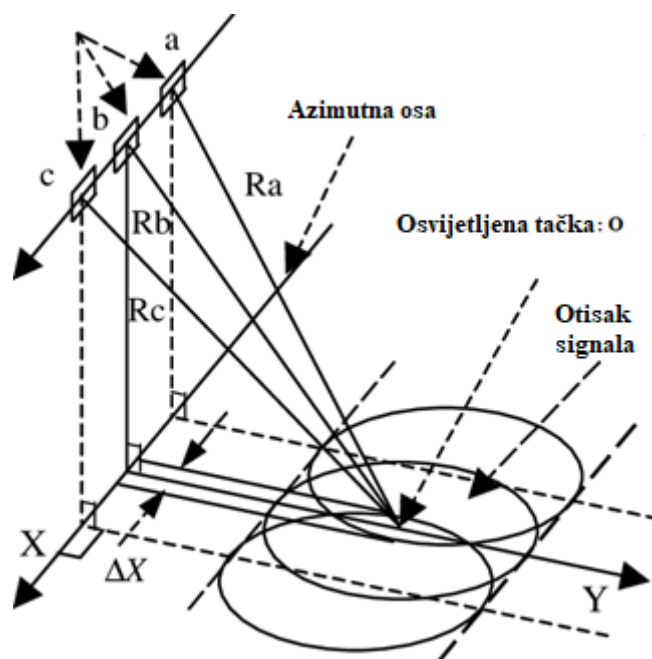

Slika 3. Radar sa sintetičkim otvorom blende [6]

2.3. SAR POLARIZACIJA

Polarizacija je važan faktor za snimanje terena i kasnije analizu podataka, na osnovu ovih podataka moguće je odrediti kolika je biomasa, koliko je uznapredovala biljka, da li biljka ima plodove i slično. Tipovi polarizacije mogu da budu HH, VV, HV, VH [2].

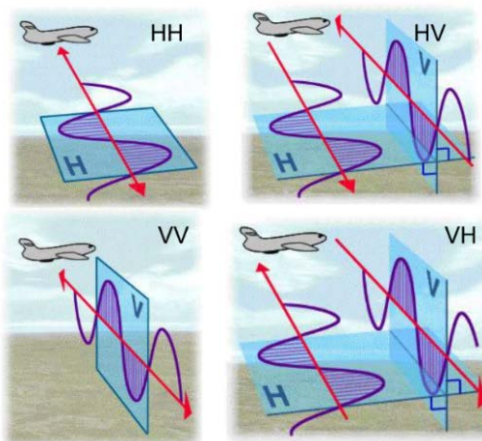

Slika 4. Vrste polarizacije [2]

Pomoću antene moguće je izazvati elektromagnetni talas da njegovo električno polje osciluje u ravni koja je paralelna sa terenom ili na upravnoj ravni. Ukoliko je tip polarizacije HH, prvo slovo označava tip polarizacije talasa koji emituje antena, a drugo slovo označava polarizaciju koju ima primljeni reflektovani talas. Ovakvo osmatranje tla naziva se HH polarizacija snimanja. Kod VV polarizacije, V je vertikalno polarizovan talas koji se šalje iz antene, dok se od tla reflektuje isto vertikalno polarizovan talas [7].

Elektromagnetni talasi prirodno mijenjaju polarizaciju, npr. sunčeva svjetlost je po prirodi nepolarizovana, ali ako se odbije od vodu, ona postaje polarizovana. Obzirom da se i talasi koji su poslani iz antene odbijaju od različitih materijala, različitih oblika, različite grubosti i čvrstoće, od svega toga zavisi da li će horizontalno polarizovani talas vratiti kao takav ili će promijeniti polarizaciju [7].

Reflektovani signal u sebi nosi i horizontalnu i vertikalnu polarizaciju ali su antene podešene tako da registruju samo horizontalno ili vertikalno polarizovan talas.

3. OBRADA RADARSKIH SNIMAKA

U eksperimentalnom dijelu rada obrađeni su satelitski snimci prikupljeni satelitskom misijom SENTINEL-1, a javno dostupni kroz platformu COPERNICUS-HUB.

Prilikom preuzimanja podataka za potrebe dalje izrade digitalnog modela terena neophodno je da snimci zadovoljavaju određene karakteristike, a to su [8]:

- Potrebno je izabrati parove snimaka sa što većom upravnom bazom, ne bi trebalo da baza bude manja od 40 m;
- Potrebno je izbjegavati snimke nastale tokom kišnih i snježnih padavina;
- Poželjno je odabrati snimke prikupljene tokom noći jer su manje pogođeni uticajima atmosfere;
- Potrebno je izbjegavati snimke nastale tokom veoma toplih ljetnih dana.

Pretraga snimaka sa najpovoljnijom baznom linijom moguće je izvršiti na platformi ASD Baseline Tool. Ovaj alat omogućava pretragu i određivanje idealnog para snimaka. Nakon odabira najpovoljnijeg para snimaka na Copernicus Open Access Hub platformi, mogu se pronaći isti snimci i preuzeti. Ukoliko snimci nisu odmah dostupni, moguće je zatražiti snimke, te će oni biti dostupni kroz 24 časa [9].

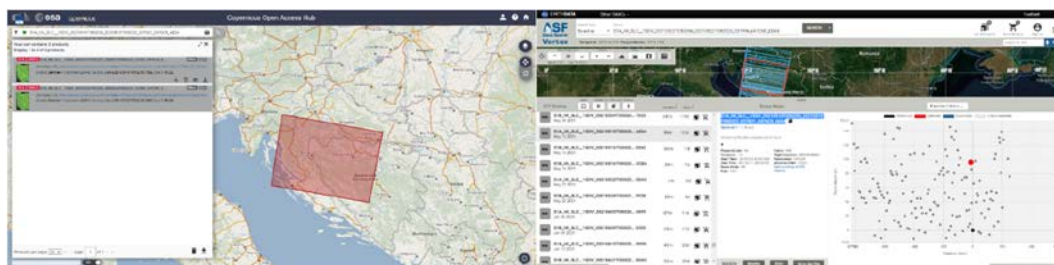

Slika 5. Preuzimanje podataka (lijevo Copernicus Open Access Hub, desno ASD Baseline Tool)

3.1. OBRADA PODATAKA U PROGRAMSKOM PAKETU SNAP

Obrada podataka izvršena je u SNAP softverskom rješenju otvorenog koda koje predstavlja softversko rješenje namijenjeno prvenstveno za potrebe obrade snimaka prikupljenih satelitskim platformama.

Prvi korak u koregistraciji je isijecanje i odabir željenih traka snimaka i tipa polarizacije. Za ovo područje odabran je IW2 (Interferometric Wide Swath 2) tip, i tip polarizacije VV [9] [10]. Naredni korak je dodavanje podataka o orbitama pomoću funkcije pod nazivom Apply Orbit Information. Informacije o orbitama sadrže vektore položaja satelita u intervalima od po 10 sekundi. Podaci o preciznim efemeridama se generišu svakog dana i dostupni su 20 dana nakon akvizicije [9] [10].

Formiranje interferograma se vrši prema dijagramu kao na Slici 6. Potrebno je uvesti dva snimka Read i Read (2), snimci se međusobno preklapaju u okviru funkcije Back-Geocoding pomoću metapodataka u okviru kojih se nalaze podaci o položaju. Da bi se izvršila kvalitetnija koregistracija, moguće je primijeniti funkciju Enhanced-Spectral-Diversity, nad proizvodom generisanim u postupku obrnutog geokodiranja. U okviru obrade koristi se približni digitalni model terena SRTM 1sec HGT, ovaj set podataka omogućava da se na osnovu njega isijeku jezera i rijeke koje se nalaze na snimanom području. Interferogram se izrađuje međusobnim unakrsnim množenjem glavnog snimka sa složenom konjukcijom drugog snimka. Amplitude snimaka se množe a faze predstavljaju faznu razliku među slikama. Za uklanjanje graničnih linija između traka koristi se funkcija TOPSAR-Deburst, nad posljednjim generisanim proizvodom, a to je interferogram [10].

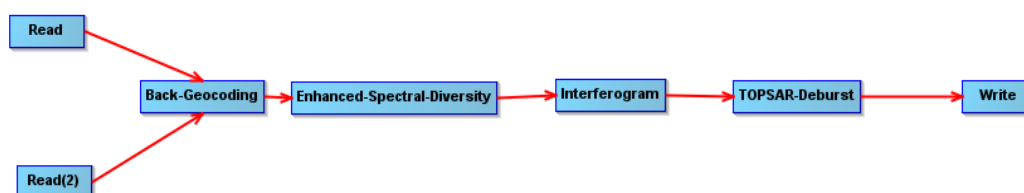

Slika 6. Postupak kreiranja interferograma

Varijacija faze zavisi od nekoliko faktora, a to su [9] [10]:

- Faza ravne Zemlje, φ_{flat} , uticaj Zemljine zakrivljenosti;
- Topografska faza, φ_{DEM} , uticaj topografije terena;
- Atmosferska faza, φ_{atm} , uticaj atmosferskih uslova;
- Faza šuma, φ_{noise} , uticaj šuma, odnosno uticaja raspršivanja zapremine, različitog ugla gledanja,
- Površinska faza, φ_{disp} , uticaj površinske deformacije koja se eventualno desila između dvije akvizicije

$$\varphi = \varphi_{DEM} + \varphi_{flat} + \varphi_{disp} + \varphi_{atm} + \varphi_{noise} \quad (4)$$

Fazna informacija u područjima koja su nekorelisana ne može biti popunjena, ali zato može biti povećan kvalitet „resa“ [2]. Za rješavanje ovog zadatka koristi se Goldensteinde Phase filtriranje, rezultat ovoga je uklopljeni snimak.

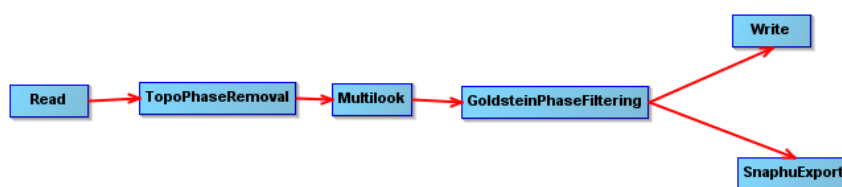

Slika 7. Postupak uklanjanja fazne neodređenosti i objedinjavanje snimaka

U okviru interfereograma, interfereometrijska faza ima neodređenost, poznata je samo u opsegu od 0 do 2π . Kako bi se neodređenost riješila potrebno je da izvrši postupak odmotavanja. Fazno odmotavanje rješava faznu neodređenost, a postupak podrazumijeva [9]:

- Izvoz zamotane faze i zadavanje parametara;
- Odmotavanje faze pomoću softverskog rješenja otvorenog koda SNAPHU;
- Uvoz odmotane faze u SNAP.

Nakon kreiranja odmotanog neprekidnog rastera, predstoji još jedan korak, koji rješava problem mjerljivosti. Kako bi se vrijednosti iz radijana prevele u apsolutne, primjenjuje se funkcija Phase to Elevation operator [9] [10]. Kako bi se visine postavile na određeni nivo, potrebno je iskoristiti približni DEM. Poslednji korak je primjena funkcije Range Doppler Terrain Correction koja rješava geometrijska izobličenja, kao što su prekidi i sijenke. Rezultat kompletnog procesa je rasterski tip fajla, georeferenciran i spreman za korišćenja u različitim GIS alatima, za dalje analize [9] [10].

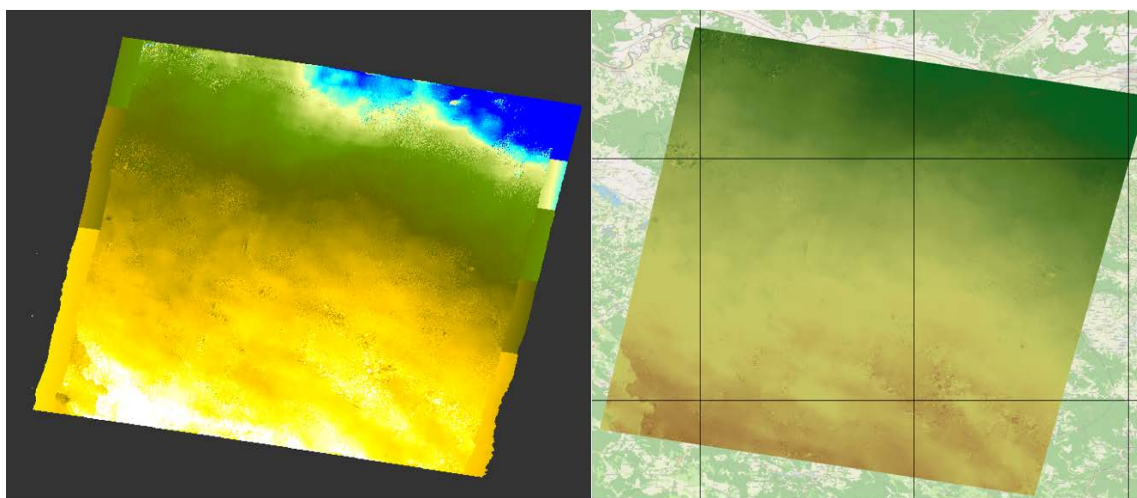

Slika 8. Rezultat izrade digitalnog modela terena (lijevo SNAP, desno QGIS)

4. ZAKLJUČAK

Satelitska tehnologija omogućila je da Zemljinu površ i sve u blizini nje sagledamo iz drugog ugla, na bilo kom mjestu na Zemlji. Prepreke kao što su događaji u atmosferi, oblačnost, vodena para i slično, koje su predstavljene zamračenjima na snimcima koji su prikupljeni putem pasivnih senzora, prevaziđeni su primjenom radarske tehnologije. Radarski sistemi, su aktivni senzori koji rade u mikrotalasnom opsegu te za njih ne postoje prepreke i ne zavise od doba dana u kojima se prikupljaju snimci.

Poznato je da je daljinska detekcija veoma efikasna po pitanju prikupljanja velike količine podataka i pronašla je primjenu u različitim strukama te postala dio svakodnevnice. Daljinska detekcija prepoznata je i u ciljevima održivog razvoja u pet ciljeva (svijet bez siromaštva, industrija, inovacije i infrastruktura, klimatske promjene, podvodni svijet, nadzemni svijet), što nagovještava ulaganja u satelitske sisteme te buduća usavršavanja i unapređenja.

SAR tehnologija omogućila je široku primjenu u različitim oblastima, prvi lansirani SENTINEL satelit, pružao je vremensku rezoluciju svakih 12 dana, lansiranjem drugog satelita vremenska rezolucija smanjena je na 6 dana, a očekuje se da će se u skorijoj budućnosti vremenska rezolucija povećati na 2 dana.

LITERATURA

- [1] C. Elachi, J. Zyn, Introduction to the Physics and Techniques of Remote Sensing. John Wiley & Sons, New Jersey, 2006.
- [2] Rees, W. G.: Physical Principles of Remote Sensing. Cambridge, 2021
- [3] MiniPhysics, Available: https://www.miniphysics.com/electromagnetic-spectrum_25.html, pristup: 8. mart 2022.
- [4] Bočkor, M.: „Određivanje površinskih pomaka tla uz pomoć InSAR Sentinel-1 satelitskih podataka“, Geološki fakultet Univerziteta u Zagrebu, Zagreb, 2021.
- [5] Chen, Y.Q., Zhang, G. B., Ding, X.L. and Li, Z.L: „Monitoring Earth Surface Deformations with InSAR Technology: Principle and Some critical Issues“, Journal of Geospatial Engineering, Vol. 2, No. 1, pp. 3-21, 1999
- [6] Ohki, M., Abe, T., Tadono, T., „Shimada, M.: Landslide detection in mountainous forest areas using polarimetry and interferometric coherence“, Earth, Planets and Space, 2020.
- [7] Anderson, F., Herndon, K., Thapa, R., Cherrington, E. The Synthetic Aperture Radar (SAR) Handbook: Comprehensive Methodologies for Forest Monitoring and Biomass Estimation. NASA, 2019.
- [8] A. Braun, Retrieval of digital elevation models from Sentinel-1 radar data – open applications, techniques, and limitations, Open Geosciences, 2021.
- [9] A. Braun, DEM generation with Sentinel-1, ESA Skywatch, 2020.
- [10] Матић, Д. „Израда и верификација дигиталног модела висина на основу података сателитске мисије SENTINEL-1“ мастер рад, Грађевински факултет Универзитета у Београду, Београд, 2021.
- [11] Prpa, M. „Zemljotres u turskoj (2020): Koseizmičke deformacije tla na osnovu SAR snimaka“, master rad, Rudarsko-geološki fakultet, Univerzitet u Beogradu, Beograd, 2020.
- [12] Tizzani, P., Berardino, P., Euillades, P., Manzo, M., Gicciardi, G. P., Zeni, G., Lanari, R. „Surface deformation of Long Valley caldera and Mono Basin. California investigated with the SBAS-InSAR approach“, Remote Sensing of Environment, 2006
- [13] Rauff, K. Abir, I.: „Application of InSAR technique for the detection of ground displacement in penang island“, International Jurnal of Geomate, Malasia, 2021.



Gordana Jakovljević, University of Banja Luka, gordana.jakovljevic@aggf.unibl.org
Miro Govedarica, University of Novi Sad, miro@uns.ac.rs
Flor Alvarez Taboada, Universidad de León, flor.alvarez@unileon.es

IPHONE 13 PRO VS PROFESSIONAL TLS FOR 3D INDOOR MAPPING

Abstract

In recent years, fast and simple acquisition of geospatial data, fast processing, and distribution is a trend that characterizes geoinformation technologies. The primacy of the acquisition is based on image processing technology and laser scanning. This paper attempts to answer how acceptable these technologies are incorporated into smartphones which can be used for data acquisition. A comparative analysis of the results collected by smartphone and professional laser scanners has been made. The results presented in the paper confirm the usability of the iPhone LiDAR device in the acquisition of point cloud and the development of 3D models of indoor spaces.

Keywords: LiDAR, iPhone 13 pro, Terrestrial Laser Scanning

АЈФОН 13 ПРО ИЛИ ПРОФЕСИОНАЛНИ ЛАСЕРСКИ СКЕНЕР ЗА 3Д КАРТИРАЊЕ УНУТРАШЊОСТИ ОБЈЕКТА

Сажетак

У данашње време брза и једноставна аквизиција геопросторних података, брза обрада и дистрибуција је тренд који карактерише геоинформационе технологије. Примат у аквизицију се базира на технологији обраде слике и ласерском скенирању. Овај рад покушава да да одговор колико су прихватљиве ове технологије инкорпориране у једноставне непрофесионалне уређаје типа мобилног телефона који се могу користити за аквизицију података. Направљена је упоредна анализа аквизиција у резултатима прикупљеним мобилним телефоном и професионалним ласерским скенером. Резултати презентовани у раду потврђују употребни апсект аквизиције мобилних уређаја у изради 3д модела унутрашњег простора.

Кључне ријечи: Лидар, Ајфон 13 про, терестрички ласерски скенер

1. INTRODUCTION

In recent years, demand for detailed and accurate 3D models of indoor spaces has been increased significantly due to their wide application such as construction, indoor navigation, conservation and reconstruction of historical and cultural heritage, promotion of tourist attractions, spatial planning, or development of Building Information Modeling (BIM).

In order to provide a sufficient level of detail, the models need to be based on reliable measurement data. Most often the point clouds represent the raw material for the development of 3D models. Different surveying technologies can be used to collect point clouds from indoor environments such as laser scanning, close-range photogrammetry, depth camera, or simultaneous localization and mapping (SLAM). However, there are several limitations that need to be considered.

The mobile depth camera requires optimization of light conditions and can provide accurate results for smaller room sizes [1].

Close-range photogrammetry uses photographs of the same object taken from different angles to create a 3D point cloud of the object. The geometric representation of the object is created by using a tie point between at least 3 different images. [2] used close-range photogrammetry for 3D modeling of the complex indoor gothic church providing dense point cloud and quality textures. The accuracy of the resulting model is highly influenced by light conditions and camera-resolution which can result in a lack of points and unclear surfaces; therefore, additional lighting is crucial. Although photogrammetric with the nonmetric camera is an inexpensive method it provides less accurate results [3] and demands more careful planning compared to TLS [2].

Laser scanning technology has been widely used for mapping complex environments, resulting in the highly detailed point cloud that can be used for obtaining a 3D model, geometrical analysis, and extraction of characteristic elements such as cross-sections, edges, axes. Two types of laser scanning are widely used for indoor mapping, Terrestrial Laser Scanner (TLS), and Mobile Laser Scanner (MLS). The mobile mapping systems (MMS), based on robot-carried devices have been used to map indoor spaces. SLAM is proposed to solve the problem of robot localization and navigation in an unknown environment. The system is equipped with navigation such as global navigation satellite system (GNSS) and inertial measurement unit (IMU) and imaging sensors such as laser scanning and cameras. The robot uses sensor measurement to build maps incrementally.

Since the application of vehicle-borne MMS in indoor spaces is limited due to size and difficulties in moving the backpack (MMS) has been widely used. [4] applied the 3D laser SLAM algorithm to mobile mapping to acquire geographical information in a complex indoor environment achieving a relative precision of point cloud of 2-4 cm. [5] tested the performance of laser-based and photogrammetric-based backpack system to TLS. The absolute error was 16.3 cm and 50.3 cm; while the relative error was 8.2 cm and 6.1 cm for the laser-based backpack and photogrammetry, respectively. Although SLAM can produce centimeter-level accuracy, it is expensive, the positional accuracy will degrade with an increase of the mapping territory due to cumulative error [6], and registration of point clouds from multiple tasks or robots is challenging [7].

TLS represents one type of laser scanning which is based on Light Detecting and Ranging (LiDAR). Several studies have applied the TLS in 3D indoor modeling [8], [9], and [10]. TLS has been accepted as the standard technology for 3D data acquisition, enabling high-quality point clouds with high precision and accuracy and a high level of detail [11]. Due to that, it is usually used as the reference data for comparison with other methods or more affordable devices [12]. However, TLS is based on the static data collection principle demanding multiple scanning positions in order to obtain sufficient data. In addition, the overlap between scenes needs to be provided in order to register point clouds. Due to that, it is time-consuming, especially in a large and complex environment. Additional measurements with traditional surveying techniques are needed if the point cloud should be georeferenced [13]. This also increases the time needed for data collection especially when multiple rooms are scanned. Moreover, TLS has some limitations, including weather conditions, dust, object materials, surface reflectivity, and surface roughness. It is hard to measure highly reflective surfaces such as glass or mirrors. Even reflective coating on furniture can create issues requiring multiple scenes to deal with specular reflection.

However, TLS and MMS tend to be expensive due to involved laser scanning device(s) or multiple cameras thus the application for the end-user is typically reduced. Due to technological development more and more sensor systems have become available for 3D indoor mapping in order to address those limitations.

The low-cost RGB-D camera with high frame rates has become a popular method for fast static and dynamic scene reconstruction. However, such a system has limited accuracy of geometrical acquisition due to sensor noise, limited resolution, and misalignments due to movement [14]. The

Microsoft HoloLens representing mobile, head-worn augmented reality (AR) devices have become a popular device for indoor mapping. The quantitative evaluation shows that HoloLens allows fast acquisition of basic single room geometry within a few centimeters [15]. In the case of multiple rooms connected by narrow passages, the larger deviations occur but accuracy is still sufficient for a 3D model of the indoor scene [15], [16].

In recent years, there has been rapid progress in enabling laser scanning technologies in mobile devices such as smartphones and pads. The LiDAR sensor has been included in iPhone 12 pro and iPhone 13 pro. Unlike the expensive solutions based on TLS or MLS, smartphones and tablets were increasingly affordable in everyday practice.

The study aims to evaluate the indoor mapping capacity of the iPhone 13 pro LiDAR sensor with respect to the mapping: room geometry itself i.e. dimensions of rooms and its elements (door, windows), mapping the fine geometrical details of the room, and mapping of flat and curved surfaces.

2. MATERIALS

The performance of the customer-level device and classic TLS was performed on the rectangular shape room whose dimensions are 7.7 m x 3.9 m. Although the room has simple geometry (except one column, two ceiling beams, and several pipes) it is full of furniture and small details on shelves. In addition, on the north wall, there are two large windows.

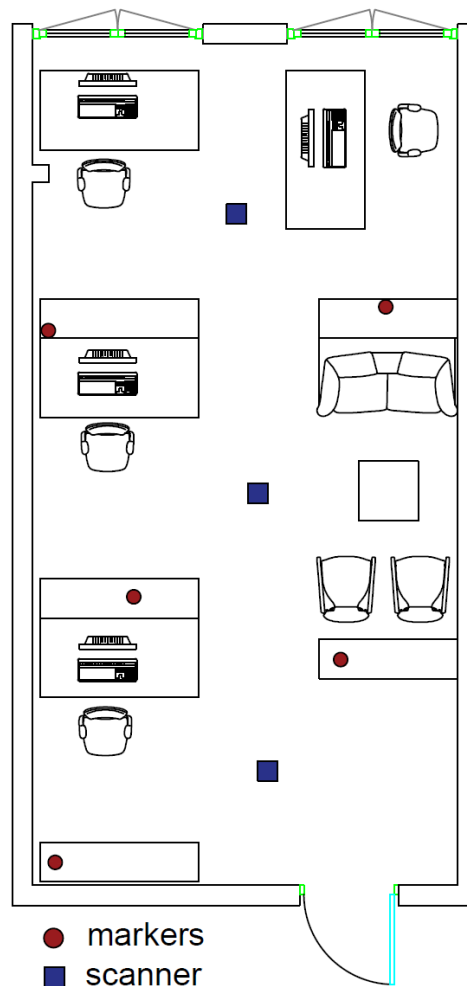

Figure 1. Study area with markers and TLS positions

The TLS data used in this study were captured using Faro Focus M 70 laser scanner. Focus M 70 uses phase-based time of flight measurement to estimate distance to object. The scanner covers 360° x 300° field of view. The technical details of scanner are listed in Table 1.

Table 1. Characteristics of Faro Focus M 70 laser scanner

Characteristic	M 70	iPhone 13 pro
Range	0.6-70 m	-
Unambiguity interval	614 m for up to 0.5 mil pts/sec	-
Range accuracy	± 3 mm	-
Integrated color camera	Yes	Yes
Sensors	Dual axis compensator, Height Sensor, Compass, Integrated GPS&GLONASS	Built-in GPS, GLONASS, Galileo, QZSS and BeiDou, Digital compass

iPhone 13 pro is equipped with LiDAR scanner primarily to improve the quality of night mode portraits since vertical cavity surface-emitting laser (VCSELs) provide 10-100 times higher brightness than LEDs enabling focused illumination at large distances [17]. However, integrated sensor can also be used the point cloud acquisition. VCSEL technology provide a combination of narrow spectrum, high efficient, fast pulse rise time and minimal spectral shift with temperature. iPhone LiDAR send light using an array of VCSELs. It detects reflected beam using an array of single-photon avalanche diodes. Although, classic laser scanners include one laser beam and moving mirror that deflects the laser beam around environment being scanned, the iPhone LiDAR doesn't include moving parts. Instead, it consists of thousand lasers on chip providing dedicated laser for each point in the LiDAR's field of view.

Distance measurement of VCSELs LiDAR relies on the time of the flight principle i.e. pulsed VCSEL sends a laser pulse to the object of interest and measure a time a photon is traveling from the laser to object and back to detector providing 3D position.

3. METHODOLOGY

3.1. TLS SURVEY

The study is office for 4 people which are organized in "box" system in order to provide the quit and private space for each employee. Due to that the room is divided with three shelves height 1.6 m. Taking into account the size and shape of the room as well as the position of the furniture (Figure 1) the open traverse scanning strategy was used in this case. In order to capture the complete space three scanning position were needed (Figure 1). The scanner positions were determined by two factors: ability to capture the all details and overlap between individual scans. Each scan is saved in internal coordinate system which origin is located in the center of scanner's mirror. Aligning the multiple individual scans onto a single coordinate system i.e. registration were based on targets. The arrangement of the targets in relation to one another and in relation to the scanner position is critical to the registration process. Three-dimensional, white surveying spheres were used as a target. The target is defined by its position, sphere radius and center point used for registration. The targets were arranged in overlapping scan areas. Additionally, distance from scanner and pattern were analyzed. The maximum distance from scanner is mostly affected by resolution and size of the target. The targets were arranged in unique pattern avoiding straight lines, short distance between targets, and same target height (Figure 1).

The resolution and quality are most important scan parameters affecting the level of detail, the scan duration and ability to register the scene properly. Taking into account the size and environmental conditions of study area resolution was set to 1/8 while quality was set for normal indoor conditions (3x). The point distance was 9 mm while scan duration was 4:08 min. In this case scan with color option was used including the acquisition of color photographs of the scan area.

The collected data were post processed in Faro Scene software. The multiple scenes were aligned by using automatic registration and target-based registration mode. The maximum distance error was 0.6 mm. After registration, project point cloud is created and exported in .las format.

3.2. IPHONE SURVEY

Several apps that enable mapping three-dimensional spaces with LiDAR scanner in iPhone is available in App store. In this case, SiteScape [18] was used. It provide fast way to capture and share 3D scans that can be exported as .RCP, .e57 or PLY files. [18] reported that based on conducted small study, including 9 scans of the same space, measurements are accurate to within ± 1 inch on

average. The app is available into two modes: Free SiteScape and SiteScape Pro. Free SiteScape is limited to one active scan into the cloud at a time while SiteScape Pro unlock unlimited scans in the cloud. Two scan mode are available. Max Area which allows longer scanning time and Max detail for scans that require higher details. Also, it is possible to adjust the point density and point size (apparat size of points while scanning) Since max number of points is limited to 12 million points per scan due to performance constraints the max detail and increase of point density will significantly reduce the area covered per scene. In this case we used Max area mode with medium point density. The distance between device and objects of interest was between 1-4 meters. The scanning time around 10 minutes.

3.3. ACCURACY ASSESSMENT

In order to enable an accurate comparison, both surveys were conducted at same day, one after another providing static scenes without movement of any object. The accuracy of point clouds are firstly tested by measuring object dimension from point cloud in order to test the point cloud scale. For more robust measure of the difference between two surveys the CloudCompare [19] software was used. To test devices capability to determine the area and volume of the room Conure extractor tool was used.

Cloud-to-Cloud tool computes distance between two clouds i.e. for each point within compared point cloud the distance to the reference point cloud wis computed. Different algorithms can be used for quantification of distance between point clouds. Those algorithms can be categorized as global matching algorithms (nearest neighbor distance, nearest neighbor with local modeling) and local-searching algorithm (integrative closest point) [19].

To prepare the point clouds for comparison, it is necessary to check the co-registration of each cloud. This is due to fact that point clouds are available in different coordinate system. The cloud matching technique was used to reduce registration error. Point clouds were firstly co-register using Fine registration tool. The estimated value of RMSE was 12 cm therefore Align tool is used for precise point cloud alignment based on at least three manually identified points which were distributed over study area. The final RMSE was 2.2 cm. Cloud-to-cloud difference were calculated using the C2C implemented in CloudCompare software. TLS point cloud was used as reference.

4. RESULTS AND DISSCUSION

In order to comper the performance of devices the registered Focus M 70 point cloud and iPhone point cloud exported directly from SiteScape were compared.

First, a preliminary data check was performed and the values of the lengths in the points cloud were checked in order to preliminarily verify data and the ability of the device to measure the exact dimensions of well-defined standard objects. In this case, we used five tables which are distributed across the study area (Figure 1.). The true dimensions of tables were checked by using measurement tape. The result of accuracy assessment is presented at Table 2. As results suggest, the Faro Focus M 70 obtained highly accurate results with maximum error of 4 mm, while the accuracy of the iPhone 13 pro is within ± 5 cm. Based on the results it can be conclude that error don't increase with increase of length rather it has random character. Therefore, it can be concluded that scale isn't causing problems and that are most likely coursed by operator ability to define exact boundaries of object. This is expected due to lower density of iPhone point cloud.

Table 2. Compression of object size manually measured from point cloud

True [m]	Faro [m]	iPhone 13 pro [m]	True [m]	Faro [m]	iPhone 13 pro [m]
0.60	0.598	0.583	0.80	0.796	0.789
0.60	0.597	0,579	1.60	1.596	1.648
1.40	1.497	1.385	0.80	0.798	0.807
0.80	0.798	0.776	1.60	1.599	1.584
1.60	1.598	1.646	0.80	0.799	0.790

However, this type of accuracy assessment is highly influenced by operator ability to select exact points as well as point cloud density. In order to gain deeper insight in obtained results cloud-to-cloud comparison was performed. The *cloud couture* tool was used to create horizontal and vertical cross sections of the room (Figure 2). As it can be seen, Focus M 70 cross sections provide almost regular shape of room. The largest deviation of rectangular shape can be noted for vertical profile due to present object which enabled penetration of laser beam. The calculated area was 0.4% higher

than true value, while the perimeter was 5% higher. On another hand, iPhone cross section resulted in irregular room shape due to higher level of noise (Figure 2.). Due to noise level the iPhone floor plan resulting in 8% larger surface area and 21% larger perimeter.

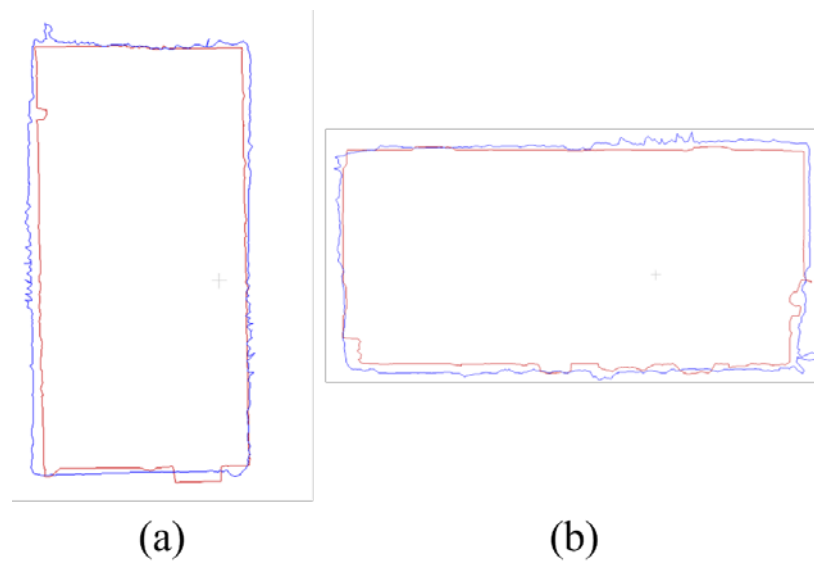

Figure 2. (a) horizontal cross section, (b) vertical cross section. Red line – Focus M70, Blue line – iPhone 13 pro

The distance between the reference (Focus M70) and target (iPhone 13 pro) point cloud was calculate using C2C tools. The spatial distribution of the results of the C2C comparison along axes are shown in Figure 3. Mean absolute difference 6 cm with standard deviation of 10 cm. The largest absolute distance was 1.29 m. However, the visual inspection shows that there is only few point with distance larger that 0.6 m. Those points are result of the noise. Among axis, the largest standard deviation (7 cm) was obtained for X axis (Figure 3).

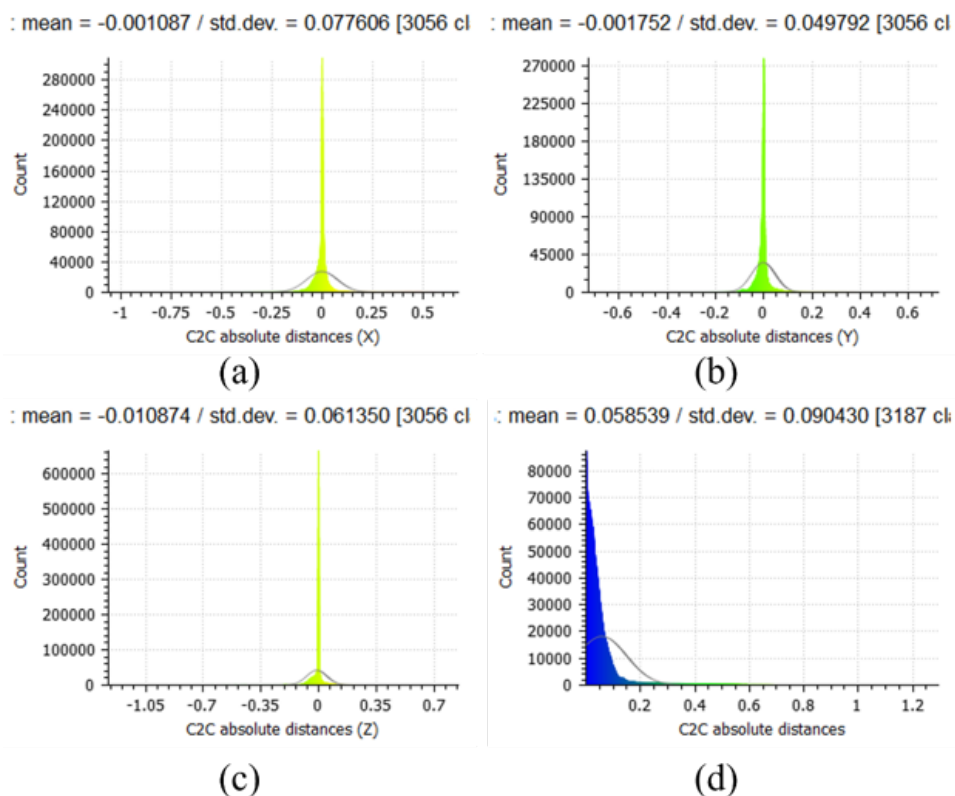

Figure 3. Histogram of point distance distribution (a) along X axis, (b) along Y axis, (c) along Z axis and (d) absolute distance.

Spatial distribution for all axis indicated that the shape of the object doesn't influence iPhone point cloud accuracy i.e. it provide stable performance over flat and curved surfaces (Figure 4). The large difference is presented in the corners (from 0.6 m to 0.15 m) due to holes in Focus M 70-point cloud. The holes in TLS point cloud are usually caused due to limitation scanner vertical field of view and presence of object which enables the penetration of laser beam (purple rectangular).

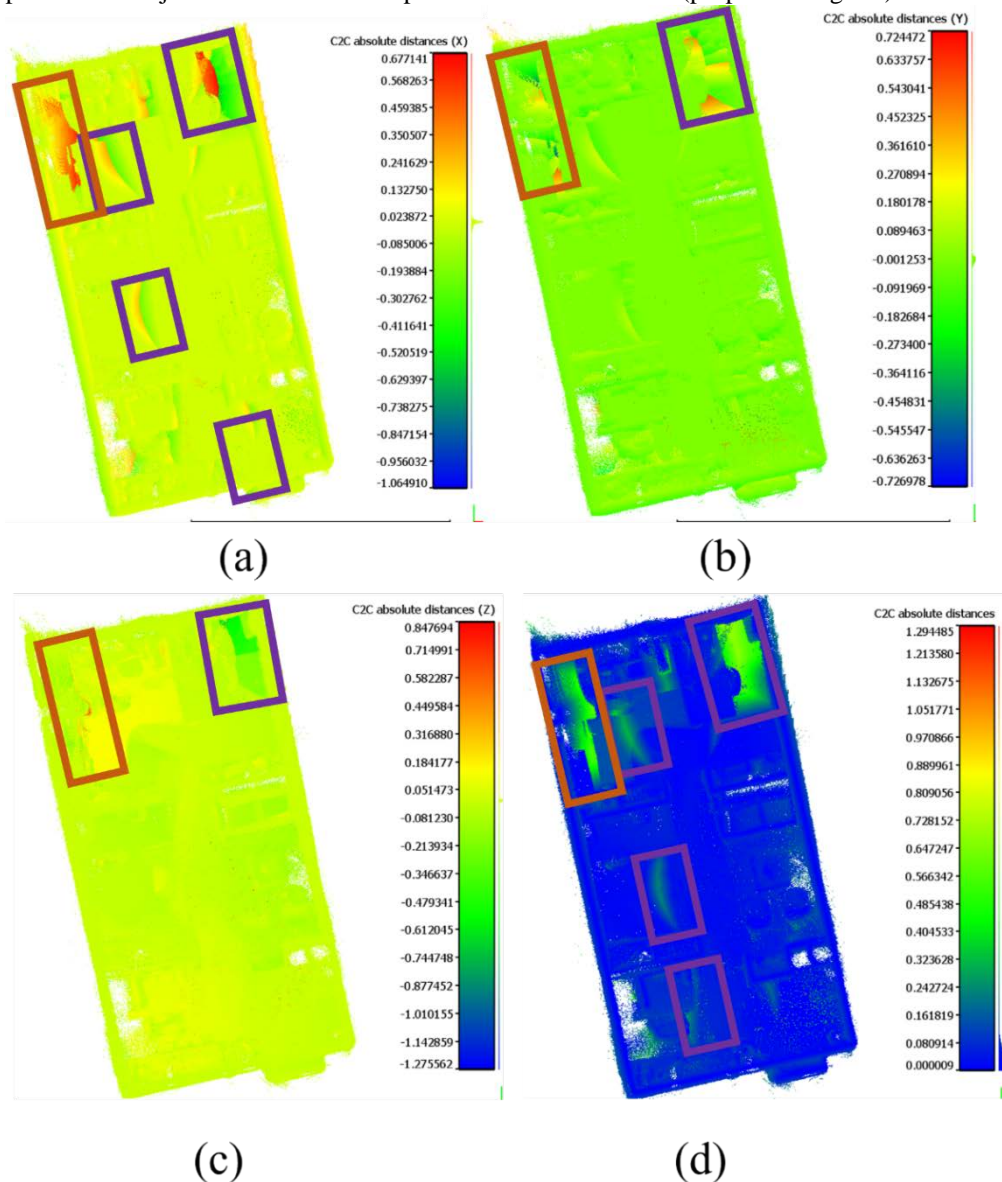

Figure 4. Spatial distribution of absolute distance between point clouds (a) along X axis, (b) along Y axis, (c) along Z axis and (d) absolute distance.

In addition, the large difference (0.6 m to 0.15 m) were caused due to iPhone 13 duplication of the object (orange rectangular). As it can be seen at Figure 5. Plain object such as white wall and black computer near the windows (direct sunlight source) were duplicated. Since looking only a homogeneous object (without clear detail or sharp edges) or noisy object such as carpet, for more than a couple of seconds can caused the iPhone's tracking to drift which will miss-align points [20]. Moreover, high level of noise in iPhone point cloud is caused due to sensor limitations. VCSEL is based on time-of-flight distance measurement, meaning in order to measure distance diode need to ensure that detected photon have been emitted by laser and is not from any other source. Therefore, for the best signal to noise ratio the effect of Ambient light need to be minimized. iPhone VCSEL uses 8xx nm wavelength. Since significant amount of radiation reaching the Earth's surface at 8xx nm the noise level can significantly increase at outdoor or indoor spaces on direct sunlight. Moreover, the TLS illuminate only one pixel at a time resulting much higher power per pixel while

iPhone uses the array VCSEL designs resulting in less power per pixel compared to TLS and therefore larger noise level.

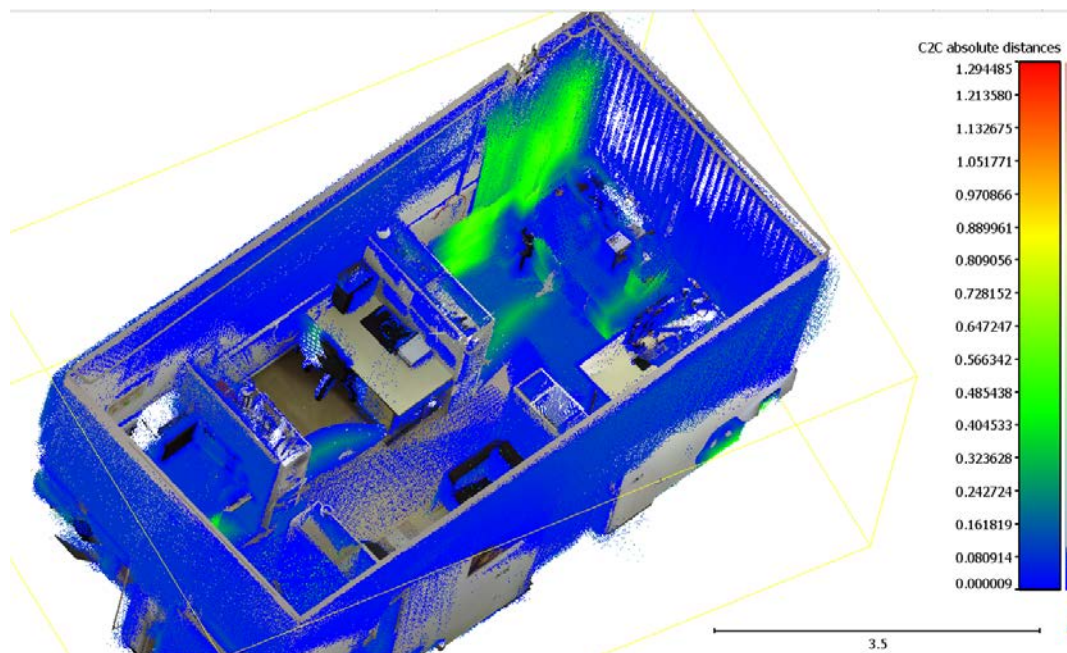

Figure 5. Absolute distance between Focus M70 and iPhone 13 pro

5. CONCLUSION

The increase of demand for accurate 3D indoor models in consumer, industrial and automotive markets, and therefore increasing number of applications incorporating it has led to a significant need for rapid acquisition of point clouds. This paper aims to test customer-level LiDAR devices incorporated in iPhone 13 pro. The results show that iPhone 13 pro provides a scaled point cloud with stable performance over a flat or curved surface. The mean absolute distance between iPhone and the highly accurate TLS point cloud was 9 cm. It provides an accurate point cloud over highly detailed scenes but the level of noise increases over the homogenous object. Moreover, the accuracy of the point cloud is decreased in direct sunlight causing miss-align points and drift effect. In another hand, iPhone represents the full integrated solution that provides rapid point cloud acquisition and direct export of results without post-processing. Due to its compactness and mobility, it enables a survey of hard-to-reach areas eliminating the holes and lack of data. Taking into account the price of the device (1000 vs 27 000 euros) the iPhone 13 pro LiDAR reviles the high potential for rapid, easy-to-use mapping of indoor environment whit sufficient accuracy for modeling.

LITERATURE

- [1] M. Kalantari and M. Nechifor, "Accuracy and utility of the Structure Sensor for collecting 3D indoor information," *Geo-Spat. Inf. Sci.*, vol. 19, pp. 202-209, 2016.
- [2] A. Perez Ramos and G. Robleda Prieto, "3D VIRTUALIZATION BY CLOSE RANGE PHOTOGRAMMETRY INDOOR GOTHIC CHURCH APSES. THE CASE STUDY OF CHURCH OF SAN FRANCISCO IN BETANZOS (LA CORUÑA, SPAIN)," in *The International Archives of the Photogrammetry, Remote Sensing and Spatial Information Sciences*, Avila, Spain, 2015.
- [3] H. El-Din Fawzy, "3D laser scanning and close-range photogrammetry for buildings documentation: A hybrid technique towards a better accuracy," *Alexandria Engineering Journal*, vol. 58, pp. 1191-1204, 2019.
- [4] P. Yu, M. Wang and H. Chen, "Integration and evaluation of SLAM-based backpack mobile mapping system," in *E3S Web of Conference*, Tianjin, China, 2020.
- [5] A. Masiero, F. Fissore, A. Guarnieri, F. Pirotti, D. Visintini and A. Vettore, "Performance Evaluation of Two Indoor Mapping Systems: Low-Cost UWB-Aided Photogrammetry and Backpack Laser Scanning," *Appl. Sci.*, vol. 8, no. 416, 2018.
- [6] J. Wen, C. Qian, J. Tang, H. Liu, W. Ye and X. Fan, "2D LiDAR SLAM back-end optimization with control," *Sensors*, 2018.

- [7] A. Howard, "Multi-robot simultaneous localization and mapping using particle filters," *Int. J. Robot. Res.*, p. 1243–1256, 2006.
- [8] L. Diaz-Vilarino, K. Khoshelham, J. Martiney-Sanchez and P. Arias, "3D Modeling of Building Indoor Spaces and Closed Doors from Imagery and Point Clouds," *Sensors*, vol. 15, no. 2, 2015.
- [9] H. Tan and K. Khoshelham, "Procedural Reconstruction of 3D Indoor Models from Lidar Data Using Reversible Jump Markov Chain Monte Carlo," *Remote Sens.*, vol. 12, pp. 838–864, 2020.
- [10] R. Nowak, R. Orłowicz and R. Rutkowski, "Use of TLS (LiDAR) for Building Diagnostics with the Example of a Historic Building in Karlino," *Building*, vol. 10, no. 24, 2020.
- [11] T. Kersten, K. Mechelke, M. Lindstaedt and H. Sternberg, "Methods for Geometric Accuracy Investigations of Terrestrial Laser Scanning Systems.," *Photogramm. Fernerkund. Geoinf.*, pp. 301–315, 2009.
- [12] M. Ingman, J. Virtanen, M. Vaaja and H. A. Hyypä, "Comparison of Low-Cost Sensor Systems in Automatic Cloud-Based Indoor," *Remote Sens.*, 2020.
- [13] J. Hullo, P. Grussenmeyer, T. Landes and G. Thibault, "Georeferencing Of Tls Data For Industrial Indoor Complex Scenes: Beyond," in *In Proceedings of the ISPRS Calgary 2011 Workshop on International Archives of the Photogrammetry, Calgary, Canada.*, 2011.
- [14] M. Zollhofer, P. Stotko, A. Gorlitz, C. Theobalt, M. Niebner, R. Klein and A. Kolb, "State of the art on 3d reconstruction with RGB-D cameras," *Comput. Graph. Forum*, vol. 37, no. 2, pp. 625–652, 2018.
- [15] P. Hubner, S. Landgraf, M. Weinmann and Wursthorn, "Evaluation of the Microsoft HoloLens for the Mapping of Indoor Building Environments," in *Dreiländertagung der DGPF, der OVG und der SGPF, Wien*, 2019.
- [16] M. Weinmann, M. Amelie Jager, S. Wursthorn, B. Jutzi, M. Weinman and P. Hubner, "3D INDOOR MAPPING WITH THE MICROSOFT HOLOLENS: QUALITATIVE AND QUANTITATIVE EVALUATION BY MEANS OF GEOMETRIC FEATURES," in *ISPRS Annals of the Photogrammetry, Remote Sensing and Spatial Information Sciences.*, 2020.
- [17] H. Moench, M. Carpaij, P. Gerlach, S. Gronenborn, R. Gudde, J. Hellming, J. Kolb and A. van der Lee, "VCSEL-based sensors for distance and velocity," in *Vertical-Cavity Surface-Emitting Lasers XX; , San Francisco, California, United States*, 2016.
- [18] "SiteScape," [Online]. Available: <https://www.sitescape.ai/>. [Accessed 10 03 2022].
- [19] C. Compare, "Cloud Compare," [Online]. Available: https://www.cloudcompare.org/doc/wiki/index.php?title=Cloud-to-Cloud_Distance#:~:text=When%20no%20local%20model%20is,surface%20represented%20by%20the%20cloud.. [Accessed 10 03 2022].
- [20] SiteScape, "SiteScape User Guid," SiteScape, [Online]. Available: <https://docs.google.com/document/d/10xX5BYJpjdXgjOox3NFVhiOmGZPeTeagaarjf7D8lQ/edit#>. [Accessed 10 03 2022].
- [21] H. Moench, M. Capraij, P. Gerlach, S. Gronenborn, R. Gudde, J. Hellming, J. Kolb and A. Lee, "VCSEL based sensors for distance and velocity," in *Proc. SPIE 9766, Vertical-Cavity, San Francisco, California, United States*, 2016.



Miljana Todorović Drakul, University of Belgrade, mtodorovic@grf.bg.ac.rs

Sanja Grekulović, University of Belgrade, sanjag@grf.bg.ac.rs

Oleg Odalović, University of Belgrade, odalovic@grf.bg.ac.rs

Dušan Petković, University of Belgrade, dpetkovic@grf.bg.ac.rs

COMPARISON OF IRI-2016 AND NEQUICK MODELS OF THE IONOSPHERE OVER THE BALKAN PENINSULA DURING THE YEAR 2019

Abstract

In this paper, a comparative study of the total vertical electron content (VTEC) calculated using the IRI-2016 and NeQuick2 models were performed. The research was done for the days of maximum solar activity in 2019, with data from seven IGS GNSS stations in the region of the Balkan Peninsula. The results show that both models agree quite well with the observed VTEC values obtained from GNSS measurements at all stations, although with some offset observed during several days at different times. The IRI-2016 model performed better than the NeQuick2 model most of the days and stations for which the NeQuick model overestimates the GNSS VTEC. The results show that the NeQuick model gives better quality values in some cases, but for isolated instances.

Keywords: ionosphere, GNSS, IRI-2016, NeQuick

ПОРЕЂЕЊЕ IRI-2016 И NEQUICK МОДЕЛА ЈОНОФЕРЕ ИЗНАД БАЛКАНСКОГ ПОЛУОСТРВА ТОКОМ 2019. ГОДИНЕ

Сажетак

У овом раду вршена је упоредна студија вредности укупног вертикалног садржаја електрона (VTEC) сачунао коришћењем IRI-2016 и NeQuick2 модела. Истраживање је рађено за дане максималне соларне активности током 2019. године са подацима са седам ИГС ГНС станица у региону Балканског полуострва. Резултати показују да се оба модела прилично добро слажу са вредностима VTEC добијеним из ГНС мерења на свим станицама, иако са извесним неслагањима уоченим током неколико дана у различитим временским интервалима. Модел IRI-2016 је показао боље перформансе од NeQuick2 модела за већину тестираних периода и већину станица за које NeQuick2 прецењује ГНС VTEC вредности. Резултати показују да NeQuick2 модел даје вредности бољег квалитета, али само у ограниченом броју случајева.

Кључне ријечи: јоносфера, ГНС, IRI-2016, NeQuick

1. INTRODUCTION

The ionosphere is an area of the Earth's atmosphere and extends at an altitude of about 60 km to 2000 km. According to the distribution of electron density depending on altitude, the ionosphere can be divided into four layers D (60-90 km), E (90-140 km), F1 (140-210 km), and F2 (over 210 km). The significant presence of electrons in the ionosphere directly affects electromagnetic waves by changing their direction and speed and adversely affects radio communication and navigation, aviation, and the Global Navigation Satellite System (GNSS).

Therefore, it is necessary to determine the spatial distribution of electrons in the ionosphere precisely. One of the important parameters used to characterize the ionosphere is the Total Electron Content (TEC) defined by the number of electrons integrated between two points along a tube of unit cross-sectional area. TEC is expressed in TECU units, where $1 \text{ TECU} = 10^{16}$ electrons/m². Based on the multitude of ionospheric data from GNSS satellites, along with the need for accurate navigation, various models of the ionosphere have been established that provide predictions of ionospheric TEC where actual data are absent. In this context, the comparison of the performance of two empirical models to predict of ionosphere parameters, with an accent on TEC values, is the subject of this paper. These are the International Reference Ionosphere (IRI) and NeQuick models. GNSS measurements were used to validate the IRI and NeQuick models, and VTEC values were calculated from RINEX (Receiver Independent Exchange) files for seven IGS stations in the Balkan Peninsula.

The International Reference Ionosphere (IRI) is an international project sponsored by the Committee on Space Research (COSPAR) and the International Union of Radio Science (URSI). In the late 1960s, a working group was formed to establish a global empirical model based on all available data sources at the time [1]. Since 1978 [2], when the model was implemented, several improved versions have been released, including IRI-1990, IRI-2000, IRI 2007 and IRI-2012. IRI-2016 is the current version. The IRI model is based on a large amount of ground-based and space-based observational data, mainly from satellites, incoherent scattering radars, and altimeters [3]. The input variables of the IRI model include date, coordinates, solar index, ionospheric index, and magnetic index. The height range of the electron density is 65–2000 km day time and 80–2000 km night time. The model provides ionospheric variables, e.g., monthly average electron density, electron temperature, ion temperature, ion composition, etc. [3].

The NeQuick model is a time-dependent, three-dimensional ionospheric electron density model. This model was developed at the International Center for Theoretical Physics (ICTP) in Trieste, Italy, and at the University of Graz, Austria for the Galileo satellite system to calculate ionospheric delay corrections for single-frequency users [4]. The model is divided into lower and upper models. Input variables are geocentric latitude, geocentric length, altitude, universal time (UT) and solar activity (given a monthly mean sunspots number R12 or 10.7 cm solar radio flux of F10.7). The NeQuick provides services to evaluate the electron density along any ground to satellite, straight line ray path and the corresponding TEC by numerical integration. The NeQuick model includes two versions of NeQuick1 and NeQuick2 [5]. The NeQuick2 version was used in this paper.

Many authors have made performance comparisons of the ionospheric models so far, both for the global and local areas. The accuracy of the model during the period of calm and medium solar activity at the global level [6], in the Antarctic region [7], at equatorial and low latitudes [8], etc. was examined. In this context, this paper aims to analyze the performance of both ionosphere models by focusing on the Balkans. To achieve that, a couple of stations in the area of the Balkan Peninsula were chosen for the period during 2019 for the days for which increased solar activity was observed.

2. DATA AND METHODOLOGY

2.1. SOLAR AND MAGNETIC CONDITIONS

Changes in the ionosphere, and therefore TEC's value, largely depend on geomagnetic and solar activity.

The essential parameter of geomagnetic activity is the A_p index. The A_p -index provides a daily average level for planetary magnetic activity, with units of 2nT. Definitive values of A_p are provided by GeoForschungsZentrum (GFZ) Potsdam, Adolf-Schmidt-Observatorium für Geomagnetismus, Niemeck, Germany on behalf of the International Service of Geomagnetic Indices (ISGI) of the International Association of Geomagnetism and Aeronomy (IAGA).

The sunspot number index R_n measures the area of solar surface covered by spots. As the number of spots increases and their magnetic complexity grows, they become likely sources of sizeable

eruptive energy releases known as solar flares, directly affecting the ionosphere. Besides daily, monthly, and yearly averages, a 12-month running mean value, R_{12} (Rn), is calculated. Since 1981 an International Sunspot Number Ri been derived by A. Koeckelenbergh at the World Data Center C for Sunspots in Brussels, Belgium. Analyzing the long record of observations, it has been found that the cycle period varies from ten to 12 years with a mean of 11 years. Cycles are numbered chronologically. Solar Cycle 25 began in December 2019, so the year 2019 belongs to cycle 24. The 10.7 cm solar radio flux, or $F_{10.7}$ is, along with sunspot number, one of the most widely used indices of solar activity. It measures the noise level generated by the sun at a wavelength of 10.7 cm at the Earth's orbit. The global daily value of this index is measured at local noon at the Dominion Radio Astrophysical Observatory (DRAO) in Penticton, Canada.

Figure 1 shows the parameters Ap , Rn and $F10.7$ for the year 2019.

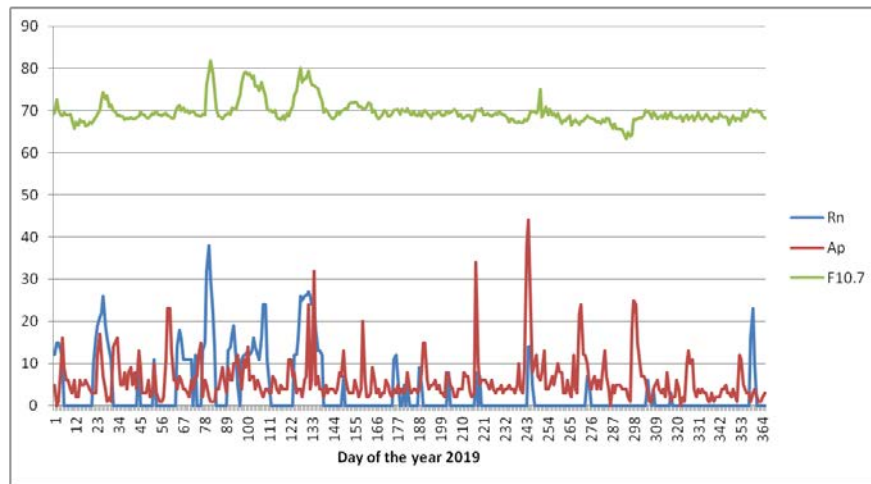

Figure 1. Parameters Ap , Rn and $F10.7$ for year 2019

2.2. DATA DESCRIPTION

The observational data used in this study were the dual-frequency observational data from GNSS stations in the Balkan Peninsula and the surrounding areas. These stations include five IGS stations in the Balkans and two stations outside, of which one is in Austria and the other in Hungary. Stations in Austria and Hungary were chosen to cover the northern part of the peninsula. The distribution of all these stations is shown in Figure 2 and the detailed coordinates are provided in Table 1.

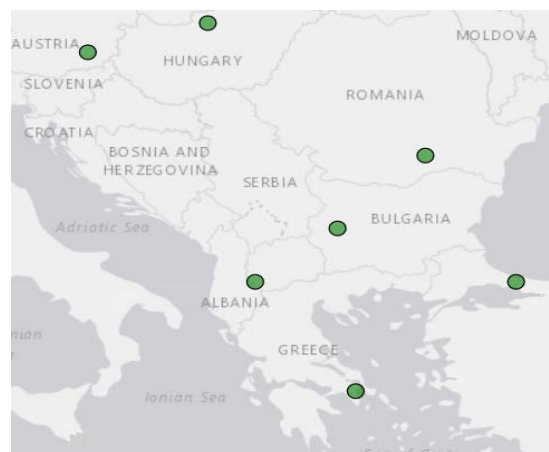

Figure 2. Distribution of GNSS points

The observational data were collected in January, March, April, May, September and December 2019, for days for which enhanced solar and geomagnetic activity has been observed. The dates for which testing was performed are shown in Table 2.

Table 1. Coordinates of IGS GNSS stations considered in this study

Station	Latitude	Longitude	Height
GRAZ00AUT	47.067	15.493	538.3
PENC00HUN	47.790	19.282	291.7
BUCU00ROU	44.464	26.126	143.2
SOFI00BGR	42.556	23.395	1119.6
ORID00MKD	41.127	20.794	773.0
DYNG00GRC	38.079	23.932	510.6
ISTA00TUR	41.104	29.019	147.2

Table 2. Days of the month for which the data were collected

Month	Day of the month
January	24, 25
March	21, 22
April	18, 19
May	11, 13, 14
September	1
December	25

2.3. GNSS VTEC

The RINEX (Receiver Independent Exchange) format observation files obtained for the years 2019 from seven GNSS receivers stationed at different locations (Table1). To get the VTEC_{GNSS}, RINEX files are processed using the GPS-TEC analysis application software version 3 developed by Gopi Seemala of the Institute for Scientific Research, Boston College, USA [9].

This software calculates GNSS TEC based on the principle that the dual frequency GNSS receivers use L₁ (1575.42 MHz) and L₂ (1227.60 MHz) to derive TEC using differential delay technique. The ionospheric time delay at the L₁ carrier frequency of f₁ is:

$$t_1 = 40.3 \left(\frac{TEC}{c \cdot f_1^2} \right) \quad (1)$$

where C is the speed of light. The difference in the time delay between L₁ and L₂ frequencies, is given by

$$\Delta t_1 = \left(\frac{40.3}{c} \right) \times \left(\frac{TEC}{f_1^2 - f_2^2} \right) \quad (2)$$

where $\Delta t = t_2 - t_1$. The above calculated TEC is slant TEC (STEC), and the accuracy of absolute TEC measurements can be improved with differential phase measurements. Vertical TEC (VTEC) can be calculated as:

$$VTEC = \frac{STEC - b_r - b_s}{S(E)} \quad (3)$$

where b_r is the receiver bias, b_s is the satellite bias and $S(E)$ is mapping function, which is defined as

$$S(E) = \frac{1}{\cos(Z)} = \left[1 - \left(\frac{R_E \cos(E)}{R_E + h_s} \right)^2 \right]^{-\frac{1}{2}} \quad (4)$$

where Z is the zenith angle of the satellite as seen from the observing station, R_E is the radius of the Earth, E is the elevation angle, and h_s is the ionospheric effective height above the Earth's surface which is taken as 350 km.

2.4. IRI – 2016

The IRI model has been developed to specification ionospheric parameters supported by the Committee on Space Research and the International Union of Radio Science (URSI). A team of international experts continuously improves it as the new data becomes available. IRI model

describes the electron density, temperature, composition, and TEC for a given location, time, and date. The version of this model IRI-2016 includes two new model options for the F2 peak height $hmF2$ and a better representation of topside ion densities at very low and high solar activities. In addition, a number of minor changes were made concerning the use of solar indices and the speedup of the computer program. In this paper, the calculation of daily $VTEC_{IRI-2016}$ values on a sample of 1 min was performed.

A detailed description of the IRI-R016 can be found in [3].

2.5. NEQUICK2

The NeQuick model is a time-dependent, three-dimensional ionospheric electron density model. He reproduces the electron density distribution in the ionosphere analytically based on a model introduced by Di Giovanni and Radicella (DGR model) [9]. Recently, much effort has been made to improve the existing model, given the increasing data availability. Therefore, versions of the NeQuick2 model were obtained. The changes that have been made are related to the parameter for defining the bottom side and topside. Five Semi-Epstein layers were used with modeled thickness parameter for description of the ionosphere's electron density above 90 km and up to a peak of the F2 layer. A one-minute calculation period was chosen to obtain the $VTEC_{NeQuick}$ value in this paper. Details of the NeQuick2 model analytical formulation can be found in [10].

2.6. COMPARISON OF DIFFERENT MODELS

To investigate the accuracy of the IRI-2016 and NeQuick2, in this study, the difference and its absolute value between the $VTEC_{GNSS}$ and the modeling VTEC ($VTEC_{IRI-2016}$ or $VTEC_{NeQuick}$) were computed, as shown in Equation (5) and (6).

$$\Delta VTEC_{IRI-2016} = VTEC_{IRI-2016} - VTEC_{GNSS} \quad (5)$$

$$\Delta VTEC_{NeQuick2} = VTEC_{NeQuick2} - VTEC_{GNSS} \quad (6)$$

We compute the Root Mean Square Deviation (RMSD) of the IRI-2016, NeQuick2 and the of both models using Equations (7) and (8)

$$RMS\Delta = \sqrt{\frac{\sum_1^n (\Delta VTEC_{IRI-2016})^2}{n}} \quad (7)$$

$$RMS\Delta = \sqrt{\frac{\sum_1^n (\Delta VTEC_{NeQuick2})^2}{n}} \quad (8)$$

where n is the number of data.

3. RESULTS AND ANALYSIS

Daily VTEC variations from the GNSS, IRI-2016 and NeQuick2 models were performed for all seven stations during typical 2019 days. These are the days for which increased solar activity was observed concerning the indices A_p , R_n and $F10.7$. The results are presented in Figures 3, 4, 5 and 6. Green curves represent daily values of VTEC variations measured by GNSS, red curves represent NeQuick2 variations of VTEC derived from the model, and blue curves represent VTEC variations based on the IRI-2016 model. From all these diagrams, it is clear that the daily variation of VTEC shows lower values at night, with a gradual increase in the morning, so that the maximum values appear between 10 and 14 (UT) hours. After that, the VTEC values gradually decrease towards the evening hours, where the minimum occurs between 1 and 4 hours (UT). The maximum values of VTEC were detected on January 24, 2019. and May 25, 2019. Values amount from 8 to 18 TECU for 11.05. (12 UT) and from 9 to 14 TECU for 14.05. (10 UT). For the day 25.12. which has the most negligible fluctuations in the ionosphere of the selected days, all ststions have daily VTEC variations ranging from 1.5 to 7.5 TECU (Figure 4).

The daily TEC variations derived from the IRI-2016 and NeQuick2 models follow all the above characteristics with a difference of about 0.5 to 7 units of total electron content (TECU) (1 TECU = 10^{16}el/m^2) compared to $VTEC_{GNSS}$. Figures 7, 8 and 9 show the differences between the modeled and GNSS values of VTEC at all seven stations for the selected days and time during 2019. Data were selected at moments when the maximum VTEC values were obtained. The most significant differences are observed during the maximum of daily solar activity in the period between 9 and 14 UT for all stations and both models. The differences go up to 8 TECU.

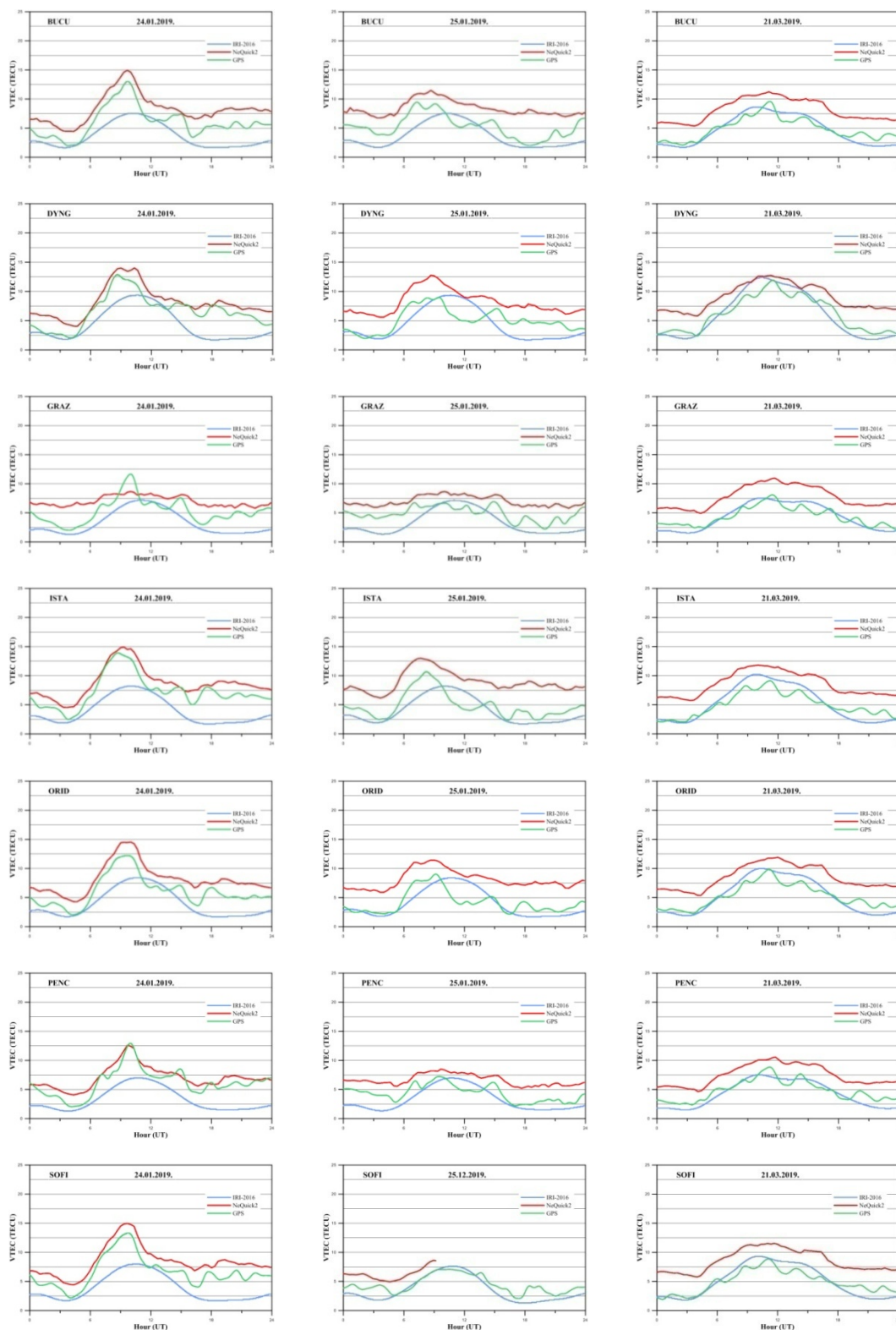

Figure 3. Daily variation of VTEC values for GNSS (green line), IRI-2016 (blue line) and NeQuick2 (red line) during 24.01., 25.01. and 21.03. 2019.

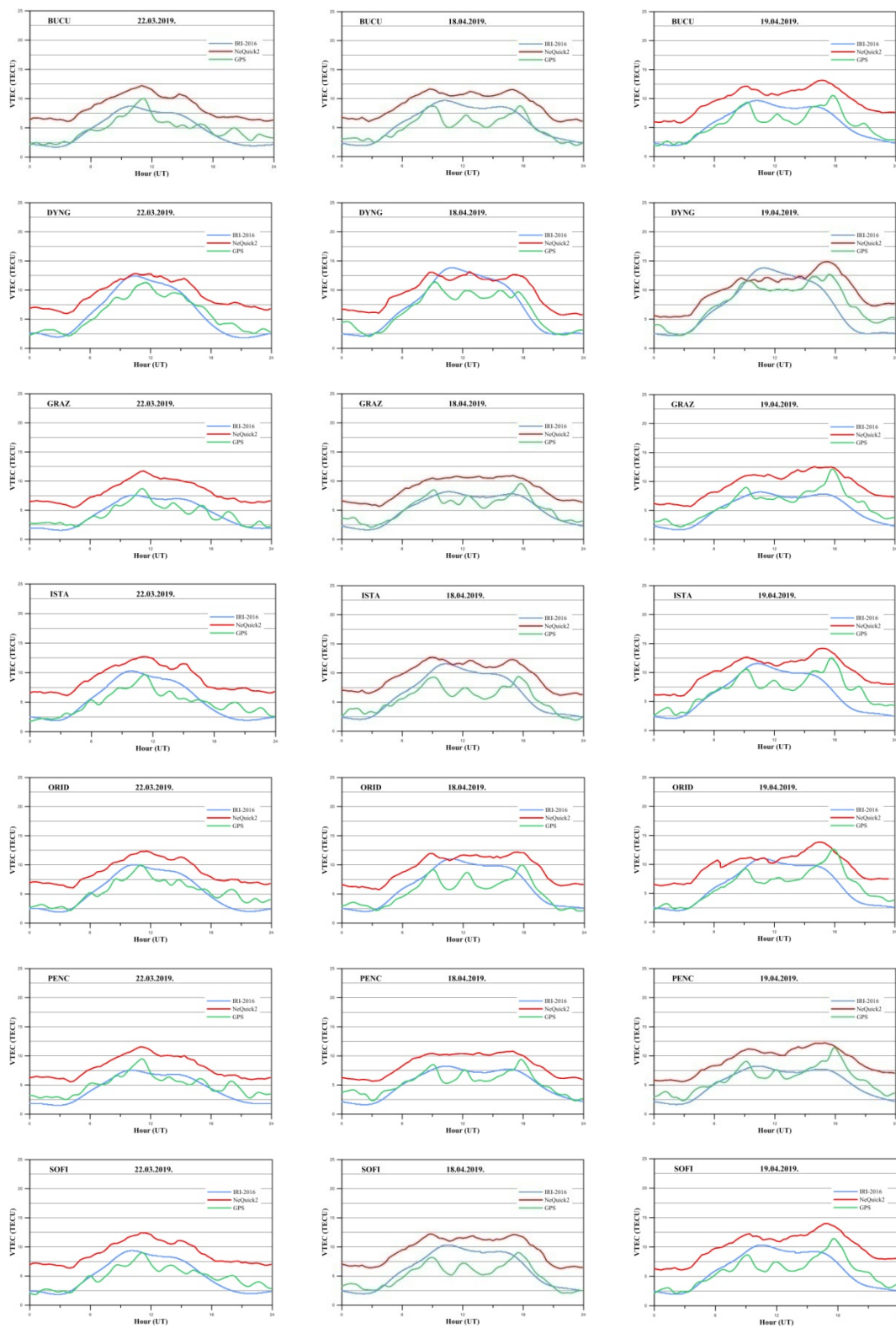

Figure 4. Daily variation of VTEC values for GNSS (green line), IRI-2016 (blue line) and NeQuick2 (red line) during 22.03., 18.04. and 19.04. 2019.

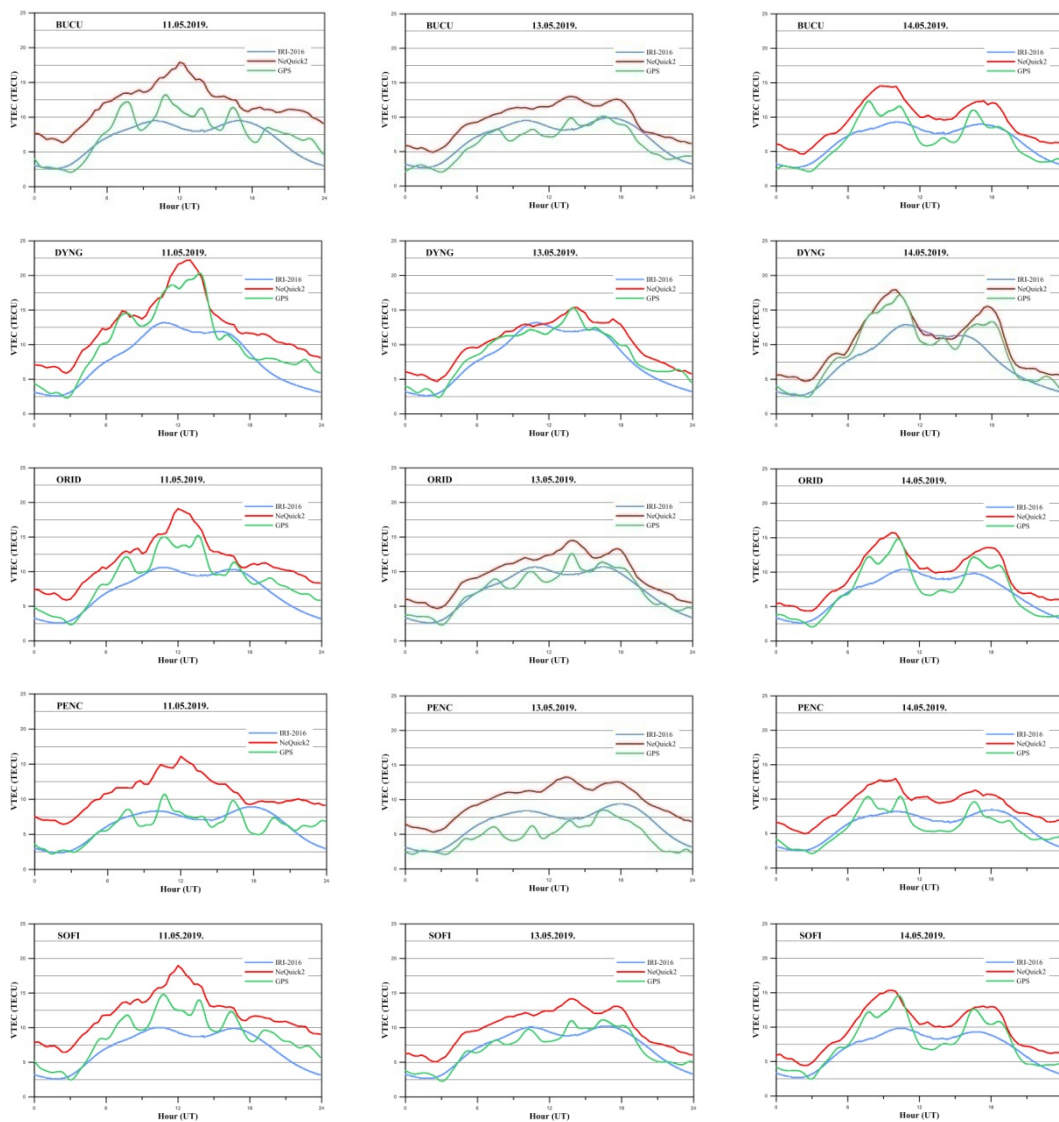

Figure 5. Daily variation of VTEC values for GNSS (green line), IRI-2016 (blue line) and NeQuick2 (red line) during 11.05., 13.05. and 14.05. 2019

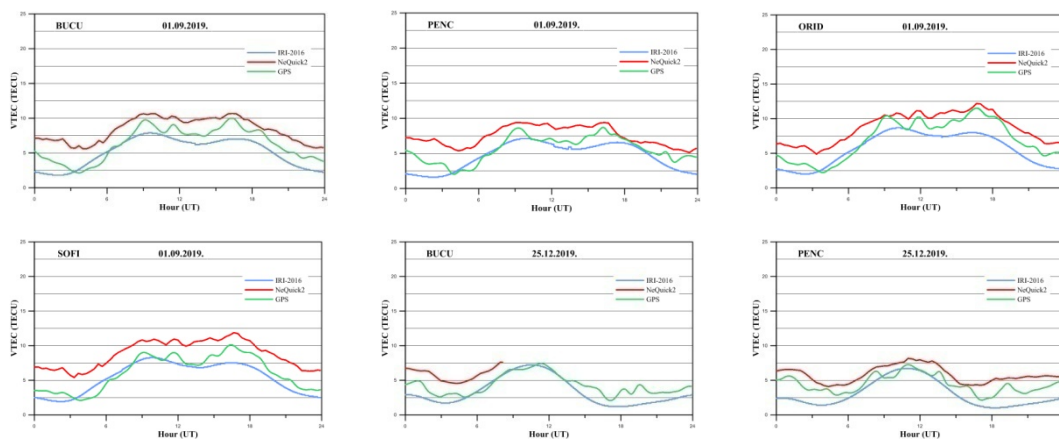

Figure 6. Daily variation of VTEC values for GNSS (green line), IRI-2012 (blue line) and NeQuick2 (red line) during 01.09. and 25.12. 2019.

The VTEC values derived from the IRI-2016 and NeQuick model show more significant differences for the days of intensified solar activity, for example, during April and May 2019, while during other periods, they follow the $VTEC_{GNSS}$ values quite well. The VTEC values from these two models are almost similar for all stations during all test periods. It is interesting to note that for the day 24.01. generally, the VTEC values derived from the NeQuick2 model and obtained from GNSS measurements match quite well (maximum difference of about 2.5 TECU at all locations). In comparison, the values from the IRI-2016 model deviate significantly (about 7 TECU). Also, it was noticed that the values of $VTEC_{GNSS}$ and $VTEC_{IRI-2016}$ match quite well for all other days, and that the values of $VTEC_{NeQuick}$ generally for all days and all stations (except for January 24) have higher values than $VTEC_{IRI-2016}$ and $VTEC_{GNSS}$.

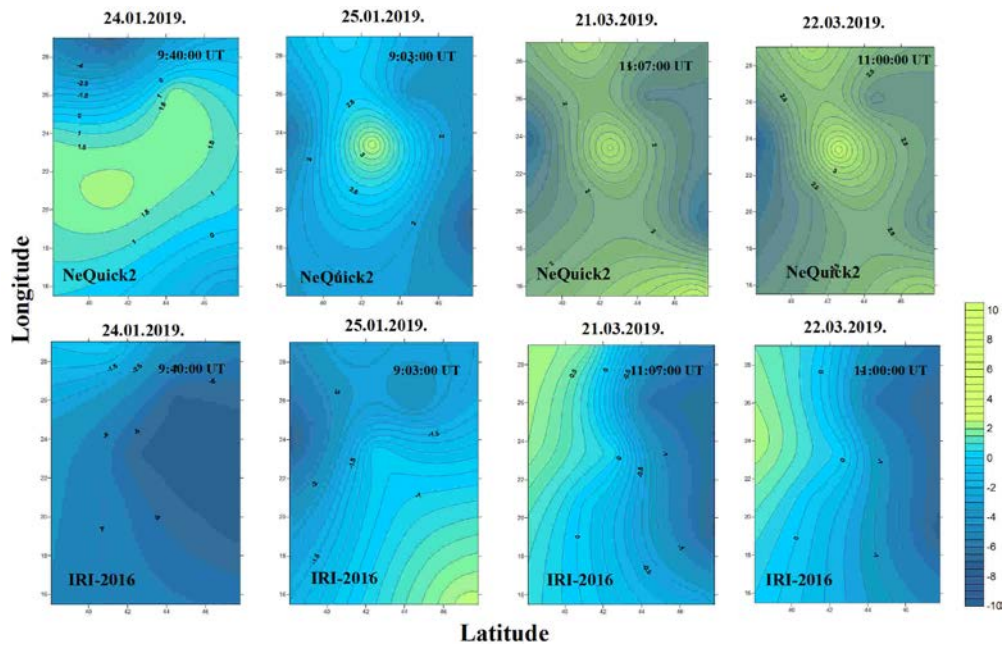

Figure 7. Distribution of differences between the $VTEC_{GNSS}$ and modeled VTEC ($VTEC_{IRI-2016}$ and $VTEC_{NeQuick2}$) during 24.01., 25.01., 21.03. and 22.03. 2019.

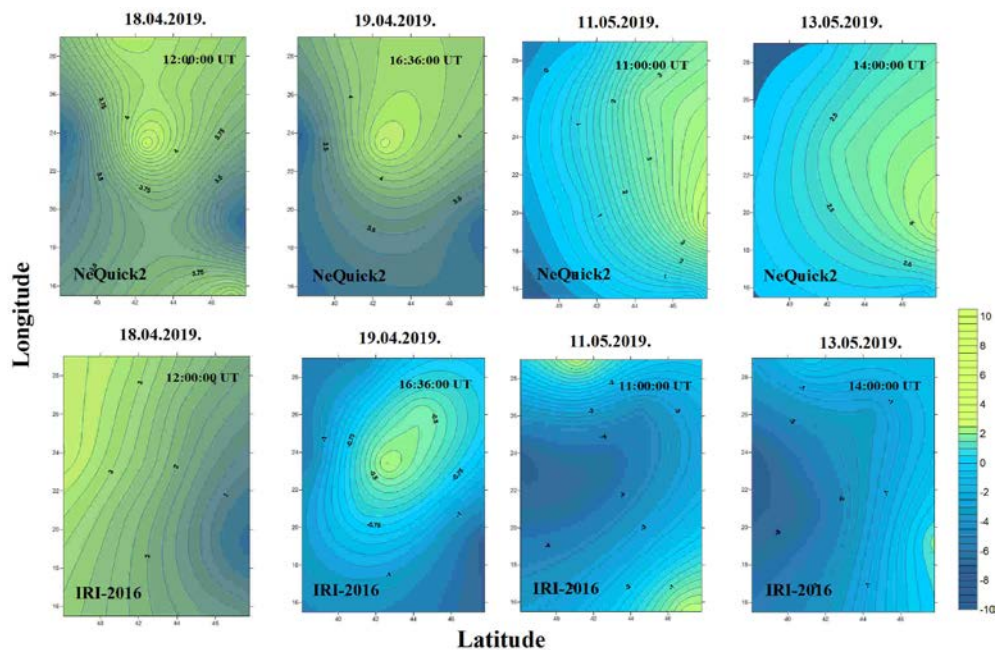

Figure 8. Distribution of differences between the $VTEC_{GNSS}$ and modeled VTEC ($VTEC_{IRI-2016}$ and $VTEC_{NeQuick2}$) during 18.04., 19.04., 11.05. and 13.05. 2019.

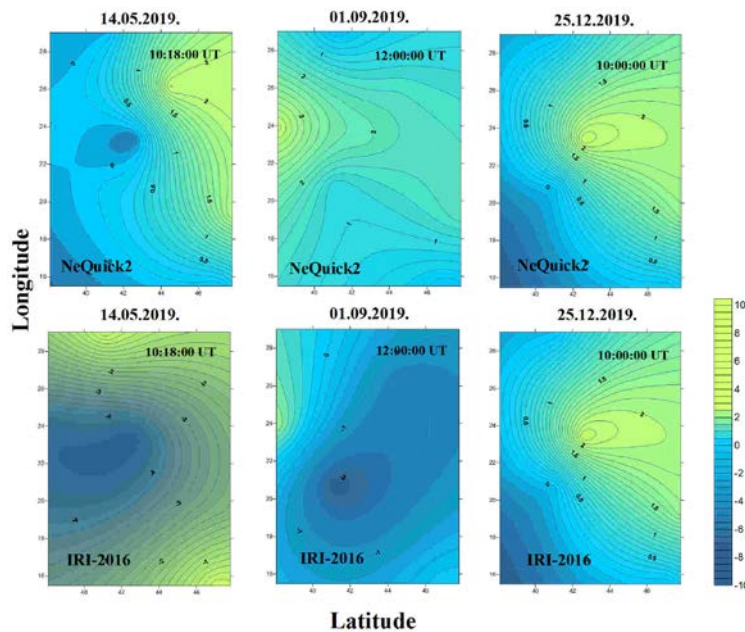

Figure 9. Distribution of differences between the $VTEC_{GNSS}$ and modeled VTEC ($VTEC_{IRI-2016}$ and $VTEC_{NeQuick2}$) during 14.05., 01.09., and 25.12. 2019.

Table 3 presents the estimated RMSE VTEC in TECU unit for seven stations, considering the results of the eleven processed days of year 2019. and the two ionospheric approaches: IRI-2016 and NeQuick2. Analyzing the data, it can be noticed that both models have approximate values and that their performance is therefore satisfactory. Although, it can be concluded that IRI-2016 gives slightly better results, because the value of RMSD is not higher than 2.03 for any station.

Table 3. RMSD of the $VTEC_{IRI-2016}$ and $VTEC_{NeQuick2}$ values from the different stations during 2019

Station	Model	Number of valus	Min (TECU)	Max (TECU)	RMSD (TECU)
BUCU	IRI-2016	15774	-5.6	4.62	1.82
	NeQuick2	14889	0.28	7.05	1.09
DYNG	IRI-2016	15840	-8.50	5.44	2.01
	NeQuick2	15840	-8.80	4.62	2.32
GRAZ	IRI-2016	8640	-5.99	2.40	1.42
	NeQuick2	8640	-3.00	5.47	1.17
ISTA	IRI-2016	11517	-6.37	5.48	2.03
	NeQuick2	11517	-10.5	9.08	3.82
ORID	IRI-2016	15799	-5.80	5.26	1.77
	NeQuick2	15799	-7.18	5.61	2.14
PENC	IRI-2016	15837	-6.94	4.14	1.63
	NeQuick2	15837	-1.26	7.98	1.49
SOFI	IRI-2016	14949	-5.97	5.12	1.81
	NeQuick2	14949	-0.51	6.47	1.23

4. CONCLUSIONS

In this paper, we have investigated the performance of the IRI- 2016 and NeQuick2 model to predict the GNSS VTEC for seven selected GNSS stations located in the Balkan peninsula during 2019. The results from this study show that the VTEC predicted by both models agrees quite well with the observed GNSS VTEC measurements, although with some offset observed during several days at different times. The IRI-2016 model performed better than the NeQuick2 model most of the days and stations for which the NeQuick model overestimates the GNSS VTEC. The results show that

the Neckick model gives better quality values in some cases, but this does not apply to all days or to all stations. Since GNSS VTEC are greater during equinoxes than in the solstice seasons and since the differences in VTEC values from both models depend on local time, latitude, and solar activity, it is necessary to take these parameters into account when modeling VTEC values. To obtain a realistic evaluation of the quality of these two models, it is necessary to perform further analyzes. The plan is to expand the research to more time periods including days of intensified and days of quiet solar activity over several years, and to consider the influence of station latitude.

LITERATURE

- [1] D. Bilitza, "International Reference Ionosphere 2000," *Radio Science*, vol. 36, pp. 261-75, 2000.
- [2] K. Rawer, S. Ramakrishnan, and D. Bilitza, "International Reference Ionosphere 1978. - Special Report," International Union of Radio Science, Brussels, 1978.
- [3] Bilitza, et al., " International Reference Ionosphere 2016: From ionospheric climate to real-time weather predictions," *Space weather*, vol.15, pp. 418-429, 2017.
- [4] Angrisano, S. Gaglione, C. Gioia, "Assessment of NeQuick ionospheric model for Galileo single-frequency users," *Acta Geophys*, vol. 61, pp. 1457-1476, 2013.
- [5] European Commission, "European GNSS (Galileo) Open Service-Ionospheric Correction Algorithm for Galileo Single Frequency Users," European Commission Brussels, Belgium, vol.1.2, pp. 1-96, 2016.
- [6] Cherniak, I. Zakharenkova, "NeQuick and IRI-Plas model performance on topside electron content representation: Spaceborne GPS measurements," *Radio Science*, vol. 51, pp. 752-766, 2016.
- [7] Z. Guo, Y. Yao, J. Kong, G. Chen, C. Zhou, Q. Zhang, L. Shan, C. Liu, "Accuracy Analysis of International Reference Ionosphere 2016 and NeQuick2 in the Antarctic," *Sensors*, vol. 21, pp. 1551, 2021.
- [8] K. Venkatesh, P. R. Fagundes, G. K. Seemala, "On the performance of the IRI-2012 and NeQuick2 models during the increasing phase of the unusual 24th solar cycle in the Brazilian equatorial and low-latitude sectors," *Journal of Geophysical Research: Space Physics*, vol. 119, pp. 5087-5105, 2014.
- [9] G. K. Seemala, "GPS-TEC Analysis Application," Institute for Scientific Research, Boston College, USA. 2014.
- [10] Nava, P. Coisson, and S. M. Radicella, "A new version of the NeQuick ionosphere electron density model," *Journal of atmospheric and solar-terrestrial physics*, vol. 70, pp. 1856-1862, 2018.



Slavica Ilijević, University of Belgrade, slavica.ilijevic3@gmail.com
Stefan Miljković, University of Belgrade, stefan.miljkovic@geopot.com
Željko Cvijetinić, University of Belgrade, zeljkoc@grf.bg.ac.rs
Mileva Samardžić-Petrović, University of Belgrade, mimas@grf.bg.ac.rs

MOBILE LASER SCANNING FOR DETAILED DIGITAL TOPOGRAPHIC MAPPING

Abstract

Mobile Laser Scanning (MLS) is a technique characterized by high data acquisition efficiency and level of detail. However, a lot of information contained in the LiDAR point cloud is only implicitly available. Therefore, in order to create a digital topographic map from a large quantity of MLS survey data, it is necessary to define a methodology that requires a combination of various software tools. In general, the applied methodology mainly depends on the final product specifications (data model, accuracy, level of detail, etc.). This paper describes the standard methodology of creating a detailed digital topographic map using data collected by MLS, which proved to be two times faster than the conventional methods (total station or GNSS survey).

Keywords: mobile laser scanning, digital topographic map, point cloud

МОБИЛНО ЛАСЕРСКО СКЕНИРАЊЕ ЗА ДЕТАЉНО ДИГИТАЛНО ТОПОГРАФСКО КАРТИРАЊЕ

Сажетак

Мобилно ласерско скенирање (МЛС) је техника коју карактерише висока ефикасност прикупљања података и висок ниво детаљности. Међутим, велика количина информација садржана у LiDAR облаку тачака је само имплицитно дата. Стога, да би се израдио дигитални топографски план на основу велике количине МЛС података, потребно је да се дефинише методологија која захтева комбинацију различитих софтверских алата. Генерално, примењена методологија углавном зависи од спецификација коначног производа (модел података, тачност, ниво детаљности, итд.) У овом раду описана је стандардна методологија израде крупноразмерног дигиталног геодетског плана коришћењем података добијених МЛС-ом која се показала дупло бржа од конвенционалних метода мерења (ГНСС премер или тотална станица).

Кључне ријечи: мобилно ласерско скенирање, дигитални топографски план, облак тачака

1. INTRODUCTION

Advances in technology and surveying techniques make it possible to obtain a large amount of data in a short time. Light Detection and Ranging (LiDAR), also known as laser scanning or 3D scanning, is one of the remote sensing methods with a rapid development and wide applications in the last two decades. The method is based on collecting extremely large amount of spatial data in the form of point clouds, a set of closely spaced three-dimensional points (X, Y, Z). The data collected by laser scanners enable detailed representation of various objects and phenomena, such as terrain, vegetation, transmission lines, buildings, streets, elements of traffic markings and signs, and other objects and surfaces. Depending on the platform it uses, laser scanning method is divided into Airborne Laser Scanning (ALS), Terrestrial Laser Scanning (TLS), and Mobile Laser Scanning (MLS). All three methods have found wide application for collecting spatial data in geodesy, whose products are used in different disciplines. ALS method is usually used for large areas and objects, wherever it is necessary to collect massive data in a short time. This method is mainly used to collect data in cadastre [1, 2], hydrography - bathymetry [3], biology [4, 5], geology [6], weather disasters [7], and various similar areas. Data collected by TLS method have found wide application in engineering geodesy for the needs of: deformation analysis of buildings [8, 9], architecture [10], glaciers [11], forestry [12], mining [13], and other areas. The third method of laser scanning - MLS has been applied for 3D cadastral [14, 15], for road infrastructure monitoring [15, 17] and in various other fields such as forestry [18]. Furthermore, these three methods are applied in combination for some disciplines such as 3D cadastre [19, 20], hydrography [21], indoor laser scanning [22, 23] and many other purposes.

Spatial data is used for the digital representation of the Earth's surface and objects located on it, such as buildings, roads, vegetation, and other human creations. Contemporary topographic maps are made in digital form, i.e. as digital topographic maps. In order to collect necessary spatial data for that purpose, various surveying methods and techniques can be applied, including the conventional terrestrial surveys and photogrammetry, methods of global positioning (RTK - GNSS) and different types of remote sensing methods including MLS.

Papers published in the last several years indicate the increasing number of applications of MLS in the field of urban 3D modeling mainly for creating detailed digital topographic maps and detection and extraction of urban objects [17, 23].

Processing of MLS data, similarly as for the other types of laser scanning data, involves classifying points from the cloud according to the phenomena and objects they relate to. In addition, to create a digital topographic map, it is necessary to create the appropriate content built upon point clouds in the form of vector data: points, lines and surfaces with appropriate geometry, topology and other attributes related to these vector data. Forming the content of a detailed digital topographic map based on point clouds is a complex task, because it demands that information that are implicitly contained in the point cloud are extracted and made explicit. This process involves the use of manual, or preferably automatic procedures supported by the appropriate software tools to make the whole process as efficient as possible, but also to ensure appropriate quality control of the collected data and the process itself. The main goal of this study is to present a methodology for creating detailed digital topographic maps using the data obtained by MLS, using various software tools.

2. OUTLINE OF THE METHODOLOGY

MLS survey is carried out using a scanning system consisting of a vehicle-mounted scanner (or other platform moving on the surface of the earth) that collects data in motion on a predefined path [24, 25]. In general, MLS system configuration usually integrates LiDAR sensors, location and navigation sensors (e.g., Global Navigation Satellite System (GNSS) antenna, an Inertial Measurement Unit (IMU), and a Distance Measurement Indicator (DMI)), advanced digital cameras, and a centralized computing system for data synchronization and management [17, 23]. When the platform is in motion, MLS can efficiently collect three-dimensional measurements of the environment. Today, the standard MLS can collect 1 million points per second, meaning that the system can cover the predefined path and the surrounding surface with a point density of 2000 points per m², where the distance between points ranges from a few mm to a few cm, at the vehicle speed from 10 to 100 km/h [25].

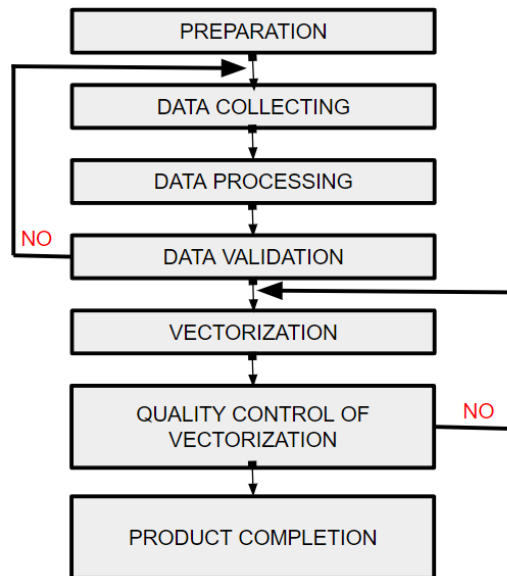

Figure 1. *Flowchart of the applied methodology*

As already mentioned, creating a digital topographic map based on MLS survey data is a very complex task. In general, the applied methodology depends on the MLS system, object and phenomena that are surveyed and the final product specification. The applied methodology is shown on the diagram above on Figure 1. The procedures of the methodology will be explained in the following sections.

Methodology presented in this study is generally used when this type of data is to be used for making digital topographic maps. For some of the procedures, for example vectorization and quality control of vectorization, productivity can be improved by introducing more or less automation, such as machine learning – for automatic feature extraction [1, 4, 18, 19]. Also, methodology could be different if one processes the data obtained by systems that don't have an integrated camera.

Firstly, all the data related to the route of vehicles must be prepared, such as a path plan. Also, marking of ground control points (GCPs) [26] which are to be used later for processing and validation of point clouds has to be finished. The path plan consists of lines representing the streets that need to be surveyed, usually in *.kmz or *.kml format. The locations of the GCPs are selected/chosen according to the project extent. Any method providing sufficient positional accuracy can be used to determine coordinates of GCPs. GCPs must be marked on the ground before mobile laser scanning starts. After data preparation, installed instrument is calibrated before the actual laser scanning takes place. Movement at a certain speed and in certain directions in order to define the domain of all the parameters necessary for surveying.

Before data collection starts, the reference permanent GNSS station must be turned on. The permanent GNSS station works one hour before and after data collection with MLS.

The team for MLS surveying consists of two people, who set up the instrument together on the roof of the car [27]. During surveying, one team member drives a car and the other one works on the PC tablet, where the *.kmz or *.kml file with the path of the car route is loaded, facilitating the survey according to the planned route. Collected data includes the laser scanner data, spherical photography imagery and Inertial Navigation System (INS) and GNSS data.

The first activity within MLS data processing phase is synchronization of the data from the INS unit and RINEX (Receiver INdependent EXchange format files contain raw satellite navigation system data relative to a specified interval of time) files. After synchronization, the obtained data must be processed in relation to the reference GNSS station in order to obtain the positions and orientation angles of the MLS device at every moment during the process of data collection (survey process). After the trajectory is determined, the generation of point clouds and spherical photographs (360° images) can start.

Once the point clouds are created, fine alignment should be done, which ensures high data quality, eliminates anomalies, eliminates dissents in multiple car passages, etc. After alignment, a definite point cloud is available for further processing.

GCP coordinates are determined with classic geodetic surveying method (Global Navigation Satellite System – Real Time Kinematic, GNSS - RTK) during preparation phase. Marked GCPs have to be found in the definitive point cloud and their coordinates have to be calculated. Two sets of

coordinates (two locations) for the same GCP that are determined with different methods, can be used in the next step - the validation of the collected data. The GCP coordinates determined by the GNSS - RTK method are treated as reference ones, so these are used to determine the deviations of the point clouds from the reference positions.

After successful data validation, point clouds can be used for vectorization. Various software applications are designed and developed to facilitate this activity (online or desktop versions). The software enables creation of the digital content representing the terrain surface or objects on the terrain. Certain software products provide support for automatic [25, 26] or semi-automatic segmentation, classification and interpretation of the point cloud data.

Procedures for automatic vectorization are based on machine learning techniques and they provide simpler and easier vectorization. However, manual vectorization is still providing the results with better accuracy and precision. Both of these approaches result in errors which must be detected and eliminated. Various controls can be designed and implemented depending on specific projects and product specifications. For example, two such quality controls have been applied within the methodology that will be presented within this paper: Identification of intersection points and Checking the point elevation using contour lines. These controls have proven to be an excellent solution for quality control of vectorization [25].

Final activities are dedicated to cartographic design (layout) of the created topographic map content. Among other things, this assumes application of prescribed map symbol library for spatial features and arrangement of labels (elevations). Sometimes, creation of topology between spatial features could be required. Once again, software tools enabling automatic, semi-automatic or manual data processing can be used. Cartographic design is governed according to rules that are prescribed by relevant rulebooks. In Serbia, these rules are specified by the digital topographic key (DTK) that is defined and published by the Republic Geodetic Authority (RGA). Proper DTK symbol must be assigned to each spatial entity (feature). There are many solutions for labels (elevations) arrangement on the map, so their overlapping is prevented. Of course, the easiest way is to use automatic procedures for this purpose. Sometimes, this also means that certain labels have to be disabled from the displaying.

3. METHODOLOGY VERIFICATION

The methodology outlined in the previous section has been verified within an experiment. In general, the software used for methodology implementation can be commercial, free, or developed in-house. All types of programs were used within this study for methodology verification. Usually, work with laser scanning data requires integration of various software products due to the complexity of the data. Some of the software tools used for methodology verification will be presented in the paper (Figure 2).

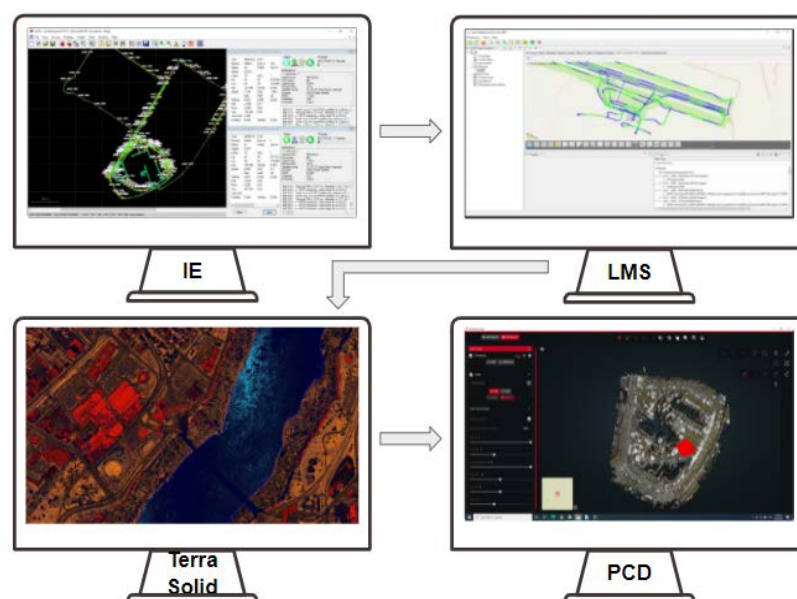

Figure 2. Major Software tools used for methodology implementation

3.1. STUDY AREA

The municipality of New Belgrade is one of seventeen that comprise Belgrade, the capital of the Republic of Serbia. New Belgrade is divided into 83 large rectangular residential blocks that are separated by wide boulevards. The study area, residential block - Block 19a, is located on the left bank of the Sava River, and covers an area of approximately 8 ha, of which 6 ha are built-up areas (4.5 ha - buildings and 1.5 ha - roads, sidewalks, green area, parking, etc.) (Figure 3.).

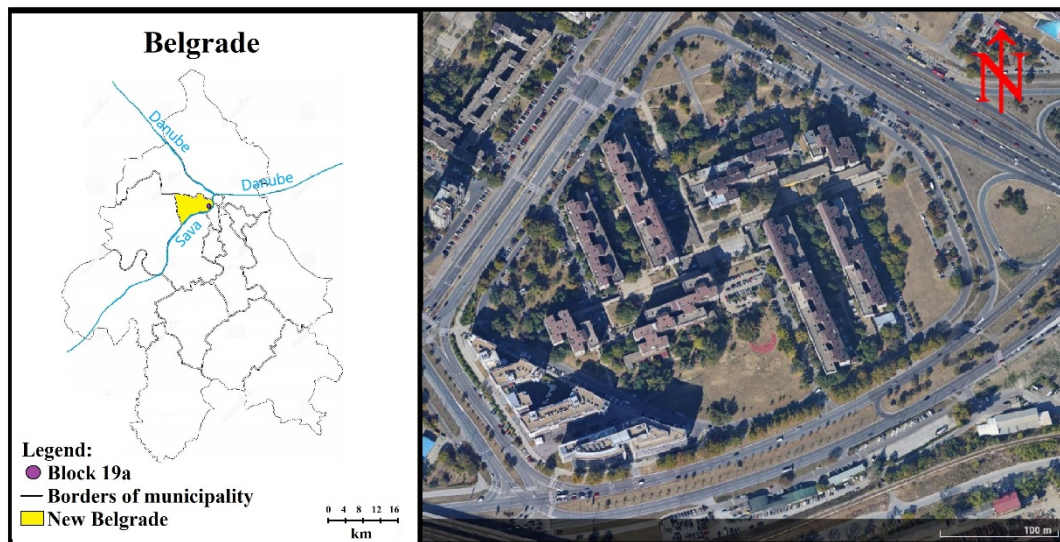

Figure 3. Study area (New Belgrade - Block 19a)

3.2. PREPARATION

Firstly, the optimal route, i.e. path plan for MLS system movement has to be defined. Things that have to be taken into consideration are: area/objects that are to be surveyed, street direction, traffic density during the surveying period and other things that affect the movement of the car. Path plan file is provided in *.kml or *.kmz format.

As already stated, another activity within preparation phase is to specify locations for GCPs. This task is very important because location of these points will influence how easy and fast it will be to find them in point clouds during the MLS data vectorization and validation phase. GCP must be marked on terrain before surveying. Precise locations of 10 GCPs were determined by using GNSS - RTK technique (3 x 30 seconds observations). Locations of these GCPs are given on Figure 4.



Figure 4. Locations of GCPs

3.3. DATA COLLECTING

Laser scanning data is collected within reference coordinate system that is related to the GNSS permanent station. The ASCII format (XYZ RGBI) is a basic and the simplest digital format for saving data collected from LiDAR. Depending on the method and instrument used for surveying, in most cases, specialized data collection software is provided by the MLS system provider. In this case, Teledyne Optech Maverick [28] system has been used. The system has its own software application for data collection that can connect on Wi-Fi and it can be used on devices such as PC, tablet or mobile phone.

After the system is installed on the car, the system has to be calibrated driving 35 km/h for 10 minutes. Collection of MLS data is carried out by driving the vehicle and surveying the area of interest according to the prepared path plan.

Total area covered by MLS survey is 12.8 ha (wider area is covered). Total area of interest, that is the area of the city block including streets on the block border, is 8.5 ha. Total number of MLS point cloud points is 280882394. Average point cloud density is 2246 points/m².

3.4. DATA PROCESSING

In order to combine the LiDAR data and the INS data together, the NovAtel Inertial Explorer (IE) [29] software is used. The result is provided in Exchange Format file which contains information about the position and orientation of the MLS device in every moment of the survey.

As explained in the methodology, the next steps are to generate raw point clouds and spherical photography imagery, their synchronization and adding texture to points of the point cloud. Lidar Mapping Suite (LMS [29]) is used for this task. The software performs basic synchronization of trajectory data (the result of processing in the NovAtel Inertial Explorer software tool).

After collecting and processing the data, the following step could be fine-leveling processing. This step isn't necessary, because two previous steps are sufficient for many projects. However, this processing was also done within methodology verification. TerraSolid, the most popular commercial software, is used for this kind of processing [29]. TerraSolid software is comprised of many software products. In this case, TerraScan and TerraMatch products were used for fine processing of point cloud data.

During the process of fine alignment of point clouds obtained from different positions, accuracy of 3 cm has been achieved.

3.5. DATA VALIDATION

For such a large project area, it is necessary to mark 10 GPC points as shown in Figure 4. Data validation phase includes calculation of the differences between coordinates of GCP that have been digitized in the point cloud and the coordinates of the same GPC that have been measured with GNSS. Horizontal and vertical differences for GCP points are given in Table 1. According to these values, it can be stated that achieved accuracy of point cloud georeferencing is in line with the expectations.

Table 1. Horizontal and vertical differences of coordinates at GCPs

Coordinates from GNSS-RTK				Differences at GCP	
Point number	E [m]	N [m]	h [m]	Horizontal differences [m]	Vertical differences [m]
35	454665.83	4961501.20	118.22	0.02	0.03
36	454851.45	4961391.32	117.89	0.01	0.00
37	454953.94	4961418.86	118.17	0.02	0.00
38	455069.11	4961568.87	119.36	0.02	0.00
39	454963.85	4961701.62	117.85	0.04	0.00
41	454899.34	4961681.52	118.21	0.04	0.02
42	454841.41	4961719.37	118.27	0.02	0.00
43	454784.97	4961690.20	120.42	0.02	0.03
44	454722.59	4961595.71	118.66	0.02	0.05
45	454905.56	4961527.34	118.45	0.03	0.03

All coordinate differences are positive values.

3.6. VECTORIZATION

Vectorization can be done in many online or desktop applications, commercial or in-house developed an application. The vectorization aims at presenting real-world features by using certain map features (using adequate feature geometry: point, line and polygon). For each of these features a set of attributes is assigned according to specified data model. According to the requirements of the investor and/or certain regulations or accepted norms from the professional practice, requirements related to spatial features and the relationships between them are followed (for example, proper spacing between adjacent points on linear feature in order to preserve geometry of the curve during it's discretization).

Point Cloud Desktop (PCD, Figure 5a) is a software application for vectorization from point cloud data developed by Geoput d.o.o. This application has been used for the methodology verification. The data structure used by this application consists of 4 parts (types of datasets): point clouds, spherical photography images, templates with defined geometry and a project-related data. The point cloud data are given in universal point cloud format - LAS that is supported by most, if not all, software applications developed for point cloud management. Templates can be added before or after images, during vectorization, and it is also possible to create new ones.

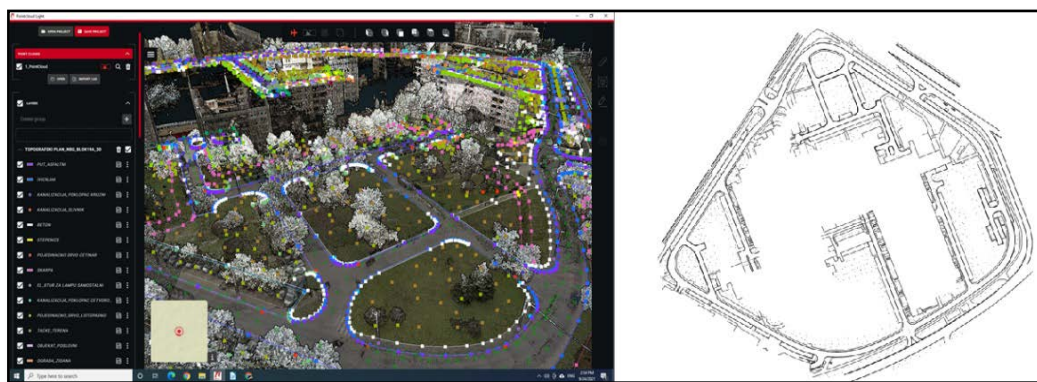

Figure 5. a) Vectorization area in Point Cloud Desktop application and b) Vectorized data in AutoCAD

Total number of map points after data vectorization is 6219. 425 of these points are used for terrain surface modelling and 5794 points are used for other map features.

3.7. QUALITY CONTROL OF VECTORIZATION

Vectorization process, especially in case of manual or semi-automatic vectorization, is prone to errors. Therefore, control of the vectorized data has to be provided in terms of geometry and topology of the map features, but also regarding the attributes assigned to these features. For example, every intersection of two lines should have intersection point feature, only terrain points should be used for DTM creation, etc.

Identification of intersection points (Figure 6a) controls if two lines, that are in the same plane, have a point at their intersection. If there isn't one, the software will automatically show an error and the place where it occurred. Only the first step in the control - identification of intersection points is shown (Figure 6a), where it is shown that one line is snapped to the other without the existence of the point of intersection. This error can be fixed by adding the point at the intersection.

Checking the terrain points using contour lines (Figure 6b) controls whether only terrain points are used for DTM creation. If so, contour lines should look naturally. Framed part in the Figure 6b shows a part where contour lines are more concentrated than they should be, and that (peak) point has to be checked visually and corrected, if needed.

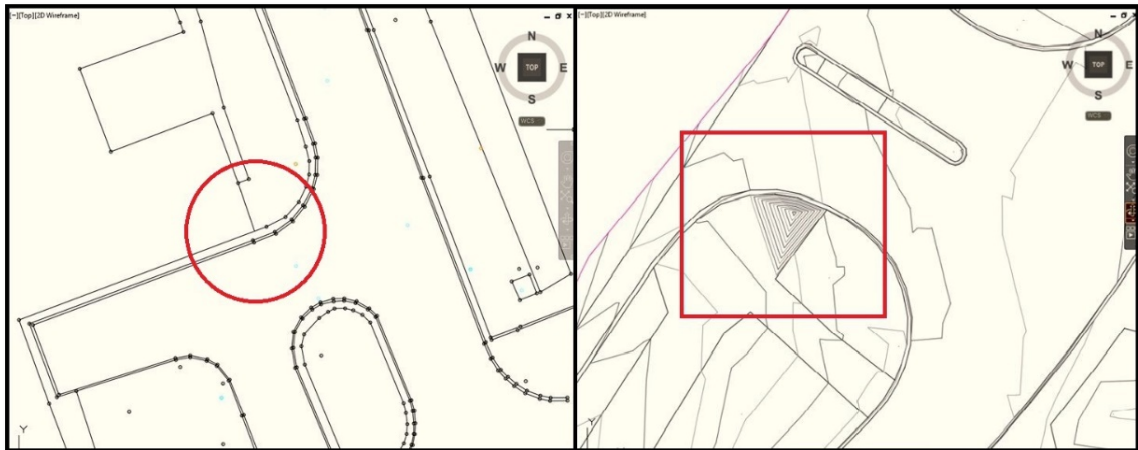

Figure 6. a) First control - Identification of intersection points and b) second control - Checking the terrain points using contour lines

3.8. PRODUCT COMPLETION

The next processing phase assume cartographic processing of the verified vectorized data. First of all, DTK symbols have to be assigned to map features. The data are exported from PCD using in GeoJSON format and loaded into software application where cartographic data processing can be done.

There isn't a set of rules that needs to be followed, but it is shown that it is best to start from more simple ones, such as point features. The next ones are lines with their orientations, then hatches for areal features and at the end, labels (text) are added (Figure 5b). Topographic map layout after cartographic processing of the vectorized data is given on Figure 7.



Figure 7. Cartographic processing of vectorized data

Also, elevations for some points (usually terrain points) have to be displayed as map labels. This can be done by using GIS or CAD software. As for other labels, elevation labels have to be placed on the map so that they are not overlapping with each other and with other map features. This can be done manually, or more or less automatically by using some software tools.

4. COMPARATIVE ANALYSIS

Different methods can be used for collecting data for creating a detailed topographic map. The choice of methods depends on many factors (equipment and other resources, required accuracy and level of detail, project area, etc.). Comparative analysis was performed between conventional measurement technique (total station survey) and MLS.

Table 2. Comparative analysis between a conventional geodetic survey and MLS

	Total station survey	MLS
Data collection and processing	20 days	9 days
Team size	4 members	4 members
Acquisition of missing data	All team members	One team member
Initial costs for equipment	Low	High

For the presented experiment, the first two phases, Preparation and Survey, lasted 1 day with 2 team members engaged. This was followed by Processing and Validation of the data which lasted 1 day and was done by 1 team member (software processing time lasted for 12 h). Vectorization was done by 4 team members in 6 days. The number of people engaged in the vectorization phase can be higher or lower, but 4 members were chosen so that it could be more easily compared to the total station 4-member team size. The last two phases, Quality Control and Topographic plan, lasted 1 day with 1 team member engaged. Cumulatively, the mentioned phases lasted 9 days, of which the field works lasted 1 day, whereas the conventional total station survey would have taken 10 field days followed by additional 10 days for data processing.

From this comparative analysis it is clear that surveying with MLS is twice as fast. Also, this method does not constantly depend on atmospheric conditions. MLS provides possibilities for easier and faster acquisition of missing details. The disadvantage of the MLS is that initial investment in acquiring and making operational the system is much higher and the surveying can be done only near the road (it is not possible to survey areas inside building blocks), because the surveying is from the car, and it is usually difficult or impossible to enter the off-road area.

5. CONCLUSION

Modern technology speeds up and facilitates the processes of making detailed topographic maps. MLS enables collecting a vast amount of data in a very short time. No time is wasted on placing the instrument from one point to another. Instead of that, the instrument is placed on the vehicle from the beginning to the end of the surveying. This saves time and resources and provides data that can be used for different projects. However, processing of massive quantity of LiDAR data requires adequate procedures and software tools. Extraction of spatial features that constitute the content of topographic map from point cloud data is still time-consuming process. This process can be improved significantly by developing and implementing automatic procedures. The only disadvantage of the MLS technique is that initial investment is much higher and the surveying in urban places is limited to facilities that are near roads (not behind fences or deep inside building blocks). That is why, MLS, is especially useful for the survey of road/street and railway infrastructures. It should be noted that the objective of this study was the methodology for making detailed topographic maps. The reason for this is that many users of spatial data in Serbia still prefer to use spatial data in map format. However, MLS data open-up possibilities for making more sophisticated products (3D models or spatial databases). Therefore, afford should be made by all stakeholders to unlock these possibilities.

ACKNOWLEDGEMENTS

The authors are thankful to the d.o.o. Geoput, d.o.o. for providing the datasets used for this study.

LITERATURE

- [1] X. Luo, R. M. Bennett, M. Koeva, & C. Lemmen, "Investigating semi-automated cadastral boundaries extraction from airborne laser scanned data", *Land*, 2017, 6.3: 60.
- [2] G. Vosselman, P. Kessels, & B. Gorte, "The utilisation of airborne laser scanning for mapping", *International Journal of Applied Earth Observation and Geoinformation*, 2005, 6.3-4: 177-186.
- [3] G. Mandlbürger, "A review of airborne laser bathymetry for mapping of inland and coastal waters", 2020.
- [4] J. Hyyppä, H. Hyyppä, D. Leckie, F. Gougeon, X. Yu, & M. Maltamo, "Review of methods of small-footprint airborne laser scanning for extracting forest inventory data in boreal forests", *International Journal of Remote Sensing*, 2008, 29.5: 1339-1366.

- [5] D. Riano, E. Meier, B. Allgöwer, E. Chuvieco, & S. L. Ustin, "Modeling airborne laser scanning data for the spatial generation of critical forest parameters in fire behavior modeling", *Remote sensing of Environment*, 2003, 86.2: 177-186.
- [6] N. Brodić, Ž. Cvijetinović, M. Milenković, P. Dorninger, M. Mitrović, M. & M. Milenković, "Airborne Laser Scanning (ALS) point cloud ground filtering for area of an active landslide (Doren, Western Austria)", *EGU General Assembly 2014*, held 27 April-2 May, 2014 in Vienna, Austria, 2014, 16: 15341.
- [7] M. I. Hariyono, A. A. Kurniawan & M. P. Tambunan, "The use of airborne Lidar data to analyze flood disaster area: case study of Sekarbela Subdistrict, Mataram", in *IOP Conference Series: Earth and Environmental Science*, IOP Publishing, 2022. p. 012086.
- [8] T. Zieher, M. Bremer, M. Rutzinger, J. Pfeiffer, P. Fritzmann, & V. Wichmann, "Assessment of landslide-induced displacement and deformation of above-ground objects using UAV-borne and airborne laser scanning data", *ISPRS Annals of Photogrammetry, Remote Sensing & Spatial Information Sciences*, 2019, 4.
- [9] J. Popović, J. Pandžić, M. Pejić, P. Vranić, B. Milovanović, & A. Martinenko, "Quantifying tall structure tilting trend through TLS-based 3D parametric modelling", *Measurement*, 2022, p.110533.
- [10] T. P. Kersten, & M. Lindstaedt, "Virtual architectural 3D model of the imperial cathedral (Kaiserdom) of Königslutter, Germany through terrestrial laser scanning", in *Euro-Mediterranean Conference*. Springer, Berlin, Heidelberg, 2012. p. 201-210.
- [11] A. B. Voordendag, B. Goger, C. Klug, R. Prinz, M. Rutzinger, & G. Kaser, "Automated and permanent long-range terrestrial laser scanning in a high mountain environment: Setup and first results", *ISPRS Annals of the Photogrammetry, Remote Sensing and Spatial Information Sciences*, 2021, 2: 153-160.
- [12] H. G. Maas, A. Bienert, S. Scheller, & E. Keane, "Automatic forest inventory parameter determination from terrestrial laser scanner data", *International journal of remote sensing*, 2008, 29.5: 1579-1593.
- [13] N. V. Nghia, N. Q. Long, N. T. Cuc, & X. N. Bui, "Applied Terrestrial Laser Scanning for coal mine high definition mapping", *World of Mining-Surface and Underground*, 2019, 71.4: 237-242.
- [14] M. Hao, Z. Liu, & Y. Sun, Yushan, "Assessment of mobile laser scanning data for building reconstruction in 3D cadastre", in *2011 International Symposium on Image and Data Fusion*, IEEE, 2011. p. 1-4.
- [15] J. Bydłosz, A. Warchoń, M. Balawejder, & A. Bieda, "Practical verification of Polish 3D cadastral model", 2021.
- [16] X. Mi., B. Yang, C. Chen, M. Yang, & Z. Dong, "Automatic Road Structure Detection and Vectorization Using Mls Point Clouds", *The International Archives of Photogrammetry, Remote Sensing and Spatial Information Sciences*, 2019, 42: 1069-1075.
- [17] L. Ma, Y. Li, J. Li, C. Wang, R. Wang, M.A. Chapman, "Mobile Laser Scanned Point-Clouds for Road Object Detection and Extraction: A Review", *Remote Sensing*, 2018, 10, p. 1531.
- [18] A. Bienert, L. Georgi, M. Kunz, G. von Oheimb, & H. G. Maas, "Automatic extraction and measurement of individual trees from mobile laser scanning point clouds of forests", *Annals of botany*, 2021, 128.6: 787-804.
- [19] M. Rutzinger, S. O. Elberink, S. Pu, & G. Vosselman, "Automatic extraction of vertical walls from mobile and airborne laser scanning data. *International Archives of Photogrammetry, Remote Sensing and Spatial Information Sciences*, 2009, 38. W8: 7-11.
- [20] K. V. Tikhonova, Y. S. Solovyova, V. S. Geydor, & D. A. Tikhonov, "Technology of three-dimensional laser scanning of real estate objects (3D modeling) in cadastral activities. In: *IOP Conference Series: Earth and Environmental Science*. IOP Publishing, 2021. p. 042071.
- [21] C. Tomsett, & J. Leyland, "Remote sensing of river corridors: A review of current trends and future directions. *River Research and Applications*, 2019, 35.7: 779-803.
- [22] F. Yang, G. Zhou, F. Su, X. Zuo, L. Tang, Y. Liang, ... & L. Li, "Automatic indoor reconstruction from point clouds in multi-room environments with curved walls. *Sensors*, 2019, 19.17: 3798.
- [23] C. Wang, S. Hou, C. Wen, Z., Gong, Q. Li, X. Sun, & J. Li, "Semantic line framework-based indoor building modeling using backpacked laser scanning point cloud", *ISPRS journal of photogrammetry and remote sensing*, 2018, 143: 150-166.

- [24] A. Kukko, H. Kaartinen, J. Hyypä, & Y. Chen, "Multiplatform mobile laser scanning: Usability and performance", *Sensors*, 2012, 12.9: 11712-11733.
- [25] C. Wang, C. Wen, Y. Dai, S. Yu, & M. Liu, "Urban 3D modeling with mobile laser scanning: a review", *Virtual Reality & Intelligent Hardware*, 2020, 2.3: 175-212.
- [26] P. Martínez-Carricondo, F. Agüera-Vega, F. Carvajal-Ramírez, F. J. Mesas-Carrascosa, A. García-Ferrer, & F. J. Pérez-Porras, "Assessment of UAV-photogrammetric mapping accuracy based on variation of ground control points", *International journal of applied earth observation and geoinformation*, 2018, 72: 1-10.
- [27] W. Tan, N. Qin, L. Ma, Y. Li, J. Du, G. Cai, & J. Li, "Toronto-3D: A large-scale mobile lidar dataset for semantic segmentation of urban roadways", in *Proceedings of the IEEE/CVF conference on computer vision and pattern recognition workshops*, 2020. p. 202-203.
- [28] N. Suttisangiam, & S. Bamrungpruk, "Software-based Timing Synchronization for Point Cloud Reconstruction", in *2018 International Conference on Intelligent Informatics and Biomedical Sciences (ICIIBMS)*, IEEE, 2018. p. 37-41.
- [29] C. I Miller, J. J. Thomas, A. M. Kim, J. P. Metcalf, & R. C. Olsen, R. C., "Application of image classification techniques to multispectral lidar point cloud data", in *Laser Radar Technology and Applications XXI*, SPIE, 2016. p. 286-297.



Slavko Vasiljević, University of Banja Luka, slavko.vasiljevic@aggf.unibl.org

Branko Milovanović, University of Belgrade, milovano@grf.bg.ac.rs

DESIGNING OF CONTINUOUS DAM MONITORING USING GLOBAL NAVIGATION SATELLITE SYSTEMS

Abstract

The paper presents the procedure for designing a geodetic system for continuous dam monitoring and equipment necessary for the application of the *Global Navigation Satellite System (GNSS)*. It also points out the conditions that must be respected when choosing the position of the network points and indicates the advantages and disadvantages of this system in relation to systems based on terrestrial methods. Basically, both systems provide the data necessary to monitor dam stability. Theoretical considerations have been applied to monitoring system of *Soubella* earth-filled dam, in Algeria. The dam created an artificial lake with a capacity of 160,000,000 m³, providing water for irrigation in the settlement below the dam. Due to the settlement vicinity, it is planned to carry out continuous dam monitoring.

Keywords: continuous monitoring, global navigation satellite system, dam

ПРОЈЕКТОВАЊЕ КОНТИНУИРАНОГ МОНИТОРИНГА БРАНА ПОМОЋУ ГЛОБАЛНИХ НАВИГАЦИОНИХ САТЕЛИТСКИХ СИСТЕМА

Сажетак

У раду је приказан поступак пројектовања геодетског система за континуирани мониторинг брана и опрема неопходна за примјену Глобалног Навигационог Сателитског Система (ГНСС). Наглашени су услови који се морају поштовати при избору положаја тачака мреже. Наведене су предности и недостаци овог система у односу на системе засноване на терестричким методама. У суштини, оба система дају податке неопходне за осматрање стабилности бране. Теоријска разматрања су примјењена на систему за осматрање земљане бране *Soubella*, у Алжиру. Изградњом бране формирано је вјештачко језеро капацитета 16000000 m³ из којег се обезбјеђује вода за заливање у насељу непосредно испод бране. Због близине насеља предвиђено је континуирано праћење бране.

Кључне ријечи: континуирани мониторинг, глобални навигациони сателитски систем, брана

1. INTRODUCTION

Structural deformations occur under the influence of the following causes: general (physical and mechanical properties of the soil, tendency of soil to plastic or elastic deformations, heterogeneous composition of the soil, hydro technical conditions) and special (deficiencies and inaccuracies in geological and hydrological soil examination, poor water drainage, washing soil particles, scouring from surface waters, wetting of loess soil, dissolution of frozen soil, artificial lowering of groundwater, omissions during construction, upgrades, etc.) [1].

Construction monitoring is carried out: to prevent human and material disasters, improve the quality of future construction, as well as for scientific purposes. Monitoring could be defined as research that includes several professions: civil engineering, geodesy and mining. The geodetic profession discretizes the object in visible points of the structure and determines the displacements in the absolute (system of the object) and relative system. Geodetic monitoring may be carried out in epochs or continuously. Other professions determine the displacements in relative terms using sensors (inclinometers, extensometers, inverted pendulum, etc.) that are built into the structure during construction [2]. Modern devices from other professions intended for continuous monitoring have the ability to collect data with high frequency (up to 300 Hz), as opposed to the geodetic devices in which the frequencies are significantly lower (5 Hz do 50 Hz) [3].

Development of robotic total stations and introduction of GNSS technology initiated the era of continuous geodetic monitoring. Ever since the introduction of GNSS technology, researchers showed interest in the possibility of its use for the purpose of monitoring facilities. Researchers at the University of Nottingham tested measuring of high-frequency deformations (short-period deformations) using GPS (*Global Positioning System*) technology, and the measurements were compared with accelerometer measurements [4], [5]. It is known that GPS is used to measure movements of maximum frequency up to 10 Hz, that is long-period changes. The development of a new GPS receiver, manufactured by the *Javad Navigation System*, and the application of program developed at the University of Nottingham enabled measuring movement frequencies of 50 Hz, with centimeter accuracy. In one study, the authors [6] compared the estimates of the displacement vector obtained using GNSS technology and an inclinometer. They pointed out that the geodetic measurement technology obtained a spatiotemporal series of displacements in the absolute system, and geotechnical in the relative 2D coordinate system. Considering the fact that the research provided almost identical estimates, they concluded that GNSS technology can be used successfully. Researchers [7] concluded that GNSS technology and longer measurement sessions can achieve a 1 mm precision in the 2D coordinate system and 2 mm precision in the 1D coordinate system.

Apart from the development of measurement sensors and measuring technology in general, great progress in the field of monitoring infrastructure facilities has occurred after the development of the Internet, mobile technology, wireless and time series data processing software [8]. These technical improvements enabled the possibility of networking of measurement sensors and the development of real-time permanent monitoring systems. Modern research is focused on the integration of geodetic and sensors of other professions (primarily geotechnical) and the establishment of active systems for Structural Health Monitoring (SHM). Many research papers have presented the possibilities of GNSS technology in specific experimental settings [9]. However, the systematization of these findings and defining procedures for permanent monitoring designing require particular attention.

This paper presents the process of designing a geodetic system for continuous dam monitoring, with particular reference to the equipment necessary for the application of GNSS technology and its networking into a single system and the specifics that must be observed in selecting the position of control geodetic network points. In order to review all system elements, we carried out research on the existing solutions for continuous monitoring and presented their development. The results of practical research are presented through the project solution of permanent monitoring of the earth-filled *Soubella* dam, particularly emphasizing the following: influence of satellite geometry quality on positioning accuracy, defining the coordinate system of the basic network obtained by GNSS measurements and system components with the most important characteristics. Additionally, it presents the criteria for the geodetic network quality and the displacement measures (movement) that can be detected, obtained by calculating the accuracy for the defined geometry, the observation plan and the adopted measurement precision.

2. DEVELOPMENT OF SYSTEMS FOR PERMANENT GEODETIC MONITORING USING GNSS TECHNOLOGY

The geodetic network for continuous monitoring consists of, as all geodetic networks in engineering, basic network points, which are placed outside the deformation zone, and points on the facility. On the basic network points are installed stationary GNSS receivers or total stations, whereas stationary GNSS receivers, rover stations or prisms may be installed at the points on the facility.

Considering the fact that the permanent monitoring systems are intended for monitoring deformation processes at critical locations, the system management and data processing are carried out in special centers. There are local and management centers. The local center is connected to computers and measurement sensors are attached to it. The connection between local centers and computers is made using cables or wireless (usually radio modems). Vectors are processed in local centers, and they are further forwarded to the control center and corrections are sent to sensors. The number of local centers depends on the size of the monitored location and the configuration of the terrain, that is on the possibility of establishing a direct connection with the sensors. The control center processes measurements from all local centers. Data processing is automatic, and it is conducted using a specially developed program. The system in the control center is often supported by light signals. Usually, if the displacement is within the allowable range, the green lamp is on, in case of alarm (displacement is close to the allowed range), the orange lamp is on, and in case the displacement is outside the allowed range, red lamp goes on, followed by an alert message. However, the final decision on the alert is made by the responsible person due to possible errors in the system. Later in this chapter are presented some of the most frequently used systems for permanent geodetic monitoring.

The best-known monitoring system is *GOCA* (*GOCA - GNSS/LPS/LS-based Online Control and Alarm System*) [10]. This system is intended for determining three-dimensional displacement, and it was developed at the Karlsruhe University of Applied Sciences. In this system, the measured data are sent from the base station by radio communication to rover stations, where vectors are processed. The data on the processed vectors are sent to the *GOCA* center by radio modem for further processing. For each point of the facility, displacement, velocity and acceleration are determined by applying sequential adjustment, i.e. Kalman filter. The *GOCA* system organizational scheme is presented in Figure 1.

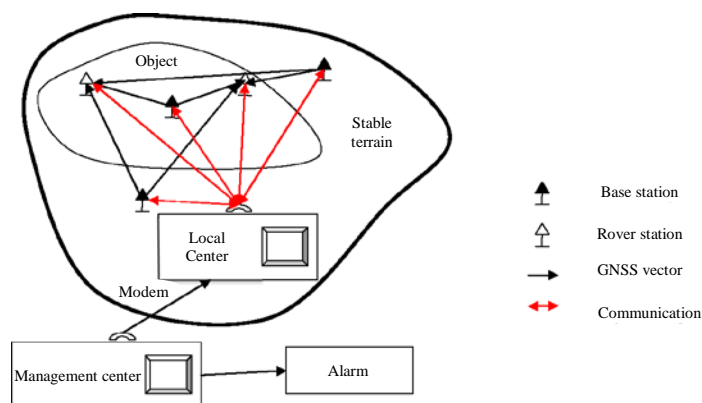

Figure 1. Operation principles and *GOCA* system components [11]

3-D TRACKER is an automated 3D monitoring program developed by the company *Condor Earth Technologies INC*. According to the manufacturer's specification, this program can simultaneously calculate 3D coordinates with millimeter accuracy for dozens of points in which GNSS receivers are located [12]. It is designed for permanent observation, and it can process data from single-frequency and dual-frequency receivers. It applies a different principle for vector processing from the standard RTK (Real Time Kinematic) method. In the RTK method, vectors are processed in a mobile station (rover), and in this program, vector processing is performed in a central station. It forms triple and double differences and epoch-by-epoch coordinate estimates are obtained using the Kalman filter.

LEICA GeoMoS is a multi-purpose automatic monitoring program. It is used for deformation monitoring of structures (dams, tunnels, bridges, tall buildings), landslides, in mines and on volcanic and geotechnically unstable terrain [13]. The program consists of the following modules:

- for monitoring, carrying out control over integrity of the sensor, collecting the measurement results for each measurement moment and analyzing the time series of measurements. Sensors that can be connected for automatic data collection are:
 - geodetic (Leica instruments only): total stations, GNSS receivers, level instruments;
 - meteorological: thermometers and barometers and
 - geotechnical: extensometers, piezometers and inclinometers.
- for analysis, analyzes the accuracy of measurements, enables a graphical display and processes the data and
- additional module, for adjustment, which has functions for epoch-by-epoch network adjustment, deformation analysis and simulation.

The communication of the device is performed using *Leica M-Com* [14] interfaces or standard communication interfaces via the Internet and mobile phone.

Some of the shortcomings of the existing geodetic systems for permanent monitoring that have been identified through research papers are:

- sensors are not located on the facility, but in its vicinity,
- the way of selecting the points that discretize the facility,
- sensor errors and increase in autocorrelation with increasing measurement frequency,
- limited manner of processing and presentation of measurement results due to online mode, etc.

3. SPECIFICITIES OF GNSS MEASUREMENT PLANNING

When planning a GNSS measurement campaign for the development of a GNSS network project, it is necessary to analyze several parameters such as:

- satellite constellations (sky plot of satellites) above the measurement area,
- number and type of receiver (single frequency, dual frequency, triple frequency) that will be used and
- economic aspects.

GNSS measurement requires different planning, implementation and data processing techniques compared to measurements with classical technologies. These requirements come from the difference between GNSS measurement and terrestrial measurement. As opposed to terrestrial measurements, GNSS measurements do not depend on weather conditions and do not require for the receivers to be within sight. The GNSS receiver requires visibility towards satellites.

The shape of the GNSS network does not play an important role as in networks in which terrestrial measurements are performed. The main reason is the mathematical model used in GNSS measurements. This brings us to the conclusion that there is a lot of freedom in designing GNSS networks.

GNSS networks can be shaped as closed (irregular) polygons: triangles, quadrilaterals or polygons. Network of quadrilaterals is recommended, since more closed polygons enable better measurement control. Additionally, it allows better reliability of the obtained results and requires fewer measurements than in the case of triangulation.

The GNSS network shape primarily depends on:

- required accuracy,
- the number of receivers that will be used and
- cost-effectiveness.

According to their form, GNSS networks are divided to [15]:

- radial (star-shaped) networks and
- networks of closed geometric figures.

There are two rules in designing a GNSS network, and one of them must be followed: at least two vectors should start from each point of the network or each point needs to be occupied at least two times.

One of these two rules must be followed in order to prevent blind points in the network. GNSS measurement planning for GNSS network design is most often done in GNSS measurement processing programs that also contain a planning module. Using the planning module saves time and resources in defining the project solution.

GNSS measurement planning for GNSS network design consists of the following stages [16]:

- selection of point positions,

- selection of the observation period,
- determining the duration of the measurement (session duration),
- on-site inspection,
- stabilization of points and
- organization of measurements.

4. INFLUENCE OF SATELLITE GEOMETRY QUALITY ON MEASUREMENT ACCURACY

The quality of determining the position of points using GNSS technology depends on the geometric arrangement of visible satellites. Real-time changes in geometry quality occur due to the mutual movement of the satellites. Geometry quality measures are DOP (Dilution Of Precision) factors. The lower the value of the DOP factor, the better the geometry of the satellite, and the expected quality of the positioning solution. In principle, fair satellite geometry consists of several satellites that are evenly distributed in azimuth and are located slightly above the horizon, with one or more satellites in the direction close to zenith.

Monitoring of engineering structures with GNSS technology, due to the requirements of accuracy, implies the application of the relative positioning method, which is used to obtain 3D coordinate differences between network points. Additionally, phase measurements of pseudoranges are used to determine them. For example, the wavelength of L1 signal is 19 cm, whereas L2 is 24 cm. The accuracy of measuring the phase difference is approximately 1% of the wavelength. In order to reduce or eliminate measurement errors, the following differences are applied: single (eliminating errors in satellite position, satellite clock and ionosphere), double (eliminating errors satellite and receiver clock differences) and triple differences (determining the number of complete wavelengths) [15], [16]. However, the correct estimation of accuracy based on pseudoranges obtained by phase measurements is complex and commercial software does not contain the procedure of preliminary calculation of accuracy based on them, but on the basis of pseudoranges obtained from code measurements.

Since the measurements are error-laden, the code pseudoranges measured simultaneously at time t from station A to n satellite can be mathematically modeled as [17]:

$$P_A^i = r_A^i + c_0 \delta t_A + \varepsilon_A^i = \sqrt{(x_A - x^i)^2 + (y_A - y^i)^2 + (z_A - z^i)^2} + b_A + \varepsilon_A^i \quad (1)$$

where the superscript i has the values $i=1, 2, \dots, n$. The coordinates of the observed satellites (x^i, y^i, z^i) are calculated from the data of the navigation message for the moment of signal transmission and represent known values. For the purposes of preliminary accuracy calculation in the process of designing GNSS networks, almanac data files with predicted satellite position can be used instead of observations and navigation messages.

In the previous model (formula 1) the majority of elements are not present because it is assumed that their values can be determined and subtracted from the measured pseudoranges. The element includes all measurement errors and unmodelled influences related to the code pseudorange, and the element with the receiver clock error is expressed for practical reasons as a value b_A in linear units of measure.

In order to determine the unknown coordinates and clock synchronization errors of the receiver, it is necessary to use a system of at least four equations, that is to measure the pseudoranges to at least four satellites. In that case, the presence of elements ε_A^i is ignored. If the number of equations is higher than four, the presence of errors is taken into account, and solutions are obtained by estimates in accordance with the least square method. Using the least squares method allows determination of estimates of measurement errors, estimates of unit weight standards and covariance matrix of unknown parameters. [17]:

$$C = \sigma_0^2 (\mathbf{A}^T \mathbf{C}_p^{-1} \mathbf{A})^{-1} = \sigma_0^2 \mathbf{Q} \quad (2)$$

It is clear from formula 2 that the quality of positioning primarily depends on two key factors: the quality of performed measurements and the number and arrangement of satellites (matrix \mathbf{Q}). DOP factors are defined and calculated exactly using the matrix \mathbf{Q} elements, as it follows:

- geometric DOP factor:

$$GDOP = \sqrt{\mathbf{Q}_{XX} + \mathbf{Q}_{YY} + \mathbf{Q}_{ZZ} + \mathbf{Q}_{tt}} \quad (3)$$

- position DOP factor:

$$PDOP = \sqrt{Q_{XX} + Q_{YY} + Q_{ZZ}} \quad (4)$$

- time DOP factor:

$$TDOP = \sqrt{Q_{XX} + Q_{YY} + Q_{ZZ}} \quad (5)$$

DOP factors of horizontal position and height, HDOP and VDOP, can be calculated in a similar way, but the cofactor matrix must be previously transformed so that its elements refer to the axes of the local geodetic system instead to the axes of the WGS84 system.

Table 1 presents the values of DOP factors with the interpretation of the possibility of their use in geodetic applications. It can be concluded that the application of GNSS technology in monitoring requires DOP factor values under 3.

The selection of the observation period in defining the project solution presented in practical research was carried out using the software tool *Trimble GNSS Planning Online* [18] and further on in the paper we will present the most important steps and principle of operation of this powerful tool for GNSS measurement planning.

Table 1. Interpretation of DOP factor values

DOP value	Rating	Interpretation
1	Ideal	Highest possible confidence level to be used for applications demanding the highest possible precision at all times.
1-2	Excellent	Accuracy which allows performing highly precise work.
2-5	Good	Accuracy used in navigation and for standard geodetic works.
5-10	Moderate	Accuracy used for calculations.
10-20	Fair	Rough estimate of point position. It is used for designing, determining the approximate positions of points.
>20	Poor	Poor measurement accuracy. All measurements with a DOP factor higher than 20 should be discarded from data processing.

The first and basic thing that needs to be carefully set up is the data on the location where GNSS measurements will be performed and the elevation angle, which can be set up depending on the terrain configuration and project requirements (Figure 2). Additionally, it is necessary to select the day and period of the day for which you want to see the arrangement of satellites for the location of interest. Afterwards it is possible to enter data on obstructions in the field that can interfere with signal reception at measuring stations, setting azimuth and elevation angle (Figure 3).

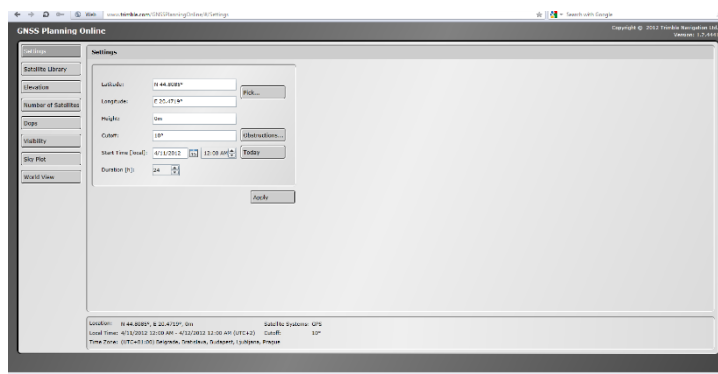

Figure 2. Location data settings

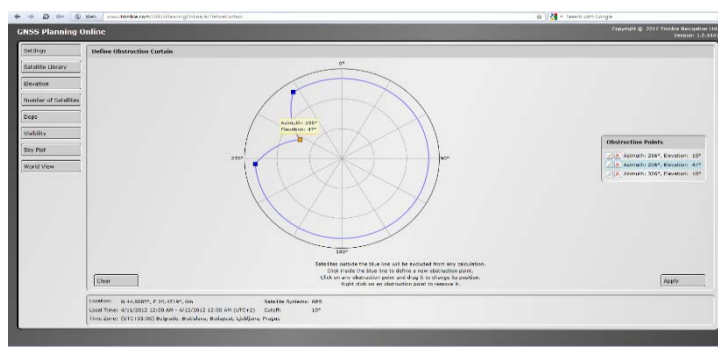
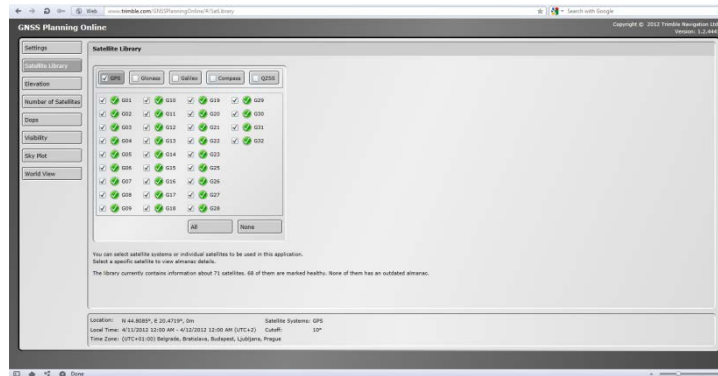
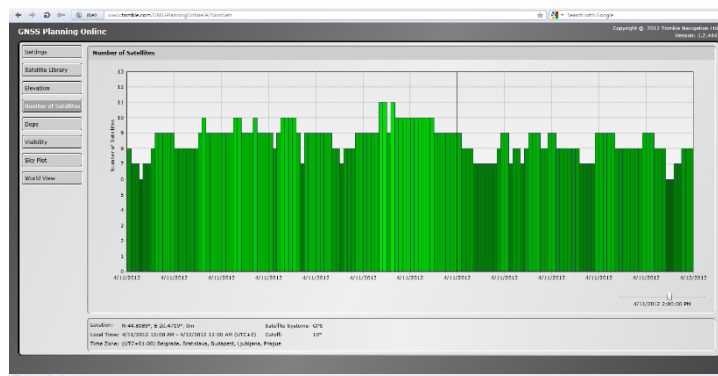
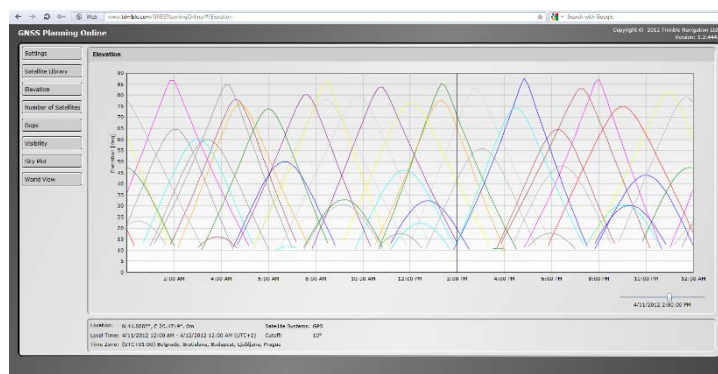

Figure 3. *Obstruction settings*

There are a total of four global and several regional navigation satellite systems nowadays, and some of them have already reached the stage of full operational capability (FOC). In practice, this means that there is a large number of satellites from which measurement signals can be received. Information on satellite correctness and status is publicly available on the official websites. Almost all planning programs provide the option of selecting systems and satellites from which it is planned receive signals, which may be important depending on the type of receiver available (Figure 4).

Figure 4. *Selection of satellite system and satellites from which signals will be received*

Number of satellites (Figure 5), their elevation (Figure 6), DOP factors (Figure 7), visibility above a certain location during the day (Figure 8) and sky plot of satellites (Figure 9) represent standard outputs in the process of GNSS measurement planning available in software and services for GNSS measurement planning.

Figure 5. *Number of visible satellites above a certain location*Figure 6. *Elevations of chosen GPS satellites above a certain location*

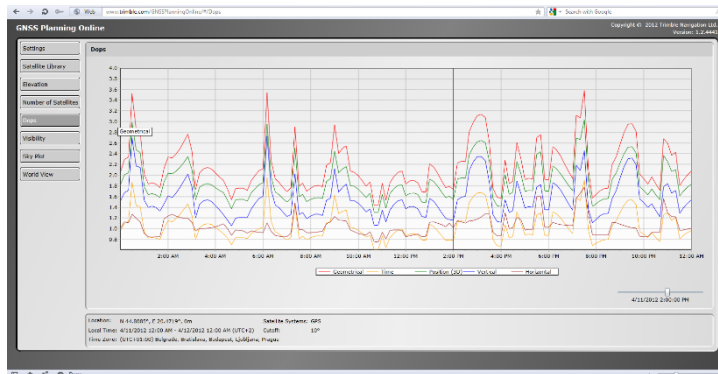

Figure 7. DOPs for satellite geometry above a certain location



Figure 8. Visibility of chosen satellites above a certain location

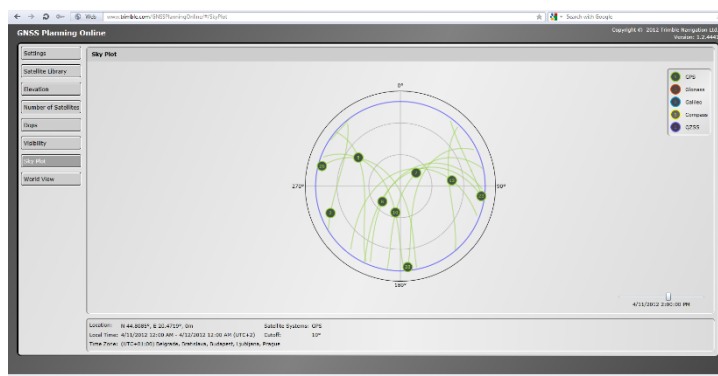

Figure 9. Sky plot of chosen satellites above a certain location

5. PRACTICAL RESEARCH

Practical research was presented through the project solution of permanent GNSS monitoring of the earth-filled *Soubella* dam, on the small river of the same name in *Algeria*. It is an earth-filled dam (Figure 10) with a clay core. The dam is 67 m high. The dam crest width is 10 m, and the spillway is Krieger with one spillway bay. The construction of the dam created an artificial lake with a capacity of 160,000,000 m³, providing water for irrigation in the settlement just below the dam. Due to the settlement vicinity, it is planned to carry out continuous dam monitoring.

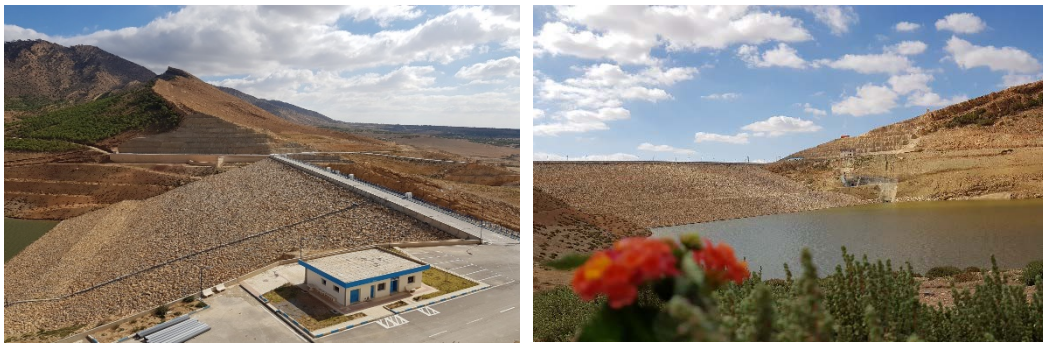

Figure 10. *Soubella dam* [19]

In defining the displacement values that must be detected, we used the standards for monitoring embankment dams shown in Table 2:

Table 2. Accuracy standards of geodetic monitoring of embankment dams [20]

Facility: earth-filled (embankment) dams	Accuracy
Stability of the slope of the dam crest	$\pm 20 - 30$ mm
Horizontality of the dam crest	$\pm 20 - 30$ mm
Dam crest subsidence	± 10 mm

5.1. SELECTION OF NETWORK POINT POSITIONS

In geodetic monitoring of earth-filled dams, the ideal place for setting the points of the geodetic basic network are the rocks, located at depths or the surrounding terrain, in which the influence of water accumulation (basin) is not felt. Basic network established in this way is a precondition for successful geodetic monitoring of the facility, of permanent assessment of absolute displacements. The *Soubella dam* monitoring network consists of four points (Figure 11). Two points represent reference network points and are located on the rock elevations upstream of the dam (GPS1 and GPS4). Two points, GPS2 and GPS3, are located on the dam crest. It was suggested to use concrete pillars in construction of the points. On top of the pillar should be a plate with a central screw, made of stainless metal, in order to install GNSS antennas. On the concrete steps of the pillars are constructed boxes, in which the installed batteries and routers would be protected from the rain, wind and sand.

WGS84 was selected as the coordinate system of the monitoring network, and in that system, in this specific case, are indicated the coordinate differences obtained by applying GNSS technology. Considering the fact that analysis of the dam stability requires comparison of the differences of estimated coordinates between consecutive GNSS measurement epochs, the transformation into the local coordinate system of the object is not anticipated.

5.2. SYSTEM COMPONENTS

The components of the system for *Soubella dam* permanent monitoring system, as defined in the project solution include:

- sensors,
- communication devices and
- control center.

The system designers had to take into account the fact that GNSS sensors for dam monitoring already existed, and they had to be included in the project solution. These include four *Leica GMX910* GNSS receivers [21]. The positioning accuracy using these sensors is:

- for static post-processing: 3 mm + 0,5 ppm (horizontal) and 5 mm + 1 ppm (vertical) and
- for RTK: 8 mm + 0,5 ppm (horizontal) and 15 mm + 0,5 ppm (vertical).

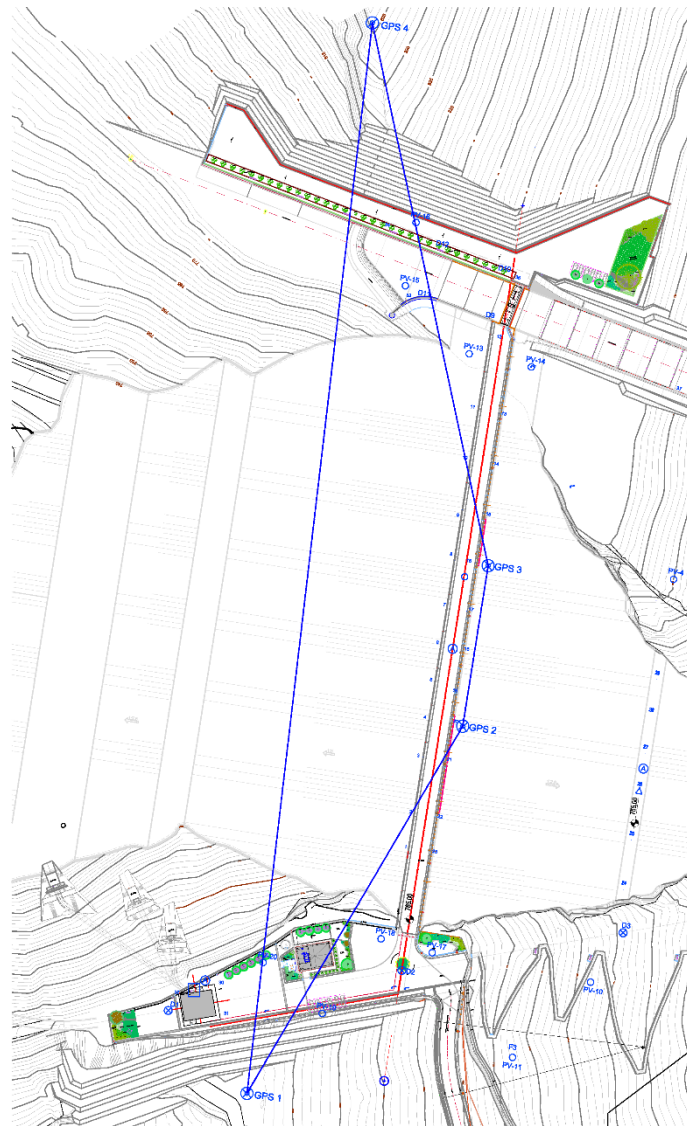

Figure 11. Outline of the geodetic network of Soubella dam permanent monitoring

In addition to GNSS sensors, it is planned to install the following equipment at each point (Figure 12):

- solar panel,
- charger,
- spare battery,
- radio modem and proper antenna,
- RS232 network cable for connecting chargers, receivers and radio modems [22] and
- GEV 197 coaxial cable from *Leica* for link between radio modem and antenna [23].

Charging batteries and receivers is carried out using electric energy which is produced from solar panels on the measuring stations. The modem, chargers, battery and other accompanying equipment at the measuring station are located in a specially designed protective box next to the network pillar. The *Leica GMX910* GNSS receiver is a device with an integrated measuring antenna, hermetically sealed and resistant to external conditions, and therefore requires no additional protection.

Communication between system components is achieved in two ways: by cable connection between individual components at measuring stations and in the control center and using wireless connection between measuring stations and control center. As mentioned above, the cable connection is carried out using network and coaxial cables. Since *Leica GMX910* GNSS sensor is a device that only has an antenna and does not have a data storage unit, the Wireless Local Area Network (WLAN) radio modem continuously sends measurement data from all stations to the control center. The *Leica ComGate10* is a device designed to connect GNSS sensors to LAN (Local Area Network). The

network connection to the sensors is achieved using cables that use USB or serial ports as contact or output/input units. The communication systems scheme is presented in Figure 12.

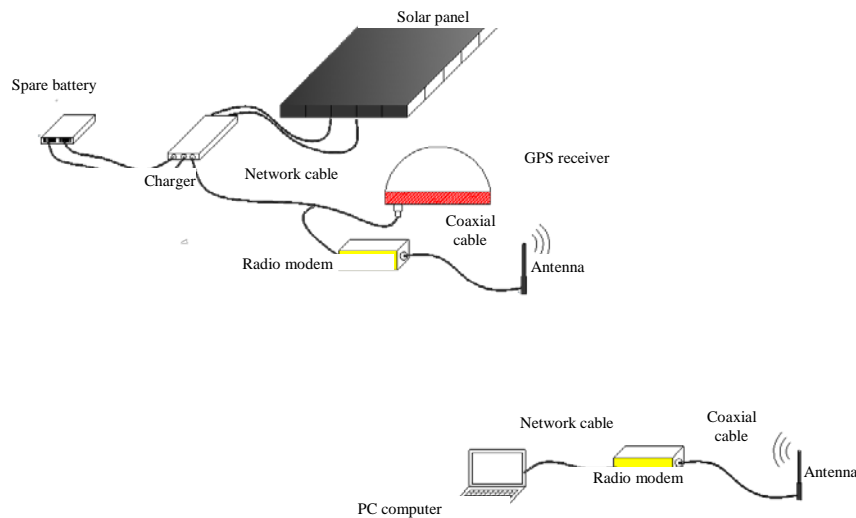

Figure 12. Communication systems scheme: at measuring stations (above) and in the control centre (below)

The system control center is located in the command building, and electric energy is supplied from it. It is designed for the installation of the following equipment:

- a robust PC,
- radio modem,
- RS232 network cable for connecting computers and radio modems and
- *Leica GEV 197* coaxial cable for link between radio modem and antenna.

The minimum computer requirements are 16 GB of RAM, serial and network ports, in order to install *Leica GNSS Spider* [24] and *Leica GeoMoS*, which will process and analyze the collected measurements. *Leica GNSS Spider* is an integrated software package with a primary purpose for centralized control and operation of reference stations and networks. The software is modular and flexible, with new advanced solutions for large high-precision RTK networks and centralized data distribution (*SpiderNET Module*). The *Spider Business Center* module provides efficient management and reporting using an open interface. *Leica GeoMoS* is a multi-purpose software package, which can be used for automatic monitoring of deformations of artificial structures (dams, tunnels, bridges, tall buildings and constructions), as well as for monitoring displacement, subsidence and deformation of natural features. The software is flexible, allowing extension with additional functionalities, and modification depending on the type and number of sensors. All data is stored in an open SQL database, and can be accessed remotely and locally. The project solution considered using both software. In the first step, *Leica GNSS Spider* software will be used for geodetic monitoring of horizontal displacements. In the second step, *Leica GeoMoS* will be installed in order to allow the bodies responsible for monitoring the facility to upgrade the system with non-geodetic sensors and expand it to the SHM monitoring system.

It is planned to perform processing of measurements every hour. In the first step, when using *Leica Spider* software, data post processing will be performed. If the investor decides to use *Leica GeoMoS* software, data processing will also be performed every hour, which will be harmonized with the operation of geotechnical sensors.

5.3. SELECTION OF OBSERVATION PERIOD

The selection of the observation period in defining the project solution was performed using the *Trimble GNSS Planning Online* software tool, as described in Chapter 4. Receivers that will be placed at points on the dam crest (GPS2 and GPS3) cannot receive signals from the entire horizon. Obstructions come from the left side where elevations are located, about 120 m from the points. The receiver at point GPS2 has to receive signals from satellites with elevation angles higher than 18°, and the receiver at point GPS3 has to receive signals from satellites with elevation angles higher than 23°. All these obstructions were taken into account when defining the measurement period and calculating the quality of DOP factors. Also, it is planned that all receivers will receive GLONASS signals.

After defining the input parameters, we determined the values of the characteristic elements of the observation plan. The results showed that the number of visible satellites during the day is from 8 to 16. After calculating the DOP factor for the selected parameters, the least favourable values were:

- GDOP 3.15,
- PDOP 3.01,
- HDOP 1.31 and
- VDOP 2.88.

and based on this it was concluded that measurements at the subject location can be carried out throughout the day.

5.4. CALCULATION OF THE PROJECT SOLUTION ACCURACY

Accuracy of the network quality criteria was calculated for the selected network geometry and vector measurement plan. For the purpose of calculation, the declared values for the measuring equipment to be used were adopted for the accuracy of vector measurement. It is suggested that the point GPS1 is the one that defines the network date. It is planned to measure six vectors, therefore the number of unknown parameters is 9 (three coordinates for three points). For the a priori standard unit of weight, the value 3 was adopted. In calculation was used the value of the level of statistical significance 0.05. The predicted values of specific criteria for the measured values are displayed in Table 3.

Table 3. Quality criteria of measured values obtained by calculation

Coordinate difference	$Q_{v_{ii}}$ [mm ²]	$Q_{l_{ii}}$ [mm ²]	r_{ii}	G_{ii}
$\Delta X_{GPS1-GPS2}$	0.5	0.5	0.5	11.9
$\Delta Y_{GPS1-GPS2}$	0.5	0.5	0.5	11.9
$\Delta Z_{GPS1-GPS2}$	10.0	10.0	0.5	53.9
$\Delta X_{GPS1-GPS3}$	0.5	0.5	0.5	11.9
$\Delta Y_{GPS1-GPS3}$	0.5	0.5	0.5	11.9
$\Delta Z_{GPS1-GPS3}$	10.0	10.0	0.5	53.9
$\Delta X_{GPS1-GPS4}$	0.5	0.5	0.5	11.9
$\Delta Y_{GPS1-GPS4}$	0.5	0.5	0.5	11.9
$\Delta Z_{GPS1-GPS4}$	10.0	10.0	0.5	53.9
$\Delta X_{GPS2-GPS3}$	0.5	0.5	0.5	11.9
$\Delta Y_{GPS2-GPS3}$	0.5	0.5	0.5	11.9
$\Delta Z_{GPS2-GPS3}$	10.0	10.0	0.5	53.9
$\Delta X_{GPS2-GPS4}$	0.5	0.5	0.5	11.9
$\Delta Y_{GPS2-GPS4}$	0.5	0.5	0.5	11.9
$\Delta Z_{GPS2-GPS4}$	10.0	10.0	0.5	53.9
$\Delta X_{GPS3-GPS4}$	0.5	0.5	0.5	11.9
$\Delta Y_{GPS3-GPS4}$	0.5	0.5	0.5	11.9
$\Delta Z_{GPS3-GPS4}$	10.0	10.0	0.5	53.9

Table 4 shows the values of the quality criteria of unknown parameters that can be obtained for the proposed project solution. We calculated the value of standard deviations in the coordinate axes and the displacement values that can be detected from the coordinate estimates, when selecting the power of a test 0.8.

Table 4. Calculation of the accuracy of unknown parameters with the calculation of displacement values that can be detected from coordinate estimates

Point	standard deviations in coordinate axes [mm]			displacement value [mm]		
	σ_x	σ_y	σ_z	dp_x	dp_y	dp_z
GPS2	2.1	2.1	9.5	8.5	8.5	37.6
GPS3	2.1	2.1	9.5	8.5	8.5	37.6
GPS4	2.1	2.1	9.5	8.5	8.5	37.6

Pursuant to the accuracy calculation for the proposed project solution, it can be concluded that after the network adjustment, the displacement values in the coordinate axes in the horizontal plane below 10 mm can be detected, which meets the required criteria for monitoring horizontal displacements of the Soubella dam.

6. CONCLUSION

Monitoring of engineering structures depends on the type of deformations to be detected and the characteristics of the structure. The diversity of structural materials is one of the key factors for the occurrence of structural deformations. In the case of earth-filled and embankment dams, or other similar structures, deformations occur as a consequence of the dam weight and the hydrological influence. The embankment is filled with water causing vertical subsidence. Also, the influence of water level in the accumulation leads to permanent deformations in the horizontal plane. Deformations of such structures can also be a consequence of adaptation to new water waves, aging of the embankment or fatigue of the rock mass in which the structure is built in. Of course, such deformations are not considered significant if they do not pose a threat to the structure safety. In order to determine the stability and safety of the structure, it is necessary to carry out geodetic monitoring of the structure and, if necessary, the surrounding terrain. For a complete insight into the trends of displacements of specific structure points, it is necessary to perform permanent measurements using modern measuring technologies. It is particularly suggested to carry out permanent monitoring, and sometimes it is even requested, on all structures that pose direct threat to settlements, such as the case with the Soubella Dam.

Geometric deformation models were applied in the past, and these did not take into account explicit time, and the forces acting on the structure were not taken into account (congruence model and kinematic models). In the 1990's we started using cause-and-effect models, taking into account time and forces (static and dynamic models). Additionally, the development of new geodetic instruments enabled the possibility of permanent monitoring of critical structures. The application of GNSS technology also enabled special possibilities and advantages in the field of permanent monitoring. Certainly, efforts are being made to optimize its application both in technical and economic terms, as well as in the application of terrestrial measurement technologies. To make this possible, it is necessary to understand the positioning methods and sources of errors affecting the accuracy of their application.

The quality of satellite geometry is characterized by their mutual position in relation to the observation location and has significant effect on measurement accuracy. DOP values are in high correlation with satellite geometry that changes over time due to the relative motion of the satellites. Therefore, DOP values depend on the number of visible satellites. These values are an indicator of the quality of satellite geometry. Good geometry means that the satellites are evenly distributed in all four quadrants.

There were many published scientific and expert papers on the topic of continuous monitoring of individual structures. This paper is a presentation of one view on resolving the problem of designing permanent monitoring using GNSS technology. On the basis of DOP factors, we can evaluate the accuracy of the planned pseudorange measurements and select an appropriate observation period. Application of GNSS model of relative positioning and calculation of the network accuracy allows us to obtain the network quality criteria, and we can see if the suggested geometry and observation plan (functional model) and measurement accuracy (stochastic model) meet the criteria for determining the displacement values of characteristic points and permanent monitoring of the structure in general. It can be concluded from specific practical research that GNSS technology can be used to monitor horizontal displacements even in challenging environments.

However, determining vertical displacements using GNSS technology is still questionable. Certainly, possible improvements in positioning methods, integration with other measuring technologies and sensors of other professions in order to achieve better accuracy in determining vertical displacements are possible directions for further research.

ACKNOWLEDGEMENTS

The project of permanent monitoring of the "Soubella" Dam using GNSS technology is the work of prof. Branko Milovanović, PhD and prof. Dragan Blagojević, PhD, from the Faculty of Civil Engineering at the University of Belgrade, and the holder of operational activities is the company Energoprojekt d.o.o. - Hidroinženjering. The authors of this paper express their gratitude for the data provided.

LITERATURE

- [1] Č. Cvetković, *Primena geodezije u inženjerstvu*. Beograd: Beogradski grafički zavod, 1970.
- [2] M. Marković, "Metoda određivanja deformacija građevinskih struktura primenom fiber optičkih senzora," University of Novi Sad (Serbia), 2018.
- [3] Б. Миловановић, "Линеарно и нелинеарно моделирање геодетски регистрованих деформационих процеса конструкција," Универзитет у Београду, Грађевински факултет, 2012.
- [4] X. Meng, J. Wang, and H. Han, "Optimal GPS/accelerometer integration algorithm for monitoring the vertical structural dynamics," *J. Appl. Geod.*, vol. 8, no. 4, pp. 265–272, 2014.
- [5] G. W. Roberts, E. Cosser, X. Meng, and A. Dodson, "High frequency deflection monitoring of bridges by GPS," *J. Glob. Position. Syst.*, vol. 3, no. 1–2, pp. 226–231, 2004.
- [6] R. Barzaghi, N. E. Cazzaniga, C. I. De Gaetani, L. Pinto, and V. Tornatore, "Estimating and Comparing Dam Deformation Using Classical and GNSS Techniques," *Sensors (Basel)*, vol. 18, no. 3, p. 756, Mar. 2018, [Online]. Available: <https://pubmed.ncbi.nlm.nih.gov/29498650>.
- [7] R. Xiao, H. Shi, X. He, Z. Li, D. Jia, and Z. Yang, "Deformation Monitoring of Reservoir Dams Using GNSS: An Application to South-to-North Water Diversion Project, China," *IEEE Access*, vol. 7, pp. 54981–54992, 2019.
- [8] M. Scaioni, M. Marsella, M. Crosetto, V. Tornatore, and J. Wang, "Geodetic and remote-sensing sensors for dam deformation monitoring," *Sensors*, vol. 18, no. 11, p. 3682, 2018.
- [9] J. Yu, X. Meng, B. Yan, B. Xu, Q. Fan, and Y. Xie, "Global Navigation Satellite System-based positioning technology for structural health monitoring: a review," *Struct. Control Heal. Monit.*, vol. 27, no. 1, p. e2467, 2020.
- [10] GOCA, "GOCA - GNSS/LPS/LS-based online Control and Alarm System," *Web Page*, 2022. http://goca.info/index_e.html (accessed Apr. 02, 2022).
- [11] [R. Jäger and F. González, "GNSS/LPS Based Online Control and Alarm System (GOCA) - Mathematical Models and Technical Realization of a System for Natural and Geotechnical Deformation Monitoring and Hazard Prevention," in *Geodetic Deformation Monitoring: From Geophysical to Engineering Roles*, 2006, pp. 293–303.
- [12] D. Rutledge, J. Gnipp, and J. Kramer, "Advances in real-time GPS deformation monitoring for landslides, volcanoes, and structures," in *Proceedings of the 10th FIG International Symposium on Deformation Measurements, Orange, California, March, 2001*, pp. 19–22.
- [13] Leica Geosystems, "Leica GeoMoS Monitoring Solution." <https://leica-geosystems.com/products/total-stations/software/leica-geomos> (accessed Apr. 02, 2022).
- [14] Leica Geosystems, "Leica M-Com mobile communication solution." <https://leica-geosystems.com/products/total-stations/systems/leica-m-com> (accessed Apr. 06, 2022).
- [15] B. Hofmann-Wellenhof, H. Lichtenegger, and E. Wasle, Eds., "Observables BT - GNSS — Global Navigation Satellite Systems: GPS, GLONASS, Galileo, and more," in *GNSS — Global Navigation Satellite Systems: GPS, GLONASS, Galileo, and more*, Vienna: Springer Vienna, 2008, pp. 105–160.
- [16] W. Schofield and M. Breach, *Engineering surveying*. CRC Press, 2007.
- [17] D. Blagojević, *Uvod u Satelitsku geodeziju*. Beograd: Građevinski fakultet Univerziteta u Beogradu, 2014.
- [18] Trimble GNSS Planning." <https://www.gnssplanning.com/#/settings> (accessed Apr. 06, 2022).
- [19] Eneroprojekt Holding a.d., "Braná Soubella, Alžir." <http://www.energoprojekt.rs/brana-soubella-alzir/> (accessed Apr. 03, 2022).

- [20] U.S. Army Corps of Engineers, "Engineering and Design - INSTRUMENTATION OF EMBANKMENT DAMS AND LEVEES," *Web Page*, 2020. https://www.publications.usace.army.mil/Portals/76/Users/182/86/2486/EM_1110-2-1908.pdf?ver=SZ5K1AeyStmXACafxcvJ_g%3D%3D (accessed Apr. 01, 2022).
- [21] Leica Geosystems, "Leica GMX910 Smart Antenna." <https://leica-geosystems.com/products/gnss-systems/smart-antennas/leica-gmx910> (accessed Apr. 06, 2022).
- [22] Leica Geosystems, "Data Transfer Cables." <https://leica-geosystems.com/products/levels/accessories/data-transfer-cables> (accessed Apr. 06, 2022).
- [23] Leica Geosystems, "Data Transfer Cables." <https://leica-geosystems.com/products/construction-tps-and-gnss/accessories/data-transfer-cables> (accessed Apr. 06, 2022).
- [24] Leica Geosystems, "Leica GNSS Spider Software." <https://leica-geosystems.com/products/gnss-reference-networks/software/leica-gnss-spider> (accessed Apr. 09, 2022).

30

Research paper I Оригинални научни рад
DOI 10.7251/STP2215320M
ISSN 2566-4484



Mirjana Milijević, University of Banja Luka, mirjana.milijevic@ef.unibl.org
Asahi Tsuchida, Ikueikan University, tsuchida@wakhok.ac.jp

GEOIDS AS TWO DIMENSIONAL HYPERSURFACES

Abstract

We propose a research of geoids as real hypersurfaces. Moreover, we give adjustment of some classical results on hypersurfaces to CR submanifolds. Our main focus is to study the properties of second fundamental form which give us information on the shape of a hypersurface.

Keywords: geoids, hypersurfaces, shape operator, CR submanifolds.

ГЕОИД ПОСМАТРАН КАО ДВОДИМЕНЗИОНАЛНА ХИПЕРПОВРШ

Сажетак

У овом раду предлажемо проучавање геоида као реалне хиперповрши. Поред тога, показујемо да неки од класичних резултата на хиперповршима вриједје и на Коши-Римановим подмногострукостима. Изучавамо особине друге фундаменталне форме која нам даје информације о облику хиперповрши.

Кључне ријечи: геоид, хиперповрши, оператор облика, Коши-Риманове подмногострукости.

1. INTRODUCTION

The Earth's geoid can be explained as the shape that the ocean surface would take under the influence of the gravity of Earth. That is to say the geoid is an imaginary sea level surface. Together with ellipsoid, the geoid determines one of the geophysical actual shape of the Earth. Geoids are mostly studied in gravitational physics. Moreover, they are used for GPS satellites, for studying climate patterns and related fields. It is interesting to say that such an important object is studied only in the context of Newtonian gravity so far. In the context of general relativity, the authors in [3] obtained the partial differential equation that the geoid satisfies in their observed model of the Earth. A relatively recent research ([5]) gives new method for studying geoids, called quasi local frames. There we can see a representation of geoid as a two dimensional hypersurface. By far, there are no studies of geoids as purely differential geometry objects.

In this paper we give an idea, an open problem, on what information can we get from geoid studied as a hypersurface in an ambient manifold using differential geometry methods. We would like to know what properties geoid hypersurface has, or does it belong to one of the familiar classes of hypersurfaces, such as hypersurfaces from Takagi classification ([7]). Problems like finding principal curvatures, parallelism of the shape operator of the hypersurface normal are of great importance to solve.

We will show one of the famous results on real hypersurfaces in complex space forms and our original result, which gives a generalization to CR submanifolds. In our settings, an ambient manifold is complex space form, i.e. a Kähler manifold of constant holomorphic sectional curvature. The most important examples of complex space forms are complex Euclidean space, complex projective space and complex hyperbolic space.

Let \bar{M} be an $(n + p)$ -dimensional complex space form, i.e. a Kähler manifold of constant holomorphic sectional curvature $4c$, endowed with metric g . Let M be an n -dimensional real submanifold of \bar{M} and J be the complex structure of \bar{M} . For a tangent space $T_x(M)$ of M at x , we put $H_x(M) = JT_x(M) \cap T_x(M)$. Then, $H_x(M)$ is the maximal complex subspace of $T_x(M)$ and is called the holomorphic tangent space to M at x . If the complex dimension $\dim_{\mathbb{C}} H_x(M)$ is constant over M , M is called a Cauchy-Riemann submanifold or briefly a CR submanifold and the constant $\dim_{\mathbb{C}} H_x(M)$ is called the CR dimension of M . If, for any $x \in M$, $H_x(M)$ satisfies $\dim_{\mathbb{C}} H_x(M) = \frac{n-1}{2}$ then M is called a CR submanifold of maximal CR dimension. It follows that there exists a unit vector field ξ normal to M such that $JT_x(M) \subset T_x(M) \oplus \text{span}\xi_x$, for any $x \in M$.

A real hypersurface is a typical example of a CR submanifold of maximal CR dimension. The study of real hypersurfaces in complex space forms is a classical topic in differential geometry and the generalization of some results which are valid for real hypersurfaces to CR submanifolds of maximal CR dimension may be expected. For instance, nonexistence of real hypersurfaces with the parallel shape operator and real hypersurfaces with the second fundamental form satisfying $h(JX, Y) - Jh(X, Y) = 0$, in nonflat complex space forms, is proven.

In this paper we study the conditions that the shape operator of the distinguished vector field ξ is parallel on CR submanifolds of maximal CR dimension in complex space forms.

Our paper is organized as follows. In the first part we give some basic definitions and properties of hypersurfaces and geoids. After that, a generalization of the famous result of R. Niebergall and P.J. Ryan ([4]) is given.

2. PRELIMINARIES

2.1. GEOIDS

The gravity on the Earth is defined as a resultant force of universal gravitational attraction and Earth's rotation;

$$\text{grad}W = \text{grad}U + \text{grad}\Phi,$$

where W is the potential function of gravity, U is the potential of universal gravitation and Φ is the potential of the rotational force of the Earth.

Definition 2.1. For a function $f: U \subset \mathbb{R}^3 \rightarrow \mathbb{R}$ the level surface of value c is the surface S in U on which $f = c$.

Equipotentials are surfaces of constant gravitational potential. The Earth's gravity potential field contains infinity many level surfaces, which are parallel to each other. The geoid is one of those surfaces with a special potential value. Let U_0 be a potential of reference ellipsoid, of which level

surface well approximate the mean sealevel (a “tentative geoid”). Then geoid is defined as the level surface $W = U_0$ (See Figure 1).

Usually, the potential function of gravity is calculated by considering Dirichlet problem with regarding geoid locally as a sphere. Then the potential is given as a surface spherical harmonics with undetermined coefficients. To determine the coefficients, we need surveys of position and gravity anomaly.

Satellite orbit analysis and steady gravity survey enable us to map the geoid accurately ([6]) (See Figure 2). You can read more on mathematical geodesy in [2].

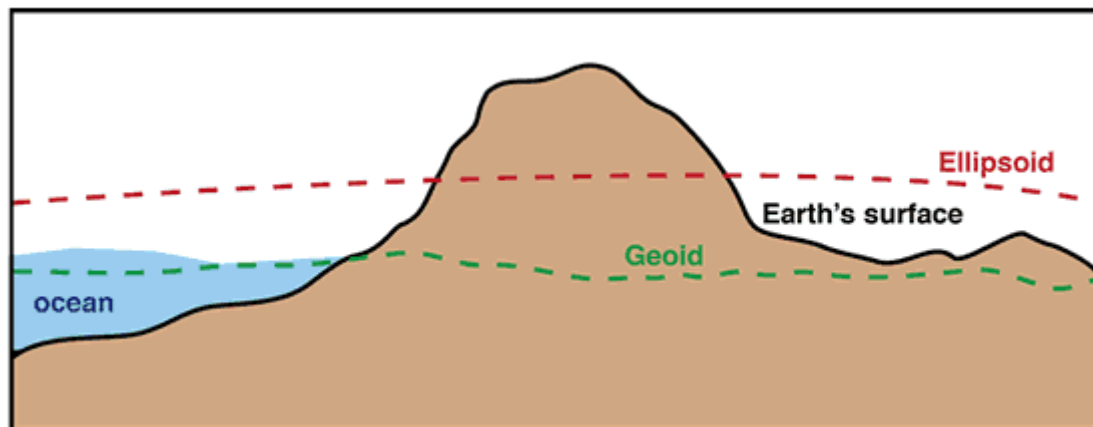

Figure 1. Contrast of the Geoid model with an Ellipsoid and cross-section of the Earth's surface (from a webpage of US government: <https://www.usgs.gov/>)

Figure 2. Global Geographical Mapping of Geoid (from the webpage of International Centre for Global Earth Model: <http://icgem.gfz-potsdam.de/home>)

2.2. REAL HYPERSURFACES AND CR SUBMANIFOLDS

Let \bar{M} be an $(n + p)$ -dimensional complex space form with Kähler structure (J, \bar{g}) and of constant holomorphic sectional curvature $4c$. Let M be an n -dimensional CR submanifold of maximal CR dimension in \bar{M} and $\iota: M \rightarrow \bar{M}$ an immersion. Also, we denote by ι the differential of the immersion. The Riemannian metric g of M is induced from the Riemannian metric \bar{g} of \bar{M} in such a way that $g(X, Y) = \bar{g}(\iota X, \iota Y)$, where $X, Y \in T(M)$. We denote by $T(M)$ and $T^\perp(M)$ the tangent bundle and the normal bundle of M , respectively.

On M we have the following decomposition into tangential and normal components:

$$J\iota X = \iota FX + u(X)\xi, \quad X \in T(M). \quad (1)$$

Here F is a skew-symmetric endomorphism acting on $T(M)$ and $u: T(M) \rightarrow T^\perp(M)$.

Since $T_1^\perp(M) = \{\eta \in T^\perp(M) | \bar{g}(\eta, \xi) = 0\}$ is J -invariant, from now on we will denote the orthonormal basis of $T^\perp(M)$ by $\xi, \xi_1, \dots, \xi_q, \xi_1^*, \dots, \xi_q^*$, where $\xi_{a^*} = J\xi_a$ and $q = \frac{p-1}{2}$. Also, $J\xi$ is the vector field tangent to M and we write

$$J\xi = -\iota U. \quad (2)$$

Furthermore, using (1), (2) and the Hermitian property of J implies

$$F^2 X = -X + u(X)U, \quad (3)$$

$$FU = 0, \quad (4)$$

$$g(X, U) = u(X). \quad (5)$$

Next, we denote by ∇ and $\bar{\nabla}$ the Riemannian connection of M and \bar{M} , respectively, and by D the normal connection induced from $\bar{\nabla}$ in the normal bundle of M . They are related by the following Gauss equation

$$\bar{\nabla}_{\iota X} \iota Y = \iota \nabla_X Y + h(X, Y), \quad (6)$$

where h denotes the second fundamental form, and by Weingarten equations

$$\bar{\nabla}_{\iota X} \xi = -\iota AX + D_X \xi = -\iota AX + \sum_{a=1}^q \{s_a(X)\xi_a + s_{a^*}(X)\xi_{a^*}\}, \quad (7)$$

$$\bar{\nabla}_{\iota X} \xi_a = -\iota A_a X + D_X \xi_a = -\iota A_a X - s_a(X)\xi + \sum_{b=1}^q \{s_{ab}(X)\xi_b + s_{ab^*}(X)\xi_{b^*}\}, \quad (8)$$

$$\bar{\nabla}_{\iota X} \xi_{a^*} = -\iota A_{a^*} X + D_X \xi_{a^*} = -\iota A_{a^*} X - s_{a^*}(X)\xi + \sum_{b=1}^q \{s_{a^*b}(X)\xi_b + s_{a^*b^*}(X)\xi_{b^*}\}, \quad (9)$$

where the s 's are the coefficients of the normal connection D and $A, A_a, A_{a^*}; a = 1, \dots, q$, are the shape operators corresponding to the normals ξ, ξ_a, ξ_{a^*} , respectively. They are related to the second fundamental form by

$$h(X, Y) = g(AX, Y)\xi + \sum_{a=1}^q \{g(A_a X, Y)\xi_a + g(A_{a^*} X, Y)\xi_{a^*}\}. \quad (10)$$

Since the ambient manifold is a Kähler manifold, using (1), (2), (8) and (9), it follows that

$$A_{a^*} X = FA_a X - s_a(X)U, \quad (11)$$

$$A_a X = -FA_{a^*} X + s_{a^*}(X)U, \quad (12)$$

$$s_{a^*}(X) = u(A_a X), \quad (13)$$

$$s_a(X) = -u(A_{a^*} X), \quad (14)$$

for all X, Y tangent to M and $a = 1, \dots, q$.

Moreover, since F is skew-symmetric and A_a and $A_{a^*}; a = 1, \dots, q$, are symmetric, (11) and (12) imply

$$g((A_a F + FA_a)X, Y) = u(Y)s_a(X) - u(X)s_a(Y), \quad (15)$$

$$g((A_{a^*} F + FA_{a^*})X, Y) = u(Y)s_{a^*}(X) - u(X)s_{a^*}(Y), \quad (16)$$

for all $a = 1, \dots, q$. Finally, the Codazzi equation for the distinguished vector field ξ becomes of the following form

$$\begin{aligned}
 (\nabla_X A)Y - (\nabla_Y A)X &= c\{u(X)FY - u(Y)FX - 2g(FX, Y)U\} + \sum_{a=1}^q \{s_a(X)A_a Y - s_a(Y)A_a X\} \\
 &+ \sum_{a=1}^q \{s_{a^*}(X)A_{a^*} Y - s_{a^*}(Y)A_{a^*} X\} \tag{17}
 \end{aligned}$$

for all X, Y tangent to M .

3. CR SUBMANIFOLDS WITH PARALLEL SHAPE OPERATOR

Here, we will give one well known result about hypersurfaces with the parallel shape operator.

Theorem 3.1. Let M be an n -dimensional, where $n \geq 3$, hypersurface in a complex space form of constant holomorphic sectional curvature $4c \neq 0$. Then the shape operator A of M cannot be parallel. We will study the same condition on CR submanifolds of maximal CR dimension in complex space forms. Therefore, we have the next two theorems.

Theorem 3.2. Let M be an n -dimensional CR submanifold of maximal CR dimension in an $(n + p)$ -dimensional complex space form (\bar{M}, J, \bar{g}) , where $n \geq 3$ and the constant holomorphic sectional curvature of \bar{M} equals $4c$. Let the distinguished vector field ξ be parallel with respect to the normal connection D and A be the shape operator of ξ . If $\nabla A = 0$ on M , then \bar{M} is a Euclidean space.

Proof. Putting $Y = U$ in Codazzi equation (17), we get

$$(\nabla_X A)Y - (\nabla_Y A)X = -cFX + \sum_{a=1}^q \{s_a(X)A_a U - s_a(U)A_a X\} + \sum_{a=1}^q \{s_{a^*}(X)A_{a^*} U - s_{a^*}(U)A_{a^*} X\}.$$

From the assumption of the theorem and the last equation, we get

$$cFX = 0,$$

from which we conclude that $c = 0$. \square

Theorem 3.3. Let M be an n -dimensional CR submanifold of maximal CR dimension in an $(n + p)$ -dimensional complex space form (\bar{M}, J, \bar{g}) , where $n \geq 3$ and the constant holomorphic sectional curvature of \bar{M} equals $4c$. Let $p < n$ and A be the shape operator of the distinguished vector field ξ . If $\nabla A = 0$ on M , then \bar{M} is a Euclidean space.

Proof. After putting $Y = U$ in (17) and using the assumption of the theorem, we get

$$-cFX + \sum_{a=1}^q \{s_a(X)A_a U - s_a(U)A_a X\} + \sum_{a=1}^q \{s_{a^*}(X)A_{a^*} U - s_{a^*}(U)A_{a^*} X\} = 0. \tag{18}$$

After multiplying the equation (18) by an arbitrary $Y \in T(M)$, we get

$$\begin{aligned}
 &-cg(FX, Y) + \sum_{a=1}^q \{s_a(X)g(A_a U, Y) - s_a(U)g(A_a X, Y)\} \\
 &+ \sum_{a=1}^q \{s_{a^*}(X)g(A_{a^*} U, Y) - s_{a^*}(U)g(A_{a^*} X, Y)\} = 0. \tag{19}
 \end{aligned}$$

Interchanging X and Y in (19) and subtracting (19) and the resulting equation, we get

$$\begin{aligned}
 &-2cg(FX, Y) + \sum_{a=1}^q \{s_a(X)g(A_a U, Y) + s_{a^*}(U)g(A_{a^*} U, Y)\} \\
 &+ \sum_{a=1}^q \{s_a(Y)g(A_a U, X) + s_{a^*}(Y)g(A_{a^*} U, X)\} = 0. \tag{20}
 \end{aligned}$$

Now, using (5), (13) and (14), from the last equation it follows that

$$cFX = \sum_{a=1}^q \{s_{a^*}(X)A_{a^*}U + s_a(X)A_aU\}. \quad (21)$$

On the other hand, if we put

$$0 = \sum_{a=1}^q \{c_{a^*}(X)A_{a^*}U + s_a(X)A_aU\}, \quad (22)$$

where c_{a^*} and c_a are constants; $a = 1, \dots, q$, by scalar multiplication of (22) with an arbitrary $X \in T(M)$ using $\bar{g}(\iota A_a X, \iota Y) = \bar{g}(h(X, Y), \xi_a)$, $\bar{g}(\iota A_{a^*} X, \iota Y) = \bar{g}(h(X, Y), \xi_{a^*})$; $a = 1, \dots, q$, and (6), it follows that

$$0 = \sum_{a=1}^q \{c_{a^*} \bar{g}(\bar{\nabla}_U X, \xi_{a^*}) + c_a \bar{g}(\bar{\nabla}_U X, \xi_a)\},$$

i.e.

$$0 = \sum_{a=1}^q \{c_{a^*} \xi_{a^*} + c_a \xi_a\}.$$

From the last equation and the fact that $\xi_{a^*}, \xi_a, a = 1, \dots, q$, are linearly independent, it follows that $c_{a^*} = c_a = 0$; $a = 1, \dots, q$. Then, we can conclude that $A_{a^*}U, A_aU$; $a = 1, \dots, q$, are linearly independent vector fields. It is known that $\text{rank } F = n - 1$ (see [1]), that is why from (21) it follows that there exist a vector field $Y \in T(M)$ such that $Y = FX$ and that Y is orthogonal to the vector fields $A_aU, A_{a^*}U$; $a = 1, \dots, q$. Multiplying (21) with $Y = FX$, we get

$$cg(FX, FX) = 0,$$

from which we conclude that $c = 0$. \square

LITERATURE:

- [1] M. Djorić and M. Okumura, CR submanifolds of complex projective space. Berlin: Springer, 2009.
- [2] M. Hotine, Mathematical Geodesy. U.S.: U.S. Government Printing Office, 1969.
- [3] S. Kopeikin, E. Mazurova, and A. Karpik, "Towards an exact relativistic theory of Earth's geoid undulation", Phys.Lett., vol. A379, pp. 1555-1562, 2015.
- [4] R. Niebergall and P.J. Ryan, "Real hypersurfaces in complex space forms", Tight and Taut Submanifolds, vol. 32, pp. 233-305, 1997.
- [5] Marius Oltean et al, "Geoids in general relativity: geoid quasilocal frames", Class. Quantum Grav., vol. 33, 2016.
- [6] E. Sinem Ince et al, "ICGEM - 15 years of successful collection and distribution of global gravitational models, associated services, and future plans", Earth Syst. Sci. Data, vol. 11, pp. 647-674, 2019.
- [7] R. Takagi, "Real hypersurfaces in a complex projective space with constant principal curvatures", J. Math. Soc. Japan, vol. 27, 1975.



Igor Jokanović, Faculty of Civil Engineering, Subotica, jokanovici@gf.uns.ac.rs

Selma Ljubijankić, Consultant, selma-ljubijankic@hotmail.com

GENDER DIFFERENTIATION OR EQUALITY IN TRANSPORT PROJECTS: CASE STUDY ROAD SECTOR MODERNIZATION IN THE FEDERATION OF BOSNIA AND HERZEGOVINA

Abstract

Transport projects provide us with better, faster roads, save travel times, but also lead to occurrences of health and safety risks. Data shows that males are the group that are most affected by such risks. However, they become far less cooperative when confronted with this fact. At the same time, women are the group that is more likely to accept new methods or ideas concerning road projects. They are also more focused on road safety and concerned about associated community health and safety risks. Yet, women are far less involved in any kind of official interaction, and that is why their scope of interest is more likely to be neglected. The paper analyzes how transport projects affect differently women and men and presents recommendations to improve benefits for both genders.

Keywords: gender, equality, transport, roads, beneficiaries

POLNE RAZLIKE ILI JEDNAKOST U SAOBRAĆAJNIM PROJEKTIMA: STUDIJA SLUČAJA MODERNIZACIJA PUTNOG SEKTORA U FEDERACIJI BOSNE I HERCEGOVINE

Сажетак

Саобраћајни пројекти нам пружају боље путеве, којима ћемо се брже кретати, скраћују вријеме путовања, али исто тако доводе и до појаве здравствених и безбедносних ризика. Подаци показују да су мушкарци група која је највише под утицајем таквих ризика. Међутим, они постају далеко мање кооперативни када се суоче са овом чињеницом. У исто вријеме, жене су група која лакше прихвата нове методе или идеје које се тичу путних пројеката. Такође су више оријентисане на безбједност саобраћаја и показују већи ниво забринутости за повезане ризике по здравље и безбједност заједнице. Ипак, жене су далеко мање укључене у било какву званичну интеракцију и зато је вјероватно да ће њихов интерес бити занемарен. Рад анализира како транспортни пројекти различито утичу на жене и мушкарце и даје препоруке за побољшање користи за оба пола.

Кључне ријечи: пол, једнакост, саобраћај, путеви, корисници

1. INTRODUCTION

Social learning theory [1] defines gender as a self-perceived sense of maleness or femaleness that is learnt through socialization and education and is socially determined by society's expectations of the roles of men and women. Gender equality refers to equality under the law, equality of opportunity (rewards for work, equality of access to human capital, and other productive resources), and equality of voice (ability to influence and contribute to the development process) [2].

In Bosnia and Herzegovina (B&H) two laws prohibit any kind of gender-based discrimination, namely: the Law on Gender Equality and the Law on Prohibition of Discrimination in B&H.

Despite this, the construction industry in B&H is the most male-dominated sector, same as throughout the world. Men dominate senior technical operational roles, while women tend to be in more junior support roles, safeguards, human resources, and marketing. Traditionally, construction activities fall into the categories of economy in which women have been prejudiced as lacking the skill, talent, and ability to make a successful career. The research [3] finds that women's careers are being stymied by rigid work practices, long hours and an expectation of total availability, lack of flexible parental leave (in practice), tolerance of sexism and accepted informal recruitment processes that favor men. Women at the top of the corporate ladder are conspicuous by their absence, hampered in their career journey by inflexible working environments, bias (unconscious or not), and perceptions of limited opportunities. This is not just a problem for women and their aspirations; it is a problem for the whole sector.

According to Construction News [4], half of all construction firms claim they have never had a female manager within their business - a shocking figure when gender diversity and equality is such a pressing issue. Furthermore, when asking the women who did work within the industry, 48% claimed they had experienced gender discrimination in the workplace, with the most common example of this (28%) being inappropriate comments or behavior from male colleagues. These are figures that prove that the industry still needs to enforce more regulations and ethics to change attitudes towards women in the industry and encourage equality. When it comes to on-site construction workers, statistics reveal that 99% of roles are filled by males. Another figure that highlights the lack of gender diversity within the industry. Despite the figures, 93% of construction workers believe having a female boss would not affect their jobs or would in fact have a positive effect by improving the working environment.

Since the launching of the United Nation's Decade for Women (1975-1985), the world has witnessed tremendous focus on gender equality and empowerment of women as means of increasing productivity and enhancing the socio-economic status of nations. The need for unbiased utilization of human resources has given research impetus to gender participation in various economic endeavors in both the developed and the developing countries. As part of the strategies particularly for the construction sector, the United Nations directed members' nations to [5]:

- Encourage enrolment of women in architectural, engineering and related fields;
- Assign professional policy-making and decision-making positions to qualified women graduates in the relevant fields;
- Provide women with construction, maintenance and management skills;
- Include women in related training and educational programs.

United Nations Economic Commission for Europe [6] emphasized the topic of gender and transport as a multifaceted one. Major differences exist in the basic mobility needs of women and men. These differences are grounded in the gender-based division of labor within the family and community. Transport can make a big difference in increasing women's productivity and promoting gender equality. Beside transport-related workers, most transport agencies, boards, and advisory committees at all levels are principally managed by males. In addition to its major contribution to economic growth, transport plays a crucial role in socially sustainable development by broadening access to health and education services, employment, improving the exchange of information, and promoting social cohesion. At the same time, various activities involved in construction, maintenance, rehabilitation, or improvement of transport infrastructure provide major opportunities for involvement and professional advance of female; thus, it is considered as a kind of tool for reaching equality.

The construction industry, and roads particularly for the past two decades, is the largest employer of labor in the Western Balkans region. Unfortunately, there has been no serious research into women participation in construction. The objective of the paper is not to report findings on the utilization of female resource in the construction industry and the road sector. To the contrary, the authors wish to highlight, based on the experience gained in B&H within the past few years, certain

activities and processes that can benefit from the participation of women in their realization - from project preparation, through communication with stakeholders, to physical realization itself and supervision over the execution of the works.

The intention is to offer decision makers at senior levels (both in public and private sectors) an opportunity to broaden their horizon towards adopting innovative strategies to human resource management in order to reverse the current trend of underutilization of female talent in the construction profession, and one of its major contributors - the road sector.

2. FEDERATION OF BOSNIA AND HERZEGOVINA CASE STUDY

B&H's transport infrastructure is rated as the poorest among Southeast Europe (SEE) and European Union-Central Eastern Europe (EU-CEE) countries by the World Economic Forum (WEF) [7]. In 2015-16, B&H scored 2.2 out of 7 on the WEF's Global Competitiveness Indicator (GCI) for quality of infrastructure, lower than the SEE average of 2.9 and the EU-CEE average of 4.5. The Logistics Performance Index (LPI) similarly rates B&H as having below SEE average infrastructure (2.55 out of 5 compared with a regional average of 2.65) and standards significantly below those of the EU-CEE. Transport infrastructure improvements are necessary for the country to take advantage of its geographical position next to the world's largest market and increase exports and export-related employment.

To answer this task, at least within its jurisdiction, the Public Company Roads of Federation of B&H (PC Roads FB&H) has initiated an overarching program of modernizing the main roads within the territory of the Federation of Bosnia and Herzegovina (FB&H) to ensure appropriate road infrastructure by 2022. For this purpose, the Government of FB&H has ensured credit funds from International Financing Institutions (IFIs).

FB&H Road Sector Modernization Project (hereinafter referred to as the Project) comprises several small and mid-sized investment schemes including:

- Reconstruction of roads (construction of roads and lanes for low-speed vehicles, reconstruction/improvement of tunnels, bridges and carriageways),
- Interventions on improving road safety (reconstruction of crossroads and black spots),
- Institutional reforms, and
- Project implementation support (construction supervision and capacity building of the PC Roads FB&H).

The Project is being implemented mainly in poor peri-urban and rural communities with low population density. The social aspects of the Project were categorized as category A (as per the World Bank safeguards rating), mainly because of the large scope of land acquisition. Other than land acquisition, the Project's social impacts are expected to be largely positive. The Project is expected to have a particularly positive impact on the population of affected municipalities. The improved connectivity will facilitate closer access to jobs, services and stimulate trade, tourism, and linked services. The elimination of black spots on selected roads will reduce the severity of traffic accidents.

The Project's beneficiaries can be divided into two groups:

- Group 1: Citizens of affected municipalities and road users;
- Group 2: Staff working on the Project.

To fully answer the needs of both groups of beneficiaries as well as to harness local knowledge that can benefit the Project to the largest possible amount, the question of gender could not be disregarded neither through the Project's preparation nor through the implementation.

Moreover, to be able to monitor how the Project affects men and women project performance indicators, monitoring both groups of beneficiaries, have been gender desegregated.

2.1. THE QUESTION OF GENDER IN THE FIRST GROUP OF BENEFICIARIES

The first group of beneficiaries is monitored by the 'Number of Road Users' indicator. This indicator is being tracked by traffic counting devices scattered throughout the main road network in FB&H. Since the traffic counting devices cannot differentiate the gender of road users it was agreed to use the male to female population of B&H rate, which equals 49:51%.

When considering citizens of local communities and road users in B&H, it is important to consider that men and women have different needs. Women are historically more connected to the household, running family errands and in general are more prone to communicating lesser distances than men. Men, on the other hand, tend to travel greater distances and reaching further away from the household. That is why women are more affected by local traffic while conditions of transit traffic

take a bigger toll on men's life. Hence, females' interests are more expressed when it comes to topics such as road safety and everyday life impacts on local communities. Men, however, are more interested in allowed driving speed after the reconstruction, saving travel time, alternative routes, etc.

Moreover, it is known that men are more frequently involved in traffic accidents than women. Based on the Traffic Safety Basic Facts Study [8], 74% of road fatalities out of all traffic accidents in the EU were men. This means the road fatality rate of males in 2014 was more than three times the respective female rate. According to the same study, road fatalities gender differences are most evident in the age group 18-44, where the fatality rate of males peaks to 84% of all road fatalities. The EU related analysis of 2014 data on road users' types in fatal road accidents concluded that only 35% of female fatalities were drivers, compared to 70% of males. When comparing the given data of EU, road safety rates disaggregated by gender, country, and GDP (Gross Domestic Product) of same EU countries, we get the expected result. GDP and road fatalities are inversely proportional - the lower the GDP of a country the higher the number of road fatalities and the bigger the road fatality gender differences. Since B&H's GDP per capita (5,180.64 USD) is significantly lower than the EU (37,800.00 USD) it can be concluded that the above figures are even more extreme in B&H. This makes men, especially young men aged 18 to 44, in low-income countries [9], such as B&H, a vulnerable category considering road safety.

To appropriately address all questions concerning local communities, PC Roads FB&H organizes public meetings with affected communities for each of the 32 subprojects, usually right before the commencement of works. These public meetings are either very well (around 30% of all meetings) or very poorly (around 70% of all meetings) attended. Either way, all the meetings have the following in common:

- The moment the male vulnerability regarding traffic safety is brought up, men stop to cooperate and become far less friendly;
- Male to female attendees' ratio equals 80:20%;
- Only 1 in 10 women actively participates in the meetings.

In pursuance of mitigating the risk of neglecting women's opinion and overseeing their needs comprised in the Project, PC Roads FB&H organized special focus groups for women in the most affected municipalities. Those meetings were held during the Project preparation phase in order to be able to minimize potential risks and integrate solutions into operational implementation documents such as environmental and social action plans or even project designs.

The questions raised during these meetings were utterly different from the ones raised during classic public consultations. Women from local communities talked and asked questions about:

- Safety issues such as securing the construction site from children;
- Health and safety matters that can affect their community such as irresponsible disposal of construction waste inducing possible health issues;
- Labor influx and whether they would be safe from gender based violence;
- Their rights during the land acquisition process;
- Impacts during construction such as alternatives for school transportation and how the Project would affect the transportation of goods to grocery stores.

Furthermore, surprisingly, the question of male vulnerability considering road safety was raised during women's focus groups. The topic of future road safety measures has been discussed and mitigation measures have been suggested by women from local communities.

It seems as if different approach to different gender groups was an utmost success for the Project and helped the PC Roads FB&H's team in revealing different social, community health and safety, and road safety risks, as well as defining appropriate and tailored mitigation measures.

2.2. THE QUESTION OF GENDER IN THE SECOND GROUP OF BENEFICIARIES

The second group of beneficiaries is monitored by the gender segregated 'Job Creation' indicator. The Project consists of 32 subprojects of which 20 subprojects are currently under construction, 7 have been already finished and 5 are yet to be started. For now, the Project affected 8 construction companies which have or had signed contracts, and 5 supervision consultancy firms (two consultancy contracts, as detailed below). Considering the whole group, for now 546 people were involved in the Project preparation and implementation (excluding the PC Roads FB&H's team and Project designers) out of which 482 (88%) are men and 64 (12%) are women. Although women usually tend to occupy subsidiary positions in construction projects and are less represented in engineering and decision-making positions, the Project employs 23 skilled/qualified women, which equals to 37% of all female workforce.

Furthermore, amongst the 546 people engaged with the Project, 97 were employed by selected contractors directly from local communities to contribute to the Project implementation. Only 7 of them are women and are all unqualified. The cause to this (at the first sight) shocking data is that most of the jobs offered by construction companies to local community members are hard physical jobs that women, historically and biologically, are not used to perform (like guards at the construction site, site labor, etc.). Instead, women from local communities are usually employed for either administrative tasks (such as assistants and secretaries) or less heavy physical work (such as cleaners or cooks).

To illustrate the different approach men and women have towards gender issues with the Project, the authors will present a real-life comparison of a male and female occupying exactly the same job position within the Project:

- Two supervision teams have been set out for the Project. Team A (comprised of 2 firms) supervises one subproject with major works in new construction, while Team B (comprised of 3 firms) supervises the other 31 subprojects;
- Both supervision teams have, amongst their staff, an appointed social specialist whose duty it is to monitor the above mentioned gender segregated social performance indicators and to report on grievances. Team A employs a man as the social specialist, while Team B employs a woman;
- During the course of the Project, it has been noted that the reports comprised by the Team B's social expert are more detailed, precise and sent in a timelier manner, while the reports sent by social specialist from the Team A are generally more sloppy and usually drafted without previous due diligence with mostly highly general statements;
- The same type of difference is also visible in the actual actions of these two specialists and approach to locals as well as to labor.

Although this case can very well be a random coincidence since it compares just two samples, it is the authors' opinion that women are generally more goal oriented and devoted to the objective of social and environmental responsibility which makes them a great solution for safeguard specialists, both social and environmental.

3. LESSONS LEARNED

Female resource presents about half of B&H's human resources, while at the regional level (Western Balkans) it is between 40 and 50%, depending on the country. For this reason, inclusiveness must be a priority for construction industry to which the road sector contributes significantly. It is irreparable damage to give up such potential, which is found in almost half of the region's population.

Females are in general rarely employed as labor, more frequently as administrative and engineering staff. However, administrative activity is dominant. This can be attributed partly to traditional belief that the discipline is strictly for men and partly due to inability of women to perform some tasks requiring physical exertion of strength. Major aspects of construction works are site based. Therefore, it is required that certain cadres of workers (site managers, project supervisors, foremen, craftsmen, and laborers) are physically fit to withstand rugged site conditions pervaded by noise, dust, and vibrations. This is in addition to lifting heavy objects, climbing, fixing components, and operating plants and equipment. Men are considered to be more physically fit for site conditions and the accompanying tasks, risk and health hazards.

Although tasks like construction progress evaluation, project supervision, setting out and site reconnaissance are less physically exerting and hence ranked next to indoor tasks, they still involve staying in the open sun for hours; a situation which many women professionals express inability to cope with as much as their male counterparts for biological reasons. Slightly different is the case of supervision activity in the field where females are usually employed as safeguards experts, contract and claim specialists, and to a lesser extent as supervisors for road or structural works.

The productivity of women can compare favorably with that of men in office related construction activities such as administration, estimating and tendering and preparation of working drawings, which involves less physical energy. In view of other consulting services, design as an example, females and males are mostly equally presented in the respective teams for delivery of technical outputs. It is clear that the well-being of their employees is paramount to the survival of construction consultancy companies because people are their only asset; thus, the proper conditions must be set to preserve the staff, and this may be the main reason why many of females decide to enter the world of consultancy companies instead of construction companies.

Still, men continue to predominate in decision-making in the sector. This means there is an unbalanced participation of women and men in planning, design, supervision, and construction related activities, and deciding on actions, which may affect both women and men practitioners and citizens.

Although marital status should not be and is least used for recruitment, some married women are reportedly reluctant to relocate to new sites far away from the headquarter. Again, the case for consultancy companies.

For optimal utilization of resources, gender equality, it is considered that women should be adequately represented in the construction industry which is the largest employer of labor in the country. Our changing environment requires nothing less than reshaping the way we grow and build. Gender diversity is good for business by increasing innovation, productivity, and profitability. However, without the right knowledge, many women will continue to believe that the construction is limited to working on a building site. Also, it is the fact that women are not part of any initiatives that will help them progress to senior position. This highlights the need for more programs to help encourage women to get involved, as well as greater advertising that current programs are available. However, the issue of women must be equally tackled at the level of younger girls and school leavers, as well as at the level of elderly women.

At the same time, it must be mentioned that females enrolling to engineering studies are aware they are entering the male-dominated field. Students are generally prepared for the realities of the profession, including male environment, working hours, compensations, as well as benefits in the form of insurance, bonuses, and advance in certain areas. At this moment, and in view of conditions prevailing in B&H, it is interesting to note the results of an interview with female students conducted by Powell et al. [10]. Students were asked about their changing behavior and any coping strategies that they had developed. An interesting comment was "it is actually a case of everyone else getting used to you rather than adjusting your own behavior". That interviewee went further to imply that to act "too feminine" might affect how colleagues treat you, "as long as you don't go out there thinking that you're going to get special treatment, it's all fine". As if the interview was done with a female student or engineer in B&H.

Communication style is dominated by masculinities, with high levels of confrontation followed by appeasement in men-to-men conflict. Similarly to findings of Galea and Loosemore [1], the road projects in B&H showed lower levels of escalation of confrontation and aggression when females are involved, either within the technical teams or when there is an interaction with stakeholders and public.

The experience gained for the past few years, particularly during public consultations, safeguards development and monitoring, shows that engaging women as equally as men in planning and decision-making increases their practical experience and usually increases the capacity of public to understand the problem and reach feasible solutions.

The following quote from the recent interview with, Cristina Savian (CEO and founder of BE-WISE) [11], literally presents the situation of females in construction industry, as well as in the road sector in B&H: "In my 20-year career in civil engineering and technology, I have been often felt out of place, not only because I was the only woman around, but often because I was getting asked: Why do you work in civil engineering? Too often I was told I did not belong, because of the way I look, because of my funny accent and most of all because, I was often the only person in the room who had a different line of thought. This is what I learnt, do not allow anyone to tell you if you belong or not to this industry, you know if you are already." This does not concern only females working for contractors or consultants, but also women as representatives of the society.

When dealing with the beneficiaries at the local community, it is clear that differentiation exists in respect to expected results of any project. Principally, women are more concerned with health, safety, and security, as well as with the local access to education, health and markets. Furthermore, specific focus groups for women revealed their real worries and expectations.

Finally, it is a well-known fact that monitoring and evaluation is an important management tool. In order to ensure progress and increase gender equality, specific gender related performance indicators are needed, e.g. number and percentage of female workers, number and percentage of female beneficiaries, including their structure by occupation and duties. Gender indicators track progress toward reducing gender differentiation in project implementation and business opportunities. Within this field, significant support comes from the IFIs and their approach to gender equality.

At this moment, knowing the level of development in respect to gender issues in general and particularly in the construction sector, but also following the experience from the road modernization in the FB&H, the authors may propose the following recommendations and forward actions:

- In view of the available resource and potential for different approach in comparison to the classic male view, it is necessary to continue promotion of the engineering profession among female population through actions within the high school and advertising for advance and specialization among elderly female engineers;
- Gender equality is hard to force or enforce. To the contrary, it must be understood as the feeling and relationship that comes through cooperation and time, and the efforts coming from the women must be praised and supported by their male counterparts;
- Certain elements of differentiation will always exist since the construction, and road business as its part, normally mean harder physical jobs that women biologically cannot perform. However, at the same time, when speaking about workers in the field, women can perform certain jobs (e.g. truck drivers, machine operators, and similar) as equal as men;
- Construction companies, as well as local communities and governments, should be encouraged to organize or promote courses for prequalification for women in order to make them more competitive on the construction labor market;
- Greater involvement and even better results may be expected in the field of consulting services, in particular design, supervision and contract management. More specifically, the safeguards field (environment, social, community and occupational health and safety, etc.), engineering reporting, and similar are the fields that can significantly benefit from the different approach and views expressed by women. This comes from the fact that women are, in general, more devoted and passionate in respect to set objectives, results and rules;
- Gender oriented focus groups provide a mean for grater inclusion of women in transport related issues in the environments such as B&H and can be utilized as convenient tool to support community health and safety and to provide better adherence to development goals at the local level.

4. CONCLUSION

Despite the existence of legislation that prevents gender-based discrimination, the construction industry continues to remain a male-dominant sector in B&H, as well as in the rest of the world. The presented shocking figures of 48% of women who experienced gender discrimination while working in the construction industry prove that the sector needs to enforce stricter regulations to change the attitude towards women and encourage not only equality but more importantly equity.

This paper, in its attempt of mainstreaming gender issues in the sector, presented the FB&H case study through the implementing agency's experiences during the project for modernization of the main roads in FB&H.

Presented case study shows that it is highly recommended to endorse different approaches towards men and women during the process of citizen engagement. Only by doing this can the project truly benefit from the largest possible amount of local knowledge which is needed to define and mitigate different kind of risks (social, community health and safety, road safety, etc.).

Furthermore, it showed that although women are, proportionately to their number in the industry, well represented in the administrative and engineering staff, while the labor portion of the work market is still, pretty much, a taboo in the sector, even though jobs that women can biologically perform do exist (truck drivers, machine operators, and similar).

Women represent 51% of B&H's population. The low-income economy of the country with tremendously high rate of emigration, cannot afford to give up on half of its possible employees in any industry due to obsolete principles of gender segregation.

Hence, the authors presented recommendations and forward actions which, if implemented, could significantly improve the female position in the B&H construction industry and open a completely new job market for women.

ACKNOWLEDGEMENTS

The presented paper is the result of work done by the Public Company Roads of the Federation of Bosnia and Herzegovina in implementing social safeguards during the Road Modernization Project in the Federation of Bosnia and Herzegovina supported by the World Bank and the European Investment Bank. The authors are grateful for efforts and understanding of all the authorities who approved the use of the data.

LITERATURE

- [1] N. Galea and M. Loosemore, "Men and conflict in the construction industry", *Proceedings of the 22nd Annual ARCOM Conference*, Birmingham, 2006, pp. 843-850
- [2] The World Bank, *Making Transport Work for Women and Men, Tools for Task Teams*, Washington, D.C., 2010.
- [3] F. Smith. "Construction industry becoming increasingly gender-segregated, report finds." *The Guardian* (2016) Internet: <https://www.theguardian.com/sustainable-business/2016/dec/12/construction-industry-becoming-increasingly-gender-segregated-report-finds> [January 20, 2022]
- [4] NiftyLift. "Gender diversity in the construction industry" *Construction Global* (2018) Internet: <https://www.constructionglobal.com/mission-critical/gender-diversity-construction-industry> [January 20, 2022]
- [5] United Nations, *Report of the World Conference to Review and Appraise the Achievements of the United Nations Decade for Women: Equality, Development and Peace*, New York, 1985.
- [6] UNECE, *The Inland Transport Committee and gender issues in transport*, Geneva, 2009.
- [7] The World Bank. (2015) "Project Appraisal Document on a loan to Bosnia and Herzegovina for the Federation Road Sector Modernization Project", Available: <http://documents.worldbank.org/curated/en/578091470316881206/pdf/PAD1648-PAD-P152406-R2016-0146-1-Box396277B-OUO-9.pdf> [January 15, 2022]
- [8] European Road Safety Observatory. (2016). "Traffic Safety Basic Facts 2016 – Gender." Available: https://ec.europa.eu/transport/road_safety/sites/roadsafety/files/pdf/statistics/dacota/bfs2016_gender.pdf [January 15, 2022]
- [9] IWA Country Classification. (2019). Available: <https://iwa-network.org/wp-content/uploads/2019/01/2019-Country-Classification-Update-2018-08-06.pdf> [January 20, 2022]
- [10] A. Powell, A. Bagilhole, A. Dainty and R. Neale, "Coping in construction: female students' perspectives", *Proceedings of the 21st Annual ARCOM Conference*, London, 2005, pp. 33-42.
- [11] "Overcoming gender stereotypes in the construction industry." *Breakwithanarchitect* (2019). Internet: <https://www.breakwithanarchitect.com/post/interview-overcoming-gender-stereotypes-in-the-construction-industry> [January 15, 2022]



Ljubiša Preradović, University of Banja Luka, ljubisa.preradovic@aggf.unibl.org
Sandra Kosić-Jeremić, University of Banja Luka, sandra.kosic-jeremic@aggf.unibl.org
Snježana Maksimović, University of Banja Luka, snjezana.maksimovic@aggf.unibl.org
Miroslav Malinović, University of Banja Luka, miroslav.malinovic@aggf.unibl.org
Đorđe Stojisavljević, University of Banja Luka, djordje.stojisavljevic@unibl.org

GENDER DIFFERENCES IN THE ACHIEVEMENTS OF CIVIL ENGINEERING STUDENTS

Abstract

The paper analyzes gender differences in the length of study and average grade between the number of enrolled and graduated students at the Faculty of Architecture, Civil Engineering and Geodesy in Banjaluka, during the period from 1996 to 2015. It was concluded that women, in civil engineering studies, are just as successful as men. However, it is noticeable that women in Bosnia and Herzegovina, enroll much less in engineering studies. Engineering studies need to be more popularized among women. The results of the analysis are presented using the SPSS statistical analysis software package

Keywords: gender differences, length of study, average grade

ПОЛНЕ РАЗЛИКЕ У ПОСТИГНУЋИМА СТУДЕНАТА ГРАЂЕВИНАРСТВА

Сажетак

У раду се анализирају полне разлике у дужини студија и просјечној оцјени између броја уписаних и дипломираних студената на Архитектонско-грађевинско-геодетском факултету у Бањалуци, у периоду од 1996. до 2015. године. Закључено је да су жене на студијама грађевинарства, једнако успјешне као и мушкарци. Међутим, уочљиво је да жене у Босни и Херцеговини много мање уписују инжењерске студије. Инжењерске студије требају бити више популаризоване међу женама. Резултати анализе представљени су помоћу статистичког софтверског пакета SPSS.

Кључне ријечи: полне разлике, дужина студија, просјечна оцјена

1. INTRODUCTION

In the recent years it has been observed the higher interest for enrollment at the technical departments at the universities in Bosnia and Herzegovina. A similar situation is also in the neighbouring countries, such as Serbia and Croatia. At some technical faculties in the neighbourhood potential students pass an entrance exam (for example Sarajevo, Belgrade, Zagreb), while at some, candidates don't take the entrance exam (for example Ljubljana).

In this paper, we were observed only the faculties of Civil engineering, in Banja Luka and neighbouring countries. At the Faculty of Civil Engineering in Sarajevo and at the Faculty of Architecture, Civil Engineering and Geodesy in Banja Luka (AGGF) a potential student can gain points based on secondary school GPA, secondary school grades received in specific subjects and the entrance test. Besides that, the Faculty additionally recognizes other achievements during the secondary education that are relevant to the field of potential studies [1], [2]. The Faculty of Civil Engineering at the University of Belgrade takes into account the secondary school GPA and the success gained at the Entrance Exam [3]. The secondary school GPA contributes with 40% to the maximum of gained points, while the entrance exams consisting of Mathematics only, adds 60%. The candidates that have been awarded with one of first three positions in national or international contests in mathematics are granted with waiver for the entrance exam. Faculty of Civil engineering at the University of Zagreb foresees the admission based on achievements in the secondary school GPA and State Secondary School Graduation Exam. Additional achievements like one of first three places on national contest in Mathematics or Physics can secure the direct admission to the potential candidates [4]. At the University of Ljubljana, undergraduate degree in civil engineering can be obtained at the Faculty of Civil and Geodetic Engineering. The admission procedure is not done at the University, but centrally through national admission facilitated by the Government (state high school exam). The common documents, pre-university educations certificates and Slovenian language proficiency proof are prerequisites, and applicants are required to take tests of ability, capacity and skills, which is designed for each field of study accordingly [5].

According to [6], [7] analyzing academic success is very important for higher education institutions from the aspect of strategic planning of enrollment policy, change and improvement of curriculum of study programs. The paper [8] shows the importance of the entrance exam for enrollment at the Faculty of Civil Engineering, as well as the connection between success in the entrance exam and success in taking mathematical subjects. Most of the candidates who enroll in AGGF University in Banja Luka are from construction schools and Gymnasium, and students from Gymnasium achieve the best results at the entrance exam [9].

The universities of the countries of the former Yugoslavia belonged to the so-called continental education system. In that system, education for the title of B.Sc. civil engineer lasted 5 years (10 semesters). However, due to the excessive duration of studies and thus its inefficiency, as well as the growing demand for highly educated engineers in all countries of the former Yugoslavia, the Bologna system of studies was introduced [10]. So, from 2006 in Bosnia and Herzegovina, as well as at the AGGF in Banja Luka, students begin to study according to the Bologna system of study, where civil engineering studies last 4 years (8 semesters).

Through the recent few decades there has been a trend in investigating the achievement of students in the higher education in relation to the gender. In [11] authors analyses the gender stereotypes and the perception about the assumed affinity between gender and areas and professions. This study confirms that there are still women-dominated professions, such as Nursing, Social Work and Education and men-dominated professions, such as Informatics, Mechanical and Civil Engineering (according to Eurostat, in 2015 in this area 74% students were men). In [12], [13] authors analyze differences between men and women in their experience of higher education.

The paper analyzes the number of enrolled and graduated students in relation to the gender at the AGGF during the period from 1996 to 2015, while students who transferred from other higher education institutions and who took less than half of the exams are not included in this study. The observed students studied according to the Law on the University (until an academic year 2006/07) where undergraduate studies lasted 5 years (10 semesters) and we call it **before the Bologna process**, and thereafter according to the Law of Higher Education, where studies lasted 4 years (8 semesters) and we call it **according to the Bologna process**. This paper aims to answer the following research questions (RQs):

RQ1: Are there gender differences between the number of enrolled and graduated students, all students together and separately according to the law under which they studied?

RQ2: Are there gender differences in the length of study, all students together and separately according to the law under which they studied?

2. SAMPLE AND ORGANIZATION OF RESEARCH

The Faculty of Architecture, Civil Engineering and Geodesy, University of Banja Luka consists of three study programs: Architecture, Civil Engineering and Geodesy. A sample of our study consists of 1314 Civil Engineering students (396 female and 918 male) of which 619 students graduated (207 female and 412 male). According to the Law of the University 687 students are enrolled (230 females and 457 males), and 353 students (124 females and 229 males) graduated. According to the Law of Higher Education 627 students were enrolled (166 females and 461 males), and 266 students graduated (83 females and 183 males).

For the statistical analysis we used the SPSS v.20 analytical-statistical software package, using descriptive statistics for presenting and summarizing data, χ^2 test, nonparametric Mann-Whitney U test, and Spearman's rank correlation coefficient [14], [15]. The variables observed in this study did not have normal distribution.

3. RESULTS AND DISCUSSION

According to the Law on the University, a total of 687 students were enrolled (230 females and 457 males), and 353 students graduated (124 females and 229 males). Using the χ^2 test, no statistically significant difference ($\chi^2 = 0.2823$, $p = 0.59522$) was obtained in the number of enrolled and graduated students by gender.

According to the Law on Higher Education, a total of 627 students (166 females and 461 males) were enrolled, and 266 students (83 females and 183 males) graduated. Using the χ^2 test, no statistically significant difference ($\chi^2 = 2.076$, $p = 0.14964$) was obtained in the number of enrolled and graduated students by gender.

According to the both laws, 1314 students were enrolled (396 females and 918 males), and 619 students graduated (207 females and 412 males). By applying the χ^2 test, no statistically significant difference ($\chi^2 = 2.1401$, $p = 0.1449$) was obtained in the number of enrolled and graduated students by gender.

In following three sections we analyze only the achievement of graduated students regarding to the Law of the University and the Higher Education law separately and both together.

3.1. THE ANALYSIS OF THE ACHIEVEMENTS OF STUDENTS WHO GRADUATED ACCORDING TO THE LAW OF THE UNIVERSITY

The average length of study was 2986.98 days (8.184 years). Female students have on average shorter studies (2972.67 days or 8.144 years) compared to male students (2994.73 days or 8.205 years). The shortest study (1635 days or 4.479 years) was achieved by one of the male students (Table 1).

Table 1. The length of studies before the Bologna process

Gender	N	Minimum	Maximum	Median	Mean	Std. Deviation
male	124	1748,0	8023,0	2747,000	2972,677	970,7478
female	229	1635,0	6262,0	2801,000	2994,729	783,5331
Total	353	1635,0	8023,0	2780,000	2986,983	852,6747

The Mann-Whitney U test showed that there was not a statistically significant difference ($z = -1.485$, $p = 0.138$, $r = 0.0779$) in the length of study in relation to the gender of students.

The average grade during studies was 7.5356 (among female students the average grade is slightly higher and amounts to 7.6651 compared to male students who had an average grade of 7.4654). The highest average grade (9.66) was achieved by students of both genders, and the lowest average grade (6.34) was achieved by one of the female students (Figure 1).

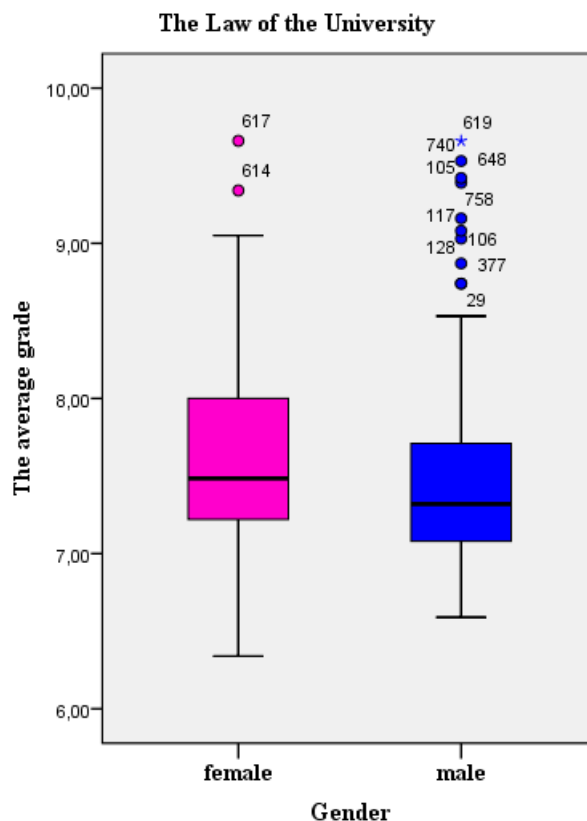

Figure 1. *The average grade in relation to the gender of students before the Bologna process*

Using the Mann-Whitney U test, a highly statistically significant difference ($z = -3.458$, $p = 0.001$, $r = 0.184$) was obtained with the average grades in relation to the gender of students.

3.2. THE ANALYSIS OF GRADATED STUDENTS ACHIEVEMENT FOR ALL STUDENTS TOGETHER, ACCORDING TO THE BOTH LAW

Using the Mann-Whitney U test, a highly statistically significant difference ($z = -3.302$, $p = 0.001$, $r = 0.1365$) was obtained with the average grade in relation to the gender of the students, regardless of the law according which they studied (female students had an average rank of 345, and male students had an average rank of 294).

Both, female ($z = -2.826$, $p = 0.005$, $r = 0.1959$) and male students ($z = -5.581$, $p = 0.000$, $r = 0.2746$) had a highly statistically significantly higher average grade when studying according to the Bologna process. The average grades of students according to the both laws are presented in Figure 2.

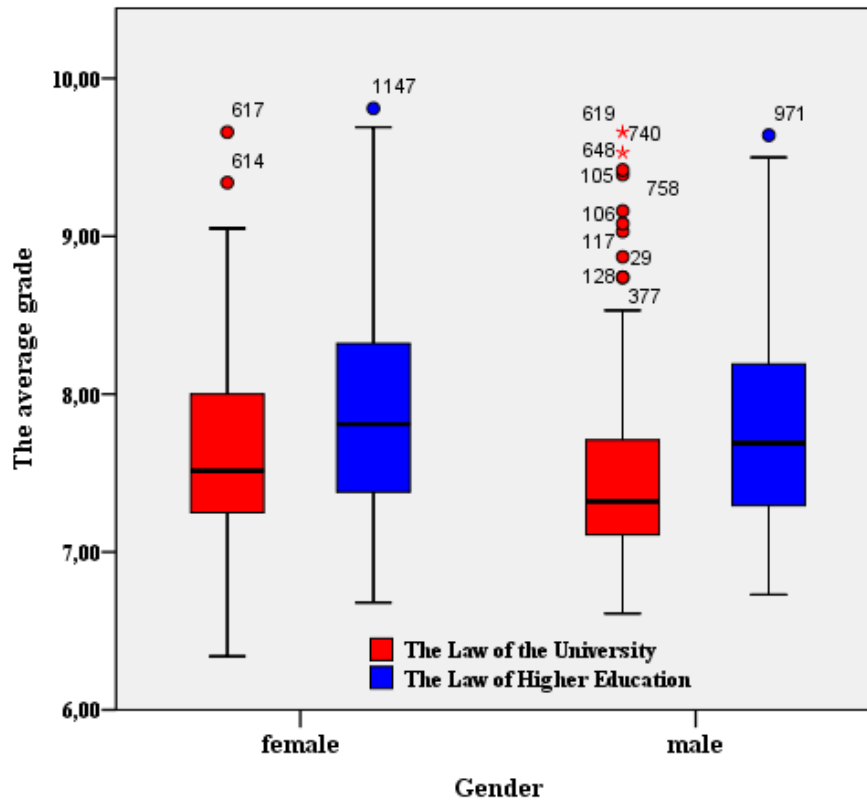

Figure 2. The average grades of students before the Bologna and according to the Bologna process

The average grades of student according to the both lows, years of enrollment and gender of students are shown in Figure 3.

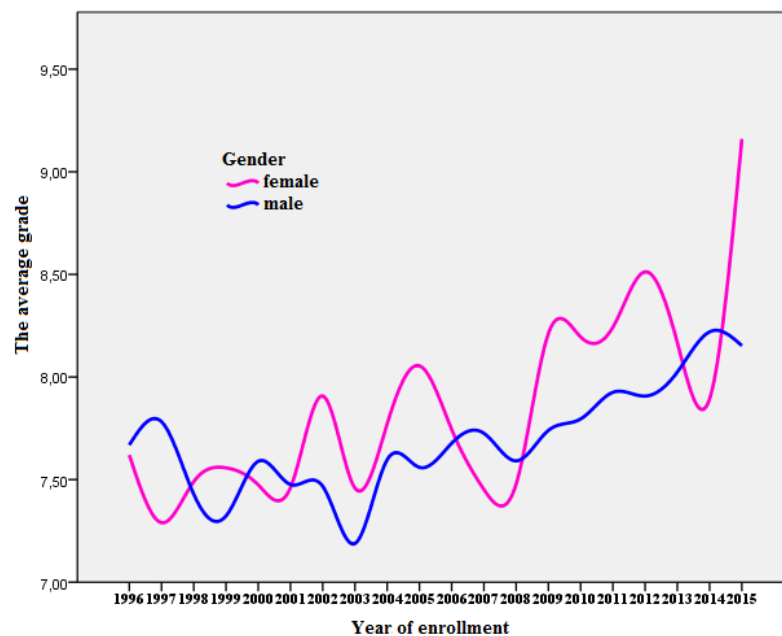

Figure 3. The average grades of student according to the both lows, years of enrollment and gender

4. CONCLUSION

Based on the obtained results, it was concluded that there is no statistically significant difference between the number of enrolled and graduated students by gender, according to the both Laws under they studied. It is significant to note that under both laws, female students were less likely to enroll in civil engineering studies (the ratio of men and women is about 2.5:1). About, half of the number of all enrolled students graduated, for both gender, and according to the both laws.

According to the both laws (before the Bologna process and according the Bologna process) there was not a statistically significant difference in the length of study in relation to the gender of students.

A highly statistically significant difference was obtained with the average grades in relation to the gender of students, for students who graduated according to the Law of the University. Among female students the average grade is slightly higher and amounts to 7.67 compared to male students who had an average grade of 7.47. According to the Law of Higher Education there was not a statistically significant difference of the average grade in relation to the gender of students. But, we can noticed that this students have higher average grades than students who graduated according to the Law of the University. The average grade during studies was 7.82 (among female students the average grade is slightly higher and amounts to 7.94 compared to students who had an average grade of 7.77). Both, female and male students had a highly statistically significantly higher average grade when studying according to the Bologna process.

From all the above and the results obtained, we can conclude that women, in civil engineering studies, are just as successful as men. The Bologna process yielded slightly better average grades during the studies. However, it is noticeable that women in Bosnia and Herzegovina, as well as in other neighboring countries, enroll much less in engineering studies [12], [13], [16]. The reason for that is the possible length of the study, as well as the fact that women still consider that is the job of a civil engineer just for men. Engineering studies need to be more popularized among women and prejudices broken down.

ACKNOWLEDGMENT

This paper was supported by the "Localization in the phase space: theoretical, practical and numerical aspects", No. 19.032/961-103/19 funded by MNRVOID Republic of Srpska.

LITERATURE

- [1] Univerzitet u Banjoj Luci, Arhitektonsko-građevinsko-geodetski fakultet, <https://aggf.unibl.org/sr/vesti/2020/03/informator-2020> [22.02.2022.]
- [2] Građevinski fakultet Univerziteta u Sarajevu, <http://www.gf.unsa.ba/?lokacija=nastava>, [17.09.2020.]
- [3] Sveučilište u Zagrebu, Građevinski fakultet, <https://www.grad.unizg.hr/images/50011677/odluka%20o%20kriterijima%20za%20upis%20u%20prvu%20godinu%20prediplomskog%20sveuciliskog%20studija%20gradjevinarstva%20u%20ak%20god%202021-2022.pdf>, [27.11.2020]
- [4] Građevinski fakultet Univerziteta u Beogradu, <https://www.grf.bg.ac.rs/home> [27.11.2020.]
- [5] Univerza v Ljubljani, <https://www.uni-lj.si/study/bachelor/> [27.11.2020].
- [6] V. Simeunović, LJ. Preradović, "Using data mining to predict success in studying", *Croatian Journal of Education*, 16(2), pp. 491-523, 2014.
- [7] LJ. Preradović, Đ. Stojisavljević, A. Gaćina, "Primjena informacionih tehnologija u analizi i predviđanju uspjeha studenata", *AGG+ časopis za arhitekturu, građevinarstvo, geodeziju i srodne naučne oblasti*, br.6, pp. 28-38, 2018. doi: 10.7251/AGGPLUS1806028V
- [8] LJ. Preradović, S. Kosić-Jeremić, "Povezanost uspjeha studenata geodezije tokom studija sa kvalifikacionim ispitom I završenom srednjom školom", *XLVI Simpozijum o operacionim istraživanjima SYM-OP-IS*, Kladovo, pp. 586-591, 2019.
- [9] LJ. Preradović, S. Kosić-Jeremić, "Student achievement in the university entrance examination and the effects of preparation classes", *Technical gazette*, vol.22, No.3, pp.785-791, 2015. doi: 10.17559/TV-20140513114019
- [10] A. Szavits-Nossan, "Bolonjska deklaracija i novi studij građevinarstva", *Građevinar*, 58, pp.357-366, 2006.

- [11] C. Mesquita, P.L. Lopes, "Gender Differences in Higher Education Degree Choice", *10th International Conference on Education and New Learning Technologies*, pp. 9794-9801, Palma Malorca, Spain, 2018. doi: [10.21125/edulearn.2018.2358](https://doi.org/10.21125/edulearn.2018.2358)
- [12] R. King, "Gender Differences in Experience of Higher Education: quantitative and qualitative Approaches", *Educational Psychology: An International Journal of Experimental Educational Psychology*, Taylor & Francis Online, vol.11, Issue 3-4, pp. 363-382, 2010. doi: 10.1080/0144341910110311
- [13] D. Starovoytova Madara, S.Sitati Namango, "Longitudinal Comparative Study: Females' vs. Males' Graduation Outcomes in Undergraduate Engineering", *Journal of education and Practise*, Vol.7, No. 30, 2016
- [14] LJ. Preradović, V. Đajić, *Analitičko-statističke tehnike u savremenim istraživanjima*, Arhitektonsko-građevinski fakultet Univerziteta u Banjoj Luci, 2011.
- [15] S. Jakšić, S. Maksimović, *Verovatnoća i statistika, teorijske osnove i rešeni primeri*, Univerzitet u Banjoj Luci, Arhitektonsko-građevinsko-geodetski fakultet, 2020.
- [16] Institut za društvena istraživanja u Zagrebu: Tko studira i zašto?, Izvještaj o rezultatima projekta Socijalni identiteti, pristup visokom obrazovanju i odabir studija, <https://www.idi.hr/sipvoos/IZVJESTAJ-za-web-finalno.pdf>, [03.04.2021.]



Marija Mihajlović, Ministry of construction transport and infrastructure,
mmihajlovic1251997@gmail.com

Ljiljana Stošić Mihajlović, Academy of Technical and Educational Studies in Niš,
stosicmihajlovicljljana@gmail.com

EDUCATION OF ARCHITECTURAL ENGINEERS IN SERBIA FOR THE SUSTAINABLE DEVELOPMENT MODEL

Abstract

Understanding the developmental needs of society, engineers have always enabled the development of civilization. Due to the challenges they faced and the tasks that await engineers in the future, there is a need for their new knowledge and skills, necessary to solve problems related to the paradigm of sustainable development. This paper analyzes the requirements of the sustainable development model and the role of architectural engineers in creating solutions within this model. The basic potential for sustainable development consists of educated and professional people in general, education and training of architectural engineers for efficient performance, in modern conditions imposed by globalization with strong competition in the open world market and knowledge society.

Keywords: education, sustainable development, globalization, architectural engineers.

ОБРАЗОВАЊЕ ИНЖЕЊЕРА АРХИТЕКТУРЕ У СРБИЈИ ЗА МОДЕЛ ОДРЖВОГ РАЗВОЈА

Сажетак

Разумевајући развојне потребе друштва инжењери су одувек омогућавали развој цивилизације. Због изазова са којима су се суочавали и задатака који инжењере чекају у будућности, јавља се и потреба за њиховим новим знањима и вештинама, неопходним за решавање проблема везаних за парадигму одрживог развоја. У овом раду су анализирани захтеви модела одрживог развоја и улоге инжењера архитектуре у креирању решења у оквиру овог модела. Основни потенцијал за одрживи развој чине образовани и стручни људи уопште, посебно је анализирано школовање и усавршавање инжењера архитектуре за ефикасно обављање улоге, у савременим условима које намеће глобализација уз јаку конкуренцију на отвореном светском тржишту и друштву знања.

Кључне ријечи: образовање, одрживи развој, глобализација, инжењери архитектуре.

1. INTRODUCTION

Modern technological development has conditioned the need to change the traditional use of certain natural resources, including material resources (mineral, physical, biotic) and natural conditions (water, climate, atmosphere). An accelerated transition is now underway from the classic socio-economic model, based on the maximum exploitation of natural resources according to the norms of outdated industrial development, to a new technological, economic and social model of sustainable development, dominated by knowledge and all new technologies.

The concept of sustainable development includes technological, economic, cultural, sociological and environmental components, but is based on technical disciplines - specifically engineering. Since engineering is the main actor and support of modern development, it has obligations to develop and introduce appropriate technologies in a creative relationship with other elements of the social system. Business methodology within the concept of sustainable development implies detailed knowledge of each technological change as a development process, and especially the dynamics of diffusion of new technologies, as well as the consequences of this process on economic activity and social development.

Since the beginning of the development of human civilization, engineers have shaped the world in which man lives [1]. Since the time of Aristotle, cognition and study of complex phenomena has been done analytically, by breaking down the whole into components, and their synthesis in the field of technical and technological development primarily belongs to the engineer as a designer, researcher or user of technology.

Of course, technical and technological development includes other disciplines, which obliges the engineer to know other areas, so much so that he could design and implement a correct and rational approach in that synthesis. In this sense, the aim of the paper is to identify the current and future role of architectural engineers in the implementation of the concept of sustainable development, taking into account the global character and specifics of that development. Due to the connection of technological development with global economic and social trends, attention is paid to new trends in education, from the point of view of current and future structure of the world economy and use of resources for development, from the point of view of education and professional training of architectural engineers, but so that it is in the function of improving the quality of life of present and future generations. In the text focuses of the Faculty of Architecture in Belgrade explain the AF BG has been such as because it is the oldest, biggest and the most significant and influential school in the country, and the base for all other national schools

2. TECHNICAL-TECHNOLOGICAL DEVELOPMENT AND THE PROCESS OF GLOBALIZATION

2.1. MODERN MODEL OF ECONOMIC AND TECHNOLOGICAL DEVELOPMENT

Until a few decades ago, natural resources in the economic sense were considered key elements of economic development, and most countries pursued their own development policy with the maximum use of all natural potentials. This policy did not stand the test of time, and the emergence of the development crisis during the 1970s meant the beginning of the process of redefining the model of economic development and changing the overall structure and dynamics of relations within the global system [2]. Today, changes in development policy are underway with the implementation of globalization and the creation of an open market, with accompanying crises, disruptions and economic recessions, which can be seen as a result of great mismatch between the dynamics of technological development and social environment. The mismatch between the mutual influences of man and nature led to the exhaustion of the development potentials of the old model, in which thick smoke from factories and large parts of occupied and endangered areas became a measure of economic power and success of industrial society. It is a well-known fact that such growth of the world economy has had negative consequences in terms of environmental degradation and degradation, as about 24 million hectares of fertile land (Australia-sized area) and about 17 million hectares of forest (Austria-sized area) have disappeared each year. cutting and turning into arable land, and due to drying caused by air pollution and acid rain.

Today, it is clear to everyone that such a development policy, based on excessive exploitation of natural resources and environmental pollution, does not satisfy the equal basic rights and living needs of present and future generations. Such a model of economic and social development did not adequately treat the need to maintain the balance of relations between man and nature, nor were the effects of such development adequately determined, because the costs of depletion of non-renewable

resources and degradation of the natural environment were deliberately neglected. successful accumulation of capital and growth of national income. Because, production in which resources, space and environment are treated as non-economic development factors, ie as a public good available to everyone and without paid price, has as a final result a drastic reduction of natural wealth.

The adoption of the concept of sustainable development was made at a time of great and sudden changes in the world in the form of crises and a number of existential problems of modern civilization (political, social, economic, environmental). The new concept is focused on integrated economic, technological, social and cultural development, harmonized with needs

conservation of resources and protection of the environment. But, instead of solving the problem of dirty technologies in developed countries, their transfer and continued production in underdeveloped countries (which does not achieve positive change at the global level), the new techno-economic policy included the formation of markets with specific requirements and development of new technologies. which in their functional structure respect the principles of sustainable development.

The transition to a new model of development cannot be done without problems in the transformation of existing production potentials, because it implies a change in the prevailing patterns of social behavior and outdated institutional infrastructure, which in the new situation are no longer sufficiently efficient.

As the concept of sustainable development implies that man uses nature to meet the needs of present generations without compromising the ability of future generations to meet the needs of their own natural resources, sustainable use of natural resources only as far as their reproduction allows, implies harmonization of economic development environments, ie the limited use of non-renewable natural resources and the growing orientation towards the use of renewable resources. The concept of sustainable development has been declared the basis of world development policy by the UN, and the Program of Activities for the 21st Century ("Agenda 21"), a UN document adopted in Rio in 1992, is based on it [4]. The concept of sustainable development introduces the principle of internalization of external costs, which implies that activities that have been developed (and successfully operated) in the former economic, social and civilizational environment, can cause greater damage to the natural environment than economic benefits. This concept also calls into question the application of the previously introduced principle that "the polluter pays", ie. to bear the external costs of environmental damage, as this also leads to a deterioration in their economic performance.

Radical advocates of environmental protection believe that within the new techno-economic model, all economic branches that inadequately treat the relationship between man and nature should be abandoned, and even the models of export economy that result in the depletion of natural resources should be abandoned.

In many countries, science and technology have long been used as a means of rapid social growth, because investors as carriers of this development were motivated to improve the performance of technologies, products and services, and technological innovation. Today, in accordance with the understanding that the positive impact of new technologies on changing the factors of the productive process is comprehensive, and thus affect the increase in quality in some parts of the reproductive process, the absolute advantage belongs to new technologies.

2.2. CHALLENGES OF GLOBALIZATION

The change in socio-economic development was introduced by the process of globalization, which is reflected in the creation of a unique economic, political and cultural environment, in which people, ideas, goods and capital circulate freely, so that the world becomes mutually integrated. Everything that is happening at the local level can be reflected globally, which has enabled the advancement of technology, at the heart of which are new information and communication technologies, and the transfer of technology and knowledge has become a key element in achieving international competitive advantage.

Globalization as a process has been going on for centuries - since the appearance of the first caravans and overseas sailing ships, and it has accelerated the construction of railways and highways, the use of container ships and the emergence of air traffic, to its full expansion. Therefore, it is believed that globalization has emerged as a result of great technological progress, and its center is the rapid flow of information and information and communication technologies.

As the process of globalization introduces as a necessity the opening of national markets to global competition, every company (as well as the national economy as a whole) must ensure global competitiveness in order to survive and thrive. Globalization is also changing the way companies

do business. For example, today all 132,500 components for the new Boeing 787 are produced in 545 locations around the world [5].

In the business world, human resources and their knowledge are becoming the main value of companies and are recognized as a real source of competitive advantage [6]. The emergence of an open world market is accompanied by the need for a more skilled workforce, the acquisition of new knowledge becomes imperative, because the competitiveness of a company increasingly depends on the structure and qualification of the workforce and its ability to accept new knowledge and technologies [7]. Modern companies are constantly exposed to pressures to increase labor productivity, which directly depends on the quality and educational level of the workforce, and are directed to a market where there is a growing demand for educated professionals [8].

Thanks to globalization and the development of technology, knowledge and innovation are becoming the key to global competition, and the mobility of professionals has increased due to the growing need for a more skilled workforce. Competition and deregulation also lead to the necessary restructuring of companies, and even entire industries, with inevitable changes in the shaping of the work process and the workplace itself. Today, the working environment is changing at a tremendous rate, so that the former division of workers according to white and blue collars is being lost. The application of computers and technological improvements has changed the very nature of work, as well as specific requirements and other conditions for its performance. With the development of information and communication technology, the globalization of business is increasingly putting the intellectual capital of the company [9].

Accelerated changes in the environment and convergence of knowledge in many areas will make the profile of engineers move out of strictly technical templates. In order for engineers to take the lead in creating responses to global and local, technological, economic, social and other challenges of globalization, it is necessary to understand and respect nature, ethics, economy, society and culture, to be able to quickly identify in a changing environment needs to create and implement long-term sustainable and efficient technological solutions [10].

3. ECONOMY, SCOPE AND OBSOLETE OF KNOWLEDGE

Due to the increasingly competitive environment created by globalization, as a result of the imbalance between supply and demand for staff in key areas, there is a lack of appropriate experts. While on the demand side are the challenges posed by global economic growth, as well as the rapid growth of the technology and telecommunications sectors, on the supply side are mostly older generations of professionals, whose exit from the technological process is not balanced by younger professionals entering the same market [11]. While on the one hand the demand for staff has increased, on the other hand the lack of appropriate experts is intensifying the struggle for staff [12]. Globalization is unstoppable, in the future an even fiercer struggle for staff is expected, in which companies must constantly look for new and creative approaches to the development, motivation and retention of their staff. In response to this personnel crisis, Western economies are trying to attract experts through the so-called "Brain exchange" or "brain circulation". Such movement of experts is two-way, but usually not permanent. The governments of many countries are therefore trying to help their companies find staff by investing large amounts of money and time in programs to attract and retain domestic staff, but also to intensively attract experts from foreign countries. Thus, for example, the United States uses the so-called "Green card".

The knowledge economy is mainly based on specialized knowledge and the skill of connecting, identifying and solving problems. As a rule, new areas of development and investment cause disruptions of the institutional environment and cross-confrontations, which slows down the diffusion of new technologies. On the other hand, new technologies enable the greatest productivity growth in those industries or activities that are most easily transformed and adapted, and which were less attractive for earlier mass production technologies used by engineers in the previous development model.

At the same time, the volume of newly created knowledge in the world is increasing at a tremendous rate. Experts expect that in the next ten years, as much knowledge will be "produced" as in the previous 2000 years. This will necessarily lead to the most intensive technology transfer and dissemination of knowledge in history, as well as to the establishment of new global measures of value, as the boundaries of all kinds will gradually disappear.

As a result of this process, although more and more widely available, knowledge will become obsolete faster. Research has shown that the level of obsolescence of knowledge has accelerated 10 times in the last 100 years [6]. This means that if at the beginning of the twentieth century it took 40

years for the level of knowledge to fall by 50%, at the end of the first decade of the 21st century it happens in just 4 years.

4. EDUCATION AND PROFESSIONAL TRAINING OF ARCHITECTURAL ENGINEERS

4.1. ENGINEER TRAINING

The rapid development of new technologies, as well as their competitive struggle on the world market, have led to great competition from the leading countries in the field of technological development, ie science and school education. The education of engineers gained a major role in the development of new technologies and the development of modern means of production, as well as in the formation of methods of managing technological processes, which depends on the quality and cost of production and competitiveness of the economy in the world market [13]. As there are frequent situations in such a market that companies have to change production, even the type of activity, an engineer must be able to adapt to new conditions, and his education becomes the integration of technical education with natural science, humanitarian and socio-economic education. Based on the observed trends, it is clear that engineers expect a number of challenges, such as: forming the physical infrastructure of fast-growing urban areas, optimizing clean energy sources, providing drinking water, expanding information and communication infrastructure, adapting technologies to aging populations, environment, management of complex projects and interdisciplinary problems, all with increasing customer demand in terms of quality, design, flexibility and personalization of products. At the same time, attention must be paid to correcting and neutralizing the consequences of the hitherto inadequately implemented model of world socio-economic development [14]. Such a set of tasks awaits the future engineer.

The traditional study of technology consisted of introducing students to fundamental knowledge that would enable them for real life. It was important for the faculties that the students get a solid base, and the historical faculties were not particularly interested in what they would do in the future. Such schooling was placed somewhere between preparing graduates for further academic careers or for work in the economy, where they will learn how engineering work is really done. Practically, graduates are ready to pursue careers in one of four general directions:

- academic (researchers; research and teaching associates; future university professors),
- professional (engineers, project managers, company managers),
- commercial (sales support, product management, marketing, sales) and
- entrepreneurial (running your own business or participating in a team that includes both business and technical part of the company's business).

Higher education is now at a serious turning point. Education will need to offer a new set of knowledge, skills and competencies that will enable engineers to cope with a rapidly changing environment and to help society adapt to change. Namely, the speed of technological development has greatly exceeded the objective needs of society and, in order for society to get the most out of existing technology, it must learn how to adapt that technology to its needs while remaining in harmony with nature. It is understood that the education of engineers should be shaped by the requirements of the global market and the rules of global business conduct, where the concept of knowledge-based economy is increasingly prevalent.

The countries of the Western Balkans, including Serbia, are mainly looking for ways and mechanisms to transform their economies, speed up integration into sustainable development and expand access to clean and safe technologies. Without questioning the quality of education that engineers receive in the Western Balkans (this quality has so far been verified by their easy and fast employment in foreign companies and their success in the world), they most often fall into the category of better paid technical staff. As such, they perform the technical tasks entrusted to them in the economy or in development, doing the creative part of the job, defining the characteristics of products, selling them, analyzing the market and competition, and according to their success, they are more rewarded.

As the concept of sustainable development is most often aimed at the rational use of natural resources while preserving natural ecosystems and raising the quality of the environment, it can be considered that this concept is a special challenge for engineers, who in these activities contribute to long-term sustainable development. In order for the countries of the Western Balkans to be ready to offer something new to the global market, they must change the education system so that future engineers can be more competitive in the domestic and world labor market and able to respond to paradigm shifts. Graduates of engineering must be ready to manage a team (when, due

to good engineering knowledge and achieved results, they are entrusted to be project managers), to know very well what the market requires and how to turn their business idea into a business plan, which will and be financially sustainable. At the same time, they should know the behavior of the customer and his future needs, which contributes to the harmonization of their creative innovative ideas and with reality, measured by business success.

The time of globalization poses a huge challenge for technical faculties to improve the situation in which curricula are very unevenly harmonized with the Bologna Declaration, new faculties are opened, competition between private and state, domestic and foreign faculties is stronger, global trends in science and education are changing rapidly, industry and employment, and the economy is becoming more knowledge-based. The enumerated trends and observed potential problems that engineers will face indicate the need for new skills and abilities that need to be developed in them [15]. This means that the education of engineers will continue to be firmly based on technical sciences, physics and mathematics, but also that it must be expanded by connecting with the social sciences, economics, art, design and other fields. At the operational level, priorities in the education of engineers are preparation for practical work on real-life examples and through a complete cycle model, from problem identification to monitoring the function of the implemented solution. Therefore, it is of special importance that professors also have experience from practice, ie. that they worked for or in the economy and solved practical problems.

In connection with the acceleration of the process of creating and obsolete knowledge, he also raises the question of the need to introduce new diplomas in order to be clearly recognized, formally verified and more precisely determined level of qualification necessary for the knowledge-based economy.

For example, from the beginning of the 20th century until today, the number of doctors of science and the age in which a doctorate is obtained as the highest formal qualification have changed drastically. At the beginning of the last century, when graduate engineers were rare, the doctorate was acquired exceptionally. In the middle of the 20th century, the doctorate was perceived as the crown of a career and was acquired in advanced working life (with 45 years of life in Europe, 35 in the USA), while today it has become normal for students to obtain a doctorate in engineering without previous work. experiences (with 27-30 years of age) [5]. This change imposes the need to recognize new degrees of qualification of engineers, with the introduction of lifelong learning.

4.2. PROFESSIONAL TRAINING AND DEVELOPMENT OF ENGINEER'S CREATIVITY

In today's knowledge-based economy, the contribution of knowledge-based professionals is of strategic importance. Therefore, the acquisition of new knowledge and skills through professional development of employees, which leads to new products and increased productivity, has become necessary to achieve competitive advantage, and plays an important role in market positioning and human resource development. It is evident that the multidimensionality of the modern world, and thus the problems that an engineer encounters, requires him to constantly acquire new knowledge and skills. This means that he must constantly supplement his knowledge and abilities, which practically means that he must be committed to continuous professional development through the so-called. lifelong learning.

So far, it has been characterized by frequent misuse of engineers' knowledge in order to make as much profit as possible in the shortest possible time, with the usual ignoring of the consequences of such behavior. The global application of this model has already led to instability and crises around the world, and in the ethical sense it is necessary to make evolutionary corrections of engineers' actions in order to bring their activities to balance the needs of technological development and ethics [15]. This would help overcome turbulence in the process of globalization and in the transition to a new era of post-globalization. Essentially, this implies an additional challenge for the continuous ethical training of engineers.

A common factor for all countries is to focus on the market and to constantly find new products and services that will respond to still unmet or future market needs. At the same time, competitive advantage in the globalized market is achieved not only thanks to scientists and educated engineers, but the greatest profit growth is achieved through creativity and innovation, and the area that shows the greatest growth is the application of creative solutions and innovations in old technologies [16]. In the field of high-tech economy, a particularly great turn towards creativity is being implemented, where creativity is becoming a key competence of engineers in the future knowledge society. Such an economy reduces jobs in the manufacturing sector by shifting low-paid activities to underdeveloped countries, where wages are low and work ethic is high (as is the case in Japan, India, China). Strategic changes are made by constantly improving business, reorganizing, changing

activities or closing unprofitable companies, which has become a special challenge for managers, but also for engineers, who, in addition to professional knowledge and skills, require the ability to creatively use non-traditional methods in solving problems.

Historically, human creativity has enabled the development of society, the acquisition of new knowledge, the creation of cultures and other foundations important for the general progress of civilization. However, innate creativity has a relatively low probability of appearing, so it is necessary to develop it. Creativity requires a lot of knowledge, preferably from several different fields, because in order for knowledge to be connected into new wholes, it must be enough about each area in which a person wants to be creative. Artificial intelligence has been significantly improved (supercomputers are already beating people in chess and other games dominated by combinatorics and analytics), but its ability to creatively solve problems is still very far away. Therefore, with the knowledge and experience, the creativity of experts will remain highly valued. Today, the labor market is globalized, and the globalization of the world economy is intensifying the search for creative talented engineers. As technology opens up new frontiers of information and access to new knowledge, it also creates the opportunity to hire an increasingly educated and skilled workforce from the market. Because of a better job, talented engineers easily change countries and companies, so migrants are often more qualified than domestic staff. However, migrants can improve the quality of products in the short term, but not in the long run, because in the meantime, domestic staff will learn new techniques and practices that foreign labor has brought from their country. Due to the growing internationalization of information, ideas, goods and capital, as well as the talent crisis, the demand for talent is expected to intensify in the next twenty years, because the departure of talented professionals usually harms the company, it must adapt to the situation for creative talents.

Contrary to the growing need for creative staff, business circles are faced with less and less opportunities to find experts who will effectively lead companies and successfully confront business and technological challenges. The system of student education at the faculties, as a rule, forms a reproductive engineer,

trained mainly for routine work, so that the creative character of design and research and development work requires additional professional training in order to acquire skills and abilities to be able to see certain problems from another perspective. This is especially because he is an engineer as a rule and in the role of coordinator of development ventures, and must not only know his (technical) profession well, but also know enough other professions covered by a specific multidisciplinary project to be able to perform a creative synthesis of results of all professions and give an integral assessment application of certain technological solutions.

It is here that significant disruptions arise from the system of general education, where creativity is almost neglected [17]. This leads to the need to reform general and special vocational education so that the complete education system becomes dynamic and constantly improves, creating, in addition to training students to perform certain tasks creatively, the possibility of their further continuous training [18]. This is a new challenge for the higher education system, which needs to constantly adapt to the growing demands of the world market for educated and creative engineers while creating opportunities for their continuing professional development while working, as well as acquiring new qualifications within the higher education system. new and loss, ie reduction of the possibility of using the remaining previously acquired knowledge.

5. HISTORICAL OVERVIEW OF ARCHITECT'S EDUCATION IN SERBIA (19TH-21ST CENTURY)

Research on the overall development of the educational process of architectural engineers in Serbia shows that throughout history, it has been constantly changing and reforming.

The beginning of the education of architectural engineers in Serbia took place first at the Lyceum, which was moved from Kragujevac to Belgrade in 1841, when the first reform was carried out. Then the teaching of Civic Architecture was introduced. The official beginning of architectural education in Serbia is considered to be 1846, when the first Engineering School was established in Belgrade, outside the Lyceum, which lasted for three years.

If we look at the development of teaching at the Department of Architecture of the Technical Faculty, from the founding of the University to the First World War, we can see that developed and deepened various disciplines of architecture, from designing different types of public and private buildings, through knowledge of European architecture and historical styles. own medieval heritage, to the knowledge of construction technology, modern building materials and structures. Thanks to well-educated teachers, in European schools, and in practice, during the design and construction of

important public and private buildings, there was a permanent rise in teaching levels, so that the level of education of young professionals has largely reached European standards. In order to better monitor the development of the profession, technical and technical and stylistic changes in European architecture, the Department of Architecture has constantly developed and supplemented curricula, so that graduates were much more willing to work in practice, which is why their additional education was no longer necessary. in foreign schools [19]. After the First World War, there were some changes, which were more reflected in the individual authorial contributions of individual teachers and assistants than in the general curriculum. Between the two world wars, there is a strong influence of Russian emigrant architects, who mostly used belated classical academic design when designing monumental public buildings, while smaller buildings were characterized by so-called civic architecture. On the other hand, modern curricula, plans and architectural design influenced the formation of mostly domestic architects gathered around the Group of Modern Architects (GAMP) and their supporters. Before the Second World War, the earlier practice of graduate architectural engineers from the Department of Architecture going abroad to study or to supplement their studies with a shorter or longer stay in schools abroad was discontinued. It was a great success of the Belgrade Department of Architecture, which managed to raise teaching to the European level. After the Second World War, the more pronounced artistic character of education is noticeable, based on the architectural authority of individual professors through so-called classes and studios. This was, among other things, achieved by the freedom left to professors in the formation of methodological units within the subject, which lasts to this day. The general impression is that the Faculty of Architecture applied several educational methods ranging from polytechnics to the application of Bauhaus elements. The intensive period of changes in curricula began after the Second World War, when subjects with contents were introduced, which were compiled according to the requirements of the new social and state system with an emphasized social note.

Of all the reforms throughout history, certainly the most significant and influential was the one called the New School, adopted in 1971 under the leadership of Professor Bogdan Bogdanovic [20]. It is the only example of implemented experimental and radical reform in the education of architects in Yugoslavia after the Second World War. The new school implied a comprehensive change of the curriculum as well as a methodological approach in the implementation of teaching. New pedagogical models have been applied in it, radically changed in relation to the previous architectural school system. This reform process at the Faculty of Architecture in Belgrade was part of a broader movement at the world's most eminent architectural schools, as evidenced by the connection between the New School curriculum and teaching methods, and the most famous architectural faculties in the world. The teaching methods at the New School were a combination of approaches present in Columbia, Berkeley and the School of Architecture (AA) School of Architecture in London.

Since 1976, the reform processes at the Faculty of Architecture have continued to take place in a much more conservative way. The implementation of the Bologna reform at the very beginning seemed to be a renewal of the turbulent period of the introduction of the New School, but very quickly the whole team accepted the proposed reform because it was related to international TEMPUS (Trans / European Mobility Program for University Studies) project and national decision to join European integration.

The basic principles of the New School have remained relevant to this day and can be clearly seen to the greatest extent, although sometimes expressed in different terminology, in the Bologna reform curriculum. Numerous attitudes, defined in the New School program, such as multidisciplinary consideration of the design problem, research, discussions, scoring, etc., are present today in the curriculum formed in 2005 by the acceptance of the Bologna Process. Therefore, the New School in certain segments can be considered a precursor to the Bologna Process. The reason for this is that the basic principles of the New School were, in fact, taken from the international experience that this form of learning architecture cyclically reactivated, always in periods of turbulent socio-political events.

The teaching method is a studio in which teachers direct students to the sources of necessary knowledge, which leads them to theoretical courses that emphasize the importance of connection with projects. With these methods, students are trained to independently reach adequate sources and solve creative problems. The studio is designed so that in addition to the subject professor, professors or associates from practice from various disciplines related to the topic are included in the issue.

An interdisciplinary approach to the design problem is a common feature of the New School and the Faculty of Architecture reformed after the Bologna School. Interdisciplinarity in the New School envisages the elaboration of a project from various aspects of the living environment and the use of

engineering methods in which all architectural disciplines participate (design, urbanism, constructions, graphic presentation).

In the New School, teamwork and directing students to different disciplines are emphasized. In the Bologna reform, teaching in the form of design studies focused on students' independent work, unlike the New School, where design topics were covered in boxes, in permanent student jobs, where teamwork was imperative. Topics that are then were current in the New School are equivalent to today's modules in Architectural Faculty in Belgrade. They have different content, but the basic principles are the same. The student scoring system instead of grading was also a novelty in the 2006 program, and the same evaluation method was present during the New School, almost thirty-five years earlier. Orientation of students on topics that they would deal with in practice is present in both systems. Today, as in the period of the creation of the New School, the Faculty of Architecture is respected and integrated with school systems that function in the European Union and in the world.

6. RETHINKING ARCHITECTURAL EDUCATION AND THINKING ABOUT ITS FURTHER DEVELOPMENT AND PERSPECTIVES

In the European area, there are several different directions in the context of the proposed direction in which the architectural school should move. Most architectural schools follow the recommendations of the European Directive in which architecture, together with medicine, is recognized as a regulated profession. Namely, the directive contains eleven points that describe the knowledge that an architect should have at the end of his studies. On the other hand, there are architectural schools that are "beyond everything" and are guided by local and global trends in the profession and conducting certain experiments that can be of great importance for monitoring changes in the development of the architectural profession.

In order to determine the direction in which architectural education should be developed, it is necessary to analyze modern school programs that have carried out reforms according to the instructions of the European Commission and possibly the recommendations of American institutions. In the analysis, the need for the regional character and uniqueness of each architectural school must be taken into account.

During the contemporary discussions on architectural education, the situation from the end of the 1960s is again relevant, which requires a more responsible approach to the environment from architecture. Today, the education of architects often follows models developed in the past. As a result, many schools are not ready to tackle the modern needs of the living environment. Some authors who deal with architectural education, realizing the irresponsible attitude towards the environment, once again look back at the importance of experimental schools from the late 1960s and early 1970s. The call for new reform in education accordingly implies the introduction of green themes in the curriculum [21].

Starting from the thesis that sustainable development should become the backbone of architectural education, it is proposed to introduce basic courses on ecology in the curriculum, in addition to basic already existing study subjects, which would lead to a deeper study of ecology and settlement history and further to provide the necessary minimum content for understanding all forms of environmental design.

Future architects, urban planners, planners and landscape architects should jointly attend a basic design course with elements of sustainable development. Without overlapping the three disciplines of environmental design - architecture, urbanism and landscape architecture, one cannot speak of sustainable architecture [22].

During the contemporary discussions on architectural education, the situation from the end of the 1960s is again relevant, which requires a more responsible approach to the environment from architecture. Students should find a connection between climate and different cultural adaptations, such as types of shelters or settlements, as well as define the consequences of climate change on the mentioned factors. The flow of materials, resources, energy, food and other goods of the globalized world, from extraction from nature to consumption, are also crucial. Although architects are increasingly using recycled materials, the use and flow of resources needs to be radically re-examined along with their impact on all forms of environmental design. There is also a need to introduce several more courses, starting with psychology and mechanics of perception, which would be an informative basis for aesthetic theory and reasoning, through an introduction to phenomenology, all the way to environmental psychology and the psychological urge to bring order to the environment. Architecture can shape completely humane physical settings by relying on knowledge ranging from psychology to ancient spiritual traditions.

The struggle with the methods of traditional study, which emphasizes individuality and underestimates the importance of socio-political factors, began in the 1960s, and was again actualized at the beginning of the 21st century. Namely, emphasizing the social and ethical approach to architecture, some theorists are beginning to interpret architecture as a sociological discipline. As a result of the design solutions of the "star" architects, objects were created that face pure artistic expression, which is based more on the beliefs of the individual than on the needs of man and social factors. The essence was to strike a balance between the artistic and social paradigm and to train architects who would be socially and ethically responsible. In the new millennium, there is little empirical understanding of the problems in architecture. The cramped private world of 19th century architecture, separated from science and practical life, is still largely present today in architectural education and practice [23]. Therefore, different architectural examples from practice should be equally represented in the teaching of architectural design. It is also important to set certain theoretical disciplines on a practical level and to overlap with architectural design. Such confrontation with great changes in the world leads us to the conclusion that no theory will be able to solve the modern needs of society in terms of architecture and urbanization.

The last year, many architectural schools have replaced independent design theses with faculty-led research studies. Many large architectural firms are engaged in research. Research at colleges today suggests a wide field, from traditional archival research to robotic experiments and specialized research on environmental impacts.

The main focus of many schools remains teaching, but cooperation on research projects will play an important role in the future. In the complex definition of architectural design, research has become increasingly important. Practical work in a research study or workshop is a form of empirical learning. The changes reflected in the emphasis on practice-based research have been particularly visible in the last two decades. With their activism, some schools of architecture, through research studios and workshops, are introducing the education of architects based on empirical learning.

In the last two decades, there have been changes towards practice-based research. Clients asked architects to be more involved in programs and project development decisions that require a broad understanding of social, economic, and cultural variability. Architectural buildings today would have to meet higher environmental standards as well as energy standards. Materials and technologies are evolving rapidly, and architectural experts must keep up with that development.

The general discussion about what architecture is leads to a number of different conclusions. From the social aspect, architecture is an integral part of human activities. Cities, settlements and buildings have always been the result of cultural, social and economic factors of the environment, which requires a complex responsibility from the architect. Numerous

academic discussions have brought to light a deeper interest in the changed role of the architect in society. The general view is that the architect must rise from the manipulation of three-dimensional space and get closer to society. This would certainly contribute to architecture and architectural education taking a higher rank in the socio-political life of the communities in which they live, which is certainly one of the basic goals they strive for.

7. CONCLUSION

The modern concept of sustainable development, based on the creation of a new economic structure, rational use of natural resources and increasing flow and more efficient use of knowledge and capital, implies major changes in education of all professions, which should meet the requirements of the integrated market. Due to their increasingly rapid change, an era is coming in which technologies will play a more dominant role than ever before, which means that the requirements for both quantity and quality of engineers will change. areas of work. Therefore, countries that are more able, thanks to the national education system, to quickly form appropriate profiles of engineers, will be able to adapt more quickly to new market demands.

As the modern economy is by nature a dynamic system that leads to the rapid obsolescence of technology and technologically colored education, human intellectual capital needed for fierce market competition cannot be created in a static education system, and the education system must be dynamic and spreading the fundamental education of engineers, creates conditions for their continuous professional development.

Although the improvement of the higher education system is a continuous process, its necessity is especially evident when new knowledge emerges or when new technical challenges arise before society, as expected in the time to come. In that sense, the ability to solve problems creatively is recognized as one of the most important skills that architectural engineers should have. The fact that creativity is not exclusively an innate trait of an individual and can be developed by learning,

practicing and creating a creative environment is an additional challenge for the education system, which should further improve teaching itself, using proven models that include challenging models and skills development. creative solving.

During the contemporary discussions on architectural education, the situation from the end of the 1960s is again relevant, which requires a more responsible approach to the environment from architecture. Students should find a connection between climate and different cultural adaptations, such as types of shelters or settlements, as well as define the consequences of climate change on the mentioned factors. The flow of materials, resources, energy, food and other goods of the globalized world, from extraction from nature to consumption, are also crucial.

Architects are increasingly using recycled materials, the use and flow of resources needs to be radically re-examined along with their impact on all forms of environmental design.

LITERATURE

- [1] S. M. Malcom, The Human Face of Engineering, *Journal of Engineering Education*, 2008, 97(3), 237 – 238
- [2] T. P. Soubbotina, *Beyond economic growth: meeting the challenges of global development*, The World Bank, Washington, D.C., U.S.A. 2000.
- [3] D. Pupavac i D. Drakulić, *Ekonomija održivog razvoja*, XXII naučni skup međunarodnog značaja "Tehnologija kultura i razvoj", Palić 2015., str. 119-137
- [4] AGENDA 21, United Nations Conference on Environment & Development, Rio de Janeiro, Brazil, 3 to 14 June 1992.
- [5] B. Katalinić, idr., *Inženjeri za inovativno društvo*, XVII Skup trendovi razvoja: "EVROPA 2020: društvo zasnovano na znanju", Kopaonik, 07. - 10. 03. 2011., pp. 1-9
- [6] G. C. Giju et al., *Knowledge Management – the Key Resource in the Knowledge Economy*, *Theoretical and Applied Economics*, Vol. XVII (2010), No. 6(547), pp. 27-36
- [7] A. Sekulić: *Obrazovanje inženjera za tržišnu privredu – institucionalne pretpostavke*, *Tehnika, Mašinstvo*, Vol LII (1997) br. 5-6
- [8] S. Beechler, I. C. Woodward, *The global war for talent*, *Journal of International Management*, Vol. 15 (2009), pp. 273-285
- [9] M. Mesarović, *Intelektualni kapital kompanije za novi model održivog razvoja*, *Stručni časopis Energoprojekt*, br. 11, 2001, str. 19-25
- [10] C. Vest, *Context and challenge for twenty-first century engineering education*, *Journal of Engineering Education*, 2008, 97(3), 235-236
- [11] M. Jakovljević, idr., *Izazovi globalizacije i njihov utjecaj na privlačenje i zadržavanje talenata*, *Oeconomica Jadertina 2* (2012), pp 66-81
- [12] S. Beechler, I. C. Woodward, *The global war for talent*, *Journal of International Management*, Vol. 15 (2009), pp. 273-285
- [13] M. Krpan: "Značajke suvremenog inženjerstva", *Strojarstvo*, god. 38, br. 2-3 (1996), str. 71-72
- [14] *Educating the Engineer of 2020: Adapting Engineering Education to the New Century*, National Academy of Engineering, The National Academies Press, Washington, DC, 2005
- [15] M. Barbarić, *Obrazovanje inženjera za kreativno i inventivno djelovanje*, *Doktorski studij na FSB: Uvod u znanstveno istraživački rad 2015/2016*, Zagreb, 2015.
- [16] D. Golijanin, *Izazovi kreativnosti u obrazovanju inženjera*, 13. TELFOR, Beograd, 2005.
- [17] R. M. Castellanos, M. Y. Salinero, *Factors which cause enterprises to invest in training: The Spanish case*, *Zbornik radova Ekonomskog fakulteta, Rijeka*, Vol. 29(2011), No.1, pp. 133-151
- [18] A. H. Awang, et al., *Training Impact on Employee's Job Performance: A Self Evaluation*, *Ekonomika istraživanja*, Vol. 23(2010), No. 4, pp. 78-90
- [19] M. Roter-Blagojević: *Nastava arhitekture na višim i visokoškolskim ustanovama u Beogradu tokom 19. i početkom 20. veka*, *Godišnjak grada Beograda knj. XLIV*, 1997
- [20] B. Lj. Folić: *Nova škola arhitekture u Beogradu i promene u školovanju arhitekata 1968-1974* (doktorska disertacija odbranjena na Arhitektonskom fakultetu Univerziteta u Beogradu 2015. godine)
- [21] S. Kosanović, B. Folić: *Green themes in Architectural Curriculum-Scope and Content*, *Igra Ustvarijalnosti*, br.1, 2013
- [22] P. Buchanan: *The Big Rethink: Rethinking Architectural Education*, *Architectural Review*, no. 10, 2012
- [23] K. Rhowbotham: *Problem in the British Architecture School Regime*, *Architectural Review*, no.10, 2012.



Ljiljana Stošić Mihajlović, Ministry of construction transport and infrastructure,
stosicmihajlovicljliljana@gmail.com

Marija Mihajlović, Academy of Technical and Educational Studies in Niš,
mmihajlovic1251997@gmail.com

COMPATIBILITY OF EU AND SERBIAN ENERGY POLICIES WITH SPECIAL REFERENCE TO BUILDINGS

Abstract

The sustainable development of Serbia and the process of accession to the European Union cannot be viewed as separate or parallel processes, but represent a mechanism of holistic transformation of Serbian society into a sustainable community. It is a matter of normative regulation of the relationship between the new necessary values of true development. The process of harmonization of EU and Serbian energy policies in the construction sector is important, in terms of achieving energy efficiency of buildings. This paper deals with the issues of verification of national construction regulations on energy efficiency of buildings in order to achieve energy savings and strengthen market surveillance of energy efficient products implemented in EU member states.

Keywords: energy policy, energy efficiency, buildings

КОМПАТИБИЛНОСТ ЕНЕРГЕТСКЕ ПОЛИТИКЕ ЕУ И СРБИЈЕ СА ПОСЕБНИМ ОСВРТОМ НА ЗГРАДАРСТВО

Сажетак

Одрживи развој Србије и процес приступања Европској унији не могу се посматрати ни као одвојени ни као паралелни процеси, већ представљају механизам холистичке трансформације српског друштва у одрживу заједницу. Ради се о нормативном регулисању односа између нових неопходних вредности истинског развоја. Процес усаглашавања енергетских политика ЕУ и Србије у грађевинском сектору је важан, у смислу постизања енергетске ефикасности зграда. Овај рад се бави питањима верификације националне грађевинске регулативе о енергетској ефикасности зграда у циљу постизања уштеде енергије и јачања тржишног надзора енергетски ефикасних производа који се спроводи у земљама чланицама ЕУ.

Кључне ријечи: енергетска политика, енергетска ефикасност, зградарство.

1. INTRODUCTION

The energy market is a single system, which means that disruptions in one region will be transferred to the functionality of global energy supply. The protection of national markets cannot be effectively ensured without a legally stable regulation of the international legal framework for energy supply, based on the need to prevent and eliminate existing distortions in energy supply. The Republic of Serbia, as a member of the European Energy Community, is continuously harmonizing regulations with EU regulations, which, along with Russia, is our most important energy partner. [1] Energy is of great importance in the world economy. Tendencies point to further growth in world consumption energy, to in the period from 2015 to 2040 increase by 28%. They stand out as the biggest future consumers of energy industry, transport and construction. The industry is expected to survive leading position in energy consumption with a share of 50% (increase of 0.7%), but also that annual energy consumption will grow somewhat faster in the field of transport (1% per year) and construction (1.1% per year). [2]

Many believe that population and environmental issues will be key political issues on the global agenda of the 21st century in an economically and ecopolitically interdependent world. According to the FAO (Food and Agriculture Organization), in 2050, 9.1 billion people will live on Earth. The current course of the 21st century is the stage of a great demographic transition or a new migration of peoples. Scientists gathered in the organization TWI2050 claim that the world is at a crossroads and that the achievement of global goals of sustainable development, set for 2030, but still requires urgent and major transformation of society, economy and technology without precedent, and that the six most important areas or drivers: human capacity and demography; sustainable consumption and production; decarbonization and energy; food, biosphere, water and oceans; smart cities; and the digital revolution. They also remind that the world should no longer be comfortable, because the necessary changes in two of the three fields of sustainable development (society and environment) are happening too slowly. [3]

The 3P model (people, planet, profit) did not lead to the establishment of sustainable production, which returns more to nature than it took. The business sector continues to visibly reluctantly and above all cosmetically transform the current unsustainable way of making industrial production on the principle of take-make-waste into an incomparably more responsible concept from cradle-to-cradle, a concept that could be recognized in the circular economy, as creations of the blue economy direction of an economic school in Berlin. Sustainable forms of consumption and production make up the bloodstream of sustainable development. According to the attitude towards consumption and production, the level of maturity and culture of a society can be seen. The critically low level of environmental culture reflects the importance of the interconnectedness of the dimensions of sustainable development. The causes are numerous, dominated by non-social and economic ones, and the responsibility is mutual - both on the side of consumers and on the side of producers. Irresponsible production, wasteful consumption, resource inefficiency, food waste, generation of unacceptably large amounts of waste are obstacles to achieving sustainable development of local communities. And it is as if one forgets that the right to enjoy the benefits of sustainable consumption and production is a human right. Neglecting the rights of others (meaning everyone and everyone) to truly sustainable development, man shamelessly and relentlessly usurps and destroys nature, thereby endangering the statics of the very foundations of humanity. Although we sometimes don't see them, we all feel the effects of climate change. They know no boundaries. Climate diplomacy, as a new science of overlapping all interests and relations, obliges to urgent action for climate. The new climate change policy is a new 3P model - an opportunity, a call and an attempt to build a green economy and green growth. It will be a challenge worth the 21st century.

Institutionalization, public advocacy and sustainable development policy in Serbia are experiencing a qualitative acceleration in the period 2014-2015. years. At that time, the relationship between Serbia and the international community was further expanded by the United Nations Agenda for Sustainable Development until 2030, while on the other hand, the relationship between Serbia and the European Union culminated in opening Serbia's accession process to the European Union.

2. MAIN REGULATORY MECHANISMS.

By accepting the 2030 Agenda, Serbia has decided to implement international policies of sustainable development with full respect for the principles and values established by it. The 2030 Agenda represents the global development agenda for the period after 2015. This is the first international agreement that has clearly recognized the central role of effective, inclusive, and accountable institutions in the development process. Also, the Agenda shifts the focus when it comes to understanding development and shifts from meeting the most basic needs to promoting the realization of human rights, recognizes that growing inequalities pose a threat to the economy and social fabric, and seeks to reduce inequalities within and between countries. Of the 17 sustainable development goals, most are related to the environment:

- a world without poverty: end poverty everywhere and in all its forms.
- A world without hunger: end hunger, achieve food security and improved nutrition, and promote sustainable agriculture.
- good health: ensure a healthy life and promote well-being for people of all generations.
- quality education: provide inclusive and quality education and promote lifelong learning opportunities.
- Gender equality: achieve gender equality and empower all women and girls.
- clean water and sanitary conditions: provide sanitary conditions and access to drinking water for all.
- Affordable and renewable energy: ensure access to affordable, sustainable, sustainable and modern energy for all.
- Decent work and economic growth: promote inclusive and sustainable economic growth, employment and decent work for all.
- Industry, innovation and infrastructure: build adaptable infrastructure, promote sustainable industrialization and encourage innovation.
- Reducing inequality: reduce inequality between and within countries.
- Sustainable cities and communities: make cities and human settlements inclusive, safe, adaptable and sustainable.
- responsible consumption and production: ensure sustainable forms of consumption and production.
- Climate action: take urgent action to combat climate change and its consequences.
- life under water: preserve and sustainably use the oceans, seas and marine resources.
- land life: sustainably manage forests, combat desertification, stop and reverse land degradation and prevent the destruction of biodiversity.
- Peace, justice and strong institutions: promote peaceful and inclusive societies for sustainable development, ensure access to justice for all and build efficient, reliable and inclusive institutions at all levels.
- partnership to the goal: to strengthen the global partnership for sustainable development.

Serbia's commitment to striving to meet new global goals of sustainable development adds a new dimension to its European integration. The beginning of accession negotiations brought Serbia many challenges and obligations, but also rights and opportunities. In the public discourse of the process of Serbia's accession to the European Union, the role of the strongest initiator of comprehensive reforms necessary for the development of policies and institutions that support sustainable development has been given. In the decade for us, Serbia has been implementing the most important reform processes through the Instruments for Pre-Accession Assistance (IPA programs).

With the sign of the new strategy of sustainable development of the European Union, the European Green Agreement affirms green growth as the only possible roadmap to sustainable development. Formally, it is an integral part of the European Commission's Strategy for Implementing the 2030 Agenda and meeting the Sustainable Development Goals. "A new growth strategy aimed at transforming the European Union into a just and prosperous society, with a modern and competitive resource-efficient economy, with net zero-emission greenhouse gas emissions by 2050, and decoupled economic growth resources." [4]

The European Green Agreement [5] was presented in 2019 as one of the six priorities of the new European Commission for the period until 2024. It forms the basis for fulfilling the obligations from the Paris Agreement. The plan seeks to halt climate change by achieving more sustainable economic growth, which is in fact a recognition that sustainable growth depends on the development of a green, circular and low-carbon economy (new sustainable economic triads). The European Green

Agreement is an indicator from the domain of public policies that green growth is a prelude to sustainable development, that green growth leads to sustainable development, or more precisely - that green growth is a prerequisite for sustainable development. Formally, it is an integral part of the European Commission's Strategy for Implementing the 2030 Agenda and meeting the Sustainable Development Goals.

The Clean Energy for All Europeans package includes energy efficiency, renewable energy sources, the electricity market model, security of electricity supply and governance rules for the Energy Union. It has three main goals: prioritizing energy efficiency, achieving global leadership in renewable energy and ensuring a fair solution for consumers. Measures include initiatives to accelerate innovation related to clean energy and the renovation of European buildings, as well as measures to: encourage public and private investment, and industrial initiatives; reducing the impact of the transition to smart and clean energy on society; involvement of all institutional, business and social partners; maximizing European leadership in clean energy technologies and services to help third countries achieve their clean energy policy goals.

Clean energy for all Europeans contains two annexes on accelerating the introduction of clean energy in buildings and on activities to encourage the transition to clean energy. The positive effects of an integrated approach are especially expected in the areas of reducing energy poverty, launching local green growth and job creation.

3. ENERGY EFFICIENCY POLICY IN THE CONSTRUCTION OF THE EUROPEAN UNION

Communication 2013/520 on the contribution of EE to energy security and the objectives of Framework 2030135, the EU focuses on encouraging consumers in terms of building quality by strengthening local and regional verification of national building regulations and accurately informing consumers about energy efficiency of buildings for sale or rent. with customers in order to save energy, and strengthen market surveillance of EE products to be implemented in all Member States and to ensure a level playing field for industry, and to provide consumers with the information they need when making a purchase decision. The basis of the regulatory framework is Directive 2012/27 on energy efficiency.

The Framework Directive clearly supports low-carbon development goals, recognizing EE as a cost-effective means of tackling climate change to mitigate GHG emissions, reduce energy imports, increase security of energy supply, accelerate innovation and technology, and improve economic growth and industrial competitiveness. When it comes to its scope, it refers to EE in service industries, industry, buildings, products and transport; it basically creates framework rules that cover the entire energy chain (energy production - transmission - distribution - use).

Focusing on EE in buildings, the Directive requires Member States to adopt a long-term strategy to mobilize investment in the renovation of national buildings (residential, commercial, private and public), including the following elements: review of national housing stock based on statistical sampling; policies and incentives for cost-effective renovation of buildings (including financial incentives); adoption of building codes that promote RES and EE in buildings; an assessment of the expected evidence-based energy savings. It is interesting that the Directive calls on public authorities to set an example in buildings and procurement. Articles 5 and 6 require Member States to achieve the following:

- 3% of the total area of heated and / or refrigerated buildings owned and occupied by the central government is renewed every year to meet at least the minimum energy performance requirements set by Directive 2010/31 / EU on the energy performance of buildings.
- Governments purchase only products, services and buildings with high energy efficiency, to the extent that this is in line with economic feasibility, greater sustainability, technical convenience, as well as sufficient competition.

Articles 9-12. prescribe rules to ensure that consumers can monitor and become aware of energy use and possible savings, by the following means:

- to the extent technically possible, financially reasonable and proportionate to the potential energy savings, final consumers of electricity, natural gas, district heating, district cooling and domestic hot water shall receive individual meters at competitive prices that accurately reflect actual energy consumption. end-user and which provide real-time usage information (so-called smart meters);
- accurate and transparent payment information is provided to final consumers at no additional cost;

- Small energy consumers will be introduced to EE measures, as well as fiscal incentives to promote behavioral choices in EE.

Directive 2010/31 / EU on the energy performance of buildings [6] applies to all new buildings (residential, commercial, public and private), as well as existing buildings undergoing major renovations. The aim of the Directive is to reduce energy consumption and GHG emissions from buildings, by promoting improvements in their energy performance. Energy efficiency of buildings means the calculated or measured amount of energy required to meet energy demand with typical building use, which includes, but is not limited to, energy used for heating, cooling, ventilation, hot water and lighting. The energy effect of a building must be expressed in a transparent manner and include an energy performance indicator and a numerical primary energy indicator, based on primary energy factors per energy carrier, which may be based on national or regional annual weighted averages or specific on-site production values.

To this end, the following obligations have been established for Member States:

- adoption of a common methodology for assessing the energy performance of buildings in the European Union;
- setting minimum requirements for the energy performance of new buildings, existing buildings that are subject to major renovations and technical construction systems whenever they are installed, modified or upgraded;
- adoption of national plans to increase the number of facilities that are at a level close to zero consumption; - establishing a system of energy certification of buildings based on common standards and levels; According to Art. 11–17. Directive, the following rules apply to the energy certification system:
- the energy performance certificate will contain the building's energy performance and benchmarks such as minimum energy performance requirements, to allow building owners or tenants to compare and evaluate its energy performance;
- the certificate may contain additional information such as annual energy consumption for non-residential buildings and the percentage of energy from renewable sources in total energy consumption;
- as well as recommendations for optimal cost or economic improvement of the energy performance of the building, unless there is a reasonable potential for such improvement compared to the applicable energy performance requirements. Recommendations in the energy performance certificate will include: measures to be taken in connection with major renovations of the building facade or technical construction system (s); names for individual building elements regardless of major renovations of the building facade or technical construction system.
- ensuring regular inspection of heating and cooling systems by independent, qualified experts and publishing inspection reports; - the adoption of adequate, proportionate, effective penalties applicable to breaches of the obligations laid down in the Directive. [7]

Directive 2009/125 / EC on eco design requirements for energy-related products covers a wide range of products (not only energy devices but also windows, insulation materials, water-using products), which are widely used in construction and have great potential. to save energy. The Directive aims to establish a single EU-level framework for eco design requirements for energy-related products to ensure that they are freely placed on the EU market and contribute to sustainable development, energy security, environmental protection and EE improvement. Given that energy-related products represent a large part of the consumption of natural resources and energy, a preventive approach will be taken at an early stage of their life cycle, ie at the design stage, in order to minimize negative environmental impacts, including pollution reduction. waste and GHG emissions they generate, without compromising their functional qualities. The directive does not set emission limit values for products falling within its area, but explicitly states clear eco-design parameters that will be satisfactory in order to be placed on the EU market. Its regime applies to energy-related products defined in Article 2 as: "Any good that during use affects the consumption of energy placed on the market and / or put into service, and includes parts that are intended to be incorporated into products related to for energy covered by this Directive, which are placed on the market and / or put into service as individual parts for end-users and for which, independently, environmental impacts can be assessed."

In accordance with Art. 3-9, Member States and manufacturers / importers of energy related products are obliged to fulfill the following obligations:

- Member States will ensure that only energy-related products that comply with the requirements of the Directive are placed on the EU market; and designate national market

surveillance authorities, which have the right to: verify the product's compliance with the requirements, request the necessary information from manufacturers to carry out controls and withdraw non-compliant products from the market;

- manufacturers will assess their energy-related products before placing them on the market, in order to verify their compliance with the requirements of the Directive; ensure that their energy-related products comply with the requirements of the Directive and require a declaration of conformity to label the product; ensure that the energy-related product contains information on their environmental impact and environmental profile (description of "inputs" and "outputs", such as raw materials, emissions and waste, associated with the product throughout its life cycle that are significant from the point of view of its impact on the environment and are expressed in measurable physical quantities); and will provide consumers with all relevant information on the environmental impact of energy-related products (ie the environmental profile and role that consumers can play in order to maximize the sustainable use of the product). Directive 2018/844143 amending Directive 2010/31 / EU on the energy performance of buildings and Directive 2012/27 / EU on energy efficiency states that each Member State shall establish a long-term strategy to support the renewal of the national fund for residential and non-residential buildings, public and private, in energy-efficient and decarbonized building stock by 2050, facilitating cost-effective conversion of existing buildings into near-zero energy buildings. [8]

Considering the impact of fossil fuel-based energy, the European Union has decided to put the solution to this challenge high on its political agenda: after the renewable energy, energy efficiency and greenhouse gas emission reduction targets for 2020 (table 1), the EU has set itself even higher goals in the same areas for 2030. [9]

Table 2. Energy and climate goals EU 2020 - 2030. (relative to 1990)

Participation of renewable sources	20%	32%
Energetic efficiency	20%	32,5%
Reducing greenhouse gas emissions	20%	40%

3.1. EU SMART CITIES INITIATIVE

“The EU's long-term vision for climate and energy dates to 2050 and is presented in two most important strategic documents: Energy Roadmap 2050 4, and Roadmap for moving to a competitive, low-carbon economy by 2050 - A Roadmap for moving to a competitive low carbon economy in 2050. These documents contain a lot ambitious related climate and energy goals of the EU, which intends to commit to reduction of greenhouse gases by 80-95% compared to the base year 1990. Achieving this goal, at the same time it is important to enable energy security and competitiveness.” [10] The goal of this initiative, adopted in 2012, which addresses multisectoral issues in the field of energy, transport and information and communication technologies (ICT), is to stimulate the development of innovative solutions to increase EE and sustainability of urban transport. The initiative works synergistically in several closely related and interdependent areas: smart buildings and neighborhoods; smart systems and supply and demand services to provide better information to citizens; sustainable urban mobility; smart and sustainable digital infrastructure; and strategic planning to identify, integrate, and optimize flows. The regulatory framework of importance for the green economy is based, inter alia, on the following acts:

- Regulation on type-approval of motor vehicles with regard to emissions from light passenger and commercial vehicles (Euro 5 and Euro 6) and access to vehicle repair and maintenance data;
- Decree amending the Decree on monitoring CO₂ emissions from new passenger cars;
- Regulation amending Regulation 443/2009 to determine how to achieve the goal of reducing CO₂ emissions from new passenger cars by 2020;
- Regulation on the type-approval of motor vehicles and engines with regard to emissions from heavy vehicles (Euro VI) and on access to information for the repair and maintenance of vehicles and amending Regulation (EC) no. 715/2007 and Directive 2007/46 / EC and repealing Directives 80/1269 / EEC, 2005/55 / EC and 2005/78 / EC;
- Framework Directive establishing a framework for the type-approval of motor vehicles and their trailers, as well as the composition, components and special technical units intended for such vehicles. [11]

“The biggest obstacle to increasing energy efficiency is the lack information on prices and availability of new technology, as well as technical barriers such as the lack of standardization of

equipment and components. Improvement regulatory regime in the EU and identifying more transparent market trends thanks to liberalization it should solve these problems.” [12] Serbia presented its own obligations to reduce carbon emissions by 9.8% by 2030, in compared to 1990. However, its emissions continue to grow by about 80%. [13]

3.2. CONSTRUCTION REGULATIONS

Key elements of the Energy Performance of Buildings Directive are the obligation of EU member states to establish long-term reconstruction strategies, with the goal decarbonization of construction funds by 2050 with the obligation to develop minimum energy performance requirements for buildings; installing chargers for electric vehicles; system installation heating and air conditioning. In this context, all new buildings they must have zero energy consumption, and members must ensure that certificates of energy performance are issued when buildings are sold. The Building Energy Performance Directive promotes smart technologies, including automation requirements and building management systems and devices that regulate room temperature. The action plan for the energy renovation of buildings contains an action plan with specific regulatory, financial and measures to encourage the renovation of buildings. The goal of the renovation wave strategy is to double the annual rate of energy renovation of buildings by 2030. [14]

With the new Law on Construction Products, the regulation is partially harmonized with the relevant secondary sources of EU law, and fully harmonized with Regulation 157/2014 on the conditions for making the declaration of performance available on the website and Regulation 568/2014 amending Annex V of Regulation 305/2011 on the assessment and verification of the constancy of performance of construction products, in part with Regulation 305/2011 on prescribing harmonized conditions for placing the "Official Gazette of RS", No. 120/17. "Official Gazette of RS", No. 83/18. 219 construction products on the market²⁵⁴, while there was no compliance with Regulation 1062/2013 on the format of the European Technical Assessment for construction products and Regulation 574/2014 amending Annex III of Regulation 305/2011 on the model for drawing up a declaration of performance of construction products. In the previous period, several bylaws were passed, such as the Rulebook on Cement Quality ("Official Gazette of RS", No. 34/13 and 44/14), the Decree on technical and other requirements for steel for concrete reinforcement "" Official Gazette of RS ", No. 35/15 and 44/16), Regulations on technical and other requirements for structural cold-formed welded hollow profiles of non-alloy and fine-grained steels ("Official Gazette of RS", No. 93/15) and Regulations on technical and other requirements for ash, as construction material intended for use in the construction, reconstruction, rehabilitation and maintenance of public infrastructure facilities ("Official Gazette of RS", No. 56/15), but not the expected Regulation on construction products.

The law is a step towards establishing a national system of infrastructure for the quality of construction products, which protects the environment. This law regulates the conditions for placing on the market and making available on the market of construction products, making declarations of performance and putting the mark of conformity on construction products, obligations of economic entities, technical regulations for construction products and Serbian technical specifications, simplified procedures, technical evaluation bodies, bodies for assessment and verification of constancy of performance of construction products, validity of documents on conducted assessment and verification of constancy of performance of construction products and signs of conformity issued abroad. Thus, buildings as a whole and their special parts must meet the intended use, taking into account the health and safety of people throughout the life cycle of these buildings, and provided normal maintenance during economically acceptable service life must meet seven basic requirements for buildings: mechanical resistance and stability; fire safety; hygiene, health and the environment; safety and accessibility during use; noise protection; energy saving and heat retention; sustainable use of natural resources.

In terms of energy savings and heat retention, facilities and their installations for heating, cooling, lighting, and ventilation must be designed and constructed in such a way that the amount of energy that 254 Regulation EU / 305/2011 of the European Parliament and of the Council laying down harmonized conditions for the marketing of construction products and repealing Council Directive 89/106 / EEC. 220 require during use to be low when users and site climatic conditions are taken into account; they must also be energy efficient, using as little energy as possible during construction and demolition. Regarding the sustainable use of natural resources, facilities must be designed, constructed and demolished in such a way that the use of natural resources is sustainable, and in particular to ensure:

- reuse or possibility of recycling of buildings, its materials and parts after demolition.
- durability of the facility.

- use of raw materials and secondary materials in the facility, which are suitable for the environment. The Law on Amendments to the Law on Planning and Construction has been harmonized with Regulation 347/2013 on guidelines for trans-European energy infrastructure and further with the INSPIRE directive.

The novelties are that the certificate on energy performance of buildings is issued through the Central Register of Energy Passports, that the environmental impact assessment procedure takes place in the process of obtaining location conditions, as well as the introduction of new institutions: Sustainable Urban Development Strategy and National Architectural Policy. The energy rehabilitation of the building is also being introduced with the aim of increasing the energy efficiency of the building and the requirement that construction products must meet technical requirements from the aspect of climatic features of the Republic of Serbia. By the way, the process of energy certification of buildings in Serbia began in 2012, when the application of regulations in the field of energy efficiency of buildings became mandatory.

On the basis of the Law on Planning and Construction, ordinances have been adopted which prescribe procedures for improving the energy efficiency of buildings: - Ordinance on energy efficiency of buildings ("Official Gazette of RS", No. 61/11), which prescribes energy properties and calculation of thermal properties of high-rise buildings, as well as energy requirements for new and existing buildings; and 255 "Official Gazette of RS", no. 72/09, 81/09 - corrected, 64/10 - US, 24/11, 121/12, 42/13 - US, 50/1 - US, 98 // 13 - US, 132/14, 145 / 14 and 83/18.

The Central Register of Energy Passports (CREP) is an information system through which certificates on energy performance of buildings are issued and in which databases are kept on authorized organizations that meet the prescribed conditions for issuing certificates to responsible engineers for energy efficiency of buildings employed in these organizations. and issued certificates on the energy performance of buildings.

Rulebook on conditions, content, and manner of issuing certificates on energy performance of buildings ("Official Gazette of RS", No. 69/12 and 44/18 - other law), which prescribes in more detail the conditions, content and manner of issuing certificates on energy performance of buildings. A certificate or energy passport is a document that contains calculated values of energy consumption within a certain category of buildings, energy class and recommendations for improving the energy performance of the building.

4. CONCLUSION

The main characteristic of the energy sector in the Republic of Serbia is vulnerability. This is confirmed by the fact that it is a matter of production electricity and heat accompanied by high costs and environmental pollution. Also, the energy sector in Serbia is characterized by centralized energy production; tall energy intensity of the economy; pronounced dependence on domestic fossil fuels (in the production of primary energy, the share of the lowest quality coal - lignite, is as much as 68%). All the legislation mentioned in the text is important for the energy policy of Serbia, with special reference to its impact on the construction sector, not only from the point of view of joining European integration, but more as an example of good practice. Namely, given that Serbia is highly energy dependent or poor in energy sources, and having in mind global trends in energy policy development in the environmental sector, we believe that the following directions of further energy development in Serbia are important: 1. Increasing energy efficiency ; 2. Increasing the share of renewable energy sources; 3. Use of waste from various sources as raw materials for energy production with a positive effect on reducing pollution; 4. Consistent application of regulations to reduce environmental pollution, in particular to reduce carbon dioxide emissions and emission limit values; 5. Deregulation of the energy market with consistent emphasis on distributed energy production; 6. Development and implementation of incentive measures to encourage investment in the energy sector, especially in the construction sector.

LITERATURE

- [1] Dimitrijević, Ž. (2015). Sigurnost snabdevanja tržišta energenata kao pravopolitička paradigma regulatornog okvira. Doktorska disertacija, Univerzitet u Nišu, Pravni fakultet.
- [2] Kokeza, G. (2018). Restrukturiranje energetskog sektora Srbije u cilju povećanja efikasnosti i održivosti. Ekonomski vidici, XXIII, Br. 3-4, str. 52
- [3] The World in 2050: Transformations to Achieve the Sustainable Development Goals. Report prepared by The World in 2050 Initiative, International Institute for Applied Systems Analysis, Austria, 2018.

- [4] https://ec.europa.eu/neighbourhood-enlargement/sites/default/files/factsheet_green_agenda_en.pdf
- [5] Communication from the Commission to the European Parliament, the European Council, the Council, the European Economic and Social Committee and the Committee of the Regions: The European Green Deal. COM/2019/640 final.
- [6] Directive 2010/31/EU of the European Parliament and of the Council on the energy performance of buildings
- [7] Directive 2009/125/EC of the European Parliament and of the Council on establishing a framework for the setting of eco-design requirements for energy-related products
- [8] Directive (EU) 2018/844 of the European Parliament and of the Council amending Directive 2010/31/EU on the energy performance of buildings and Directive 2012/27/EU on energy efficiency.
- [9] Aleksić, V. (2022). Klima, životna sredina i energetska politika. Dostupno na: <https://bfpe.org/u-fokusu/bfpi-liderski-program-fokus/en> (Pristupljeno:15.05.2022.)
- [10] Macura, A. (2014). Transparentnost energetske odlučivanja na lokalnom nivou. Beogradska otvorena škola.
- [11] COM(2012)4701 final Communication from the Commission Smart Cities and Communities – European Innovation Partnership.
- [12] Rakić, B. (2008). Energetska politika EU u uslovima globalizacije. Časopis "EKONOMSKE TEME" Godina izlaza XLVI, br. 3, 2008., str. 1-16
- [13] Djukić, P., Batas Bijelić, I. (2018). Srbija pred izazovima tranzicije energetske sektora. Ekonomski vidici, XXIII, Br. 3-4, str. 22
- [14] Daković, D. (2022). Energetsko zakonodavstvo Evropske unije. Bilten AERS, br.555



Jelena Pavlović, University of Belgrade, j.pavlovic.phd@edu.arh.bg.ac.rs

Ana Šabanović, University of Belgrade, ana.sabanovic@arh.bg.ac.rs

Nataša Ćuković Ignjatović, University of Belgrade, natasa@arh.bg.ac.rs

ENERGY EFFICIENCY IMPROVEMENTS OF THE BUILDING STOCK: REPUBLIC OF SERBIA LEGISLATION COMPLIANCE TO THE EUROPEAN UNION

Abstract

The paper analyses the notion of improving energy efficiency, as a means of increasing sustainability by lowering energy demand in the building sector globally, also acknowledged in Serbian law-making through regulations aimed towards its advancement. EU Candidate Country status imposes changes to the existing legislative and strategic framework regarding following its directives, which then become incorporated into the laws, regulations, and standards of the Republic of Serbia. By means of descriptive content analysis, official documents related to energy efficiency in architectural design and construction are reviewed in order to determine its scope and raise awareness of the levels and opportunities of upgrading the building stock that such legislative framework supports.

Keywords: sustainability, directives, regulations, energy efficiency, building stock

УНАПРЕЂЕЊЕ ЕНЕРГЕТСКЕ ЕФИКАСНОСТИ ИЗГРАЂЕНОГ ФОНДА: УСКЛАЂЕНОСТ ЗАКОНОДАВСТВА РЕПУБЛИКЕ СРБИЈЕ СА ЕВРОПСКОМ УНИЈОМ

Сажетак

Рад анализира појам унапређења енергетске ефикасности, као глобалну меру унапређења одрживости кроз смањење потражње енергије у грађевинском сектору, какав је препознат и у српској легислативи. Статус земље кандидата за приступање ЕУ намеће измене постојећег законодавног и стратешког оквира пратећи њене директиве, које се потом инкорпорирају у законе, прописе и стандарде Републике Србије. Дескриптивном анализом садржаја врши се ревизија званичних докумената који се односе на енергетску ефикасност у архитектонском пројектовању и изградњи у циљу утврђивања његовог обима и подизања свести о нивоима и могућностима унапређења грађевинског фонда које такав законски оквир подржава.

Кључне ријечи: одрживост, директиве, прописи, енергетска ефикасност, грађевински фонд

1. INTRODUCTION

The Long Energy Crisis or “oil embargo” occurred in 1973 causing a shock, followed by the second oil crisis in 1979 and global political and economic effects. The events forced a change of attitude towards energy production and consumption. [1] As a result, during the last half-century, the world has made significant gains in energy productivity, since the oil shocks brought energy demand and vulnerability to energy supply disruptions into focus. [2] They incited a variety of policies at the global, European, national, regional, and local level, as well as actions performed by governments, companies, and non-profit organizations.

The overall influence of energy sector has brought up major concerns, and in addition to these challenges the world started to notice other environmental problems. Responsible management of resources, and energy efficiency as its specialized part, has been identified at an early stage as a key strategy for energy saving and raising energy self-reliance. [3] The energy challenges the world has faced from the 1970s to the 1990s provided experiences and lessons to be applied in the following decades. Energy efficiency concept is a vital source and guide to any future global, European, or national energy-saving strategy.

Current increase in emissions within the building sector is happening due to a continued use of coal, oil and natural gas. Combined with high activity levels in regions where electricity remains carbon-intensive, it results in a steady level of direct emissions, but also growing indirect emissions (i.e., electricity). Electricity consumption in building operations represents more than a half of global electricity consumption. [4]

Since the building sector is accountable for 40% of consumption of total energy generated [5, 6], the requirement for energy efficient improvement of envelopes and systems for new buildings was introduced with a goal of minimizing primary heat losses. A set of parameters was defined in order to assess if a building was fit for use. New buildings consume less energy according to code, but are outnumbered by the existing ones, which need a significant amount of energy resources for operating. Hence, energy efficiency improvements of the existing building stock are inevitable in the process of minimizing current energy demands. In that sense, even the United Nations proposed an implementation plan for sustainable urban development within the New Urban Agenda [7] which focused on improving energy efficiency and sustainable land use in its several sections. Also, a significant part of the present building stock represents built heritage, not primarily considered for energy performance enhancements due to constraints regarding the preservation of their cultural value.

When considering sustainability within architecture and construction, and its practical regulation, we consider the determinants of the United Nations above all, but the Candidate Country status of the Republic of Serbia for accession to the European Union brings further rules in the form of preconditions that must be met in order to complete the process. A number of them presume changes to the existing legislative and strategic framework, as well as its adjustment and harmonization with current EU policies. They are initially introduced into national strategies, which then became incorporated in laws, regulations, and standards of the Republic of Serbia.

As a research method, descriptive content analysis was used for official documents from the field of environmental studies and sustainable development that are related to the discipline of architecture and construction, and in which the concept of energy efficiency was identified. Within the actual analysis, the sources are arranged primarily grouped in two segments, according to the hierarchy of document issuers – European Union and the Republic of Serbia, in order to determine the notion of compliance. The first segment of the analysis contains directives and other relevant legislative documents of the European Union that became mandatory for Serbia through the conditions of the stabilization and association process. They are arranged chronologically according to the development of the concept and implementation mechanisms of energy efficiency. The second segment contains the analysis of legislative documents of the Republic of Serbia set according to the rule of legality, from general to specific: strategic documents, laws, regulations, and standards. After reviewing all the individual documents, concluding remarks were made.

2. RECOMMENDATIONS OF THE EUROPEAN UNION ON ENERGY EFFICIENCY

According to the Stabilisation and Association Agreement with the European Union, the Republic of Serbia is obliged to harmonize its own regulations with the EU directives and development strategies. Therefore, this chapter provides overviews of EU documents that introduce changes and the creation of Serbian legislation in the field of energy efficiency in architectural design and

construction. Reviews are given in order to show their individual role in the development of Serbian legislation on the matter, which is presented in chapter 3.

2.1. EU DIRECTIVE ON THE ENERGY PERFORMANCE OF BUILDINGS

This Directive [5] was adopted by the European Parliament and the Council in 2010, as a modification of a previous version from 2002, in order to both clarify the notion of buildings' energy performance and to amend its content. The aim of the document was promoting improvements of the energy performance of buildings in the European Union by laying down requirements for calculations and their minimum values that are to be applied in new buildings, existing buildings, building elements and technical systems. Its implementation requires introduction of national plans by Member Countries for nearly zero-energy buildings, energy certification, regular inspection, and independent monitoring.

Specifically, the document states that a reduction in energy consumption, along with the use of renewable resources, is critical for a decrease in greenhouse gas emissions. Therefore, it is important to reduce building energy needs by enhancing their energy efficiency, as their share of consumption is as high as 40% in energy generated.

Thermal characteristics, followed by heating and cooling calculations, energy from renewables, passive heating and cooling, shading, air quality, natural lighting, and overall design – are all to be included in methodology of determining the energy performance of buildings. According to existing EU standards, annual energy performance represents all the energy needs of a building that is to be used for temperature maintenance and domestic hot water throughout a year. Based on this estimation, building certification is organized along with procedures for its implementation and control.

In accordance with local conditions, a minimum of requirements is to be set for energy performance in new structures, as well as buildings undergoing major renovations, apart from protected structures. Recommendations for energy efficiency improvements are to be applied especially to public buildings, in order for public authorities to "lead by example" to promote the concept. European funds, transmitted through national, regional, and local funds, serve to support green technologies and development of energy efficient systems.

2.2. EU DIRECTIVE ON THE ENERGY EFFICIENCY

The Directive 2012/27 [8] was adopted in 2012 by the European Parliament and the Council to ensure the achievement of saving 20% of the Union's primary energy consumption by 2020, with defining thoroughly the notion of energy efficiency as a means of mitigating climate change and securing energy supply. For all Member States, implementation is required on a national level through strategic targets.

Document considers the fact that energy efficiency primarily decreases energy consumption, thus decreasing energy imports. Also, it lessens the effects of climate change by directly reducing emissions, and innovation development that follows it provides new business opportunities that strengthen economic growth. In computational sense, energy efficiency represents the ratio of performance, services, goods, or energy to energy intake. Elements that form the building envelope are the ones particularly important for setting energy performance requirements.

It is noted that there is an evident need for an investment strategy in the renovation of residential and commercial buildings to improve the energy performance of the building stock, because of the high share of buildings' energy consumption in the European Union. There is a need of introducing annual renovation rates of at least 3% for publicly owned buildings larger than 500m² (or 250m² starting from 2015), so that they meet the minimum requirements. Furthermore, the directive requires that energy efficiency is introduced as one of the preconditions for public procurements. Also, the citizens are to be included in the development and application of energy efficiency and informed about the progress by their local governments. Certain measures of implementation are energy audits, smart meters, and consumption-based charging for at least 80% of consumers, as well as certification arrangements for energy efficiency improvements. Heritage buildings, defence facilities and places of worship do not necessarily fall under this rule.

2.3. EU DIRECTIVE ON THE ENERGY PERFORMANCE OF BUILDINGS AND ENERGY EFFICIENCY

The document [9] was adopted by the European Parliament and the Council in 2018 as an amendment to the previous Directives in order to review the measures needed for reaching projected targets, since an estimation was made that they were not on track at the moment.

With the security of energy supply of the European Union, its competitiveness and sustainability in mind, the most important commitments are the reduction of greenhouse gas emissions by 40% compared to 1990 before 2030, increase of renewable energy share in consumption, energy savings, and other activities. The building stock, being responsible for 36% of all carbon dioxide emissions in the Union, is to be decarbonized by ultimately obtaining all energy from clean sources by 2050. Goals and actions for energy efficiency are to be prepared by each Member State individually, with setting long-term renovation strategies and expected results.

The directive demands that both energy efficiency and the use of renewables are enhanced, because buildings take up to 80% of all energy used for heating and cooling (which sums to 50% of energy spent in the EU). Increasing the number of deep renovations with clear guidelines and measurable activities has the aim of transforming existing structures into "Nearly Zero Energy Buildings". The document restates the significance of promoting skill development and education in energy efficiency and building in general, as well the need for an annual renovation rate of 3%. Energy performance certification transparency and providing all necessary parameters for calculation is required, but we are not to focus only on the envelope. Instead, we are to include all relevant elements and technical systems to improve thermal and visual comfort in a building, such as passive elements for reducing the energy needed for heating or cooling, lighting, and ventilation. Self-regulating systems and innovations that integrate renewable energy sources into smart supply networks and smart buildings are encouraged. Decarbonized, energy-efficient building stock and the transition to almost energy-neutral buildings is the goal, encouraged even when protecting and preserving cultural heritage.

2.4. EUROPEAN GREEN DEAL

An ambitious response to raising concerns about the environmental problems and climate changes comes in form of "The European Green Deal" [10], adopted by the European Commission in 2019, still leaning on the basis of the Paris Agreement [11] while setting a new path for sustainability. Zero net greenhouse gas emissions by 2050 and estimating economic growth apart from the use of resources, these are the two direct goals that have been defined, but they cannot be achieved by Europe acting on its own. The document introduces inclusive growth into sustainability objectives through collaboration with its neighbouring countries.

Climate neutrality requires smart infrastructure for integrating renewables, energy efficiency and other sustainable solutions to help achieve decarbonization at minimal cost. Since significant amounts of energy and mineral supplies are necessary during the processes of building and renovating, they are to be executed in an energy-efficient way. As said before, buildings consume a considerable amount of total energy produced, and the rate of renovations of the building stock in the European Union is between 0.4 and 1.2%, so it needs to be at least doubled to reach planned targets. However, since around 50.000.000 consumers struggle financially, maintaining their homes at an appropriate level requires tackling energy efficiency and affordability at the same time. The "renovation wave" of public and private buildings, primarily schools, hospitals, and social housing, brings focus on these issues. Reducing bills and, consequently, energy poverty, are expected outcomes along with enhancing local entrepreneurship and the building sector. Simultaneous implementation of regulations on energy performance, national strategies for renovation, and regulations on construction products are to guarantee that the ever-improving building stock management respects the notion of circular economy.

Sustainability of contemporary industries, smart mobility, food supply systems, preservation and restoration of ecosystems and biodiversity, as well as reducing pollution, are also reviewed in the document. All the needed changes require research, innovation, and education, along with financing possibilities. The document announces the coming of "The Green Agenda for the Western Balkans", further cooperation with China and Africa, and also the "European Climate Pact". The overall aim is for the European Union to achieve sustainable future through a transition with equal opportunities for all.

2.5. STEPPING UP EUROPE'S 2030 CLIMATE AMBITION

In the year 2020, the European Commission adopted this document, further titled “Investing in a climate-neutral future for the benefit of our people (The 2030 Climate target plan)” [12], in order to clarify the setting of the aim of climate neutrality by 2050 and discusses possible new aspects for its achievement.

According to the document, the whole energy system is aimed to be transformed – transport, industry, and the building sector. Since 75% of the EU building stock is still inefficient in terms of energy and heating with fossil fuels is common, the renovation has great potential, but its current rates are to be increased at least two-fold by 2030. Due to need for improving building envelope, smart systems, and integration of renewables, “deep renovations” are most advised.

2.6. A RENOVATION WAVE FOR EUROPE

This document [13], adopted by the European Commission in 2020, focuses on renovations as one of the key strategies for achieving climate neutrality. It repeats the findings from previous documents regarding current state of the building stock in terms of not meeting minimal energy efficiency requirements and their responsibility for the overall energy use. It asserts that the overall renovation rate of 11% in the EU does not involve energy performance improvements, which is estimated only at around 1%. The renovations that actually reduce energy consumption by over 60%, “deep renovations”, take up to only about 0.2% of the building stock per year. They are much needed in order to reduce the stress on greenfield building, help preserve nature, biodiversity, and agricultural land.

Energy efficiency remains the primary principle, along with affordability, decarbonization and integration of renewables, circularity, health and environmental protection, green and digital transition, as well as the respect for aesthetics and quality of design. Existing regulations are to establish the minimal requirements, and effective targeted investments are to be determined. There are three particular areas in focus of said renovations: worst-performing buildings, public buildings, HVAC and water heating systems.

The document also announces "Long-term Renovation Strategy", which is to provide assessment for implementing general decarbonization of the building stock planned until 2050.

2.7. AN ECONOMIC AND INVESTMENT PLAN FOR THE WESTERN BALKANS

Adopted in 2020 by the European Commission, the document [6] firstly acknowledges the importance of the Western Balkans to the European Union and thereby transmits its “European Green Deal” recommendations to neighbouring countries, along with the help from the EU through planned investments and support. The aim is to encourage forming of a single regional market in order to bring it closer to the market of the European Union by implementing much needed reforms, which would enable fostering a long-term recovery. Green and digital transitions thus would eventually lead to sustainable economic growth.

The Annex [14] primarily examines roads, renewable energy, transition to green energy sources as investment priorities for the dual "green" and digital transition in the Western Balkans. The building sector of the Western Balkans accounts for over 40% of consumption in total energy produced as well, so the Renovation Wave remains just as important as it is within the EU, and its principles remain the same. The renovation of buildings with meeting the minimum requirements of energy performances will contribute to improving both human health and their living standards.

3. ENERGY EFFICIENCY WITHIN THE REGULATIONS OF THE REPUBLIC OF SERBIA

The subject of energy efficiency in the sector of architecture and construction is recognized in the legislation of the Republic of Serbia in two ways, as directives and goals – a part of national development and specialized sector strategies, and as mandatory laws and standards. Most national strategies [15, 16, 17] refer directly to international [3, 7, 11] and European [10] documentation. This need for harmonization is visible within the constant updating of laws and standardization. Further in this chapter reviews of the existing Serbian legislation regarding the matter are presented.

3.1. REPUBLIC OF SERBIA'S NATIONAL STRATEGY FOR SUSTAINABLE DEVELOPMENT

This document [16], adopted in 2005, and amended in 2007 by the Serbian Government, was eventually replaced by a more recent document, but it was important for this research due to the fact that it marks the beginnings of identifying the concept of sustainable development in Serbia officially, which subsequently became a broader setting for the energy efficiency notion, that is of current interest. Sustainable development principles and priorities are introduced into Serbian regulations primarily through this Strategy. Sustainability demands all-level, interdepartmental harmonization on different development aspects, since it is a long-term process affecting all life aspects. The economy, socio-economic conditions, environmental protection, and conservation of natural resources are primarily considered. In practical sense, institutional framework, sources of funding, and methods for performance monitoring are thereby defined.

Interventions that would halt the deterioration of the housing stock and enable better quality of housing conditions are cleaner technologies, increased energy efficiency, renewable energy resources, also directly reducing environmental pollution. The greatest single potential recognized is reducing the use of thermal energy for heating of housing by improving their thermal insulation. Due to economic and technological factors, energy efficiency is low, and energy is largely wasted regardless of the energy deficiency. Resulting resource depletion is one of the biggest environmental problems.

Disappointingly, the document excludes the building sector both from its Scheme of the institutional framework as an actor for its implementation, and from the institutions - indicators for monitoring, despite its identification as of great influence on the environment and high potential for improvement by all relevant documents.

3.2. SUSTAINABLE URBAN DEVELOPMENT STRATEGY UNTIL 2030

Leaning on the New Urban Agenda [7] and in accordance with a large number of EU strategies, in 2019 the Government of the Republic of Serbia adopted a new national Strategy [15] that deals with the issue of sustainability, Goal 11 - sustainable cities and communities in particular.

The main cause of low energy efficiency is the application of regulations, standards, and mandatory energy studies only on new buildings, while the vast majority of the building stock consists of buildings built before regulations became stricter in 2012. Also, a large number of buildings already built illegally in Serbia represent a huge problem, as well as the acting mechanism of their legalization. In that procedure, a reduced volume of documentation is prescribed in relation to new construction - the obligation to apply the minimal conditions of energy efficiency and the preparation of the Energy Efficiency Study is disregarded. Generally, a problem is recognized – an excessive complexity of procedures and regulations obstructs achieving the goal.

The document proposes incentive programs to improve energy efficiency in the existing building stock. Great potential for the development of cities by revitalizing brownfield sites and recycling the existing architectural heritage has been noticed. The need to use the existing urban capital can be met through the improvement, adaptation, or conversion of the existing, in order to reduce the pressure on greenfield sites.

One of the important purposes of the strategy is the creation of a strategic framework that includes the participation of stakeholders in solving key problems and identifying areas of urban development.

3.3. ENERGY DEVELOPMENT STRATEGY UNTIL 2025

Although energy efficiency is not the focus of this Strategy [17], the document adopted by the National Assembly of the Republic of Serbia in 2015 is analysed based on the fact that it states that improving its aspects within buildings can reduce the pressure on the energy sector significantly. The data within the Strategy point out that the full application of energy efficiency measures to the housing stock has the potential to save 16% of final energy consumption. This strategy also recognizes the economic potential that the improvement of energy efficiency of the existing building stock could achieve through opening of a market aimed at rehabilitation of these buildings. As in most strategic documents, the important role of further harmonization of existing regulations and standards with those applied in the EU has been recognized.

3.4. LAW ON PLANNING AND CONSTRUCTION

This is the fundamental mandatory legislation in the Republic of Serbia, regarding all planning and construction adopted in 2009, amended in 2010, 2011, 2012, 2013, 2014, 2018, 2019, 2020, and finally in 2021 [18]. The Law regulates particulars relating to planning, design, construction of buildings, terms for issuing professional licenses, determines responsibilities, supervision, and penalties in the field of building construction in Serbia.

The principle of sustainable development through integrated planning is recognized as one of the basic principles for organizing and using space. It is interpreted as harmonization of all development aspects, rational use of non-renewable resources and providing larger use of renewable ones. By applying technical measures, standards, and requirements during all stages of planning, design, construction and use of structures and spaces, sustainable construction is ensured. It is recognized that energy savings are made by reducing the consumption of all types of energy with proper management of buildings' energy properties.

3.5. RULEBOOK ON ENERGY EFFICIENCY OF BUILDINGS

Adopted in 2011 on the basis of Serbian standards previously in force, as well as European recommendations, this particular Rulebook [19] specifies technical requirements and parameters related to the energy properties of buildings, new and existing, as well as their comfort conditions. It includes the method for calculating thermal properties, using defined terms and their determined values to calculate all aspects of energy properties and consumption. An energy efficient building is defined as "a building that consumes a minimum amount of energy while providing the necessary comfort conditions". An Energy Efficiency Study is stated as an obligatory part of documentation for building, and the Energy Passport displays the energy properties of the building after the inspection finishes.

Energy rehabilitation is introduced in order to increase the energy efficiency of buildings. It is defined as a process that does not affect the stability and safety, does not affect fire and environmental protection, and, with obtaining the necessary approvals can allow for alterations to the building's external appearance.

Extensive renovation is defined as adapting or rehabilitating with an estimate of the value of works of at least 25% of the price of the building with land, or if the envelope is subjected to energy rehabilitation in at least 25% of its surface.

Energy properties of buildings are specified in this document: comfort conditions, hygrothermal properties, thermal properties and air tightness properties, heat losses, thermomechanical systems, central heating systems, mechanical air preparations, hot water distribution networks, etc. It also gives instructions on thermal properties calculations, Energy Efficiency Studies and its contents, CO₂ emissions, and more.

3.6. RULEBOOK ON THE CERTIFICATE ON ENERGY PERFORMANCE OF BUILDINGS

This is a more recent document from 2018 that is focused on detailed conditions, content, and means of issuing Certificates on Energy Performance of Buildings which is issued after inspecting the building in order to obtain a Use Permit. [20]

A standardized form of energy passport contains indicators of energy performance of buildings that utilizes the concept of energy classes for all structures that use energy. It is mandatory for all new structures, with noted exemptions. "C" or higher class is obligatory for new buildings, whereas all the improvements proposed for existing structures need an increase of one class minimum.

3.7. STANDARD FOR CONSERVATION OF CULTURAL HERITAGE

European Standard from 2016, a non-mandatory document fully titled "Conservation of cultural heritage - Guidelines for improving the energy performance of historic buildings" [21], arose from the need to adopt appropriate procedures as an addition to the existing energy performance standards, considering values that these structures possess as cultural heritage. In order to reach the optimal solution and selection of appropriate measures for each individual case, a systematic approach is used to form an assessment of the impact of selected measures, which are invariably in accordance with heritage charters, standards, and guidelines in force.

Architectural and conservation planning are executed along with energy performance assessments, evaluations of technical systems, internal and external conditions, financial considerations, as well as evaluating the heritage and considering practical application of selected measures. The process is iterative in order to review needs for improving energy performance, potentials, and limitations.

Inappropriate measures are eliminated until satisfactory measures are determined. One of the possible outcomes can even be the exclusion of any measures recommended for a particular case.

The document introduces checklists for assessing the appropriate categories and criteria for potential measures, and the basic matrix of the iterative process. Detailed recording of all phases is needed for creating a valid assessment, as well as for future use of knowledge already gained. Additional supervision is needed due to increased possibility of unforeseen circumstances while implementing selected measures. After the execution, proper evaluation is performed in order to ensure the realization of objectives previously set.

4. DISCUSSION AND CONCLUSION

The depletion of energy sources and crisis during the previous century were merely a symptom of environmental decay due to an era of intense industrialization based on extensive use of resources which were used as a measure of economic success. However, the energy sector possesses the most potential to aid the remedy of our planet, if taken care of promptly and properly, with substantial decrease in energy needs. Energy efficiency thus becomes a global effort. It is the most prominent aspect of potential for energy savings regarding architecture and construction, which are proved to have a large impact on the consumption of energy in total. It is suitable both for new construction and existing building stock, being an immediate strategy for improvement.

Energy efficiency legislatives that have a direct impact on Serbia's national policies include European directives and regulations. In accordance with the hierarchy of competencies and the principle of legality, these are incorporated in national strategies and further, harmonized with the regulations of the Republic of Serbia, as their signatory. Laws and regulations thus provide a legal framework for the implementation of European Union requirements and recommendations in practice.

Current principles of saving energy resources in construction, prescribed by the European Union through directives primarily dealing with energy efficiency, transferred to us through national strategies, the Law on Planning and Construction and Regulations on Energy Efficiency and Energy Performance of Buildings, are given in a way that enables their direct application to new construction and, to a certain degree, to the existing building stock. Unfortunately, the problem remains that they still have not made a significant overall impact on the improvement of the building sector, and it prevented the realization of larger effects. Identifying the causes for low implementation of existing strategical documents represents a considerable possibility for future research. As higher levels of legislations, such as UN or EU documents, are quite broad, lower levels and narrower perspectives are to provide better operationalization, so the key regulatory framework for the implementation might be found on regional and national level. Some issues can already be addressed, regarding national particulars.

There is a noticeable lack of overall estimation of the number and extent of improvements needed in Serbia, due to practical reasons of older building stock data deficiency and illegal construction still present and uncharted. Further steps for ensuring better outcomes on the matter would have to encompass estimations for establishing national annual rates for building stock renovations. Also, in terms of public financing for energy efficiency improvements, relatively small funds are provided for enhancing building envelope and window replacements for a limited number of private owners, while the public buildings have means of securing more funding through public procurements. This is closely related to the overall procedure of accession to the European Union and chapters closed until certain progress is made. In order to further operationalize existing regulations for energy efficiency implementation, there should be an effort made to develop national implementation strategies and action plans, as found in the Economic and Investment plan for the Western Balkans. The obligation of performing complex procedures for achieving energy efficiency in construction is currently highly emphasized through the regulations of the Republic of Serbia, while the many benefits for health, environment, comfort levels, or even reduced monthly bills are not advertised enough through planned activities in order to promote the concept. As a result, the average member of the general public in Serbia understands this primarily as a mandatory financial expense during construction one should try to avoid, and not as a means of enhancing the quality of their life and health, nor a contribution of science and research progress on the matter.

In practice, we recognize an ultimate need for educating the public and promoting the concept of energy efficiency, while ensuring stricter permit issuing and supervision over the execution of works. In addition, more substantial funding, clearer goals, and procedures for implementation, especially for building stock that was built prior to 2012, would not only help dealing with energy

poverty, but also ensure better health standards and life quality for individuals, as well as environmental benefits and energy supply security for the Republic of Serbia.

LITERATURE

- [1] Giuliano, "Western Europe and the Long Energy Crisis of the 1970s," in *Europe in a Globalizing World: Global Challenges and European Responses in the "long"*, Europe, Nomos, 2014, p. 147 – 164.
- [2] Alliance Commission on National Energy Efficiency Policy, "The History of Energy Efficiency," January 2013. [Online]. Available: https://www.ase.org/sites/ase.org/files/resources/Media%20browser/ee_commission_history_report_2-1-13.pdf.
- [3] W. C. o. E. a. D. (WCED), „Our common future,“ Oxford University Press, World, Oxford, 1987.
- [4] United Nations Environment Programme, Global Status Report for Buildings and Construction: Towards a Zero-emission, Efficient and Resilient Buildings and Construction Sector, Nairobi: United Nations Environment Programme, 2021.
- [5] E. Union, „DIRECTIVE 2010/31/EU OF THE EUROPEAN PARLIAMENT AND OF THE COUNCIL of 19 May 2010 on the energy performance of buildings (recast),“ *Official Journal of the European Union*, pp. 153/13-35, 18 6 2010.
- [6] European Commission, „S An Economic and Investment Plan for the Western Balkans,“ 2020. [На мрежи]. Available: https://ec.europa.eu/neighbourhood-enlargement/system/files/2020-10/communication_on_wb_economic_and_investment_plan_october_2020_en.pdf. [Последњи приступ 2021].
- [7] United Nations, „New Urban Agenda,“ Habitat III Secretariat, World, 2017.
- [8] European Union, „DIRECTIVE 2012/27/EU OF THE EUROPEAN PARLIAMENT AND OF THE COUNCIL of 25 October 2012 on energy efficiency, amending Directives 2009/125/EC and 2010/30/EU and repealing Directives 2004/8/EC and 2006/32/EC,“ *Official Journal of the European Union*, pp. 315/1-56, 14 11 2012.
- [9] European Union, „DIRECTIVE (EU) 2018/844 OF THE EUROPEAN PARLIAMENT AND OF THE COUNCIL of 30 May 2018 amending Directive 2010/31/EU on the energy performance of buildings and Directive 2012/27/EU on energy efficiency,“ *Official Journal of the European Union*, pp. 156/75-91, 16 6 2018.
- [10] European Commission, „Green Deal,“ 2019. [На мрежи]. Available: <https://eur-lex.europa.eu/legal-content/EN/TXT/?qid=1596443911913&uri=CELEX:52019DC0640#document2>. [Последњи приступ 2021].
- [11] United Nations, „Paris Agreement,“ у *Conference of Parties (COP) Framework Convention on Climate Change (UNFCCC)*, Paris, 2015.
- [12] European Commission, „Stepping up Europe’s 2030 climate ambition Investing in a climate-neutral future for the benefit of our people,“ 2020. [На мрежи]. Available: <https://eur-lex.europa.eu/legal-content/EN/TXT/?uri=COM:2020:562:FIN>. [Последњи приступ 2021].
- [13] European Commission, „A Renovation Wave for Europe - greening our buildings, creating jobs, improving lives,“ 2020. [На мрежи]. Available: https://ec.europa.eu/commission/presscorner/detail/en/IP_20_1835. [Последњи приступ 2021].
- [14] European Commission, „An Annex Economic and Investment Plan for the Western Balkans,“ 2020. [На мрежи]. Available: https://ec.europa.eu/neighbourhood-enlargement/system/files/2020-10/communication_on_wb_economic_and_investment_plan_october_2020_en.pdf. [Последњи приступ 2021].
- [15] Република Србија, „Стратегија одрживог урбаног развоја Републике Србије до 2030 године,“ *Службени гласник РС*, т. 47, 2019.
- [16] Република Србија, „НАЦИОНАЛНА СТРАТЕГИЈА ОДРЖИВОГ РАЗВОЈА,“ *Службени гласник РС*, т. 55/05, бр. 71/05-исправка и 101/07, 2017.
- [17] Република Србија, „Стратегија развоја енергетике Републике Србије до 2025. године са пројекцијама до 2030. године,“ *Службени гласник РС*, т. 101, 2015.
- [18] Република Србија, „Закон о планирању и изградњи,“ *Службени гласник РС*, Том. %1 од %272/2009, 81/2009 - испр., 64/2010 – одлука УС, 24/2011, 121/2012, 42/2013

- Одлука УС,50/2013 – одлука УС, 98/2013 – одлука УС, 132/2014, 145/2014, 83/2018, 31/2019, 37/2019 –др. закон, 9/2020 і 52/2021, 2021.
- [19] Република Србија, „ Правилник о енергетској ефикасности објеката,“ *Службени гласник РС*, т. 61, 2011.
- [20] Република Србија, „Правилник о условима, садржини и начину издавања сертификата о енергетским својствима зграда,“ *Службени гласник РС*, Том. %1 од %2 69/2012 - 44/2018, 2018.
- [21] European Standard, „Conservation of cultural heritage - Guidelines for improving the energy performance of historic buildings,“ 2016. [На мрежи]. Available: <https://www.en-standard.eu/csn-en-16883-conservation-of-cultural-heritage-guidelines-for-improving-the-energy-performance-of-historic-buildings/>. [Последњи приступ 2021].



Jelena Rašović, University of Banja Luka, jelena.rasovic@aggf.unibl.org

Biljana Antunović, University of Banja Luka, biljana.antunovic@aggf.unibl.org

RADON SOURCES AND ACTION LEVELS

Abstract

Radon is by far the largest contributor to population exposure because the dose received from radon and its progeny exceeds all other radiation sources. After smoking, it is the second most frequent cause of the lung cancer, therefore it is classified as Group 1 carcinogenic to humans. The soil under a building is the major source of indoor radon. An important contribution to indoor radon concentration comes from building materials whose composition includes volcano rocks as well as household water. The aim of this paper is to present a brief overview of indoor radon sources and prescribed permitted concentration levels in Bosnia and Herzegovina and the world. Finally, the hazardous effects on human health have been discussed.

Keywords: radon, exposure, soil, building materials, water, lung cancer risk

ИЗВОРИ РАДОНА И АКЦИОНИ НИВОИ

Сажетак

Радон је елемент који далеко највише доприноси изложености становништва јер доза примљена од радона и његових продуката превазилази све друге изворе зрачења. Послије пушења, радон је најчешћи узрочник рака плућа због чега је сврстан у прву категорију канцерогена за људе. Главни извор радона у унутрашњем простору је земљиште испод зграде. Значајан допринос концентрацији радона у унутрашњости потиче од грађевинских материјала у чији састав улазе вулканске стијене и воде за домаћинство. Циљ овога рада јесте преглед извора радона у унутрашњем простору и дозвољених концентрација радона у Босни и Херцеговини и свијету. На крају су размотрени штетни ефекти по здравље људи.

Кључне ријечи: радон, излагање, земљиште, грађевински материјали, вода, ризик од рака плућа

1. INTRODUCTION

Naturally occurring radioactive elements are spontaneously disintegrated in the process of radioactive decay, after which a nucleus with different properties is formed and the process is accompanied by the emission of the alpha particles, beta particles, or gamma rays. Most of the natural radioactive isotopes that contribute to the dose received by humans are members of one of the three radioactive decay chains (uranium ^{238}U chain, thorium ^{232}Th chain, and uranium ^{235}U chain), [1]. The most important non-chain radionuclides that contribute to human exposure are potassium ^{40}K and rubidium ^{87}Rb [1].

The decay chain of the uranium 238 contains radium as one of the members of its series (Figure 1). By ^{226}Ra alpha particle emission natural, noble gas radon is formed and released into the atmosphere. Radon is colorless and odorless gas without taste, chemically inert and radioactive, and cannot be detected by any single sense but an appropriate detection system. Under normal conditions it is gaseous, easily inhaled, and one of the densest gases at room temperature. All of the radon isotopes, radon (^{222}Rn), thoron (^{220}Rn), and acton (^{219}Rn), are radioactive and formed as a result of the uranium, thorium, or actinium decay series. Since it has the longest half-life of 3.8232 days [2], the most significant among them is ^{222}Rn , a member of the ^{238}U decay series. The half-life for the thoron (^{220}Rn) and acton (^{219}Rn) is 55.6 s and 3.96 respectively, thus their impact on population exposure is negligible.

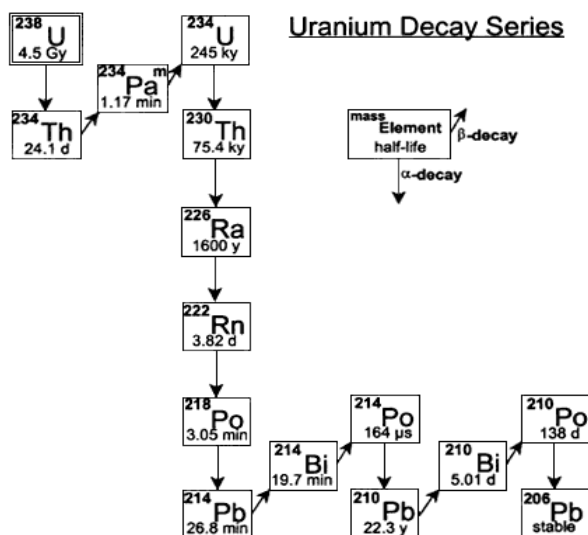

Figure 1. Uranium 238 decay series [2].

Radon is the most significant natural source of ionizing radiation because it has been disintegrated into radioactive, short-lived alpha particles emitter: bismuth, polonium, and plumb. The biological effects of radiation in a certain medium are described by the equivalent dose. Since the equivalent dose for the alpha particles is higher than for the other ionizing radiation (radiation weighting factor is 20 times higher than for gamma and X-rays), alpha particles produce greater biological harm than do beta particles and gamma rays. Passing through the biological structures, ionizing alpha particles can cause irreparable damage to DNK or produce chemically active free radicals.

According to UNSCEAR (2008) annual global average dose received by humans from natural sources is 2.4 mSv (80%) while humans on average receive 0.6 mSv (20%) from artificial sources. It can be seen in Figure 2 that the average dose due to exposure to radon is 1.26 mSv. Dose from radon and its decay products for the average person exceeds all other sources together: radon and its progenies, mostly ^{218}Po and ^{214}Pb , contribute about 50% to the total annual dose from the natural sources [3]. While alpha particles and radon may lead to internal exposure, external exposure occurs due to the emission of gamma rays produced in the decay chains or in ^{40}K decay process.

Uranium and radium naturally occur in soils, rocks, and groundwater. As a result of mixing with human-inhaled air or drinking-water radon can enter the human body. Radon has been classified by International Agency for Research on Cancer (IARC) as Group 1, carcinogenic to humans [4]. After smoking, it is the second most important cause of lung cancer in many countries, while the probability of cancer rises relative to smoking habits [3] because the process of attaching decay products to the atmospheric particles is more pronounced in the smoking rooms regarding nonsmoking.

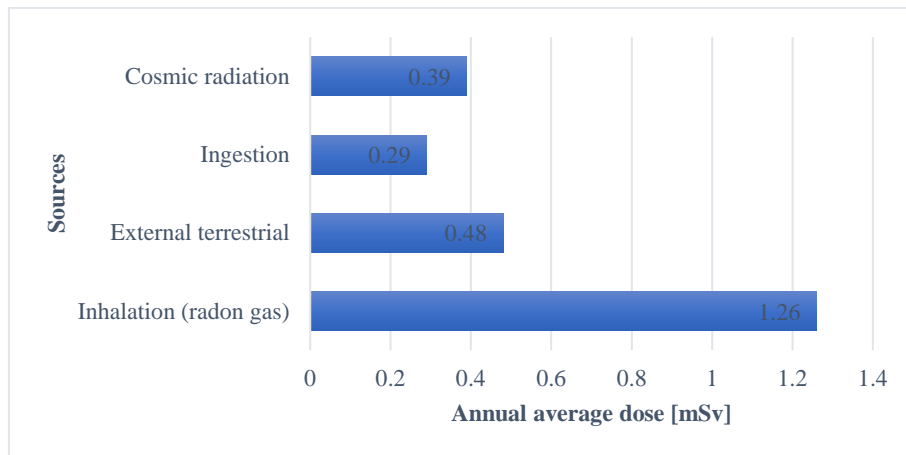

Figure 2. Radiation sources and their contribution to the annual average dose.

Nowadays, radon levels in the interior spaces have been evaluated in most countries, parameters that affect concentration have been analyzed as well as procedures that should have to be taken in order to reduce the level below prescribed values.

2. RADON INSIDE OF BUILDINGS

The term Indoor Air Quality (IAQ) is used to refer the air quality inside of building depending on concentration of the pollutants and thermal conditions that affect a health, comfort and performances of inhabitants in all types of buildings. One of the most significantly indoor air contaminants is radon. Long term exposure to radon and other hazardous substances in air results in some chronic effects, most notably lung cancer. As noted early, radon can enter house moving up from the ground soil and rocks, from building materials and from ground water. According to UNSCEAR soil contribute about 80% to indoor radon concentration, building materials with 12%, while the rest is from the water and air from the outside [5].

2.1. SOIL UNDER A BUILDING

Concentration of the uranium/radium in the soil under a building is determined by concentration of these elements in the rocks from which the soil was formed. Soil is considered as the main source of indoor radon concentration.

Radon formation and pathways to the air include processes of emanation, transport and exhalation [2]. Emanation is defined as the process of radon releasing the grain that contains ^{226}Ra and escapes into the interstitial space between the grains when radium decays [2]. After that, radon atoms can be moved through the process of diffusion or convective fluid flow before reaching the surface. Exhalation represents releasing gas into the atmosphere from the ground surface.

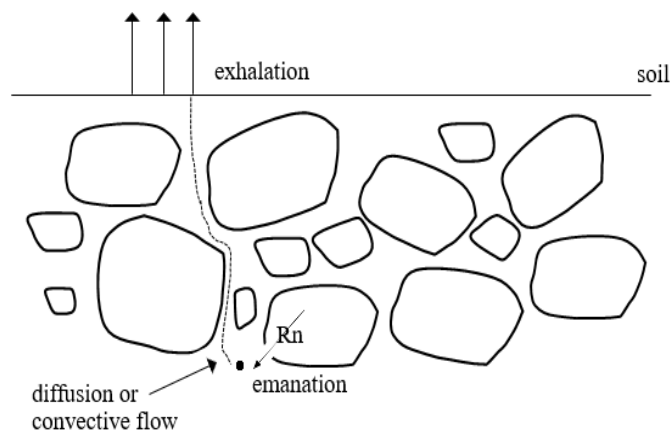

Figure 3. Process of radon transport in the soil.

Temperature difference between the air inside a building and the air outside creates the pressure difference in the way that the air pressure inside is usually lower than the pressure in the soil around the foundations and basements floor slab. The existence of the air pressure difference leads to the process of convective fluid flow. The pressure differences of the air inside and outside of the building can also be affected by wind [6]. The quantity that represents the ability of a material to acts as a barrier to gas movement through it when pressure gradient exists is named permeability.

The existence of the radon concentration differences between low-concentration regions, such as the interior of the building, and higher-concentration area of the soil or building materials, causes the process of diffusion throughout which the radon atoms are moved in the direction opposite of concentration increasing gradient, from the place of higher radon concentration to the lower concentration place [6]. Furthermore, the diffusion is dominant transport mechanism process so the convective component of radon transport usually is not considered [2, 7]. The value of radon diffusion coefficient for materials represents the ability of gas movement through the material when concentration gradient exists and it is proportional to permeability.

Regarding capability to act as a protection from radon, the diffusion coefficient, diffusion length, and thickness of different materials are generally determined, although in some cases the permeability coefficient is also calculated.

The amount of radon gas that reaches the interior depends on the diffusivity of the substructure and permeability of soil [6, 8]. As a result, higher radon concentrations can be found in buildings without basements [9]. To ensure reliable protection, the thickness of insulating material on the ground floor must satisfy the following condition [10]:

$$d \geq 3l \quad (1)$$

where d (m) is the thickness of the material, while l (m) represents radon diffusion length in the material and can be calculated as:

$$l = \sqrt{\frac{D}{\lambda}} \quad (2)$$

D (m²/s) is radon diffusion coefficient and λ (1/s) is radon decay constant. Diffusion length primarily depends on the material species. According to some new research, condition (1) is too strict and only a small number of waterproofing materials can satisfy this condition (less than 5.5%) despite the fact that they represent a good protection [11]. Instead condition (1), it is more relevant to calculate the radon resistance value for each material and use an approach that is based on exponential radon distribution in the sample [11].

Relation between thickness and material permeability is given through the equation [12]:

$$k = Pd \quad (3)$$

k is permeability coefficient (m²/s), P is transmittance or the speed of radon flow (m/s). For the lower, medium and high values of diffusion length materials are marked as radon-tight, radon less permeable and radon permeable.

Materials that are homogeneous are likely to have lower permeability coefficient, while heterogeneity indicates higher value of permeability and diffusion coefficient. According to some researches [12] insulating materials such as foil thermo-vapor barrier, the insulation film under the foundation are found to be the best protection against soil radon gas. In this way, installing good waterproofing materials provides building protection from radon.

Problems with determining and comparing materials permeability/diffusion coefficient in different countries are caused by non-establishing unique experimental procedures which may lead to several orders of magnitude value variability for the same material. The new ISO/TS 11665-13 (2017) standard may lead to the improvement in this field [11].

2.2. BUILDING MATERIALS

Building materials used for construction like concrete, brick, cement, sand, and gravel may have increased concentrations of ²²⁶Ra, ²³²Th, as well as ⁴⁰K, and they are usually denoted as naturally occurring radioactive materials or NORM. These elements reflect the geology of the places from which raw materials are taken. Despite the fact that the soil under a building is considered as the main source of radon in closed space, in some of the building materials made from granite, slate, or volcano rocks, the content of radionuclides is higher than in soils [13]. The high content of radionuclides can pose a risk not only because of radon but also from gamma radiation, particularly on the upper floor where contribution to exposure from building material is dominant.

In order to estimate building material's hazardous effects, especially since it is well known that individuals spent an average of 80% of their time indoors, activity concentrations, radium equivalent activity index, gamma index, absorbed dose, and annual effective dose from ^{236}Ra , ^{232}Th , and ^{40}K have been determined in the number of papers [7, 14, 15, 16]. Many studies reported that standardly used materials are safe for construction because obtained values are within permitted limits. Worldwide activity concentrations of these radionuclides in building materials are 50 Bq/kg 50 Bq/kg and 500 Bq/kg respectively. Some of the research indicate that granite and siporex are not recommended in poorly ventilated rooms [7].

Radium equivalent activity index allows comparing measured activity concentrations of radionuclides since materials have different concentration of them and its recommended maximum value is 370 Bq/kg [17]. Gama index, the quantity that takes into account the different exposure contributions of different elements, should be less than 1 for bulk materials and less than 6 for superficial material, in which case annual effective dose from exposure to gamma radiation from radionuclides in building materials will be less than 1 mSv.

Radionuclide activity concentrations analysis of building materials used in Bosnia and Herzegovina has shown that values of all quantities are below prescribed standards [15]. Generally, in Bosnia and Herzegovina, insufficient attention is paid to the issue of materials radioactivity and only a few studies have been done. Also, a legal framework for radon protection, which is in the process of extension and improvement, does not clearly define the activities which could involve NORM [18] and only provide concentration limits (Table 1) for the three radionuclides depending on indoor and outdoor usage of building material in architectural engineering.

Table 1. Concentration limits for indoor and outdoor building materials in BiH [19].

Radionuclide	Indoor concentration limit (Bq/kg)	Outdoor concentration limit (Bq/kg)
^{226}Ra	300	400
^{232}Th	200	300
^{40}K	3000	5000

2.3. RADON IN WATER

Household water as the need for life may be used either from the surface or ground. Like building materials and soil, water contains dissolved naturally occurring radioactive elements: uranium, thorium, and actinium. Radon from water poses a danger to humans in two ways: it may be released into indoor air and attached aerosol, or can be ingested into the body through consumption which passes through the wall of the stomach. If the water comes from a surface water source, then most of the radon will be released into the atmosphere before reaching supply or home. Concerns about radon may be in the case if the underground water is used directly from the place of its origin. Underground water is moved through rocks and materials containing uranium (radium) contributing to high concentration of radionuclides in water. The concentration may be especially increased in volcanically active areas.

According to Environmental Protection Agency for drinking water (EPA), radon concentration level in water that shouldn't be exceeded is 11.1 Bq/l, while WHO has a restricted level to 100 Bq/l which corresponds to annual effective dose of 0.1 mSv/y [20, 21]. Despite the fact that this country still doesn't have established regulations regarding radon levels in drinking water, in Bosnia and Herzegovina analysis has been performed for drinking water in the Tuzla area. Obtained results indicate that the radon activity concentration has not exceeded the value of 100 Bq/l [22].

Higher risk from radon in water occurs in places with thermal and mineral water spa, where the radon rich water has been used for therapeutic purposes. In spa areas, elevated radon concentrations are found both, indoor and outdoor. One such example is Niška Banja spa in Serbia, which represents an area of high activity due to the specific geology. Activity concentrations in some water samples were from 24.5 ± 2.4 Bq/l to 648 ± 38 Bq/l which exceeded EPA recommendation as well as WHO upper level [23] while high concentrations were also measured in hotel spas and houses. Measurements of radon activity concentrations in spas of B&H had shown that prescribed levels were not exceeded and all concentrations were below 11.1 Bq/l [24].

2.4. PARAMETERS THAT AFFECT RADON LEVEL

Apart from geology and building materials characteristic, it should be noted that radon level concentrations is influenced by several other parameters: ventilation, temperature, humidity,

pressure, seasons. Dwellings that are closed all day or during the weekend are expected to have higher average radon concentrations than if the same dwelling were well ventilated all the time.

A number of studies have shown the impact of temperature on radon concentration variation. In the winter period, the outdoor temperature is significantly lower than indoor temperature leading to higher outdoor pressure. This temperature ratio impacts the pressure difference and causes gas flow and infiltration to indoors. This effect is enhanced during the winter, while reverse flow may occur in the summer [25]. As a result, a radon level variation during the seasons was observed.

A study in China has shown the impact of rain on radon concentration. As it was suggested, a lower concentration during the rainy day was influenced by lower outdoor pressure, humidity and soil moisture that had limited pathways [26].

Due to the number of influencing parameters, it is advisable performing measurements for one year on all ground premises.

3. RECOMMENDED RADON LEVELS

3.1. INDOOR RADON LEVEL

A recommended level or action level represents annual average radon activity concentration above which it is necessary to conduct measure in order to reduce radon concentration. By the World Health Organization, annual average indoor radon concentration reference level is 100 Bq/m^3 ; if this level cannot be reached, then the chosen reference level should not exceed 300 Bq/m^3 [3]. International Commission on Radiological Protection (ICRP) has recommended reference level of 300 Bq/m^3 for homes and workplaces.

Countries in the region have different national reference levels. In Serbia, the national reference level for indoor radon concentration for new buildings is 200 Bq/m^3 , for the existing buildings is 400 Bq/m^3 , while 1000 Bq/m^3 is the upper level recommended for workplaces. A new national radon survey has shown that in 3% of all measurements the level of 400 Bq/m^3 has been exceeded [27]. The required annual average radon activity concentrations which represent upper limit in Montenegro currently have the same values as in Serbia. As a candidate to EU membership, in both countries, the required action level is 300 Bq/m^3 . This level is defined for homes and workplaces according to the EU directive from 2013 [28]. Croatia has also defined an action level of 300 Bq/m^3 according to the EU directive.

Determination of radon concentration for the whole territory in Bosnia and Herzegovina has not been completed yet and only local surveys were performed. An old regulation prescribed an action level of 1000 Bq/m^3 for workplaces. State regulatory agency for radiation and nuclear safety works on new regulation that will include the new reference level (probably 300 Bq/m^3 , in order to unify with some countries of the region and the European Union), monitoring radioactivity, as well as new legal framework for NORM [18].

The indoor radon measurements are generally performed in dwellings, while kindergartens and schools are sometimes chosen as location. The first investigation on the indoor radon and thoron and their decay products concentration in 25 primary schools of Banja Luka was performed from May 2011 to April 2012. The obtained geometric mean concentrations were 99 Bq/m^3 and 51 Bq/m^3 for radon and thoron gases respectively [29]. A new study on radon concentration in the school indicates a high spatial variability of radon concentration so it was recommended to measure it in all ground level rooms [30].

3.2. OUTDOOR RADON LEVEL

The average outdoor radon level is usually low, less than 100 Bq/m^3 and does not represent a risk to the population because it gets diluted. Outdoor radon activity concentration in B&H was measured at 92 locations and mean activity concentrations were in range of 15 to 38 Bq/m^3 [31]. Elevated activity concentrations in some areas were conditioned by the technological processing of coal and raw material.

4. CANCER RISK

Radon progenies attached to the aerosols might enter the lungs by breathing, deposit on lung epithelial and increase the risk of lung cancer. From the respiratory tract, these particles may be transported to the gastrointestinal tract, to lymph nodes, or transferred by fluid (blood and lymph) to other tissues. Water ingesting is another way to enter and circulate through the body. Radon ingested by water enters the stomach from where it can enter the bloodstream.

Ionizing alpha particles emitted by deposited short-lived decay products of radon (^{218}Po and ^{214}Po) can interact with biological tissues and deliver large localized radiation doses. Even a single alpha particle can cause major genetic damage to a cell. Depending on the average radon concentration, the percentage of all lung cancers related to radon is estimated to be in the range of 3% to 14% while long-term exposure to radon concentration that is increased by 100 Bq/m^3 increases lung cancer risk by about 16% [3].

Relation between radon progeny concentration in the air and the risk of lung cancer was obtained in the study on lung cancer mortality among uranium miners and other coworkers exposed to very high levels of radon progeny. Radon-related increase in mortality caused by other cancer types has also been researched but clear evidence that radon cause other than lung cancer has not been found yet.

5. CONCLUSION

In this paper, an overview of radon sources, parameters that affect radon levels, risks for human health and action levels for B&H and surrounding countries have been presented. It can be concluded that radon gas present in the buildings and homes comes mainly from the soil. After the soil, radon concentration may be increased by radon contained in the building materials and water. On the other hand, outdoor radon concentration is negligibly low compared to indoor and usually does not represent a risk for human health.

As there is a clear evidence that elevated radon concentration increases the risk of developing lung cancer, it is necessary to implement the measures in order to reduce the concentration when the prescribed radon levels are exceeded.

Waterproof materials act as a barrier between the soil and indoor space (materials that have small permeability) and can be used to reduce indoor radon concentration. It is advisable to perform an adequate control and measurements, especially in dwellings and workspaces located on the ground floor and basement levels for which is expected to have a higher radon concentration. Increasing ventilation can also be used as a measure.

From the available researches, it can be concluded that prescribed radon levels and radionuclides concentrations in B&H are underestimated. However, previous researches have shown that in B&H hazardous levels of radon concentrations are not exceeded, either indoors or outdoors neither in water.

In the future, it is necessary to conduct more detailed research and establish stricter regulations and values for radon levels.

LITERATURE

- [1] National Research Council (US) Committee on Evaluation of EPA Guidelines for Exposure to Naturally Occurring Radioactive Materials, Evaluation of Guidelines for Exposures to Technologically Enhanced Naturally Occurring Radioactive Materials. Washington (DC): National Academies Press (US), 1999.
- [2] International Atomic Energy Agency (IAEA), Measurement and Calculation of Radon Releases from NORM Residues, Vienna: IAEA, 2013.
- [3] World Health Organization, WHO handbook on indoor radon: a public health perspective. Geneva: WHO, 2009.
- [4] IARC Working Group on the Evaluation of Carcinogenic Risks to Humans, Man-made Mineral Fibers and Radon. Lyon (FR): International Agency for Research on Cancer, 1988.
- [5] UNSCEAR 2000, Report to the General Assembly—Annex B Exposures from natural radiation sources. New York (USA): United Nations Publication, 2000.
- [6] National Research Council (US) Committee on Risk Assessment of Exposure to Radon in Drinking Water, Risk Assessment of Radon in Drinking Water. Washington (DC): National Academies Press (US), 1999.
- [7] P. Kuzmanovic, N. Todorovic, L. Filipovic Petrovic, D. Mrdja, S. Forkapic, J. Nikolov, J. Knezevic, "Radioactivity of building materials in Serbia and assessment of radiological hazard of gamma radiation and radon exhalation," *Journal of Radioanalytical and Nuclear Chemistry*, vol. 324, pp. 1077-1087, 2020.
- [8] I. Mäkeläinen, H. Arvela, A. Voutilainen, "Correlations between radon concentration and indoor gamma dose rate, soil permeability and dwelling substructure and ventilation," *The Science of the total environment*, vol. 272, pp. 283-289, 2001.

- [9] M. Karpińska, Z. Mnich, J. Kapała, A. Szpak, "The Evaluation of Indoor Radon Exposure in Houses," *Polish Journal of Environmental Studies*, vol. 18, no. 6, pp.1005-1012, 2009.
- [10] G. Keller, B. Hoffmann, T. Feigenspan, "Radon permeability and radon exhalation of building materials," *The Science of the total environment*, vol. 272, pp. 85-89, 2001.
- [11] M. Jiránek, V. Kačmaříková, "Radon diffusion coefficients and radon resistances of waterproofing materials available on the building market," *Journal of Environmental Radioactivity*, vol. 208-209, pp. 2019.
- [12] J. Walczak, J. Olszewski, M. Zmysłony, "Radon permeability of insulating building materials," *Nukleonika*, vol. 61, pp. 289-293, 2016.
- [13] D. Popovic, D. Todorovic "Radon indoor concentrations and activity of radionuclides in building materials in Serbia," *Facta Universitatis - series : Physics, Chemistry and Technology*. vol. 4, 2006.
- [14] M. Imani, M. Adelikhah, A. Shahrokhi, G. Azimpour, A. Yadollahi, E. Kocsis, E. Toth-Bodrogi, T. Kovács, "Natural radioactivity and radiological risks of common building materials used in Semnan Province dwellings," *Environmental science and pollution research international*, vol. 28, no. 30, pp. 41492-41503, 2021.
- [15] A. Kasumovic, E. Hankic, A. Kasic, F. Adrovic, "Natural radioactivity in some building materials and assessment of the associated radiation hazards," *Radiochimica Acta*, vol. 106, no. 1, pp. 79-86, 2018.
- [16] MJ. Madruga, C. Miró, M. Reis, L. Silva, "Radiation exposure from natural radionuclides in building materials," *Radiation protection dosimetry*, vol. 185, no. 1, pp. 49-57, 2019.
- [17] International Atomic Energy Agency (IAEA), *Protection of the Public against Exposure Indoors due to Radon and Other Natural Sources of Radiation, Specific Safety Guides*. Vienna: IAEA, 2015.
- [18] M. Isovica, "Activites on the legal framework for the protection," *Contemporary Materials*, vol. 11, no. 1, pp. 58-61.
- [19] Bosina and Herzegovina State Regulatory Agency for Radiation Safety and Nuclear Safety, "Regulation on the concentration limits for radionuclides in food, feed, medicines, items of general use, building materials, and other goods placed on the market," *Official Gazette B&H*. 54/14, 2014.
- [20] The Environmental Protection Agency, EPA protocol for the measurement of radon in homes and workplaces. EPA, 2019.
- [21] World Health Organisation (WHO), *Guidelines for drinking water quality*. 3rd ed., Geneva: WHO, 2004.
- [22] A. Kasic, A. Kasumovic, F. Adrovic, M. Hodzic, "Radon measurements in well and spring water of the Tuzla area, Bosnia and Herzegovina," *Arhiv za higijenu rada i toksikologiju*, vol. 67, no. 4, pp.332-339, 2016.
- [23] J. Nikolov, N. Todorovic, T. Petrovic Pantic, S. Forkapic, D. Mrdja, I. Bikit, M. Krmar, M. Veskovic, "Exposure to radon in the radon spa Niska Banja, Serbia," *Radiation Measurements*, vol. 47, pp. 443-450, 2012.
- [24] A. Kasic, E. Hankic, A. Kasumovic, F. Adrovic, "Levels of Radon Activity Concentration in Thermal Waters of Bosnia and Herzegovina," *Journal of Materials Science and Engineering B*, vol. 3, pp. 539-544, 2013.
- [25] J. Rey, S. Goyette, M. Gandolla, M. Palacios, F. Barazza, J. Goyette Pernot, "Long-Term Impacts of Weather Conditions on Indoor Radon Concentration Measurements in Switzerland," *Atmosphere*, vol. 13, no. 1, 2022.
- [26] D. Xie, M. Liao, H. Wang, KJ. Kearfott, "A study of diurnal and short-term variations of indoor radon concentrations at the University of Michigan, USA and their correlations with environmental factors," *Indoor and Built Environment*, vol. 26, no. 8, pp.1051-1061, 2017.
- [27] M. Eremic Savkovic, V. Udovicic, D. Maletic, G. Pantelic, P. Ujic, I. Celikovic, S. Forkapic, V. Markovic, V. Arsic, J. Ilic, B. Markoski, "Results of the first national indoor radon survey performed in Serbia," *Journal of Radiological Protection*, vol. 40, 2020.
- [28] EURATOM, 2013. Council Directive 2013/59/EURATOM of 5 December 2013. *Official Journal of the European Union*, 17.01.2014
- [29] Z. Curguz, Z. Stojanovska, ZS. Zunic, P. Kolarz, T. Ischikawa, Y. Omori, R. Mishra, B.K. Sapra, J. Vaupotic, P. Ujic, P. Bossew, "Long-term measurements of radon, thoron and their airborne progeny in 25 schools in Republic of Srpska," *Journal of Environmental Radioactivity*, vol. 148, pp.163-169, 2015.

- [30] Z. Curguz, G. Venoso, ZS. Zunic, D. Mirjanic, M. Ampollini, C. Carpentieri, C. Di Carlo, M. Caprio, D. Alavantic, P. Kolarz, Z. Stojanovska, S. Antignani, F. Bochicchio, "Spatial variability of indoor radon concentration in schools: implications on radon measurements protocols," *Radiation protection dosimetry*, vol.191, no.2, pp.133-137, 2020.
- [31] A. Damjanovic, J. Adrovic, Z. Tresnjo, F. Adrovic, "Measurements of Environmental Radon Activity," *Journal of Materials Science and Engineering A*, vol. 5, pp. 339-346, 2015



Budimir Sudimac, University of Belgrade, sudimac@arh.bg.ac.rs
Darija Gaijić, University of Banja Luka, darija.gajic@aggf.unibl.org
Slobodan Peulić, University of Banja Luka, slobodan.peulic@aggf.unibl.org

ENERGY RENOVATION OF RESIDENTIAL BUILDING ENVELOPE USING ORGANIC MATERIALS FOR THE LEVEL OF COST-OPTIMAL IMPROVEMENT/ UPGRADE IN BOSNIA-HERZEGOVINA AND SERBIA

Abstract

Towards building renovation strategies, the research is led by a very deep renovation of residential buildings, which would reduce the energy need for heating below 40 kWh/m² or create energy savings 60%. The renovation of the building envelope, guided by organic materials (such as wood), which is in the one of key principles in the New Renovation Wave Strategy of the European Union from October 2020, is presented in the paper. Energy saving made by renovating building envelopes using wooden modular systems, are shown through characteristic building on which their application is adequate. Case study from Bosnia and Herzegovina indicate possible energy savings of 81% for residential type Multi-family houses – MFH from period 1961-1970.

Keywords: building renovation strategies, modular building envelope, wood, energy savings

ЕНЕРГЕТСКА ОБНОВА ОМОТАЧА СТАМБЕНИХ ЗГРАДА КОРИШЋЕЊЕМ ОРГАНСКИХ МАТЕРИЈАЛА ЗА НИВО ТРОШКОВНО-ОПТИМАЛНОГ УНАПРЕЂЕЊА У БИХ И СРБИЈИ

Сажетак

У сусрет стратегијама обнове зграда, истраживање се води веома дубоком обновом стамбених зграда, којом би се смањила вриједност потребне енергије за гријање испод 40 kWh/m² или створити уштеду енергије за 60%. Представљена је обнова омотача стамбених зграда која се води органским материјалима, као што је дрво, што представља један од кључних принципа Нове стратегије обнове зграда европске уније из октобра 2020. године. Енергетска уштеда, обновом омотача зграда, кориштењем дрвених модуларних система, приказана је на карактеристичној типској згради. Студија случаја из Босне и Херцеговине указује на потенцијал енергетске уштеде од 81% за стамбени тип зграде – MFH из 1961-1970.

Кључне ријечи: стратегије обнове зграда, модуларни омотач зграда, дрво, уштеде енергије

1. INTRODUCTION

Buildings account for about 40% of total energy consumption in the EU and they are responsible for 36% of greenhouse gas emissions [1].

In countries with higher energy intensity (units of primary energy consumption per unit of GDP of country), energy consumption in buildings is even higher than 50%. The energy intensity of was estimated at 0.40 for B&H [2] and at 0.34 for Serbia [3] (tone of oil equivalent (toe) / 1000 USD of GDP) according to data from the International Energy Agency from 2019. Bosnia and Herzegovina has almost 60% of total energy consumption in buildings [4].

Each EU member state is obliged to adopt documents related to energy savings (National Energy and Climate Plan, and the Strategy for Renovation of Buildings). All countries have the highest energy consumption in buildings, which is why building renovation strategies are being developed and after every 3 years the documents are revised, so that the energy saving plan can be monitored. According to Renovation Wave Strategy, which the EU recently announced in October 2020, [5] only 11% of the EU existing building stock undergoes some level of renovation each year. However, very rarely, renovation works address energy performance of buildings. The weighted annual energy renovation rate is low at some 1%. Across the EU, deep renovations that reduce energy consumption by at least 60% [6] are carried out only in 0.2% of the building stock per year and in some regions, energy renovation rates are virtually absent. At this pace, cutting carbon emissions from the building sector to net-zero would require centuries.

The most important part of the new strategy are sets out key principles for building renovation towards 2030 and 2050, which, among other things, promote the use of organic materials.

Bosnia and Herzegovina, as well as Serbia, although not members of the European Union, are signatories to the Treaty establishing the Energy Community, [7] [8] which is why they are obliged to draft a Building Renovation Strategy. The obligation to draft the Strategy derives from the Decision of the Ministerial Council of the Energy Community from October 2015 [9] by which the Energy Community adopted the binding application of Directive 2012/27 / EU on energy efficiency [10] from the 2017.

The Strategy for the Renovation of Buildings in Bosnia and Herzegovina (by entities, the Strategy for the Renovation of Buildings in The Republic of Srpska until 2050) was presented to the general public at the ENEF Symposium in November 2019 [10], but has not yet been officially adopted. Encouraging investment in the renovation of the national building fund of the Republic of Serbia presented in November 2021 [11]. The Strategies of B&H and Serbia are guided by cost-optimal analyzes prescribed by Regulations No 244/2012 [12]. but do not emphasize the refurbishment of building envelopes by renewable and organic products and materials, but only the use of renewable energy sources.

The research deals with the presentation of modular renovations of buildings in the European Union, which can mostly use organic construction materials, and the presentation of possible applications on existing buildings in Bosnia and Herzegovina and Serbia. In addition, this method of renovation not only follows the key principles for building renovation in the Renovation Wave Strategy, but also allows for improvement to the level of very deep building renovation and nZEB standards. Following the National Typologies of Residential Buildings of Bosnia and Herzegovina and Serbia and the level of improvement of the envelope according to cost-optimal analyzes, the potential for energy savings in the renovation of buildings that are primary for renovation due to the construction period, and over which modular renovation can be performed.

2. BUILDING RENOVATION STRATEGIES

Each EU member state is obliged to adopt documents related to energy monitoring and savings, and as all countries have the highest energy consumption in buildings, it is necessary to develop building renovation strategies. Building renovation strategies have been constantly revised in the EU for 3 years, and the EU recently published recommendations for a new strategy, in October 2020. EU members respect the regular creation of documents for a long-term building renovation strategy until 2050 and to date published strategies for 2015, 2018 and 2021.

The European Union Renovation Wave Strategy, published by the European Commission [5], aims to reduce greenhouse gas emissions, increase material reuse and recycling, stimulate economic recovery after the COVID-19 pandemic, reduce energy poverty and support for achieving the EU's goal of becoming climate neutral by 2050.

In order to achieve the planned total reduction of greenhouse gas emissions in the EU of at least 55% by 2030, it is necessary to reduce emissions from buildings by 60% and their energy consumption by 14%, while the use of energy for heating and cooling must be reduced by 18%.

The most important part of the strategy are sets out key principles for building renovation towards 2030 and 2050: Energy efficiency first; Affordability; Decarbonisation and integration of renewables; Life-cycle thinking and circularity; High health and environmental standards; Tackling the twin challenges of the green and digital transitions together and Respect for aesthetics and architectural quality.

Principle of „Life-cycle thinking and circularity“ it is clarified with minimising the footprint of buildings requires resource efficiency and circularity combined with turning parts of the construction sector into a carbon sink, for example through the promotion of green infrastructure and the use of organic building materials that can store carbon, such as sustainably-sourced wood.

Building renovation strategies are directly related to the Comprehensive National Energy and Climate Plan on the Comprehensive National Energy and Climate Plan, also known by the acronyms NECP and NEKP. The Government has not yet established the legal basis needed for the National Energy and Climate Plan. An early version of the NECP was submitted to the Secretariat in November 2020. The draft NECP is planned to be submitted to the Secretariat for formal comments by the end of 2021, after entity-level energy and climate plans will have been finalized. [13] Serbia is the last member of the Energy Community to start writing an integrated national energy and climate plan. The finalization of the draft NECP is planned by the end of 2021, followed by adoption by the Government in early 2022. [14]

B&H and Serbia, have Action plans that are insurance models in planning until 2030, and are the basis for NCEP. [15] [16] [17]

Strategies renovation of buildings provides an overview by sector along with a list of barriers, funding opportunities, cost-effective proposals, and available materials and energy potentials from renewable sources and heating systems. The concept of construction and renovation is based on an approach that does not have net greenhouse gas emissions and does not show seismic and fire risks. The strategy states the development, among other things, of the key parameter on which the energy need for heating depends, the U-coefficients of building envelopes in Serbia and B&H. The values are shown at the time when Serbia was in the former Yugoslavia, together with Bosnia and Herzegovina, then the year of change 2010, which is still valid. The strategy is guided by cost-optimal analyzes of the renovation of models of typical buildings.

Cost-optimal analysis was based on that period of construction and the type of building, and a combination of applied improvement measures. After a cost-optimal analysis, the Strategy also states what the new U-values should be.

The strategy in Bosnia and Herzegovina, which was presented in November 2019, but which has not yet been adopted due to the situation with the Covid virus, and probably also due to the freedom to adopt documents, because they still do not belong to the European Union, but they have some obligations, because they are members of the Energy Community.

Bosnia and Herzegovina created a strategy that was preceded by the development of a Typology of Buildings, followed by a cost-optimal analysis, which considered various variants of the height of the U-values for the building envelope and their performance on the market of country.

The Republic of Srpska (entity of Bosnia and Herzegovina) Building Renovation Strategy assumes three scenarios, representing different levels of ambition for future renovation, based on two drivers: renewal rate, defined as the ratio of the usable floor area of annually renovated buildings to the total usable area of the entire building stock, and depth of renovation, which indicates the energy savings achieved through the choice of renovation measures. [18]

Cost-optimal analysis included different packages of 33 measures to the two most common types of housing: single-family house and multifamily house. Measures that improve the envelope, specifying thickness and thermal conductivity of the material/insulation or U-value of the product-window, are discussed without specifying the use of renewable materials. The measures of improvement of the heating system and domestic hot water (DHW) system mention the centralization of the system and the use of renewable energy sources.

Bosnia and Herzegovina performed an analysis on real buildings and the parameters for the building envelope were taken according to the regulations depending on the period of construction, while Serbia performed an analysis on models which represent partially corrected typical buildings, with all their material and technical features.

In B&H, individual houses built before 1980, are the most vulnerable from the aspect of renovation, because they have the highest level of energy need for heating. In the Strategy concluded that the

heated area is larger in houses after 1980, and projection was made on such buildings. And for residential multi-family buildings, the period before and after 1980 is also analyzed. Public buildings were treated as individual houses. The starting point for the formation of the Strategy in B&H are the cost-optimal analyzes for residential and non-residential buildings done during 2016-2017. The local cost is optimum, when, despite some differences in the reference buildings in all cases U-values are: for external walls $0.3 \text{ W/m}^2\text{K}$, for roof $0.2 \text{ W/m}^2\text{K}$ and for windows $1.6 \text{ W/m}^2\text{K}$. The strategy states that the greatest energy savings, about 60%, will be when we apply all these measures. By applying all measures, the price of the investment is twice as high, while energy consumption has been reduced by five times. The greatest emission reduction effects can be expected by changing fuels and / or improving the efficiency of heating systems. For multi-family buildings, a pellet heating boiler is preferred. In many places, measures are mentioned to replace old windows with PVC windows, which is unacceptable to write in the strategy, because it automatically favored this type of frame, which is not an organic material.

In Serbia summarizing the periods of construction, two characteristic buildings built before 1960, ie after 1960, were singled out and selected as reference, with the aim of representing the entire construction fund of old buildings and buildings built after the beginning of the application of these regulations, ie. since 2013 (new buildings). The starting point for the formation of the Strategy in Serbia are the cost-optimal analyzes for residential and non-residential buildings done during 2019-2020.

Improvement measures have been defined for all buildings and packages of measures have been formed. Five possible renovation scenarios have been prepared, of which the first, the basic scenario implies unsubsidized renovation and construction according to the current regulations, and the last, most advanced one envisages the renovation of buildings at the level of almost zero energy buildings. Scenario 4 was proposed as the basis for the Strategic Goal of the Republic of Serbia. Scenario 4 is a scenario with an increased coverage and level of improvement of the adopted packages of measures and with an increased reduction of CO₂ emissions of 31% compared to the initial situation in 2020 and a reduction of primary energy consumption in 2050 of 38% compared to 2020 consumption. years.

In the strategy of Serbia does not state the cost-optimal level through the U-values of the building envelope. In the current Ordinance on the energy efficiency of buildings, the limit values of the U-coefficients are specifically stated for the renovation of existing buildings and for new buildings. In Serbia, for existing building U-values are: for external walls $0.4 \text{ W/m}^2\text{K}$, for roof $0.2 \text{ W/m}^2\text{K}$ and for windows $1.5 \text{ W/m}^2\text{K}$ and for floor $0.4 \text{ W/m}^2\text{K}$ and for new building U-values are: for external walls $0.3 \text{ W/m}^2\text{K}$, for roof $0.15 \text{ W/m}^2\text{K}$, for windows $1.5 \text{ W/m}^2\text{K}$ and for floor $0.3 \text{ W/m}^2\text{K}$. [19]

Scenario 4 in Serbia is considered a deep renovation, because Scenario 5 is intended for nZEB, and as BiH requires deep renovation of the entire building envelope resulting from cost-optimal analysis, and following the requirements of the New Renovation Wave Strategy, it is necessary to point out possible deep renovations envelope of buildings with organic materials that will reduce the value of the energy indicator, the energy need for heating, by 60%.

3. DEEP ENERGY RENOVATION OF THE RESIDENTIAL BUILDINGS USING MODULAR PREFABRICATED SYSTEMS

Presented projects show variety of methodologies in research on the prefabricated modules retrofitting. It is interesting to see different approaches in setting typologies, how to classify them in the categories, ways to survey buildings, do building construction and envelope analysis, and see how to set exact aspects that retrofitting should accomplish. Some of the projects mostly answered affirmatively, however some remained unclear on methodology of surveying or building typology classification.

TES Energy Façade (Prefabricated timber based building system for improving the energy efficiency of the building envelope), Table 1, presented a very comprehensive and systematic approach in upgrading buildings energy performance. [20]

This project is probably one of the most thorough studies on this topic. It shows state of art approach in thinking modular retrofitting. Detailed and systematic division of the building stock according to several criteria (especially in Germany) enables excellent background for further research and development on modules. A holistic approach in gathering wide range of influencing aspects on design is great methodology in getting most optimal design which will answer on demanding aesthetical, fire-safety, ecology and energy standards. This project questions not only energy performance of the building, but also, building soft skills such as layout adjustment for future demands, thus prolonging life cycle of the buildings.

Table 1. Key aspects of the TES Energy Façade project [20]

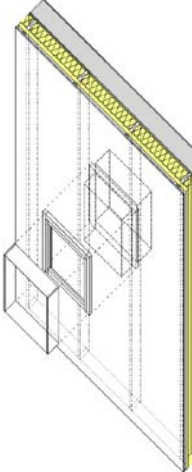
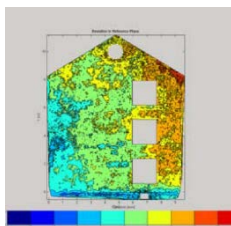
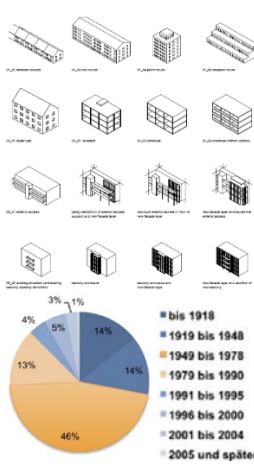
Project name	Countries	Example of the modular panel	Existing structure survey	Building typology
TES Energy Façade Prefabricated timber based building system for improving the energy efficiency of the building envelope	Finland, Germany, Norway		Photogrammetry, tachymetry and/or 3D laser scanning of the existing structure. Pictures below shows deviation on the wall surface derived by sophisticated mapping systems. 	 <ul style="list-style-type: none"> bis 1918 1919 bis 1948 1949 bis 1978 1979 bis 1990 1991 bis 1995 1996 bis 2000 2001 bis 2004 2005 und später

Smart-**TES EXTENSIONS** is the continuation of the previous project (TES Energy) and is a step forward to building extensions rather than classic retrofit (usually narrowed to the envelope level), Table 2. Project results booklet showed several types of these extensions - horizontal, annex, vertical annex, terrace/ balconies annex etc. Since the name is about the extensions, often several stories high, this project explained load transfer - via TES facade and extensions, via esxtensions, via extensions and existing building, via existing building loadbearing structure [20]. Also, functional differentiation is considered since horizontal annexes typically affect existing flats and rooms (layout, ventilation, insolation etc.), compared with vertical annex that can perform independently. Prefabricated space modules required special attention for the transport requirements different among involved countries [20].

Table 2. Key aspects of the Smart-**TES EXTENSIONS** [21]

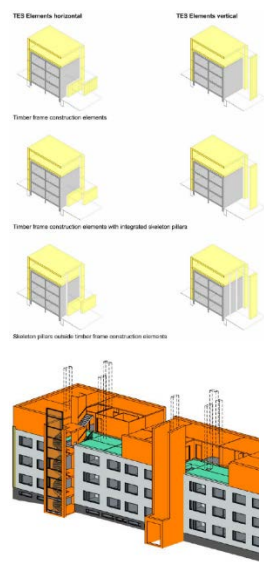
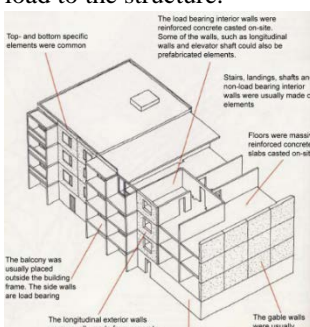
Project name	Countries	Example of the modular panel	Existing structure survey	Building typology
Smart-TES EXTENSIONS	Finland, Germany, Norway		Existing buildings are measured using special 3D laser scanning technologies to ensure perfect fit of the prefabricated modules to the existing building fabric.	Building typology is now based on research of building components, load-bearing elements and load transfer. This was necessary for development of the modules as annexes that will add significant amount of new load to the structure. 

This study is a good example of the long research projects which are being developed furthermore through time and with systematic approach of case-study learning. Buildings upgrades are good principle due to necessity to reduce needs for demolitions of old buildings, thus make less construction waste in the dumpfields. Old buildings often do not have elevators, have poorly insulated roof or are missing balconies, which are examples also shown in the booklets. This project shows modular examples of how these problems can be overcome making good scientific and practical background even for other countries with same building stock problems.

ECBCS (Prefabricated systems for Low Energy Renovation of Residential Buildings) is a project where combines best approach in both on-site and software approaches, going with the case by case methodology rather than unification of overall process, Table 3. [22] Reduce energy consumption needs to the range of 30 - 50 kWh/m² per year for heating and domestic hot water.

Thus, panels can be slightly optimized accordingly what can result in better overall building performance and economical benefit of the investment. Project resulted with 6 successful demonstration sites (*until 2012 report) in Austria, Netherlands and Switzerland. Energy consumption goals were fully achieved; furthermore, with solar installations these demands were reduced almost to zero [22].

Table 3. Key aspects of the ECBCS project [22]

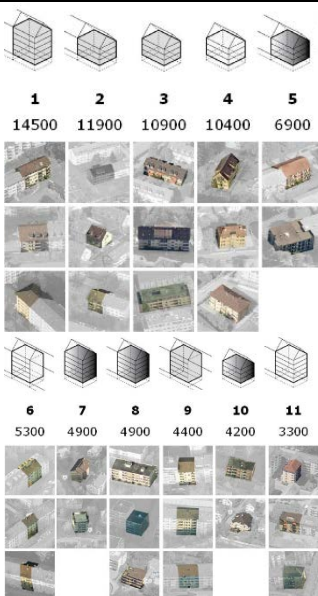
Project name	Countries	Example of the modular panel	Existing structure survey	Building typology
ECBCS Prefabricated systems for Low Energy Renovation of Residential Buildings	Austria, Czechia, France, Netherland, Portugal, Sweden Switzerland		Existing buildings are measured using special 3D laser scanning technologies to ensure perfect fit of the prefabricated modules to the existing building fabric.	 <p>1 2 3 4 5 14500 11900 10900 10400 6900</p> <p>6 7 8 9 10 11 5300 4900 4900 4400 4200 3300</p>

Each of projects gave some interesting conclusions and this work will try to present similar methodology possible to be implemented on the case studies in Bosnia-Herzegovina and Serbia.

4. ENERGY RENOVATION POSSIBILITIES OF THE BUILDING ENVELOPE OF EXISTING RESIDENTIAL BUILDING STOCK IN B&H AND SERBIA WITH MODULAR PANELS

Comparative analysis of data on the residential building fund of B&H and Serbia, was carried out through a methodological framework for research of typology of residential buildings based on the European international research project "TABULA" in accordance with directives 2002/91 / EC and 2006/32 / EC and co-financed by the European Commission program IEE. The TABULA project, initiated by researchers at the Darmstadt IWU Housing and Ecology Institute, establishes a unique framework for the classification of typology of residential buildings in Europe, with a defined methodology for calculating the energy performance of buildings. Both project Typologies of Residential Buildings in Bosnia and Herzegovina [23] and Serbia [24] an absolute and specific energy need for heating was calculated for the total of 29 representative residential buildings in B&H and 39 representative residential buildings in Serbia, which represent six categories of buildings classified into six and eight periods of construction. For the purpose of comparing countries according to the TABULA methodology [25] it was reduced to 22 buildings for BiH divided into 4

categories and 6 periods, and for Serbia 31 buildings divided into 4 categories and 8 periods. All buildings older than 40 years should have a deep renovation, not only because thermal protection legislation has improved in the last 40 years and is constantly improving, but also in terms of efficiency, the estimated duration of building envelopes are 30 years, while technical systems are 15 years. [26]

Every building is unique, like snowflakes. But looking from a distance snowflakes are alike. Same goes for buildings. With some assumptions and for some specific observations a group of buildings are the same. And a single representative of those buildings is typical building. As is the case with the refurbishment of prefabricated timber panels, a unique envelope would have to be designed and constructed for each building individually. [23]

Adequate buildings for the application of prefabricated timber panels are selected according to three criteria: - layout, which allows modular division of the facade sheath; - the period of construction, which requires as a whole the complete thermal improvement of the envelope, and - the quantity of such buildings within the species. Collective residential buildings (MFH and AB), in contrast to individual residential buildings (SFH and TH), also have larger envelope areas that need to be renovated and, depending of the type of building (buildings with more of the same slats and floors), can be heat-upgraded with the same pre-fabricated elements of organic materials, which are also the subject of this analysis.

4.1 EXISTING RESIDENTIAL BUILDING STOCK FOR ENERGY RENOVATION MODULAR ENVELOPE

Specifically, the potential of the construction period 1960-1980 was investigated. The construction of prefabricated reinforced concrete systems in the EU began in 1960 [27], while in BiH and Serbia the imitation of prefabrication began, and after 1970 the construction of complete prefabrication of residential buildings began. Today, such buildings are adequate for renovation with modular panels, which would be made in industrial conditions and installed on site in its entirety on the existing casing. The characteristics of such residential buildings are that they were built as free-standing (MFH) or lamellas (AB), Figure 1., and that their number of floors is 4 or more and that there are at least 20 apartments within such structures.

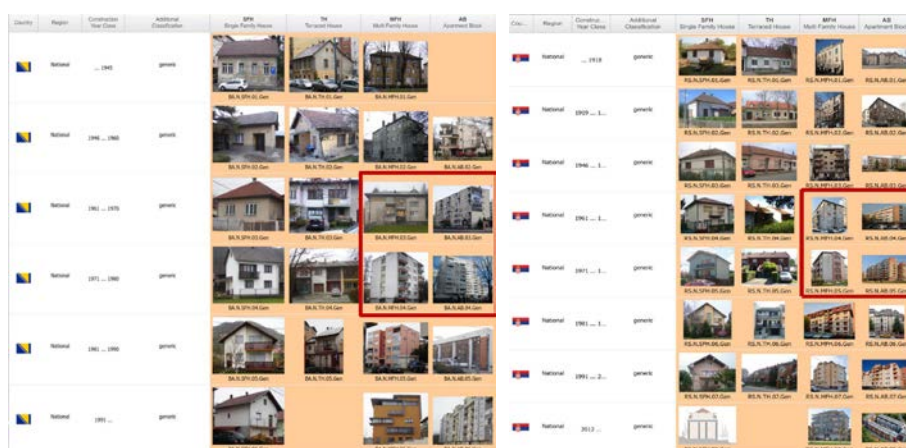

Figure 1. Typology of residential buildings of Bosnia and Herzegovina (left) and Serbia (right) [28] [29]

In addition, they are usually connected to inefficient district heating. Building renovation strategies usually refer to buildings whose renovation can generate energy savings of 60% or more, but priority must be given to buildings where renovation would solve health and energy poverty problems for users [30]. From the Typology we can see how many buildings there are free-standing (MFH) and slats (AB) and what is their ratio compared to other types of buildings. The potential building stock over which the building envelope could be upgrade has been examined through a comparative analysis of data on the building stock of both countries. Bosnia and Herzegovina and Serbia have a predominantly higher number of buildings / houses intended for individual housing (B&H 97.63%, SRB 97.32%), compared to the number of collective housing. Serbia has 61.6% more buildings compared to B&H, from which SFH 56%, TH 72.5%, MFH 73%, and AB 46.6%. Periods 1961-1970 and 1971-1980 for the collective housing (MFH and AB) has mutually in B&H 9,355 buildings (compared to number of all buildings 1%, in relation to the number of the same types 45.8%), while in Serbia this number, 2.5 times higher than the number of buildings in BiH, is 24,372 buildings (in

relation to the number of all types of buildings 1%, and in relation to the number of the same types 40.5%). But when looking at the number of dwelling units within these buildings, the ratio decreases, because the number of dwellings in individual buildings is 66.47% in B&H and 73% in Serbia respectively, what is shown in the Table 4.

In B&H, the total number of individual dwelling buildings is about 841,543 while the number of collective dwelling buildings is around 20,422. When observing the number of dwelling units, 10,764,240 belongs to individual dwelling, while 542,945 belong to collective dwelling. In Serbia, the total number of individual dwelling buildings is about 2,186,246, while the number of collective dwelling buildings is about 60,074. When looking at the number of dwelling units, 2,327,707 belong to individual dwelling, while to collective dwelling 860,707, Table 4.

Comparative analysis indicates that although Serbia has a larger number of buildings of all types, the ratio to the number of apartments is lower, ie 61.6% more individual buildings have Serbia, while the ratio to the number of apartments is 50.8% for Serbia.

Table 4. Number of residential buildings and apartments in comparative countries

	Bosna and Herzegovina		Serbia	
	number of buildings	number of apartments	number of buildings	number of apartments
SFH and TH	841,543	1,076,240	2,186,246	2,327,707
MFH and AB	20,422	542,945	60,074	860,707
MFH and AB (1961-1980)	9,355	297,644	24,372	402,891
MFH (1961-1980)	5,215	103,143	17,265	223,910
Total	861,965	1,619,185	2,246,320	3,188,414

In B&H, the number of dwellings in types MFH and AB of the period from 1961 to 1980 in relation to all periods of collective housing buildings is 74.2%, while in relation to all types and periods of buildings it is 18.38%. In Serbia, the number of dwellings in the types of MFH and AB periods from 1961 to 1980 in relation to all periods of collective housing buildings is 46.8%, while in relation to all types and periods of buildings, it is 12.63%.

Although both types of buildings are suitable for modular envelope renovation, this study will present the possibility of energy renovation for the MFH type. By comparing the number of buildings and apartments of the MFH type, in the mentioned period, although Serbia has 3.3 times more buildings than B&H, but the ratio of apartments is reduced to 2.2 times. The average shows that one MFH type building has about 20 dwelling units in B&H, while in Serbia the average is about 13 dwelling units per MFH type building.

For the calculation requirements, it was assumed that the entire building surface used for residential purposes was heated. In regional countries it was estimated that only 50% of households heated over 50% of conditioned area [31] whereas indicators for the EU countries are somewhat better [30].

Such is the situation with buildings / houses of individual housing, and after the renovation of such buildings, real savings of delivered energy could not be seen. Collective housing buildings are important for this research and the energy need for heating such buildings is estimated. The experts calculations estimates of energy need for heating individual buildings of all types and Table 5. are presented comparison B&H and Serbia by type MFH for construction periods 1961-1970 and 1971-1980. An assessment of such indicators of the energy need for heating shows that although the same name and period of construction, especially since the two countries were under the same legal regulations and requirements for the building envelope until the 1980s, can only indicate higher shape factors of the selected representative example of MFH for period 1971-1980 in Serbia.

Table 5. Comparison value of energy need for heating representative residential buildings in Bosnia and Herzegovina and Serbia (kWh/ m²a)

	Bosnia and Herzegovina	Serbia
	MFH	MFH
1961-1970	188.44	172.00
1971-1980	146.80	191.00

Looking at the period 1961-1970, MFH have 8.7% higher energy need for heating buildings in B&H. Period 1971-1980, for MFH have 23% higher energy need for heating buildings in Serbia.

4.2 CASE STUDY OF ENERGY RENOVATION OF RESIDENTIAL BUILDING WITH ORGANIC MODULAR ENVELOPE

Case study presented on representative sample of buildings in Banja Luka (Bosnia and Herzegovina). A representative samples of an existing residential building is determined by a detailed energy audit - determining the specific energy consumption for heating using EN ISO 13790:2008 - Energy performance of buildings – Calculation of energy use for space heating and cooling. The Sample of characteristic period (1961-1970) led to the conclusion that real Sample from 1964 has a lower specific energy need for heating than representative building of MFH from same period of construction from Typology, Table 6.

Table 6. Comparative review of the energy need for heating of representative sample of existing residential building before and after renovation of building envelope

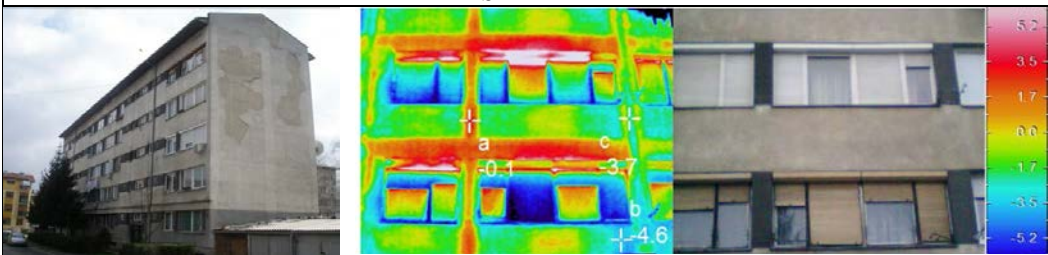
SAMPLE			
			
Layout of building and thermal-vision image before renovation			
PERIOD	1964		
DIMENSION	10x42m		
HEATED SPACE AREA	2025m ²		
No OF FLOORS	P+4		
HEATED SPACE VOLUME	5670m ³		
heat capacity	Wh/m ² a	72	
metabolic heat from person	W/m ²	3.8	
ORIENTATION	NW - SE		
		BEFORE	AFTER
U-value WALLS	W/m ² K	2.03	0.30
U-value WINDOWS	W/m ² K	3.12	1.60
U-value ROOF	W/m ² K	1.64	0.20
U-value FLOOR	W/m ² K	1.02	0.30
g-value	-	0.49	
A/V ratio	-	0.40	
Percentage of window area	%	23.70	
infiltration	1/h	0.60	0.50
		BEFORE	AFTER
internal temperature	°C	20.0	20.0
setback temperature	°C	16.7	16.7
	internal heat gains		
ventilation	kWh/m ² a	0.0	0.0
lighting	kWh/m ² a	2.6	2.6
various equipment	kWh/m ² a	13.5	13.5
ENERGY NEED FOR HEATING	kWh/m ² a	164.4	31.2

Sample is a compact building, rectangular in shape with no sunshade element like overhang, balcony or loggias, with form factor of the building (A/V ratio) of 0,40.

A detailed energy audit was conducted for building. The calculation was guided by the design parameters of the building envelope characteristic for the specified period, with data characteristic of the real environment of the building (climate data and built environment) and the use of the building (building users and devices). The calculated value of the energy need for heating the existing selected sample corresponds to the average value stated for typical buildings in the Typologies of B&H and Serbia. Table 6.

By applying cost-optimal measures on the sample envelope, it is possible to lower the value of the energy need for heating below 40 kWh/m^2 .

The project of renovation of the envelope of the sample buildings in the modular system, which are described in Chapter 3, was developed at the combined master study "Energy efficiency in buildings" at the University of Banja Luka. In this case five modules were defined total façade envelope (façade panels made with wooden substructure filled with thermal insulation with wooden frame windows) with energy characteristics defined by cost-optimal analysis in B&H, Figure 2.

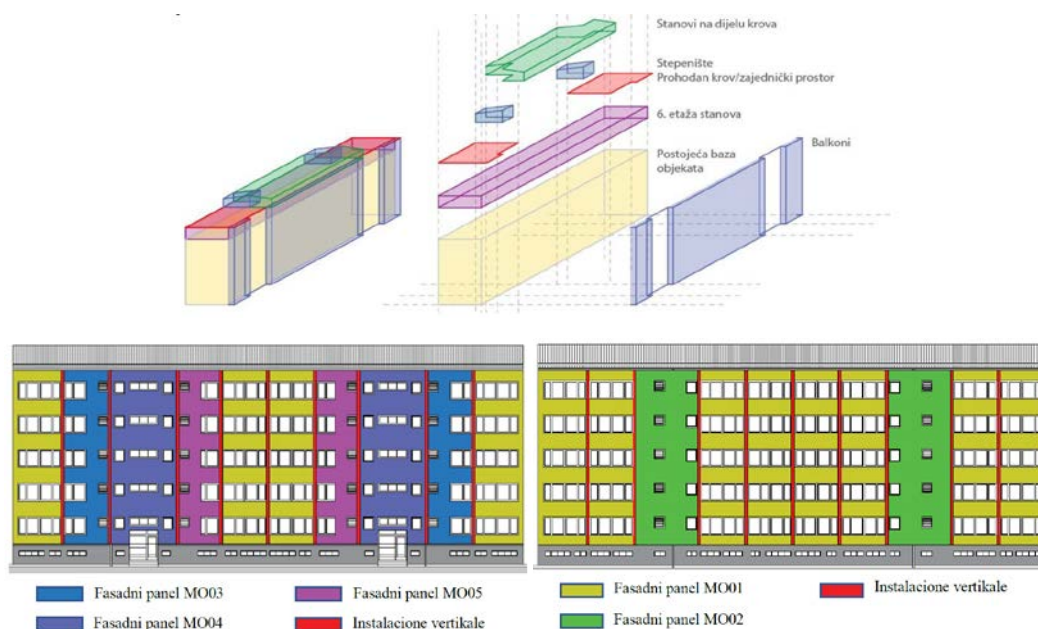

Figure 2. Sample 1 – Design for the renovation of the building envelope [32]

The renovation of the building envelope was done from the conceptual design to the details, with energy analysis and bill of quantities and recalculation of works, in order to determine energy savings and economic viability of the investment. For Sample, the solution is guided by prices from 2020. It was concluded that in addition to the renovation of the envelope, it is necessary to upgrade the building with new dwellings and the addition of new technical systems for energy production to enable their initial investment in such renovation.

5. POSSIBILITIES OF ENERGY SAVINGS AFTER ENERGY RENOVATION OF BUILDING WITH ORGANIC MODULAR ENVELOPE

Follow the same standard EN ISO 13790 standard, energy requirements of buildings are calculated and expressed in Typologies of buildings in Bosnia-Herzegovina and Serbia. In typologies of building are stated energy savings after applying the measures on the building envelope, which are governed by the valid country regulations and called the standard improvement of building energy performance.

In Bosnia-Herzegovina, the measures applied are more demanding for the wall and window than prescribed in the Federation of Bosnia-Herzegovina regulation, while in entity Republic of Srpska they reach the U-value for windows and do not reach the predicted U-value for walls. Standard improvement measures in typology of residential building defined in accordance with usual measures applied during building reconstruction in the territory of B&H, (improvement of thermal characteristics of walls and ceilings by technically common procedures – added thermal insulation 10 cm thickness with $\lambda=0,041 \text{ W/mK}$) as well as a possible replacement of the existing windows with new ones, with better characteristics (defined minimal U-value $1,60 \text{ W/m}^2\text{K}$).

In Serbia, the measures applied from valid regulation for existing buildings (external walls $0,4 \text{ W/m}^2\text{K}$, roof $0,2 \text{ W/m}^2\text{K}$, windows $1,5 \text{ W/m}^2\text{K}$ and floor $0,4 \text{ W/m}^2\text{K}$). Table 7.

Analyzing for the current condition of buildings and their values of energy need for heating of representative types, examples of the case study from B&H are closer to the values of energy need for heating types of Serbia.

Table 7. Comparative representation of energy need for heating in kWh/m² of representative examples of MFH buildings, before and after applying standard measures in Typologies of B&H and Serbia and from case study

		MFH	MFH
		Before measure	After measure
Bosnia and Herzegovina	1961-1970	188.44	67.86
	1971-1980	146.80	68.23
Serbia	1961-1970	172.00	55.00
	1971-1980	191.00	72.00
Case study	1964	164.40	31.20

Applying these measures to restore the envelope in Typologies, would create 60% energy savings in almost all buildings, except for the type MFH from the period 1971-1980 in B&H (53%). The reason for this can be found in the fact that in B&H types MFH existing condition has a lower value of energy need for heating. In case study, Sample were treated with cost-optimal measures in the B&H area, which is listed in Table 6, and which leads to savings of 81% for MFH type.

For these characteristic type of buildings, which could be overhauled in a modular system, from case study, we can analyze the possibilities of energy savings in MWh/a by country, applying standard measures from Typology and cost-optimal measures applied in the case study, Table 8.

Table 8. Energy need for heating of MFH in B&H and Serbia before and after standard measures and case study measures (MWh/a)

		MFH	MFH	MFH	MFH	MFH
		Before measure	After measure from Typology	Saving energy	After measure from case study	Saving energy
Bosnia and Herzegovina	1961-1970	327,081	117,787	209,294	54,155	272,926
	1971-1980	189,255	68,938	120,317	31,523	157,732
	total			329,611		430,658
Serbia	1961-1970	1,532,704	981,213	551,941	556,615	976,089
	1971-1980	2,442,013	1,453,841	988,172	629,997	1,812,016
	total			1,540,113		2,778,105

Comparative analysis shows that the amount of energy that can be further saved by applying cost-optimal measures compared to standard measures listed in the Typologies is in B&H for type MFH about 23.4%, while in Serbia for type MFH about 44.5%.

The analysis shows that cost-optimal measures, which with slightly more demanding U-values for the non-transparent part of the envelope (external walls 0.30 W/m²K, roof 0.20 W/m²K and floor 0.30 W/m²K) than standard measures in Serbia and Bosnia and Herzegovina, and even for windows and less demanding U-value (1.60 W/m²K), they can save for MFH in B&H 430,658 MWh/a and in Serbia 2,778,105 MWh/a.

6. CONCLUSION

Currently, in new EU strategy favors the deep renovation, energy savings, about 60% and it includes, to renovate of the all envelope of building. Cost-optimal analysis based on energy and economic analysis of measures for the renovation of buildings in Bosnia and Herzegovina, published in the B&H Strategy, indicated that U-values should be 0.30 W/(m²K) for an external wall, 1.60 W/(m²K) for an opening of the envelope (windows and doors), 0.30 W/(m²K) for a ceiling under an unheated space (roof), and 0.30 W/(m²K) for a ceiling above an unheated space (floor).

Renovation of the envelope of existing building of type MFH, in a case study, which reaches the above measures, showed that it is possible to lower the value of energy need for heating below 40 kWh/m², or according to the requirements of the Strategy to create savings 60% (from case study 81% for MFH).

In addition, as the New Renovation Wave Strategy in one of the key principles of building renovation towards 2030 and 2050 extends the use of organic building materials, case studies have shown the application of these cost-optimal measures through a modular system in organic materials, systems that could accept new technical systems, which should be considered in case of renovation of buildings to nZEB standards.

LITERATURE

- [1] IRP, Resource Efficiency and Climate Change, 2020, and UN, Environment Emissions Gap Report, 2019.
- [2] International energy agency. [On-line] Available: <https://www.iea.org/countries/bosnia-and-herzegovina> [2019]
- [3] International energy agency. [On-line] Available: <https://www.iea.org/countries/serbia> [2019]
- [4] Government of Republika Srpska. Share of energy use and energy sources for Republika Srpska according to the Energy Balance Plan for 2019. [On-line] Available: http://www.vladars.net/sr-SP-Cyrl/Vlada/Ministarstva/mper/Documents/202019_355880114.pdf
- [5] European commission, “Renovation Wave Strategy”, 2020, Internet: https://ec.europa.eu/energy/sites/ener/files/eu_renovation_wave_strategy.pdf [2021]
- [6] Commission Recommendation on Building Renovation (EU) 2019/786, 2019.
- [7] Bosnia and Herzegovina Presidency, (2006, August 25). Energy Community Treaty, no. 09/06, od 25.08.2006.).
- [8] Law on Ratification of the Energy Community Treaty between the European Community and the Republic of Albania, the Republic of Bulgaria, Bosnia and Herzegovina, the Republic of Croatia, the Former Yugoslav Republic of Macedonia, the Republic of Montenegro, Romania, the Republic of Serbia and the United Nations Interim Mission in Kosovo. with United Nations Security Council Resolution 1244 [Official Gazette of Republika Srpska, no. 62. from 19. july 2006].
- [9] Council of Ministers of the Energy Community. “Decision D/2015/08/MC-EnC from October 2015.”. Internet: <https://www.energy-community.org/legal/decisions.html>
- [10] European Parliament and the Council. (2012, November 11., L 315) Directive 2012/27/EU from 25 October 2012 on energy efficiency, amending Directives 2009/125/EC and 2010/30/EU and repealing Directives 2004/8/EC and 2006/32/EC. [Official Journal of the European Union]
- [11] Ministry of Spatial Planning, Construction and Ecology of the Republic of Srpska. (2019) Draft Strategy for the renovation of buildings in the Republic of Srpska until 2050. in 4th scientific-professional symposium Energy efficiency in building engineering – ENEF. [On-line] Available: http://www.enef.etfbl.net/2019/resources/ENEF_2019_PP22.pdf
- [12] Ministry of Spatial Planning, Construction and Ecology of the Republic of Serbia, [On-line] Available: <https://www.mgsi.gov.rs/sites/default/files/Predlog%20Dugorocne%20strategije%20PUONFZRS.pdf>
- [13] Energy Community. [On-line] Available: https://www.energy-community.org/implementation/Bosnia_Herzegovina/CLIM.html (2022)
- [14] Energy Community. [On-line] Available: <https://www.energy-community.org/implementation/Serbia/CLIM.html> (2022)
- [15] Government of the Republic of Srpska. Action plan for Energy Efficiency. [On-line] Available: https://www.vladars.net/sr-SP-Cyrl/Vlada/Ministarstva/mper/std/Pages/Akcioni_plan_za_energetsku_efikasnost_.aspx
- [16] Ministry of Foreign Trade and Economic Relations of BiH. Energy Efficiency Action Plan in Bosnia and Herzegovina for the period 2019-2021. [On-line] Available: <https://ekonsultacije.gov.ba/legislativeactivities/details/113022->
- [17] Ministry of Energy and Mining of the Republic of Serbia. The fourth action plan for energy efficiency of the Republic of Serbia until December 31, 2021, <https://www.mre.gov.rs/sites/default/files/2021/10/4.appe-26avg2021.pdf>
- [18] Gajić D., Peulić S., Mavrič T., Sandak A., Tavzes Č., Malešević M., Slijepčević M., Energy Retrofitting Opportunities Using Renewable Materials—Comparative Analysis of the Current Frameworks in Bosnia-Herzegovina and Slovenia. Sustainability 2021, 13, 603. 2021.

- [19] Rulebook on energy efficiency of buildings (Official gazette no. 61/2011) [On-line] Available:<https://www.mgsi.gov.rs/sites/default/files/PRAVILNIK%20%20ENERGETSKOJ%20EFIKASNOSTI%20ZGRADA.pdf>
- [20] Heikkinen, P, Kaufmann, H, Winter, S, Larsen, KE, 2009, EnergyFaçade – prefabricated timber based building system for improving the energy efficiency of the building envelope, Research project from 2008-2009, Woodwisdom-Net, Helsinki
- [21] Ed. Tulamo T.-S., Cronhjort Y., Riikonen V., Kolehmainen M., Nordberg K., Huß W., SmartTES Innovation in timber construction for the modernisation of the building envelope Book 2 TES Extension. 2014.
- [22] Zimmermann M., ECBCS Annex 50 Prefabricated systems for Low Energy Renovation of Residential Buildings: Project Summary Report. 2012.
- [23] Arnautović-Aksić, D., Burazor M., Delalić N., Gajić D., Gvero P., Kadrić Dž., Kotur M., Salihović E., Todorović D. i Zagora N., Tipologija stambenih zgrada Bosne i Hercegovine, Sarajevo: Arhitektonski fakultet Univerziteta u Sarajevu , 2016.
- [24] Jovanović Popović, M., Ignjatović D., Radivojević A., Rajčić A., Đukanović Lj., Đuković Ignjatović N., Nedić M., National Typology of Residential Buildings in Serbia, Beograd: Faculty of Architecture University of Belgrade, 2013
- [25] Loga, T., Stein, B., & Diefenbach, N. (2016). TABULA Building Typologies in 20 European countries – making energy-related features of residential building stocks comparable. *Energy and Buildings*, <http://dx.doi.org/10.1016/j.enbuild.2016.06.094>.
- [26] Gajić D., Sandak A., Peulić S., Tavzes č., Mavrič T., Prefabricated timber panels application possibilities for the energy refurbishment of residential buildings envelope in Bosnia-Herzegovina and Slovenia. International Conference on contemporary theory and practice in construction XIV. 2020.
- [27] Giebeler, G., Fisch R., Krause H., Musso F., Petzinka K.-H. and Rudolphi A., Refurbishment Manual, Basel, Boston, Berlin: Birkhäuser, 2009.
- [28] Residential Building Typology of Bosnia and Herzegovina. [On-line] Available: <https://episcopes.eu/building-typology/country/ba/>
- [29] Residential Building Typology of Serbia. [On-line] Available: <https://episcopes.eu/building-typology/country/rs/>
- [30] Atanasiu, B. (2014). Alleviating fuel poverty in the EU. Buildings Performance Institute Europe (BPIE).
- [31] Csoknyai, T., Hrabovszky-Horvátha, S., Georgiev, Z., Jovanovic-Popovic, M., & all. (2016). Building stock characteristics and energy performance of residential buildings in Eastern-European countries. *Energy and Buildings*, <http://dx.doi.org/10.1016/j.enbuild.2016.06.062>
- [32] Huseinbašić E., Jojić A., Petrović S., Jović D., Radaković M., (2020) Desing for the renovation of the building envelope; student seminar paper. University of Banja Luka; Faculty of Architecture, Civil Engineering and Geodesy.



Tanja Mitrović, University of Novi Sad, mitrovictasa@gmail.com
Vesna Stojaković, University of Novi Sad, vesna100jakovic@gmail.com
Milica Vračarić, University of Novi Sad, vracharic.milica@gmail.com

AN EXAMINATION OF THE IMPACT OF THE SPATIAL LAYOUT OF MARKET STALLS ON THE QUALITY OF THEIR VISIBILITY USING ISOVIST FIELD: A COMPARATIVE ANALYSIS

Abstract

City markets attract people with their content. Whether this content will be visually perceived depends on its exposure to users. It is generally known that users naturally gravitate towards spaces that are clear and easy to navigate. Visual-spatial quality is therefore one of the main characteristics of such city spaces, which are often overlooked in the design process, and it is necessary to work on their improvement. The purpose of this research is to make a contribution in terms of the possibility of incorporating visibility analysis into the decision-making process in city markets design by using isovist fields to evaluate their visual-spatial configurations.

Keywords: isovist, visibility, comparative analysis, spatial layout

ИСПИТИВАЊЕ УТИЦАЈА ПРОСТОРНОГ РАСПОРЕДА ПИЈАЧНИХ ТЕЗГИ НА КВАЛИТЕТ ЊИХОВЕ ВИДЉИВОСТИ КОРИШЋЕЊЕМ ISOVIST ПОЉА: КОМПАРАТИВНА АНАЛИЗА

Сажетак

Градске пијаце привлаче људе својим садржајем. Да ли ће тај садржај бити адекватно визуелно перципиран зависи од његове изложености корисницима. Опште је познато да корисници природно гравитирају ка просторима који су прочишћени и једноставни за сналажење. Визуелно-просторни квалитет је једна од главних карактеристика оваквих градских простора, који се у процесу пројектовања често занемарују, те је неопходно радити на њиховом унапређењу. Сврха овог истраживања је давање доприноса у смислу могућности инкорпорирања анализе видљивости у процес доношења одлука у пројектовању градских пијаца коришћењем *isovist* поља за евалуацију њихових визуелно-просторних конфигурација.

Кључне ријечи: "isovist", видљивост, компаративна анализа, просторни распоред

1. INTRODUCTION

The shape of the market building floor plan, which implies the dimensions of the building, but also the dimensions and arrangement of the market stalls, affects visibility. In other words, the design of the shape of the circulation space can improve the visibility of the stalls to customers, and thus the conditions of their purchase. However, the "shape" is not explicitly defined in the visibility literature. The shape is a general term and can be referred to different layout properties. The visibility literature does not offer any quantified measures to evaluate how a floor plan determines visibility, especially not for facilities such as cities markets.

The computerized 2D abstraction of possible visual perceptions at the observer's position, or isovist, was developed by Benedikt and Davis [1]. Michael Benedikt defined an isovist as "the set of all points visible from a single vantage point in space with respect to an environment" [2]. He introduced a set of analytical measurements of isovist properties for the purpose of quantitative descriptions of spatial environments. Benedikt begins by considering the volume visible from an observer's location and then simplifies this representation by taking a horizontal slice through the "isovist polyhedron". The shape and size of an isovist are liable to change with the observer's position. Benedikt further notes that, in order to quantify a whole configuration, more than a single isovist is required, which led him to formulate the "isovist field" of his measurements [2]. Isovist fields record a single isovist property for all locations in a configuration using contours to show how these features vary through space [3].

The aim of this paper is to examine the impact of the spatial layout of market stalls within market buildings on their perceptibility by the users, which in this paper is called visibility. Two specific city markets were selected for the study - Limanska Market and Futoška Market, which are the most commonly visited markets in Novi Sad. They are best supplied with agricultural products and various goods and accordingly, they are considered one of the busiest places in Novi Sad. A comparative visibility analysis for the existing and experimental spatial distribution of stalls in these markets was performed. Visibility analyses were performed using Grasshopper within the Rhinoceros.

2. METHOD

In this paper, the inner spaces of the two city markets are converted into "isovist fields" in the computational analysis to examine the visual qualities of these spaces. Grasshopper provides an isovist component that computes the 2-dimensional single isovist. Although a 3-dimensional representation of visible space can be calculated, due to the speed of calculation in architectural analyzes, the calculation of isovist is most often used as a 2-dimensional one. The single isovist is computed by projecting a series of vectors from the point and observing where the vectors intersect with geometry in the space. These points of intersection are being connected to each other to form the total area of visible space. Among the many possible attributes of a ground plan [2], this article focuses on three measures: area of visual fields, convexity and circularity.

- Area of visual fields (isovist area) expresses the surface of all space visible from all vantage points in the plan. In the isovist literature, distance from an observer's location to a point in the isovist boundary is called a radial. To obtain isovist area size, measured as the square meter area of the isovist polygon, the isovist component breaks the isovist into a number of simpler shapes, such as polygon triangulation. The sum of the area of these simple shapes gives the area of the isovist. The control of the number of simple shapes, that is the accuracy of the calculation, is possible by determining the number of radials. Isovist area evaluates the spacious or narrow qualities of a place. In a narrow area, shorter radials are available to the observer's position producing a sense of insecurity, and vice versa [4]. Each isovist will have its own area value, and the merging of the areas of these surface shapes generated from each point gives the total area of the visual fields.
- Convexity assesses whether the isovist has a convex shape at the generating place [3]. An isovist with convexity equal to or approximate to 1 is more integrated and usually refers to places with regular shape. On the contrary, an isovist with convexity close to 0 has more occluding edges, and such places tend to be fragmented.
- Circularity estimates the roundness of space. An isovist with higher circularity indicates it is more compact and closer to a round shape [5]. The circularity also ranges from 0 to 1. An isovist with circularity close to 0 reflects elongated space, while an isovist with circularity close to 1 represents spaces that have similar radial lengths.

These measures are shown to be among the indicative ones in relation to the visibility of architectural or urban spaces by several studies [6-8]. In addition, they correlate well with a number of other geometric values [9] such as perimeter and connectivity (correlate with the area), dispersion (correlates with circularity), etc.

The isovist fields are applied and analyzed firstly on the existing layouts of market stalls of two city markets – Limanska Market and Futoška Market in Novi Sad. These markets have approximately similar surface sizes, but different shapes, as well as a different number of market stalls and ways of setting them up. The percentage of area occupied by market stalls at the Limanska Market is 23,54% and at the Futoška Market 18,41%. After analyzing the current situation, an experimental scenario was performed where the approximate shape of the layout of the Futoška Market was applied to the floor plan of the Limanska Market, and vice versa. In both cases, the existing number of stalls was retained, and thus the existing percentage of occupied space. The aim of using the experimental scenario is to show that a change in the visual-spatial quality of the market space, which is caused by a change of the layout of the stalls, is measurable. In that sense, additional work could be done on its optimization.

3. RESULTS AND DISCUSSION

Visibility analysis using isovist fields involves generating a regular network where isovist is calculated for each point in this network. The properties of these multiple isovists can then be represented by giving different colors to the grid points. For this work, a grid cell size of 0.1m was adopted and it has been used in all analyzes. In each field of the grid, one central point is defined as a vantage point from which the isovist area is measured. Based on the obtained values, each field of the grid is assigned with a certain color. Points that are closer to blue in visualization results in this paper refer to low values of the isovist area measured by square meter, and points that gravitate to red refer to high values. Other input parameters, such as viewing range, viewing angle and precision, are required to run isovist analysis. The adopted value for viewing range is 50 m, for the viewing angle 360 degrees and for the precision 360 radial rays. Figures 1 and 2 show the results of the analysis for the isovist area property of the existing condition of the Limanska and Futoška markets, respectively. Figure 3 shows the results of the analysis for the isovist area property for the new layout of stalls of the Limanska Market modeled on the existing layout of the Futoška Market.

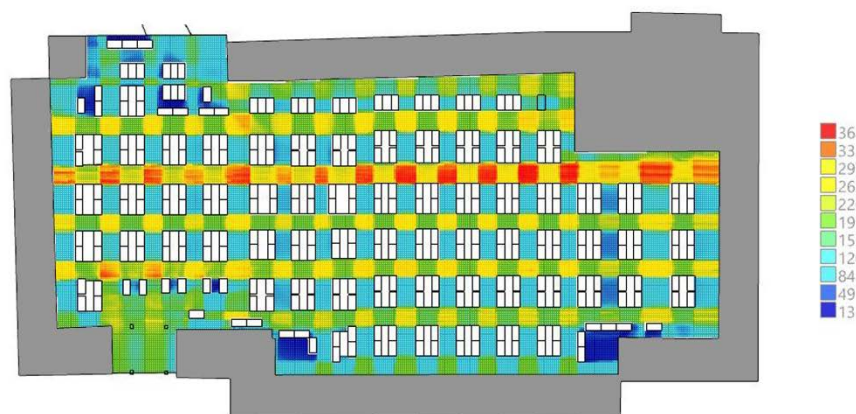

Figure 1. The results of the analysis for the isovist area for the existing layout of the Limanska Market measured in square meters



Figure 2. The results of the analysis for the isovist area for the experimental layout of the Futoška Market measured in square meters

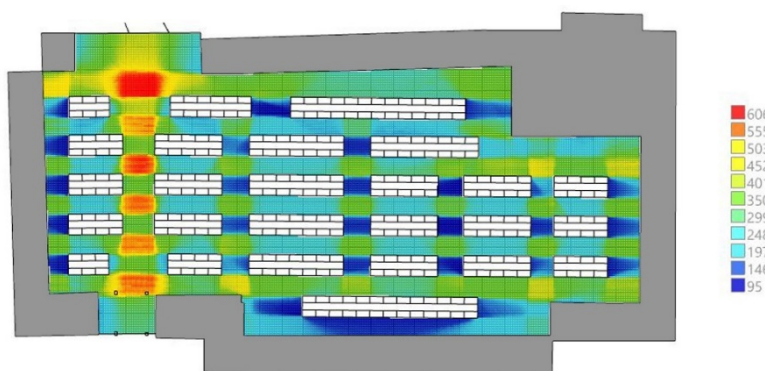

Figure 3. The results of the analysis for the isovist area for the existing layout of the Limanska Market measured in square meters

By the same logic, Figure 4 shows the results of the analysis of the isovist area property for the new layout of the stalls of the Futoška Market modeled on the existing layout of the Limanska Market.

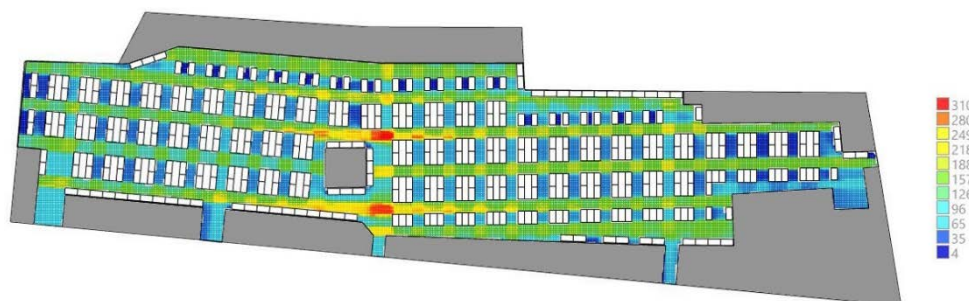

Figure 4. The results of the analysis for the isovist area for the experimental layout of the Futoška Market measured in square meters

To evaluate a spatial configuration based on isovist fields we used average values (μ), the standard deviation (σ), as well as the coefficient of variation (CV) of the three selected isovist properties: isovist area, convexity, and circularity. Table 1 shows the existing and new results for the Limanska Market, and Table 2 provides the same data for the Futoška Market.

Table 1. Results of analysis for the existing and the experimental layout of market stalls at the Limanska Market

Limanska Market	Existing layout			Experimental layout		
	μ	σ	CV	μ	σ	CV
Isovist area (m ²)	179,8672	75,5044	0,4198	296,4935	100,1461	0,3378
Convexity	0,3610	0,1747	0,4839	0,4493	0,1754	0,3905
Circularity	0,4159	0,1131	0,2720	0,4403	0,2165	0,4918

Table 2. Results of analysis for the existing and the experimental layout of market stalls at the Futoška Market

Futoška Market	Existing layout			Experimental layout		
	μ	σ	CV	μ	σ	CV
Isovist area (m ²)	220,2232	79,0899	0,3591	121,3204	57,3507	0,4727
Convexity	0,4565	0,1849	0,4050	0,3893	0,1799	0,4621
Circularity	0,3894	0,1278	0,3283	0,3973	0,1143	0,2877

According to the data from the tables, it is noticeable that there are differences in the results for the existing and experimental layout of the market stalls. The results of the analysis for the Limanska Market show a significantly higher value of the isovist area in the experimental layout compared to

the existing one. The data that additionally speaks in favor of this improvement is the coefficient of variation of the values of the isovist area of the experimental layout which is 0.8 times less than the variability of the values of the isovist area of the existing layout. A lower coefficient of variability indicates smaller deviations of all analyzed values from the mean value. Convexity for the experimental layout was increased 1.2 times compared to the existing one, also with reduced variability. For circularity at the experimental layout, it can be stated that it has retained approximately the same value, with a slight decrease of 0.94 times.

The results of the analysis for the Futoška Market show a decrease in the values of isovist area and convexity in the experimental layout of 0.6 and 0.9 times, respectively. This was followed by a simultaneous increase in variability of 1.3 and 1.1 times for mentioned visual properties, respectively. When it comes to circularity, it can be stated that there was a slight increase of 1.02 times in the experimental layout. Figure 5 shows a comparison of the results between the Limanska and Futoška markets for all three analyzed attributes

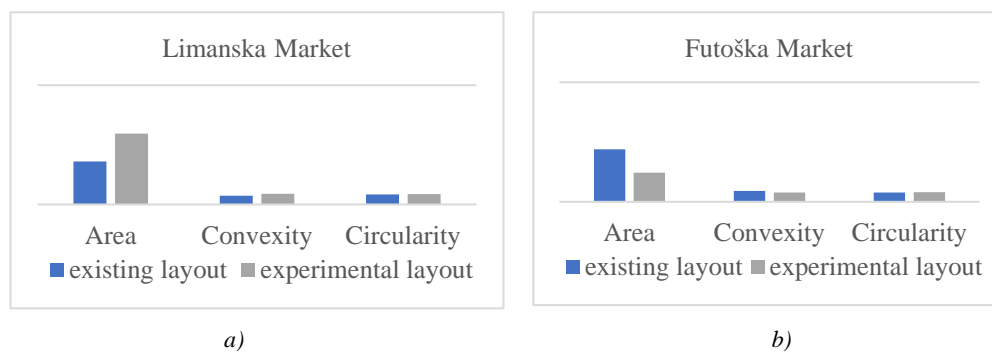

Figure 5. The comparison of the results of the mean values of the area, convexity, and circularity between the existing and experimental layout for a) the Limanska Market b) the Futoška Market

Based on the results of the comparison it can be concluded that the existing layout in the Futoška Market has better characteristics in terms of isovist area and convexity. On the other hand, the visual characteristics of the Limanska Market were improved by the experimental layout of the stalls regarding isovist area and convexity. Differences in circularity values were found to be negligible in both analyzes. To summarize, the existing layout of market stalls at the Futoška Market is better compared to the layout at the Limanska Market in relation to the analyzed visual characteristics. A visual simulation of each of the three attributes calculated for each layout takes approximately 120 seconds.

In addition, an analysis of different layouts with a different grouping of market stalls was conducted on the example of the Limanska Market. We considered three situations in which the stalls were first grouped in pairs next to each other in a row, then four in a row, and finally eight in a row. Since the stalls require functional space for the vendors, it was decided to overlap the functional spaces of the formed groups, so that the rows of stalls were placed in parallel. Thus, clusters of four, eight, and sixteen stalls were obtained, which define the shape of the circulating space. By overlapping the functional spaces of the stalls the circulating space is increased.

Apart from grouping the stalls, their orientation was also taken into account. They were placed first in the east-west direction, and then in the north-south direction. Thus, six layouts for three groups of stalls were obtained and analyzed. A total of 288 stalls were used for all six examples. This number of stalls could not be organized individually (without grouping) with a functional space between them. Visibility analyzes were performed with the same input parameters as previously performed and described analyzes.

Figures 6, 7, and 8 show the results of the analysis of the isovist area property for the layouts composed of the market stalls grouped by two in a row, four in a row, and eight in a row, respectively with two types of orientation.

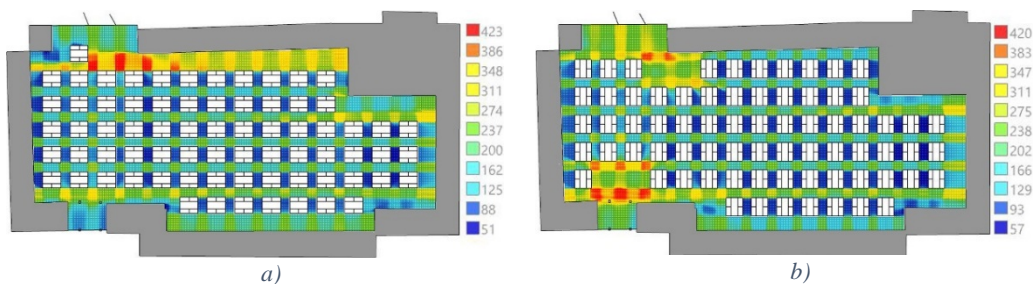

Figure 6. The results of the analysis for the isovist area measured in square meters for the layout composed of rows of 2 stalls at the Limanska Market with a) an east-west orientation b) a north-south orientation.

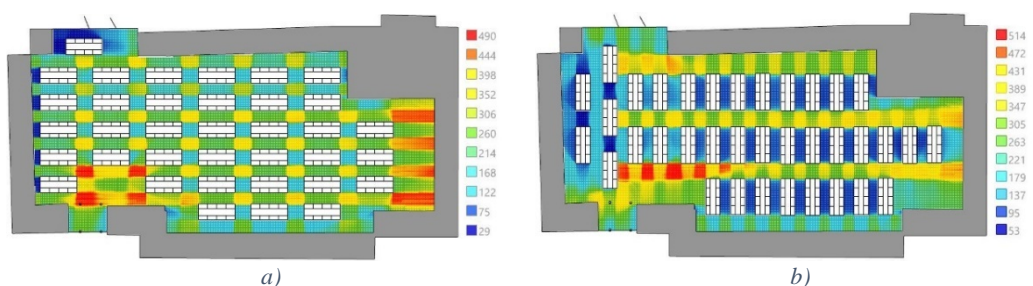

Figure 7. The results of the analysis for the isovist area measured in square meters for the layout composed of rows of 4 stalls at the Limanska Market with a) an east-west orientation b) a north-south orientation.

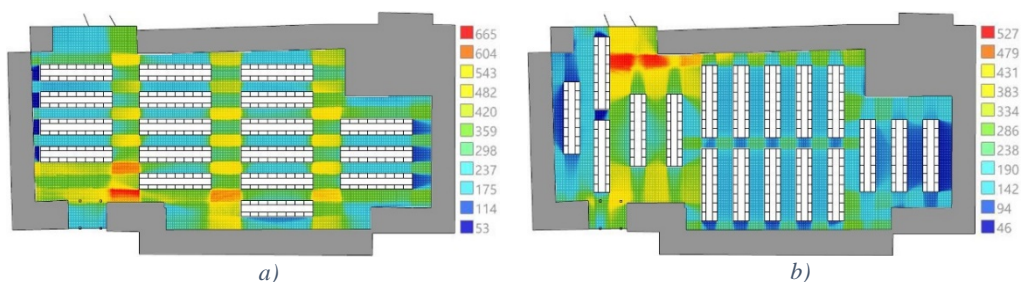

Figure 8. The results of the analysis for the isovist area measured in square meters for the layout composed of rows of 4 stalls at the Limanska Market with a) an east-west orientation b) a north-south orientation.

Table 3 shows the results obtained for all six layouts. Since the differences in values of convexity and circularity are insignificant compared to the differences in values of the isovist area, only the values for isovist areas are shown in the table for easier comparison.

Table 3. Results of isovist area analysis for the six layouts of differently grouped and oriented market stalls at the Limanska Market

Isovist area (m ²)	East-west orientation			North-south orientation		
	μ	σ	CV	μ	σ	CV
Groups of 2 stalls in a row	196,6031	78,6031	0,3998	194,9475	77,4199	0,3971
Group of 4 stalls in a row	259,2570	92,0482	0,3550	250,2087	111,1209	0,4441
Group of 8 stalls in a row	324,0892	110,5334	0,3411	218,7052	97,0380	0,4437

According to the data from the table, it is noticeable that there are differences in the results for all six layouts. The difference between east-west and north-south-oriented layouts is insignificant in the first case, for a group of 2 stalls in a row, but it is noticeable that it increases with the number of grouped stalls. In all three cases, the east-west orientation showed better isovist area results which

can be related to the larger dimension of the market building which is in the same direction. On the other hand, the increase in the number of grouped stalls has also led to an increase in the value of the isovist area. This can be explained by the larger interspace that occurs when the stalls are joined in a row. This analysis confirms the assumption that different grouping of stalls, their orientation, as well as the shape and width of the interspace, have an impact on visibility results. These results can be further improved because there are numerous possibilities for grouping stalls as well as their mutual combinations.

4. CONCLUSION

The results presented in this paper show that the applied approach is highly applicable for improving visual qualities of the inner space of the city market. It has been shown that the ability of the isovist analysis as a tool to examine how to set up market stalls and to help make decisions when choosing layout is justified.

The visibility analysis presented in this paper refers only to the 2D environment, but since market stalls generally have the same uniform heights, in this paper, this should not be understood as an essential limitation. There are other limitations in the research that should be mentioned. The paper does not take into account social and dynamic aspects such as the presence and movement of people, which can also be an obstacle to perceiving space depending on the extent to which it is occupied.

This research primarily studied impacts of the overall shape and layout of market stalls on visibility at every point of space for customers. Additional design parameters which could have an effect on the quality of visibility should be identified and studied, such as: the shape and width of circulation space between market stalls; dimensions of the exhibition parts of the market stalls; possible positions of observers during movement through space; the position and the distance between stalls with the types of products that are likely to be purchased during the same visit to the market, and similar.

Future studies are encouraged to examine the use of isovist analysis as a tool that can contribute to improving the quality of visual characteristics in architectural and urban environments.

ACKNOWLEDGEMENT

This research has been supported by the Ministry of Education, Science and Technological Development through project no. 451-03-9/2021-14/200156: "Innovative scientific and artistic research from the FTS domain".

LITERATURE

- [1] L.S. Davis and M. L. Benedikt, "Computational models of space: Isovists and isovist fields," *Computer Graphics and Image Processing*, vol. 11, no.1, pp. 49-72, 1979.
- [2] M.L. Benedikt, "To take hold of space: isovists and isovist view fields," *Environment and Planning B: Planning and Design*, vol. 6, no.1, pp. 47-65, 1979.
- [3] A. Turner, M. Doxa, D. O'Sullivan and A. Penn, "From isovist to visibility graphs: a methodology for the analysis of architectural space," *Environment and Planning B: Planning and Design*, vol. 28, pp. 103-121, 2001.
- [4] A.E. Stamps III, "Isovists, enclosure, and permeability theory," *Environment and Planning B: Planning and Design*, vol. 32, pp. 735-762, 2005.
- [5] M. Batty, "Exploring isovist fields: space and shape in architectural and urban morphology," *Environment and Planning B: Planning and Design*, vol. 28, pp. 123-150, 2001.
- [6] M.J. Ostwald and M. Dawes, "Using Isovists to Analyse Architecture: Methodological Considerations and New Approaches," *The International Journal of the Constructed Environment*, vol. 3, no. 1, pp. 85-106, 2013.
- [7] K. Hadi and C. Zimring, "Design to Improve Visibility: Impact of Corridor Width and Unit Shape," *Health Environments Research & Design Journal*, vol. 9, no. 4, pp. 35-49, 2016.
- [8] E. Morello and C. Ratti, "A digital image of the city: 3D isovists in Lynch's urban analysis," *Environment and Planning B: Planning and Design*, vol. 36, pp. 837-853, 2009.
- [9] R. Conroy. "Spatial navigation in immersive virtual environments." Doctoral thesis (Ph.D), The Faculty of the Built Environment, University of London, UK, pp. 157, 2001



Vladana Petrović, University of Niš, s.vladana@gmail.com
Nataša Petković Grozdanović, University of Niš, natasapetkovic83@gmail.com
Hristina Krstić, University of Niš, hristinaa@hotmail.com
Branislava Stoiljković, University of Niš, branislava.p.stoiljkovic@gmail.com
Milica Živković, University of Niš, milicaclassroom@gmail.com

SPATIAL-FUNCTIONAL DEVELOPMENT OF SALON APARTMENT IN SERBIA

Abstract

The salon apartment is a residential typology that developed in Serbia from the middle of the 19th century until the beginning of the Second World War. The spatial-functional organization of the salon apartment is characterized by typological characteristics such as: division of space into two zones, salon, central room, pass-through dining room, etc. These characteristics have been developed according to oriental and western European influences. The paper will investigate the development, organization and typology of salon apartments in Serbia.

Keywords: salon apartment, salon, central room, pass-through dining room

ПРОСТОРНО-ФУНКЦИОНАЛНИ РАЗВОЈ САЛОНСКОГ СТАНА У СРБИЈИ

Сажетак

Салонски стан представља стамбену типологију која се у Србији развијала од средине 19. века до почетка Другог светског рата. Просторно-функционалну организацију салонског стана карактеришу типолошке карактеристике као што су: подела простора на две зоне, салон, централна просторија, пролазна трпезарија и др. Наведене карактеристике су развијане према оријенталним и западноевропским утицајима. У раду ће бити истраживан развој, организација и типологија салонског стана у Србији.

Keywords: салонски стан, салон, централна просторија, пролазна трпезарија

1. INTRODUCTION

The spatial-functional organization of the "apartment with a salon" is a housing organization whose implementation in Serbia first started in the 19th century. The development of this housing typology began together with the adoption of new economic, social and social norms, which were established after the liberation from the Turks. By rejecting oriental influences and adopting Western European housing models, new spatial patterns were transferred, which led to the functional development of the salon apartment. As a functional model, it was used in Serbia until the beginning of the Second World War, but after the establishment of new social conditions after the war, only some of its elements were implemented. The paper investigates the development and typology of the spatial-functional organization of a salon apartment in Serbia.

2. DEVELOPMENTAL CHARACTERISTICS OF THE SALON APARTMENT

In Serbian housing architecture, the development of functional organization of the apartment, according to theoretical and professional considerations, began in the 19th century and is based on the spatial development of apartments in Europe with simultaneous oriental influences. The housing typology that appeared in the 19th century and whose development continued until the middle of the 20th century, is characterized by certain established patterns of spatial organization that were transferred from Western European housing models. Almost the same principle of spatial organization was applied in France, Germany, Austria (Figure 1). This typological model is characterized by the following functional characteristics: design of the salon, central rooms as the core of the apartment, separation of the household zone from the main/residential zone of the apartment.



Figure 1. (a,b,c). Salon apartments in Berlin, Paris and Stockholm

a) Residential building in Berlin (1893), Alfred Messel 24 Kurfürstendamm, Berlin

b) Rent building in Paris (1900), Alfred Fasquelle Avenue des Champs-Élysées, Paris

c) Rent building in Stockholm (1894–96) A. Johansson

(Source (a,b): Klahr D. (2011) *Luxury Apartments with a Tenement Heart*. *The Journal of the Society of Architectural Historians* 70(3):290-307,

c) <https://journal.eahn.org/articles/10.5334/ah.343/>)

The original functional characteristics of the apartment in Serbia, according to B. Nestorović, was based on the central plan of the organization, in which the central position was occupied by a room, defined as the core of the apartment, while all other main and auxiliary rooms were grouped around the central room. In its initial phase of development in Serbia, the central room had the function of an entrance space, i.e. a hall from which all other rooms were accessed. In the later period of development, the entrance hall evolved into a centrally designed dining room (Figure 2).

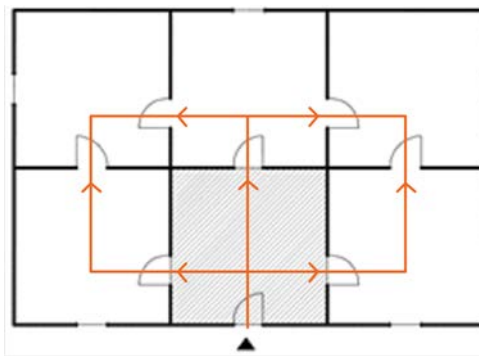

Figure 2. Central plan of spatial organization

New developmental changes took place in the middle of the 19th century, when a new spatial characteristic called a salon began to appear in the functional organization of the apartment. In the Western European housing typology, the spatial-functional concept of apartments designed with a "European salon" is related to France and Italy, from where it was further transferred to other countries [1]. According to *D. Alfrević*, "the term salon was first used in France around the middle of the 17th century (1664) and originates from the Italian word *sala*, which means a large reception area in Italian villas. Although the term is most often associated with literary gatherings that were characteristic of French bourgeois society, it is generally accepted that salons have been in use since the early 16th century (in Italy) until the mid-19th century (in France). In a narrower sense, the term is related to a representative space that serves for sitting, gathering and receiving guests in a residential space"[2]. The emergence of the salon, as a representative space for the reception of guests in the residential architecture of the XIX and XX centuries, defined the characteristic spatial and functional organization of the living space called the salon apartment.

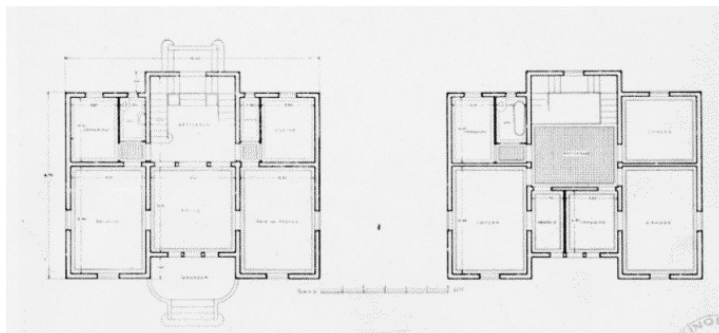

Figure 3. Plan of an Italian villa of 19th century with the designed salon and central spatial organization plan (Source: <https://amshistorica.unibo.it/164>)

In the architecture in Serbia, the salon design began being applied at the time of the creation of the new bourgeois class that emerged after the liberation from the Turks. The adoption of European housing models has led to the transfer and development of the spatial Western European concept of housing which includes a salon in its spatial structure. As a spatial concept, it was transferred at the end of the 19th century by Serbian architects educated at Western European universities. The design of the salon was a characteristic of the housing organization of family houses, and later apartments of the upper bourgeois class up to the Second World War. In parallel with the European characteristics, the spatial-functional development of the apartment was influenced by the oriental housing models. According to oriental-Turkish influences, the basis of development was the central space for receiving guests, called *the sofa*, which in traditional oriental culture served as a gathering place for men. The central room is the core of the apartment and was defined as a "Turkish salon or sofa", which, unlike the Western concept, had an introverted gathering function for the reception and enjoyment of hosts and guests and was exclusively for gathering men (Figure 4) [2]. In the newly formed bourgeoisie, the function of the salon in its initial form was traditionally influenced by the introverted function of the Turkish sofa, and then, taking over the function of European salons, it became a space for socializing of intellectually compatible participants, men and women.

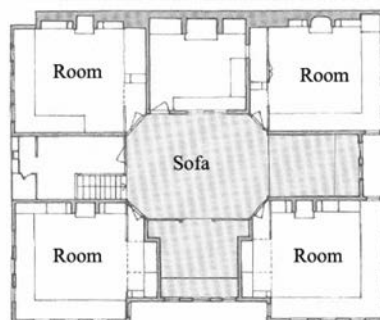

Figure 4. Plan of the oriental house with the "sofa" as a centrally designed room which served as a center for entertaining guests (Source: Güleç, S. A., Canan, F., & Korumaz, M. (2006). Analysis of the units contributing climate comfort conditions in outdoor spaces in Turkish traditional architecture. In PLEA 2006 Conference. pp. 103-110).

One of the most significant changes in the functional organization of the salon apartment in Serbia, occurred in the period between the two world wars. During this period, the central room, which has the function of an entrance hall and the main communication, was transformed into a centrally designed dining room. The positioning of the dining room in the center of the apartment, in the function of extended communication, was taken over from the Berlin structure of apartments from the 19th century, which is why it was called the "Berlin Room" (Figure 5). The "Berlin Room" was a central space that connected the salon rooms with bedrooms, utility rooms and service rooms, which were usually designed in the wing of the apartment facing the courtyard. This room functioned as a spacious hallway and as a dining room where the family gathered. As a spatial concept, it became common in the concept of the bourgeois apartment in the early 19th century because new bourgeois ideals were created through it - informal social interaction and close family ties. When the wave of immigrants came to Berlin in the mid-19th century, the city underwent an urban transformation with the construction of multi-storey, rented apartment buildings. In the rush of Berlin construction, the municipal officer Gustav Assmann, made a series of designs that would serve as guides for the design of apartments of the lower and middle Berlin social class. However, these designs did not have a new typology developed, but represented a reduced version of the bourgeois apartment. As part of the apartments designed for the lower strata of society, the *Berlin Room* remained the core of the apartment, becoming an instrument of a conservative social reform and was considered the last trace of premodern German family life [3]. The structure of the apartment with the Berlin room was developed as a typology of apartments throughout Europe, but the *Berlin Room* in its form appeared in Serbia only after the First World War. As a functional concept, it was very important for its capacity to maximize the use of narrow building plots. Also, the side courtyard wings could be designed without closed skylights, which was in accordance with the regulations of the time [4].

In the professional literature, the term "*Belgrade apartment*" is defined in a large number of contemporary literature for the organizational scheme of housing applied in the interwar period, which includes a salon and a centrally designed dining room. However, as a typological organization, it was not exclusively related to Belgrade, but had its application throughout Europe.

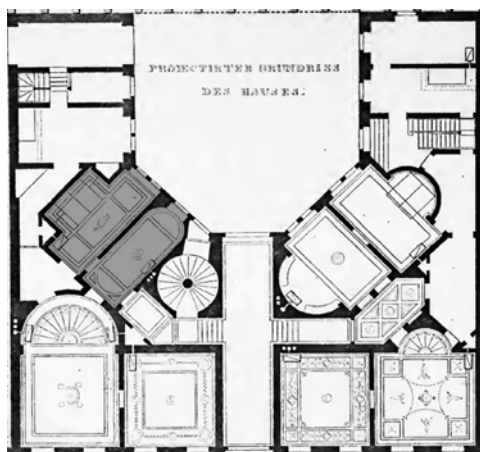

Figure 5. Floor plan of a residential building from Berlin with a designed "Berlin room" (beginning of 19th century) (Source: Rousset, I. (2017). *The Berlin Room. The Journal of Architecture*, 22(7), pp. 1202–1229)

At the end of the 19th century and the beginning of the 20th century, another significant change took place in the housing organization and the way of living. The emergence of water supply and sewerage in the cities led to the design of a new group of rooms, sanitary rooms, toilets and bathrooms, which represented a significant spatial development and improvement of housing. The created sanitary rooms in the apartment were at the same time grouped as a group of rooms with utilities. In the spatial organization, there was a development of the plan with a series of smaller and larger rooms that were differentiated by size. In addition to rooms and kitchens, there were pantries, bathrooms, hallways, side entrances, so that it has the simple layout with rooms of similar dimensions, the living space became distinctly divided into groups of rooms for living and service. From that moment, a new type of apartment evolving to this day was created.

2.1. TYPES OF FUNCTIONAL ORGANIZATION OF SALON APARTMENT

The functional concept of the salon apartment, from its appearance in our environment, until the end of its application as a unique typology, is characterized by established spatial patterns, which according to *M. Bajlon and D. Mecanov*, can be reduced to three basic types of organization:

- Central;
- Longitudinal;
- Combined [5,6] .

These types of organization of the housing unit are directly related to urban conditions, i.e., according to the disposition of the designed building in the urban block. According to *A. Keković*, the classification of structures according to the following typology can be performed:

- Freestanding buildings;
- Semi-detached buildings;
- Interpolated buildings which can be divided into:
 - a) narrow street front interpolations,
 - b) wide street front interpolations;
- Buildings on the corner of an urban block [7].

2.1.1. Central plan of organization of the salon apartment

The central plan is based on a spatial housing organization, according to which the central position is occupied by a pass-through dining room. According to the position of the central room, other main rooms are grouped. Auxiliary rooms are grouped within the auxiliary block. The following subtypes can be observed within this type:

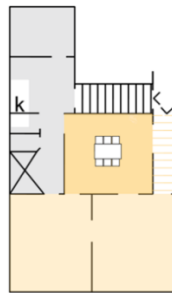

Figure 6. Schematic representation of the first type of central organization of the apartment (Author's review according to the source: Bajlon, M. (1980). Apartment in Belgrade. Postgraduate Studies, Course - Housing Materials, Volume 54. Belgrade: Faculty of Architecture, University of Belgrade, pg. 6-9)

2.1.2. Longitudinal plan of organization of the salon apartment

This organization of the salon apartment is based on the linear organization of the space, according to which the main and auxiliary zones of the apartment are connected by a linear connection. This approach to the organization was characteristic in the design of interpolated buildings on narrow building plots and was a very commonly used type. In the organizational scheme, the functional pattern of the salon apartment with a centrally designed dining room has been retained. The living quarters are designed towards the street, while the household zone is connected to the dining room and positioned towards the yard. The main and auxiliary entrances to the residential zones are separated. The main zone was accessed from the main staircase, while the auxiliary zone was accessed via a terrace or a specially designed staircase (Scheme 4).

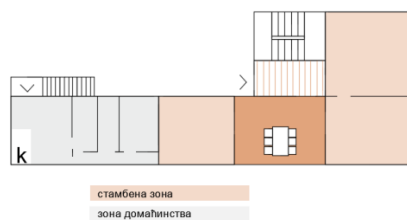

Figure 7. Schematic representation of the longitudinal organization of the apartment (Author's review according to the source: Bajlon, M. (1980). Apartment in Belgrade. Postgraduate Studies, Course - Housing Materials, Volume 54. Belgrade: Faculty of Architecture, University of Belgrade, pg. 6-9)

2.1.3. Combined plan of organization

The combined plan for the organization of a salon apartment is the third type of organization based on a combination of all the above mentioned elements. As a functional concept, it was most often applied to free-standing buildings or interpolations with a wide façade front, where there was a potential for a larger development of the living space. It is characterized by a centrally designed dining room with the function of the main communication, while the living room and other living areas are developed and grouped around the central room (Scheme 5).

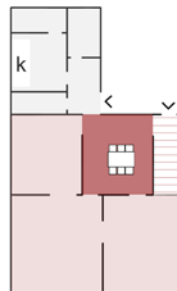

Figure 8. Presentation of the combined type of salon apartment organization (Author's review according to the source: Bajlon, M. (1980). Apartment in Belgrade. Postgraduate Studies, Course - Housing Materials, Volume 54. Belgrade: Faculty of Architecture, University of Belgrade, pg. 6-9)

3. SPATIAL-FUNCTIONAL ORGANIZATION OF THE SALON APARTMENT

The spatial-functional organization of the salon apartment space is based on the monocentric organization, which includes grouping the rooms around the central room, which originally represented the entrance space - hall and which was directly connected to the salon as the most representative room in the apartment. The structure of salon apartments is characterized by its "established patterns of organization" [8], which include (Figure 29):

- Clear division of the apartment space into two functional zones, residential/main and service zone
- The main zone includes: central room/dining room, salon, rest rooms, cabinet;
- Auxiliary zone includes auxiliary rooms: kitchen, pantry, service room, or maid's room, storage and sanitary facilities;
- The service zone is functionally separated from the main zone of the apartment and designed towards the yard;
- Designed two entrances to the apartment, the main and service;
- The main entrance leads to the residential area. It was used for apartment owners and guests;
- The service entrance leads to the household area. It is physically separated from the main zone and used as a service entrance;
- The connection of the central room with the service zone was realized through the designed annex;
- The central room is the main entrance area from which all other rooms are accessed. With its position, it divides the space into main and auxiliary zones;
- European salon model, is a state room for entertaining guests. In daily activities, it assumed the function of the living room.
- Bedrooms belong to the group of intimate rooms. They are designed towards the street and interconnected. The bedrooms are entered from the central room.
- The kitchen is designed as a separate room and positioned in the service area;
- The pantry is designed next to the kitchen, in the apartments of a larger structure, two pantries are designed;
- The preparation room appeared as a space in front of the entrance to the dining room in order to prepare for laying the table. In the preparation room were accessories for laying the dining table
- The "Maiden's Room" figured as a room for the service staff of the family; it is designed within the service zone and is directly connected to the kitchen;
- The toilet and the bathroom formed a sanitary block, connected by a hallway with other rooms. The toilet was functionally separated from the bathroom;
- The laundry room was most often positioned in the attic and with access to the roof terrace where the laundry was dried [9]

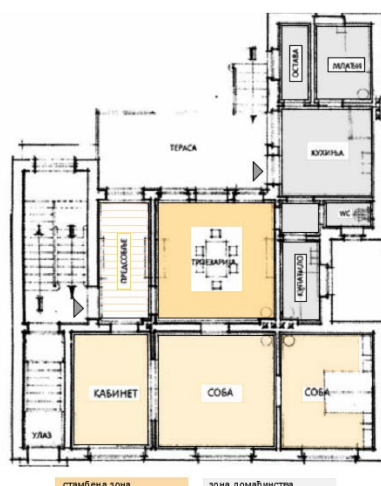

Figure 9. *Spatial-functional concept of a salon apartment in the interwar period - Osvald Repić Building (1933), Borivoja Gojkovića 4, Niš, arch. Julian Djupon (Source: Keković, A. (2009). Residential architecture of Niš in the Moderna movement between the two world wars (Doctoral dissertation, University of Niš, Faculty of Civil Engineering and Architecture). Pg.78-79)*

In the development phase, between the two world wars, the central room took over the function of a centrally positioned dining room, which also became the main communication in the apartment, directly connected to the living room and bedrooms and connected to the kitchen block via the annex. With its position, the central dining room took over the primary function of gathering the family at the dining table, while at the same time it became the main communication in the apartment. Two types of salon apartment organizations can be distinguished in their development in the Serbian environment. The first type, which represents the first form of a salon apartment, which appeared in the 19th century and whose organization, in addition to the position of the salon, is characterized by a designed central space with the basic function as a reception space and communication. The second type of the salon apartment is a more developed functional concept, which appeared after WWI. It is characterized by the development of the central room in which the dining room is formed as the main center of family gathering and the retained function of the main communication. With this type, the entrance space is moved and reduced to the "hallway" function.

In both models, the structure of the salon apartment is based on a clear expression of social and spatial division: owners and services, guests and users, daily and festive activities. The mentioned characteristics are reflected in the strict division of the apartment into two zones: the residential-main zone and the service zone. At the same time, the residential zone includes state and intimate rooms of the residents, which, as a rule, are positioned towards the street (salon, bedrooms, cabinets). In the household zone or auxiliary zone, service rooms are grouped (kitchen, pantry, storage, preparation room, maiden's room) and in a later development, a sanitary block. The group of auxiliary rooms is oriented towards the yard and with a designed separate entrance. [9]

4. CONCLUSION

The development of the spatial structure of the salon apartment in Serbia represents the continuity of the development of the structure of European, bourgeois apartments from the 18th and 19th centuries with simultaneous oriental and European influences. According to oriental-Turkish influences, the basis of development was the sofa as a central space for receiving guests, that is, in traditional oriental culture, as a space for gathering men. With the creation of a new bourgeois class after the liberation from the Turks, there is a transfer and development of the spatial, Western European concept of the apartment, which contains a salon in its spatial structure. In the newly formed Serbian bourgeois class, the salon function in its initial form was traditionally influenced by the introverted Turkish sofa function, and then, taking over the function of European salons, it became a space for socializing of intellectually compatible participants, men and women. From the mentioned influences originated the spatial-functional organization of space, which in its structure contains a salon and is called the salon apartment.

The functional characteristic of the salon apartment is based on a monocentric organization, which involves grouping the rooms around the central room, which originally represented the entrance

space - hall and which was directly connected to the salon as the most representative room in the apartment. In its later phase of development, between the two world wars, the central room took over the function of a centrally positioned dining room, which also became the main communication in the apartment, directly connected to the living room and bedrooms and connected to the kitchen block. With its position, the central dining room took over the primary function of gathering the family at the dining table, while at the same time it became the main communication in the apartment. With the advent of water supply and sewerage, a new group of rooms, toilets and bathrooms was designed, which represented a significant spatial development and improvement of housing. By creating sanitary rooms in the apartment as a group of rooms with utilities, there is a tendency to concentrate them. In the functional organization, the plan is developed with a series of smaller and larger rooms. In addition to the rooms and kitchen, there is a pantry, bathroom, hallways, side entrances, so that the apartment becomes distinctly divided into groups of rooms for living and service. From this moment, a new type of apartment was created that has been evolving to this day. The disposition in the urban block was an important typological characteristic of residential buildings that influenced the organizational scheme of the apartment. The classification of multi-family buildings, designed in relation to the disposition in the urban block can be performed on the following types

- Freestanding buildings;
- Semi-detached buildings;
- Interpolated buildings divided into:
 - Narrow street front interpolations
 - Wide street front interpolations;
- Buildings on the corner of an urban block.

From the previously mentioned urban conditions, originated the functional organization of the salon apartment, which can be defined as three basic types of organization whose characteristics are based on the position of the building in an urban block, and defined by the shape of the plot:

- central type;
- longitudinal type;
- combined type.

The development of the functional concept of the salon apartment was interrupted in 1941. Post-war conditions of construction imposed new ways and models of housing, of which only certain elements of salon apartments continued to be implemented [9]

LITERATURE

- [1] Б. Несторовић, *Увод у архитектуру*. Завод за издавање уџбеника Социјалистичке Републике Србије, Београд, 1967, стр. 114.
- [2] Ђ. Алфировић, С. Симоновић Алфировић, „'Салонски' стан између два светска рата у Србији: Преиспитивање оправданости коришћења термина”. *Архитектура и урбанизам*, 44, стр. 7–13, 2017.
- [3] I. Rousset, „The Berlin Room“, *The Journal of Architecture* vol. 22(7), pp.1202-1229, 2017.
- [4] М. Бајлон, *Стан у Београду*. Последипломске студије, Курс – Становање Материјали, Свеска 54 Београд: Архитеконски факултет, Универзитет у Београду, 1980, стр. 6–9.
- [5] Мечанов, Д. (2010). *Валоризација архитектуре стамбених зграда из периода модерне*. Наслеђе 11, стр. 79–101.
- [6] Б. Несторовић, *Еволуција београдског стана*. стр. 247–270, 1955.
- [7] А. Кековић, З. Чемерић, *Модерна Ниша 1920–1940*. Друштво архитеката Ниша, Ниш, 2006, стр. 127.
- [8] Ђ. Алфировић, С. Симоновић Алфировић, Београдски стан. *Архитектура и урбанизам* 38, стр. 41–47, 2013
- [9] В. Петровић, *Развој и типологије вишепородичног становања Ниша од 1918. до данас*. Докторска дисертација. Грађевинско-архитектонски факултет, Универзитет у Нишу. стр. 31-32, 48-49, 2021.



Nataša Petković Grozdanović, University of Niš, natasapetkovic83@gmail.com

Branislava Stoilković, University of Niš, branislava.stoilkovic@gaf.ni.ac.rs

Slaviša Kondić, University of Niš, slavisa.kondic@gaf.ni.ac.rs

Katarina Medar, University of Niš, katarinamedar@gmail.com

SPATIAL ARRANGEMENT OF MULTIFAMILY SOCIAL HOUSING – KEY CRITERIA RELEVANT FOR THE QUALITY OF HOUSING

Abstract

In order to ensure the sustainability of social housing, the living conditions should meet basic biological needs [demands], but they should also have a stimulating effect on the psycho-social development of the users. The focus of the research is on identification and definition of the physical and spatial criteria that are essential for the quality and sustainability of this type of housing in order to distinguish the dwelling layouts [housing models] that can be considered appropriate for the specific requirements of social housing,

Keywords: housing quality, internal space, multifamily housing, social housing, spatial criteria

ПРОСТОРНА ОРГАНИЗАЦИЈА АРХИТЕКТОНСКОГ СКЛОПА ВИШЕПОРОДИЧНИХ ОБЈЕКТА СОЦИЈАЛНОГ СТАНОВАЊА – КЉУЧНИ КРИТЕРИЈУМИ РЕЛЕВАНТИ ЗА КВАЛИТЕТ СТАНОВАЊА

Сажетак

Да би се обезбедила одрживост социјалног становања, услови становања у објектима овог типа треба да задовоље не само основне биолошке потребе, већ да делују стимулативно и подстицајно на психо-социјални развој корисника. Како би се од великог броја различитих стамбених образаца издвојили они који се по својим карактеристикама могу сматрати одговарајућим за специфичне захтеве социјалног становања, фокус истраживања је на идентификацији и дефинисању просторно-физичких чиниоца који су од суштинског значаја за квалитет и одрживост овог типа становања.

Кључне ријечи: квалитет становања, организација архитектонског склопа, социјално становање, просторни критеријуми

1. INTRODUCTION

The character of an apartment building internal space – how it is planned, developed and organized – is a determinant that directly defines the quality of people's daily life, safety and well-being [1]. Therefore, it is not surprising that considerations in contemporary social housing practice are increasingly focused on the improvement of relations between spatial and social aspects of this type of housing. The integrated dual approach aims to support the social development of its users through the implementation of physical measures, in order to ensure the global progress.

The subject of this research is the improvement and innovation of the architectural methodology for planning and design of multifamily social housing, with a focus on spatial characteristics, organization and layout of the overall internal space. The aim of such research is to improve the housing qualities in this type of facilities – physical, as long well as social ones.

The overall internal space, observed as a spatial level in the process of architectural design, has been taken as the subject of the research, given its poor representation in the scientific and professional frameworks for the development of multifamily social housing. Namely, architectural researches conducted upon the quality of social housing are mainly based on the aspects of the unit's quality. Very little attention has been paid to the analysis of the spatial organization of the overall layout of the internal building space. Since “apartments get their true meaning and value only in the relations with the whole” [2], they cannot be physically and functionally observed as isolated elements and thus cannot be designed independently from the building to which they belong.

2. SPECIFIC REQUIREMENTS OF MULTIFAMILY SOCIAL HOUSING AND THEIR RELATIONS TO THE BUILDING SPATIAL ORGANIZATION

Bearing in mind the specificities of social housing users and circumstances of using of this type of facilities, the organization of the internal space of multifamily (apartment) building should respond to the increased needs for: *privacy* [3] [4] [5], *socialization* [4] [5] [6] and *user affiliation* [4] [5] [6]. Each of these needs will be examined in greater detail through the relationship between the physical environment and its impact on the quality of social housing.

Privacy. "As a social beings, humans need interactions, but as individuals and sensible beings we want to decide, when and under which conditions we want to do it" [7]. In terms of privacy, individual family housing provides far greater comfort, since tenants also possess “their own piece of land” [8].

However, in the case of social housing, the multi-family housing schemes are more often applicable, as they are more economically efficient. In multifamily social housing, in most of the cases, the users have authority only upon their apartment.

In order to improve the quality of this type of housing, it is necessary to implement architectural and design measures that would improve privacy. The basic measures are reflected in the *limitation of the number of apartment units per floor* and *manner of the organization of communication space*, which both can greatly contribute to the improvement of privacy [3] [8].

Security. The reduced level of security within the residential areas intended for multi-family social housing is to some extent related to the way of the spatial organization of the building space [3] [9] [5] [10]. As a basic security problem, Newman [3] refers to their weak "defensibility" caused by inadequate architectural and design methodology. As key elements in the organization of the building assembly Newman [3] quotes the choice of typology and the organization and layout of the internal common space. The use of residential typologies characterized by high-rise housing schemes affects the availability and publicity of residential space [3]. Such spatial and social framework favors the emergence of petty crime and vandalism.

In terms of security requirements, a design approach should allow the development of certain psycho-social relationships [2]. Residential buildings need to be designed in such a way that they do not require a special psychological or physical preparation for the users to use it – they should provide easy usage [7]. The number of tenants directly affects the level of security [3]. Therefore, *limiting the number of tenants or apartment units in the building* is very important. Creating perceptual connections to the environment also influences the issue of security. The way the building is organized - *the position and distance of the apartments in relation to the cores of vertical communications and the level of publicity of horizontal communications on the floor can influence the development of favorable psycho-social conditions and give a sense of security to the users* [2] [3] [7].

Socialization. Humans are both individual and social beings and consequently the housing as a human function possesses both physical and social components. For this reason, the spatial layout of social housing must support the socialization of users through the possibility of social interactions [10] [11] [12]. An individual's willingness to engage in social interactions is primarily influenced by the fulfillment of privacy and security requirements [2]. The well-known physical environment and the perception of who may be encountered provide favorable conditions for establishing mutual contacts between the tenants in the immediate housing vicinity and improve the possibility of their socialization. In addition to the willingness to establish social contacts, in the physical sense the *space should also be organized and equipped to allow informal gatherings, through the planning of the facility intended for common activities. These spaces can be planned and designed as outdoor areas, but they also need to be planned within the building itself* [5]. As users of social housing are characterized by a very broad demographic background, their needs and preferences regarding the physical character of these spaces can significantly vary from case to case. For these reasons, the shared common areas should be developing as polyvalent space that provides the opportunity for multifunctional use [5]. As users' needs may change over time these spaces need to be conceptualized as flexible [10]. The ability of a space to transform according to the specific needs, as well as to be personalized, results in a high level of its usage value. These areas should be intended not only for social housing tenants but also for residents from the surrounding area, in order to enhance the inclusion and integration of social housing users within a narrower and wider social milieu.

User affiliation. The presence of features that will support the development of social interactions among residents greatly contributes to the social inclusion and the sense of belonging [13]. When planning facilities for social housing, it is necessary to introduce *features that will enable meetings and informal gatherings* [2] [4] [5] [7]. Allowing different demographic profiles of users to participate in shared activities influences cognition and acceptance of diversity and thus facilitates their integration into narrower and wider community [14]. In addition to the tenants themselves, it is desirable that neighbors from the immediate area also use these features. Mixing different economic strata contributes to the prevention of fears and prejudices in wealthier neighbors, but also enhances the life chances of the poorer through a "positive role model" - thus encouraging interaction and fellowship among neighbors.

The sense of belonging of the users also depends on the extent to which they are able to fulfill their cultural needs. For example, for some categories, housing in single-family homes is closer to their tradition, while others are characterized by the multi-generational living. Also there are those whose housing requirements are largely related to the specificity of the lifestyle (such as Roma) [4]. Cultural differences not only affect differences in preferences when it comes to the type of housing, but also in the way of spatial organization of the immediate housing environment [6]. The development of *different physical patterns of apartments and varieties in terms of their size and spatial organization* enables the satisfaction of various socio-cultural needs and thus affects the tenants' dignity and sense of belonging.

3. SPATIAL CRITERIA RELEVANT FOR THE INTERNAL SPACE ORGANIZATION OF MULTIFAMILY SOCIAL HOUSING – GUIDELINES WITH ILLUSTRATIONS

The analysis of the spatial-functional and social framework of social housing indicated that the fulfillment of certain specific requirements, which are related to this type of housing (privacy, security, socialization and users affiliation) may be influenced by the way of the spatial organization of the building assembly. The systematization of the findings resulted in the definition of key spatial criteria, crucial for the quality of multifamily social housing: 1) building design, 2) organization of the internal communication space, 3) distribution of different apartment unit types, 4) flexibility of the space and 5) shared interactional areas.

In the continuation of the paper each of the defined criteria will be analyzed in detail and accompanied by relevant examples (which characterized the high level of achieved quality according to each of the criteria) with graphical illustrations.

3.1. BUILDING DESIGN

The spatial organization of a building design, intended for social housing, has proved to be extremely important for the quality of this type of facilities. The building height, its capacity, the floor spatial arrangement are all elements that greatly influence privacy, security, sense of belonging and

development of inter-personal relationships [3] and can therefore be considered as crucial for the development of social housing.

Building capacity. In order to provide the necessary social conditions for the unobstructed use of facilities intended for social housing, it is primarily necessary to limit the number of housing units per building. From the standpoint of social housing, the capacity per building should be between 20 to 25 apartment units [3].

Building height. Although the use of multi-story buildings affects the economical sustainability of social housing, the increase of the building height is justified only to a limited extent. Namely, the increase in the number of floors reflects in some shortcomings regarding the residential quality [10]. Analyzing the impact of the height, Newman [3] states that increasing the number of floors causes alienation from the terrain, reduces the accessibility to the surrounding common facilities, decreases intensity of their use and diminishes the housing quality. For the development of social housing he recommends the use of low residential structures – up to ground floor and 4 upper floors, in exceptional cases up to 6 upper floors.

Number of apartment units per floor. Limiting the number of apartment units per floor decreases the number of occupants, which increases the privacy and security of the residential space and allows easier identification with the place of residence. However, this type of housing is conditioned by the high demand due to the housing shortage. In an effort to provide as many apartments as possible, the planning of this type of facilities is often characterized by the high capacities, which results in the implementation of the floor schemes with a large number of apartment units per floor. On the other hand – regarding the improvement of social integration, security, privacy and a sense of belonging, housing schemes with a large number of apartments per floor have proven to be inefficient.

1 and 2 apartments per floor schemes, although ensuring the highest quality, are considered cost-ineffective for social housing construction. Therefore, modern concepts of multi-family social housing are generally based on plans with 3, 4 or 5 apartments per floor. 3 apartments per floor schemes are the most practical because of their proximity to the vertical communication core. This setting provides the shortest path to the entrance of the apartments, which improves the security of the premises while reduces the number of occupants per floor and increases privacy [5] [8]. In a design with 4 and 5 apartments per floor, security and privacy issues are somewhat reduced as the distance from the vertical core to the unit increases, as does the number of occupants per floor, but these circumstances have no significant effect on the reduction of the residential quality [5] [8].



Spatial organization of the typical floor plan Organization of one of the segments of the floor plan

Figure 1. *Building assembly - Residential complex in Block 32, Belgrade / MITarh (2007), Belgrade, Serbia,¹*

It is very important to point out that schemes with a larger number of apartment units per floor, while being the most economically viable (because by increasing the number of units per floor a more favorable ratio of housing areas to the gross area is obtained), due to the accompanying negative factors are not recommended for the development of social housing [3]. If the capacities of the site intended for social housing are such to enable the development of significant housing stock, segmentation of the building structure into a larger number of segments is required (Figure 1).

¹ Source: http://www.mitarh.rs/index.php?p=project&project_id=46

3.2. ORGANIZATION OF THE INTERNAL COMMUNICATION SPACE

In terms of planning and design of horizontal communication space, the separation of unit access space on the floor from the vertical core should be implemented wherever is possible. In this way the common space in front of apartment's entrances is intended only for the residents of that specific floor, which significantly improves its character (from public to semi-private) and security.

Also, some organizational schemes of the horizontal communication space are more suitable than others. From the security aspects, gallery and atrium [layouts] have proven to be the most effective since their potential to support social integration and promote a sense of belonging. The advantage of applying the gallery/atrium typology is largely based on their social qualities. These spaces provide greater opportunities for development of social interactions and strengthen neighborly relationships [5] [8]. The gallery access is identified with the image of the street as a common space that encourages contacts. The gallery is attractive as a pedestrian walkway, as an outdoor apartment area suitable for flower-growing and urban agriculture, as a place to sit, rest, or interact with neighbors, and because of the close proximity to the residential units and as a convenient playground space for children [8].

The subsidized housing for young scientists of the University of Belgrade, in the block 32 in New Belgrade, is an example of an atrium building, with glazed gallery access, facing the inner courtyard (except to the southwest, where the gallery extends to the outside) (Figure 2). Orienting the galleries towards the atrium improves the visibility of the surrounding space and intensifies the visual contacts between users, which has a beneficial effect on the security and social interactions. The gallery is divided into 4 segments, so that one segment with the common vertical communication serves 6 apartments per floor. The galleries are well lit and naturally ventilated, and are designed with sufficient width to accommodate some additional activities – leisure, flower growing, children playing and etc.

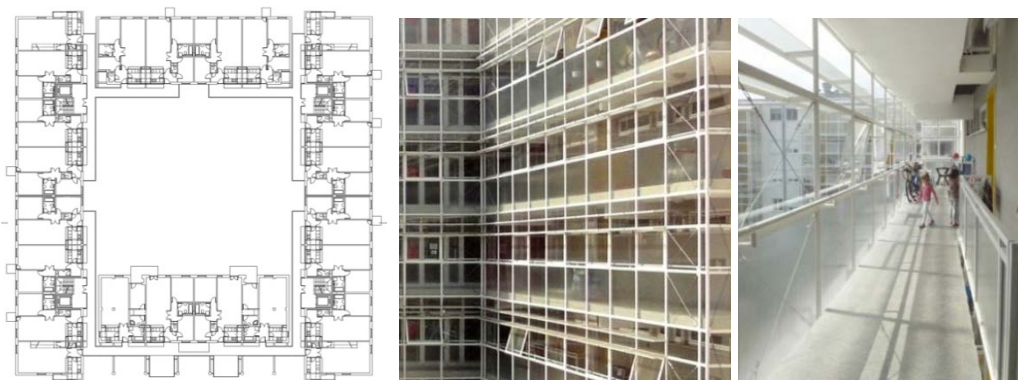

Figure 2. *Organization of the internal communication space - Residential complex in Block 32, Belgrade / MITarh (2007), Belgrade, Serbia* ²

3.3. DISTRIBUTION OF DIFFERENT APARTMENT UNITS TYPES

Different types of apartment units are suitable for different groups of social housing users (singles, developing families, multi-member, multi-generational households, people with disabilities...). By offering a wider range of unit types a large number of different needs can be met. The diversity of apartment units is also necessary in terms of social stability, as demographic complexity promotes social diversity and thus provides a more socially stable environment [15].

This indicates that the planning and construction of multi-family social housing requires the application of various housing unit types, regarding their size, organization and spatial arrangement. As for some households, due to their size or cultural habits, living in single-family homes is more acceptable, whenever it is feasible some units on the ground floor should be designed as house-like apartments – 1) by adding the private entrances and front or back gardens, and/or 2) by developing the housing space with split levels.

One of the significant advantages of the Via Verde social housing in New York is precisely the wide range of apartment units, in terms of their sizes, organizations and arrangements (Figure 3). The lower residential structures, located in the inner part of the plot, are designed to resemble row houses, with access through the associated front garden. The larger, two-level apartments are located within the middle segment of the multi-family building. These apartments are planned as duplexes, with

² Source: http://www.mitarh.rs/index.php?p=project&project_id=46

living and dining area on the access floor and sleeping on the floor located above (or below). The end part of the complex is formed as a residential tower, with single floor apartments of different types, ranging from studios to four-bedroom apartments.



Figure 3. Distribution of different apartment units' types Via Verde / Grimshaw & Dattner Architects (2012), New York, USA³

3.4. FLEXIBILITY

In order to enable the adequate housing conditions for different user profiles and to ensure the sustainability of social housing, organization of the internal space should allow some changes of spatial arrangement. This is very important given that the social housing facilities are publicly owned and that there are no restrictions which would prevent changes of the overall internal space layout. Changes may relate to the modification in terms of: 1) space usage (conversion of non-residential to residential space or vice versa) or 2) units size. Multiple possibilities in the usage of available space capacities, in a way that meets the most diverse needs, affect the efficiency of social housing, improve its quality and economic cost-effectiveness and extend its lifespan. This concept is achieved through the planning of a flexible architectural structure, which supports the introduction of certain changes of the spatial organization and use of the building, thus providing for a higher degree of its variability. Variability is reflected in the possibilities of changing the residential space: 1) at the expense of the surrounding space (increasing the area of the apartment unit by merging two smaller ones, forming two smaller units from one larger, etc.) and/or 2) upgrading the architectural structure.

³ Source: <https://www.archdaily.com/468660/via-verde-dattner-architects-grimshaw-architects>

Some studies indicate that the basic precondition for achieving a high degree of flexibility is the "elasticity" of space [16] [17] [18], which is achieved by: 1) applying a column-beam structural system and 2) grouping technical-installation into cores. The application of such structural system reduces the number of structural elements, thereby influences the development of polyvalent and open residential space [19] and enhances the possibility to customize residential space in terms of the size and organization. In addition, grouping the technical-installation into blocks, within single zones, provides a plenty of free space and thus affects its variability [19].



Figure 4. *Flexibility of internal space - Proposition for social housing Dr. Ivan Ribar Belgrade /Marušić D, Marušić M. (2011) Belgrade, Serbia*⁴

The potential of the flexible internal space organization can be seen in the example of a competition proposal for Dr. Ivan Ribar social housing estate in Belgrade (Figure 4). Due to the utilization of a column-beam structure (with 360cm grid) and linear formation of installation blocks, the development of various apartments' types was possible. By adding a half-module, the basic one-room apartment can be transformed into an apartment with an additional half-room, or by adding the whole module to an apartment with an additional room. By combining (half)modules, it is possible to upgrade apartments in terms of their spatial arrangement (whether in terms of introduction of new units regarding their spatial arrangement or of the change in the percentage representation of existing ones).

⁴ Source: <http://stanovanje.yolasite.com/katalog-stanova.php>

3.5. SHARED INTERACTIONAL AREAS

As has been emphasized before, the existence of space which could support the development of social interactions among social housing users is of great importance for the quality and sustainability of this type of housing. Common spaces are usually planned as shared outdoor spaces. However, in cases where free unbuilt space on the plot is insufficient (due to the application of a high occupancy rates, significant parking areas and etc.) their alternative should be pursued in the development of shared common spaces within the buildings themselves.

It is necessary to provide at least one common space intended for use and gathering of tenants, with a standard of 0.5m² per user. It is necessary to develop these spaces as interactive and to plan them with increased heights and with flexible spatial organizations, to serve different purposes [5]. In order to increase security, it is best to locate them on the ground floor or first floor of residential buildings, but in such a way that they do not disturb the surrounding residential space. These areas may be planned as indoor or outdoor.



Figure 5. Shared indoor interactional areas - 60 Richmond Housing Cooperative/ Teeple Architects (2010), Toronto, Canada⁵

The disadvantage due to the high occupancy rate at the 60 Richmond Housing in Toronto is reduced by the introduction of common facilities within the building (Figure 5). On the first floor, for the purpose of tenants gathering and leisure, a larger indoor common space is formed, equipped with a small kitchen and toilets. The quality and usage intensity of this space is enhanced by the addition of a large, green terrace, oriented towards the street and the inner atrium. In addition to the first floor common area, on the sixth-floor is introduced the common open terrace, primarily intended for urban agriculture for the needs of the tenants themselves.

In the case of Via Verde in New York, the lack of high occupancy rate has been overcome by the development of common areas upon the building rooftop. In order to maximize the outdoor living, the flat rooftops are planned and designed as a walkable space, with an idea to create an alternative common area – a kind of “rooftop promenade” (Figure 6). In order to make this space easily visible and accessible, not only to the tenants but also to the neighbors from the immediate environment, the building volume is divided into cascades. The introduction of a wide staircase to the roof terrace of the first cascade allows its direct connection with the terrain, while further the system of stairs and ramps leads visitors to the roof terraces on the higher cascades. Each roof terrace is unique in character, designed as a space for rest, sitting, recreation, gardening, agriculture and etc. The

⁵ Source: <https://www.archdaily.com/85762/60-richmond-housing-cooperative-teeple-architects>

“promenade” is connected with a common indoor multifunctional space located on the third floor and with a recreation space on the last floor.



Figure 6. Shared outdoor interactional areas - Via Verde / Dattner+Grimshaw (2012), New York, USA⁶

4. CONCLUSION

Housing conditions meeting the complex needs of different individuals have a beneficial effect on their proper psychosocial development and positive social action. Implementation of the specific spatial design is especially important in the field of social housing, since in such wider context it can be used as a corrective to certain negative social phenomena, which are expected within these types of facilities and so it can support their sustainability.

The criteria defined in this paper for the spatial development of internal space in social housing is a set of desirable measures aimed at improving the housing standards. Five criteria defined in the paper: 1) building assembly, 2) organization of the internal communication space, 3) distribution of different apartment unit types, 4) flexibility of the space and 5) shared interactional areas forms a certain model that can be used for the development of social housing. This model is primarily an important tool for architects engaged in the design of social housing and for those involved in architectural and urban development of specific locations allocated for this purpose. Although in economic terms the introduction of such criteria implies somewhat greater initial investment, its application provides significant social benefits. First, the need for relocation is reduced - which improves the efficiency of the operation of social housing. Secondly, the negative social aspects of social housing are reduced – which makes these new developments in social housing act as certain correctives of the overall social development. Consequently, the application of this model has a positive effect on the sustainability of social housing.

LITERATURE

- [1] Čolić Damjanović V. M. (2015), Unapređenje modela socijalnog stanovanja u Beogradu u okviru novih paradigmi planiranja i projektovanja, doktorska disertacija, Arhitektonski fakultet, Univerzitet u Beogradu
- [2] Marušić, D., (1999) Sveska 1-10, Arhitektonski fakultet Beograd
- [3] Newman O. (1996), Creating Defensible Space, Institute for Community Design Analysis, U.S. Department of Housing and Urban Development, Office of Policy Development and Research
- [4] UN, (2006), Uputstva o socijalnom stanovanju-Principi i primeri, Ujedinjene Nacije, Ekonomska komisija za Evropu, Ženeva
- [5] Levitt D, Levitt B. (2010), The housing design handbook, Routledge, Taylor & Francis Group
- [6] Milić V. (2006), Urbanistički aspekti socijalnog stanovanja, Arhitektonski fakultet, Univerzitet u Beogradu
- [7] Ilić D. (1983), Stan i porodica, Gradina

⁶ Source: <https://www.archdaily.com/468660/via-verde-dattner-architects-grimshaw-architects>

- [8] Stoiljković B. (2015), *Primena koncepta individualizacije u stambenoj arhitekturi u kontekstu unapređenja višeporodičnog stanovanja*, doktorska disertacija, Građevinsko-arhitektonski fakultet, Univerzitet u Nišu
- [9] Bramley G, Power S. (2009), *Urban form and social sustainability: the role of density and housing type*, *Environment and Planning B: Planning and Design*, 36, pp.30–48.
- [10] Dinić Branković M. ,MitkovićP., (2019), *Urbana funkcija stanovanje*, Univerzitet u Nišu – Građevinsko-arhitektonski fakultet
- [11] Gehl J. (1987), *Life between buildings: using public space*, New York: Van Nostrand Reinhold Comapny
- [12] Bridge G. (2002), *The neighbourhood and social networks*, CNR Paper 4. ESRC Centre for Neighbourhood Research, Bristol
- [13] Henning C, Lieberg M. (1996), *Strong ties or weak ties? Neighbourhood networks in a new perspective*, *Scandinavian Housing & Planning Research*, 13, pp.3–26.
- [14] Cattell N, Dines N, Gesler W, Curtis S. (2008), *Mingling, observing, and lingering: Everyday public spaces and their implications for well-being and social relations*, *Health Place*, 14, pp.544–561
- [15] Reeves P. (2005), *Introduction to social housing*, Elsevir
- [16] Rabeneck A, Sheppard D, Town P. (1974), *Housing: Flexibility/Adaptability?* *Architectural Design*, 44, pp.76–90.
- [17] Groák S. (1992), *The Idea Of Building: Thought And Action In The Design And Production Of Buildings*, London: E&FN
- [18] Jovanović G, Keković A. (2008), *Fleksibilna organizacija sklopa sprata i prostora stana kod zgrada dubokog trakta*, *Zbornik radova Drugog internacionalnog naučnog skupa "Građevinarstvo-nauka i praksa" Žabljak 03-07. mart 2008.godine*, Univerzitet Crne Gore – Građevinski fakultet, Knjiga 1, pp.579–585.
- [19] Živković M, Jovanović G. (2012), *A method of evaluating the degree of housing unit flexibility in multi-family housing*, *Facta Univeritatis. Series: Architecture and Civil Engineering*, 10(1), pp.17–32.



Milena Dinić Branković, University of Niš, milena.dinic@gaf.ni.ac.rs

Jelena Đekić, University of Niš, jelena.djuric@gaf.ni.ac.rs

Milica Igić, University of Niš, milica.igic@gaf.ni.ac.rs

Milica Marković, University of Niš, milica.markovic@gaf.ni.ac.rs

SMALL URBAN STREAMS IN ENHANCING CITY RESILIENCE – THEORETICAL PERSPECTIVE AND THE POSSIBILITIES OF USE IN THE CITY OF NIŠ, SERBIA

Abstract

Within an integrated planning approach, urban streams are a valuable natural resource with strategic significance for creating resilient cities. This paper explores the revitalization of small urban streams within sustainable development practices, and discusses the manifold benefits that it brings about. Best practice examples are presented to illustrate how watercourse revitalization improves flood mitigation and stormwater treatment, strengthens urban ecology, diversifies recreation options, and enhances visual appeal of the waterfront. These experiences are used to establish urban planning and design guidelines for revitalization of small streams in the City of Niš. The results of this study should help with both setting up policy framework and implementation in planning practice.

Keywords: stream revitalization, urban planning and design, flood protection, ecology, recreation

МАЛИ УРБАНИ ВОДОТОЦИ У ПОВЕЋАЊУ ОТПОРНОСТИ ГРАДА – ТЕОРЕТСКИ ОКВИР И МОГУЋНОСТИ КОРИШЋЕЊА У ГРАДУ НИШУ, СРБИЈА

Сажетак

У оквиру интегрисаног приступа планирању, урбани водотоци су вредан природни ресурс са стратешким значајем за креирање отпорних градова. Овај рад истражује ревитализацију малих урбаних водотока у оквиру пракси одрживог развоја, и разматра многоструке користи које она доноси. Представљени примери добре праксе илуструју како ревитализација водотока ублажава поплаве, унапређује третман атмосферских вода, јача урбану екологију, диверзификује могућности рекреације и појачава визуелну привлачност приобаља. Ова искуства се користе за утврђивање планерских и пројектантских смерница за ревитализацију малих водотока у граду Нишу. Резултати ове студије би требало да помогну у постављању законодавног оквира и имплементацији у пракси планирања.

Кључне ријечи: ревитализација, планирање и дизајн, заштита, поплава, екологија, рекреација

1. INTRODUCTION

Urban planning is based on the way in which human interactions shape physical space. The concept of Integrated Planning comprises a system of interlinked actions that bring about a lasting improvement in the physical, social, and cultural conditions of a city or an area, covering a wide range of interrelated aspects - from governance, economy and planning, to physical infrastructure, sustainable buildings, climate adaptation and environment [1]. Planning for disaster risk reduction is an integral part of urban planning nowadays, since basic hazard and risk mapping represent a preliminary planning instrument that guides further development.

In adapting to climate change and increasing the overall resilience of urban areas to natural disasters, flood protection is one of the crucial topics. Flood protection is mostly, but not solely, an engineering issue. The role of urban planning in protecting urban areas from flooding is gaining increasing importance nowadays. As stated by Ramboll [2], the main constraints on implementing sustainable urban stormwater management and environmental management in a changing climate are not technological, but they rather involve shifts in vision, policy, design, and the urban planning culture. In urban planning documents, small streams in urban areas often do not get enough professional attention. Additionally, they seem to be out of sight even with the local community, which is unaware of their great potential. Aside from flood protection and generally improved urban hydrology, restoration of polluted, neglected and devastated urban streams may come with a range of ecological, social and economic benefits [3]. Some of them include: improved water quality, enhanced biodiversity, diversified recreation options, mitigation of urban heat, improved public health, appealing urban landscape, and reduced costs associated with repair of erosion and flood damages.

Many cities around the world are exploring options to capitalize on the potential of small urban streams in addressing the climate change challenges and improving the resilience of urban areas. This paper discusses the main urban planning and design principles and approaches in the revitalization of small urban watercourses worldwide, and examines their potential use in shaping the post-socialist urban landscape in the City of Niš, Serbia. With a population of approximately 260.000 inhabitants (2011 Census), Niš is the third largest city in Serbia and a typical post-socialist city of medium-size. The City of Niš has a very rich water potential in small streams and creeks that is quite underused in environmental, social and economic terms [4]. Contemporary integrated planning approaches have not yet been comprehensively reviewed and implemented in urban planning policy and practice.

It is the standpoint of this research that the revitalization of small urban streams would bring manifold benefits to the City of Niš, and increase the resilience of its urban area. Therefore, the main goals of this paper are: (1) to determine the benefits that the process of revitalization of small urban streams brings about to urban areas; and (2) to establish urban planning and design guidelines for revitalization of watercourses that should help in retrofitting small urban streams in the City of Niš.

2. MATERIALS AND METHODS

This paper explores revitalization of small urban streams by using empirical research and review of relevant literature. The methodological framework is conceptualized on description and analysis of best practice examples of stream revitalization, with the synthesis of study findings subsequently used as a baseline for formulating urban planning and design guidelines for the City of Niš scenario. Particular cases of good practice were chosen to best reflect the benefits of stream revitalization, and involve comprehensive completed projects whose effects can be evaluated. The City of Niš makes a suitable research polygon due to its significant “blue” natural capital in small waterways.

Aside from two major watercourses (Nišava and Južna Morava), there are also twenty-one small urban streams in the territory of the City of Niš, which is the area covered by the Master Plan (MP) of Niš 2010-2025 [4]. Two of them are waters of the first order (Toponička and Kutinska River) and the rest are waters of the second order⁷. The localities that are endangered by flood waters from small urban streams are established in the MP of Niš 2010-2025 [5] (Figure 1). This paper explores the potential for increasing the resilience of these flood hazard zones. Therefore, research focus is set on nine small urban streams that pose a flood disasters risk to communities in Niš urban area: Kutinska River, Gabrovačka River, Suvodolski Creek, Kovanlučki Creek, Suvobanjski Creek, Matejevačka River, Brenička River, Rujnička River and Humski Creek. The effect of these

⁷ According to the Water Law of the Republic of Serbia (2018), in line with their importance for water management, surface waters in Serbian territory are divided into waters of the first and second order.

watercourses on rural settlements, beyond urban border, is not evaluated in this study. Characteristics of small urban streams and related flooding issues are determined on the basis of field investigations, the use of various legislation, satellite photo images and available data from internet sources. Review of standing planning documents provided the information on planned land uses in watercourses adjacent areas, which are relevant for the proposed guidelines.

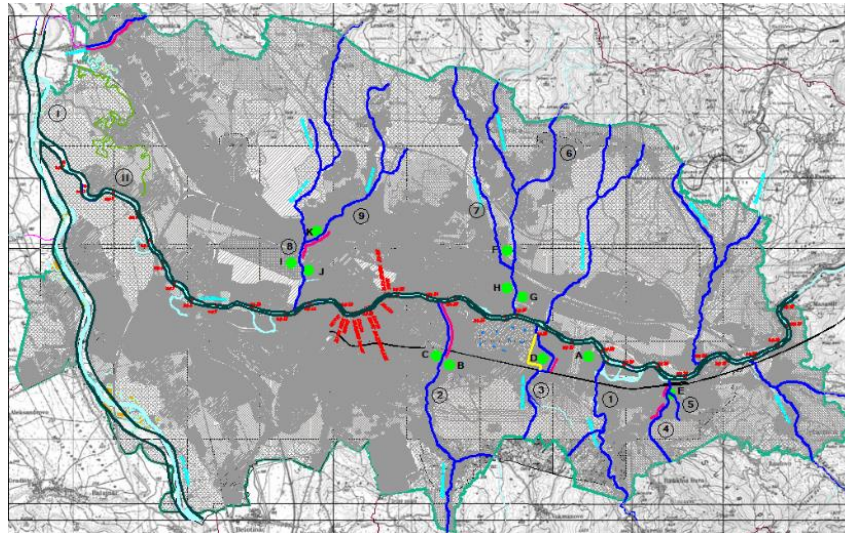

- Border of MP of Niš 2010-2025 area
- Localities endangered by flood waters (A-K)
- Large watercourses
- Small urban streams (selected 1-9)
- Regulated stream
- Newly planned stream route

I Južna Morava, II Nišava, 1. Kutinska River (8 km), 2. Gabrovačka River (5,5 km), 3. Suvodolski Creek (4,5 km), 4. Kovanlučki Creek (3 km), 5. Suvobanjski Creek (1 km), 6. Matejevačka River (7 km), 7. Brenička River (7 km), 8. Rujnička River (9 km), 9. Humski Creek (8,2 km).

Figure 1. Watercourses in the City of Niš with selected small streams and length in MP area.
Source: Authors' drawings on the MP of Niš 2010-2025: Infrastructure - Plan of regulation of watercourses

3. URBAN PLANNING AND DESIGN GUIDELINES FOR INTEGRATING SMALL URBAN STREAMS

Guidelines for the urban planning framework that are elaborated in this chapter are summarized around the following crucial points [6]: (1) *Flood protection*, (2) *Urban ecology*, (3) *Recreational areas*, (4) *Appealing urban landscape*, (5) *Sustainable mobility*, (6) *Community engagement*, and (7) *Risk management*. Tools and strategies of urban design that are used in stream revitalization, are discussed within each of the established topics.

3.1. FLOOD PROTECTION

Enabling effective flood protection in urban areas first of all implies implementing linear and retention measures along the stream. Both of these measures can be viewed as active flood protection or structural measures, which are mainly proposed and developed by hydrological engineers. This chapter discusses flood protection from an urban planning perspective. The City of Graz is, for example, implementing comprehensive flood protection measures through the Streams of Graz program (2006), a program for the restoration of small watercourses, where both linear and retention measures are coordinated with spatial planning.

Linear measures against floods are established in order to control the water regime, while retention measures imply the construction of retention structures. Linear protective measures include widening of the streambed, raising the embankment or the adjacent terrain, removing discharge obstacles and pruning streamside vegetation to remove the narrow passes [7]. Sometimes, linear measures alone are sufficient to safely conduct the water flow to the recipient, without endangering the surrounding areas. In other cases, it is necessary to provide an upstream flood retention basin, in order to safely drain flood waters down the stream. Retention areas and flood plains are zones along the watercourses into which floods may spread without presenting a hazard [7]. Retention basins decrease the discharge to a certain extent, thus enabling the downstream sections to better cope with

flood waters, preventing the stream outflow from its riverbed and mitigating flood risk. Zones of undeveloped land are very difficult to find in densely built urban areas, so retention basins are often constructed outside of urban areas, where more open space is available. Developing wetlands and parks in retention basins is suggested as the appropriate choice for the landscaping of these areas. Wetlands planted with native plants increase the detention capacity of flood waters and help with water cleansing, while parks enable controlled flooding and provide a useful amenity for the community. Given the scarcity of open space along the watercourses, it is imperative that these zones are retained without any development, and dedicated for retention purpose.

Deculverting enclosed/piped streams is a critical measure against flooding. Throughout urban history, small urban watercourses were often hidden in culverts and pipes and buried underground, to make way for new developments and expansion of urbanized areas [6]. Nowadays, cities around the world are increasingly attempting to restore buried streams. The process of reopening streams is often referred to as “decuverting” or “daylighting”. Daylighting consists of exposing some or all of the flow of a previously buried stream by creating a new streambed, and may include the creation of ponds, wetlands or estuaries [8], thereby re-establishing the natural stream structure. Particularly extensive activities on reopening buried rivers and streams are undertaken by the City of Oslo within the project Oslo Reopening Waterways [9], as an integral part of climate change adaptation plan to make the city resilient to flood risk.

Implementing contemporary integrated stormwater management approaches, complemented with the elements of blue and green infrastructure, is the final instrument of urban planning and design that is considered to be of great significance in preventing flooding. Namely, increasing urbanization has resulted in the increase of paved surfaces in urban areas, which are usually impervious, and thereby alter both the quantity and quality of surface runoff water [10]. In terms of quantity, less water is infiltrated and more runs off at the surface, which affects the physical structure of streams and rivers, and may cause flash flooding. Regarding the quality, most of the water runoff nowadays contains pollutants caused by human activities (hard metals from roads, roofs and paved surfaces, lawn chemicals from fertilization). When these hard materials enter the rivers and streams, they cause water pollution and endanger the biodiversity. Therefore, new strategies and approaches⁸ have been developed in the last couple of decades to mitigate the impact of stormwater runoff and pollutant loading. All of these contemporary approaches are based on similar concepts - they integrate the hydrological cycle into urban design, use natural processes that result in the retaining, filtering and absorbing stormwater, along with evapotranspiration or re-use of stormwater, in order to reduce flood risks, protect water quality and biodiversity, and improve urban recreation options [11, 12, 13, 14].

In stormwater management, the role of “Blue-Green Infrastructure” (BGI) is becoming increasingly important as an alternative to conventional pipe-based stormwater management in cities [15]. BGI connects [4]: (1) the blue component, which refers to urban hydrological functions, such as watercourses (rivers, streams) and still waters (lakes, ponds), and (2) the green component, which entails vegetated areas in urban environment, such as urban forests and meadows, parks and protective greenery. Typical BGI elements for stormwater management found in waterfront areas involve bioswales, cleansing biotopes/rain gardens, retention and detention swales and lakes, infiltration trenches, etc. Aside from them, permeable pavement and drywells are also technical elements for stormwater management that may be used in waterfront areas. By reintroducing natural processes within the built environment, BGI also strengthens urban ecosystems and improves quality of life [2].

3.1.1. Best practice illustration - Hølaløkka Waterpark, Oslo, Norway

Hølaløkka Waterpark is a waterway rehabilitation projects undertaken in Oslo, when a 300 m-section of formerly culverted Alna River was reopened. The aim of the project was to combine a technical water management system, where ecological and hydrological needs are met, with a design that maximizes the potential of an appealing outdoor space [16]. Water management concept implies directing rainwater into an open canal, returning water to the surface, cleansing it from pollutants and releasing back into the Alna [16]. First, the river enters a restored and widened riverbed in the corner of the park, and is next released into a natural settling basin (Figure 2). Then, the river moves through small waterfalls and flows into an open swimming pond in the middle of the park, which holds back flood waters. The adjacent meadow serves the double purpose of an informal relaxing

⁸ Most prominent stormwater management approaches involve Best Management Practices (BMP) and Low Impact Development (LID) in the United States of America, Water Sensitive Urban Design (WSUD) in Australia and Sustainable Drainage System (SuDS) in the United Kingdom.

area and a flood meadow [16]. Finally, the river goes through the a wetland area, which is developed in for stormwater treatment.

Stormwater management of the adjacent industrial buildings and traffic areas is combined into the river system [17]. The run-off from the roof, surface and roads is first conveyed via surface drainage to a cleansing biotope area. Here, the pollutant break-down from the stormwater run-off occurs, and rainwater is cleansed through a multi-layered substrate. Then, the water is released to a subsequent newly created wetland with detention capacity, which treats polluted stormwater and holds it back for slow release. After the project was completed, a significant reduction of pollutants was confirmed, a trend which is expected to increase and stabilize in the long run [16].

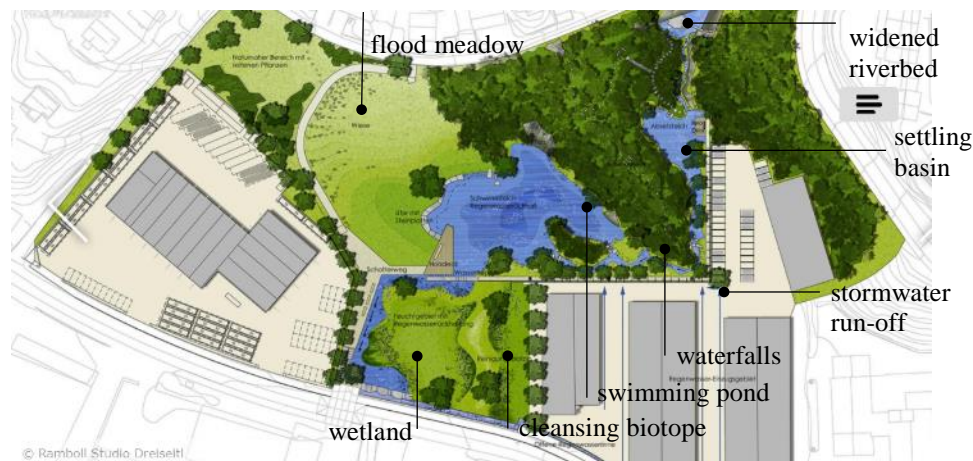

Figure 2. Hølaløkka Waterpark landscape plan and amenities

3.2. URBAN ECOLOGY

Strengthening urban ecology represents a vital aspect in revitalizing small urban streams, which often involves implementing elements of BGI. Renaturation of the watercourses implies creating new habitats in revitalized watercourses and adjacent urban green spaces. The main goal is to make both the streams (blue component) and the green areas surrounding the watercourse (green component) as natural as possible, in order to enhance biodiversity of the area and create new habitats for fish, insects and birds. In the process of stream renaturation, it is therefore advised to plant native, site-specific vegetation and introduce local aquatic species.

Another important planning measure that improves urban ecology concerns developing natural self-cleaning systems, where natural soils and plant life improve water quality by filtering pollution. Such systems are based on nature's own self-purification of water through planted wetlands, pools and various BGI elements. Positioning these elements in upper reaches of the stream enables cleaner water for the downstream sections.

3.2.1. Best practice illustration - Teglværksdammen project, Oslo, Norway

In the project of reopening a 650 m-section of Hovinbekken stream in Oslo, a large-scale biological cleaning system and a spectacular recreational space called Teglværksdammen was created [6]. This natural cleaning system that filters incoming waters consists of several sedimentation basins, a small lake (large pond), three dams, streams with rapids, and high-density native vegetation in shallow waters that act as wetlands [9] (Figure 3). Untreated water from the culverted stream flows into the first section of the restored reach, Tennisdammen. It consists of two pre-treatment settling pools and permeable thresholds with emerging macrophytes, and retains most of the sludge, suspended particles, as well as the associated nutrients and pollutants [18]. From here, the water runs into a section with riffles, pools, dense emerging macrophyte vegetation and permeable thresholds. Next, the water flows into the first wetland, which transitions into the largest pond called Teglværksdammen, and again transitions to the second wetland. Finally, the water enters the last sedimentation pond in the reach, Grensedammen. Within this system, the sediments settle and the water is filtered through rocks and vegetation. The east side of the pond is hilly and vegetated as a riparian zone, while asphalt and concrete surfaces are located at the west side. After reopening the stream, the City of Oslo monitors water quality at Teglværksdammen, and the results indicate the potential for purification [19].

The revitalization of Hovinbekken at Teglværksdammen has enabled the development of a clean habitat to native species and rejuvenation of local biodiversity. In all projects of reopening watercourses, including this one, the City of Oslo attempts to maintain the aquatic habitat and

surrounding environment in their natural state. Restoring aquatic and terrestrial ecology with native species involves [9]: (1) planting only native vegetation in water networks and adjacent land, which includes marsh marigold, purple loosestrife, yellow iris, bulrush, reed canary grass and common alder; and (2) creating natural bottom substrates for invertebrates and fish. The restoration projects are also recovering migration paths for fish, which has enabled breeding and population growth of migratory fish in the region.

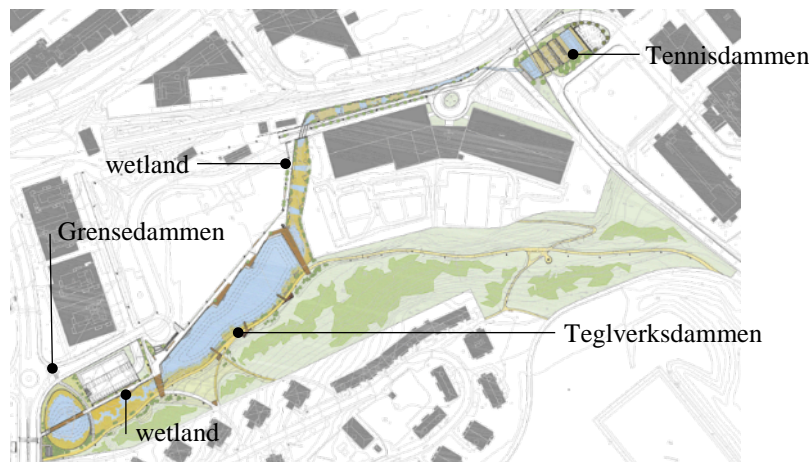

Figure 3. *Teglverksdammen landscape plan.*

3.3. RECREATIONAL AREAS

When creating recreational areas along the streams and their adjacent surfaces, these areas should be developed as nature-like zones for both active and passive recreation for all user categories. A renatured stream that creates park-like environment with rich vegetation and various amenities, enables widely-practiced recreation in the river landscape. Suggested amenities include playgrounds for children, sport fields and hiking trails for younger adults, and various types of open spaces for strolling, gathering and rest for adults and the elderly (walking and bicycle paths, fitness areas, sitting areas, plazas, squares, waterfront decks, etc.). An additional benefit that the implementation of various amenities for outdoor activities brings to recreational areas, is creating opportunities for social interaction. Large number of people is attracted to such diverse settings, and social contacts are more easily established.

In shaping the recreation area in the waterfront zone, suggested design implies enabling easy user access to the stream itself. This is achieved by designing stairs that lead all the way down to the water, and thus enable a close encounter with nature, which is a particular attraction for children. An important design guideline concerns the provision of adequate lighting to enable recreation in the evening. A well-designed lighting plan for the recreation area will improve public safety.

3.3.1. Best practice illustration - Bjerkedalen Park, Oslo, Norway

Bjerkedalen park is situated along Hovinbekken stream in Bjerke neighbourhood in Oslo. It is located in the middle of a residential urban area that used to have few public spaces. Restoration project involved reopening 300 m of the formerly culverted stream, with the main aim of improving water quality, preventing floods and creating new green areas [20]. At the same time, all these actions improved the overall urban landscape and created an attractive recreational area, with various amenities for outdoor activities (Figure 4). A terraced park pavilion, which is conceptualized as the focal point of the area, contains an amphitheater with a view, a café and a large outdoor terrace [21]. In the central area of the park there is also a basketball court, while the sand volleyball court is located in the corner of the park. The central promenade and new smaller trails meander through the park alongside the stream, with maximum 5% slopes. The stream canal in the central park area is shaped with green stepped edges. In the southern part of the park, a 3 m deep bathing pond is created, along with a sandy beach. In wintertime, the pond is used as an ice-skating rink. Children's playground is positioned near the kindergarten. Green areas include 2,5 hectares of lawn and 5 hectares of flowering meadow, with planted 50.000 perennials [21].

This park also plays an important role in stormwater management, since it functions as a retention basin during extreme weather events. Rapids, ponds and small waterfalls increase the appeal of the area and create a habitat for aquatic species. Bjerkedalen Park has become the focal point of the Bjerke District and a natural meeting place. The project also brought about social and health benefits

to the residents, such as the improved access to urban green space, increased opportunities for social interaction and gained amenities for recreation and exercise [20].

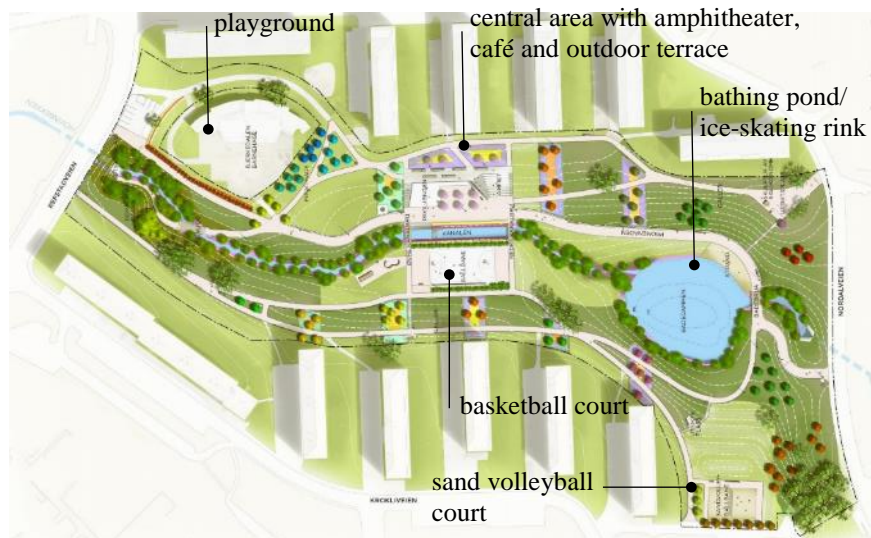

Figure 4. Bjerkedalen Park landscape plan and amenities.

From the aspect of urban design, improvement of the overall aesthetics of space in revitalizing urban streams enhances the experience of users. Visual appeal of a waterway landscape can definitely be enhanced by creating a park environment. This implies introducing both greenery (green component) and additional hydrological features beside the stream (blue component). Green surfaces should dominate in spaces adjacent to waterways, in comparison to paved areas. Natural soils and natural surface cover absorb less sun radiation and emit less urban heat, and are therefore advised in waterfront areas in order to create favorable microclimate. Aside from the quantity of greenery in a renatured stream area, their quality and diversity also represent important design issues. It is suggested to implement diverse types of greenery within meadows, open grassy areas, flower beds and parks. In some stream revitalization projects, implementing additional water elements in areas adjacent to the stream is advised, as a tool of urban design that enhances the overall quality of the project. In shaping the appealing urban landscape, a variety of water features such as lakes, ponds, dams, canals, rapids and waterfalls, can bring added value to the aesthetics of the waterfront.

3.3.2. Best practice illustration - Arkadien, Winnenden, Germany

Arkadien Winnenden is a regeneration project developed on the site of a former factory, along Zipfelbach stream in Winnenden. Zipfelbach stream has also been ecologically restored. Together, these interventions resulted in the Arkadien being one of the most sustainable and cohesive neighborhoods in the world. Urban design is based on mixed architectural typologies, appealing Mediterranean color concept, “shared streets” and water sensitive urban design [22] (Figure 5). High quality of the streetscapes is achieved with dominantly pedestrian character, even though vehicular traffic is possible. The concept of shared circulation implies that the site is accessible for vehicles, but with reduced speeds. Parking options are provided in an underground garage, limited street parking, carports, and individual parking spots positioned between gardens on the unique load-bearing planting substrate. Pavement includes recycled granite, and permeable concrete pavers and asphalt. The appeal of the streetscapes is enhanced with generous planting. Street corners are envisioned as mini-plazas for social interaction and children’s play.

The stunning lake is the focal point of this development. It manages flood waters from both the site itself and the adjacent stream Zipfelbach. The lake also acts as a rainwater detention basin. It captures and filters rainwater in a stepped system, cleanses it through natural plant processes, before overflowing to a flood meadow and slow releasing to the stream. A major part of the precipitation at the site is captured, and re-used in toilets, fountains, and irrigation. The use of permeable pavers and the innovative use of structural bearing soil substrate for garden-like parking spaces, has reduced the impermeable surfaces to only 30% of the site [23]. All of the stormwater management elements - retention lake, flood meadows and permeable surfaces, jointly contribute to the reduction of flooding in the local urban catchment. The planting concept uses locally native species, which support birds and bees. The stream’s park integrates play areas, cycle routes and flood meadows. The creation of this vibrant ecological neighborhood has managed to foster social stability and

community feeling. Affordable housing prices are making the ecological and sustainable home an available option for everyone's budget.

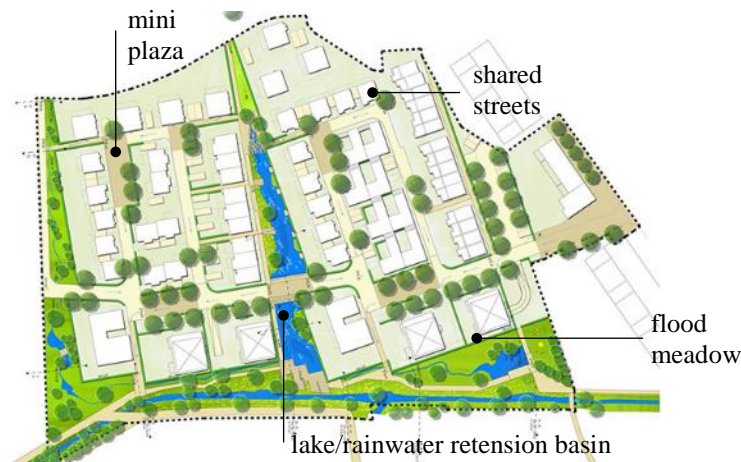

Figure 5. Arkadien landscape plan and amenities

3.4. SUSTAINABLE MOBILITY

Implementing sustainable mobility solutions is an imperative in planning resilient urban areas. These transportation options are fostered in contemporary development because of their benefits for the environment and public health. Small urban streams, and watercourses in general, play an important role when tracing routes for sustainable mobility. From the standpoint of urban planning and design, it is advised to develop bicycle and pedestrian pathways made of permeable material along the streams. Sustainable mobility routes are best fitted within the city BGI grid, which is created by interconnecting various natural open spaces in urban areas with green or blue linear pathways. In shaping the city transport infrastructure, it is also vital to inter-link bicycle and pedestrian pathways with the city transportation network, in order to enable a variety of transportation options.

3.4.1. Best practice illustration – Alna Trail, Oslo, Norway

The City of Oslo has developed a comprehensive plan for a network of walking and cycling paths, and a number of routes have already been completed. The longest of these inter-connected paths runs along the course of Alna River, and is called the Alna Trail. Alna Trail was developed within the Grorud Valley Project, whose main aim is oriented towards sustainable urban development, environmental upgrades and improvement of the quality of life [24]. Additionally, efforts to strengthen the Alna were anchored in the Municipal Sector Plan for the Alna Environmental Park. This plan facilitates reopening and environmental improvement of Alna and its tributaries, from Alna Lake to the fjord, along with the creation of blue-green infrastructure.

The 10 km long Alna Trail starts at the forest edge at Ammerud, and runs along Alna River until Svartdalen area (Figure 6). Alna Trail now represents the longest stretch of inter-linked walking trails and green spaces along the course of Alna River. The path first goes through Grorud Park, which was inserted into the existing green corridor along reopened river. It is of vital importance for the trail that the main barriers for pedestrians and cyclists in the Grorud Valley were removed, thus enabling continuous flow. One of the major obstacles on the route was the railway line. With the construction of the 40 m long underpass called Haugen Gate, strolling along the Alna Trail was enabled without detouring. Also, in routing and shaping the Alna Trail, the signposting was improved. Next, Alna Trail passes through the Hølaløkka Water Park and its attraction Leir Waterfall. This waterfall, which used to be hidden behind a concrete dam, was also reopened, and the access to it is significantly improved. The next park along this trail is Alnaparken. Further west, the trail continues as a universally designed gravel road through a lush natural area called Fagerlia. The entire section is well signposted, giving people the opportunity to choose several alternative paths. Finally, one of the most interesting segments of Alna Trail is a section through the Svartdalen nature area. A unique feature of this project is a 250 m long wooden boardwalk, which meanders above the river near the Ekeberg escarpment [24]. By the Nygård waterfall, one of the biggest waterfalls in the Alna, the trail crosses a new suspension bridge.

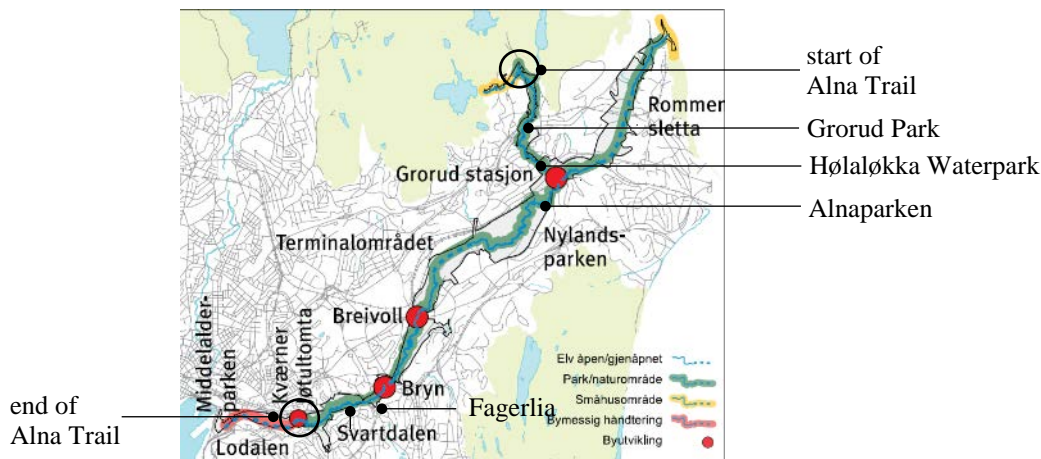

Figure 6. The route of Alna Trail, in Alna Environmental Park

3.5. COMMUNITY ENGAGEMENT

Revitalizing small urban streams can be an important tool for cities looking to profile their image as a resilient community with sustainable design solutions. Aside from institutional and political support in implementing “blue-green” projects, significant efforts are required in obtaining broad civic support and involving the community. Particularly, small urban streams often seem to be neglected, devastated and forgotten, until a flood event occurs [4]. Therefore, in the urban planning process, community engagement is of crucial importance.

Participatory bottom-up approach is advised when gathering input data for the planning documents, along with integrating user’s opinions in the vision for the waterfront area. When conceptualizing planning and design solutions, it is advised to promote healthy lifestyles, such as walking, cycling, exercising and establishing a contact with nature, along the revitalized streams. Designating streams as potential research polygon for local schools and health laboratories is another important measure. When presenting the plan to the public and elaborating on the proposed planning solutions, raising awareness on the significance of the streams is necessary, along with creating a positive image with the local population. After the plan is adopted, it is crucial to continue educating local population on different projects, so that their support is gained for realization of both proposed solutions and future interventions. These are all important actions that enable the local people to see waterfront areas as their own recreational space, the space that is theirs to love, maintain and improve.

3.5.1. Best practice illustration – Bishan-Ang Mo Kio Park, Singapore

Singapore is an example of a city where adoption of BGI is now extremely popular with citizens even though the support for BGI was originally institutional and top-down-driven. The successful BGI implementation in Singapore is partly due to a large public awareness campaign to overcome objections, while the other reason can be found in the huge success of Bishan-Ang Mo Kio Park as a pilot BGI project [2].

Bishan-Ang Mo Kio Park is a large regional park situated between two residential areas in Singapore. In the early 1980s, a concrete canal for the Kallang River in the middle of the park was built for flood mitigation, collecting water from the surrounding neighborhoods. In 2006, Singapore’s national water agency Public Utility Board initiated the Active, Beautiful and Clean Waters Program, as a long-term initiative to transform the country’s water bodies beyond their functions of drainage and water supply, into vibrant, new spaces for community bonding and recreation [25]. When Bishan Park was chosen to be a demonstration project for integrated water management that uses elements of green design, both the park and the canal were in need of restoration. Landscape design concept removed the 2,7 km concrete canal and introduced a small, meandering 3,2 km natural stream (Figure 7). During periods of intense rainfall, the green space adjacent to the stream receives excessive water and doubles up as a conveyance channel. Within the 62 hectares of redesigned park space various amenities are provided: three playgrounds (adventure playground with climbing facilities, water playground fed with naturally cleansed river water, and sand-filled bubble playground), two restaurants, Recycle Hill (new landmark, constructed by using the recycled walls of the old concrete channel), several ponds, a cleansing biotope, plazas, and plenty of open green spaces that serve as playing fields, fitness areas and event spaces. The stream provides natural cleansing of runoff through bioretention and filtration. Natural plants and soil in the

cleansing biotope purify the water from the stream and ponds. Today the park serves as a recreational space for the local residents and an opportunity to reconnect with nature.

Before revitalization, the responsibility for the park laid with the National Parks Board, and for the drainage channel with the Public Utility Board. With the implementation of integrated water management and BGI, the two agencies collaborated, which inspired similar inter-agency partnerships for other projects. The revitalization team was fully dedicated to the project, from the urban planning stage to the construction itself, convincing stakeholders, engaging experts and organizing art and education workshops with children [25]. Despite the fact that Bishan-Ang Mo Kio Park was not a community-driven effort, various stakeholders were working together on fulfilling multiple objectives. Even before the park was completed, the phenomenon of “self-policing” had been observed with locals, who were looking out for the cleanliness of the park and the safety of others [25]. The changed attitude and ownership towards the river park are nowadays best reflected in the activities such as regular meetings of self-organized interest groups, or field trips to the park organized by local schools. The holistic approach to this project recognizes that the park and the drainage channel are integrated and interdependent elements of ecological and social infrastructure [25]. The project Bishan-Ang Mo Kio Park is an inspiring example of an increasing civic responsibility towards water.



Figure 7. Bishan-Ang Mo Kio Park landscape plan and amenities.

3.6. RISK MANAGEMENT

Flood damage often cannot be prevented or reduced with structural measures alone (active flood protection). Therefore, passive/non-structural measures are also advised. From the standpoint of urban planning, they include performing risk analyses, developing forecast models and early warning plans, and integrating them into urban planning documents. Proper establishing of flood hazard zones in spatial and urban plans is particularly highlighted. Therefore, these areas should not be designated for development, or should be zoned as low-density areas where special building codes regarding flood protection apply (wet and dry flood proofing techniques). In this way, extensive damages can be avoided and safety of the population is enhanced. Another important point concerns informing the local population on housing options and personal protective measures in floodplain zones, via targeted campaigns. People inhabiting areas at risk of flooding, as well as users of public open space in riverfront areas, should be informed about the proper behavior before a flood event, along with conducting flood disaster drills. Promoting protective measures based on personal responsibility is also needed, because it educates local residents on what measures they should undertake to prevent or minimize the damage (i.e. insurance premiums).

3.6.1. Best practice illustration – Schöckelbach stream, Graz, Austria

The discharge measurements performed in 1997 on the streams of Graz, revealed that certain areas would be massively affected by floods having a return period of 30 and 100 years [7]. This includes both open spaces and areas that are already built-up, or designated as building ground. The hazard zone map drawn up by the Austrian Service for Torrent and Avalanche Control has also shown extensive settlements areas to be located in “red” and “yellow” hazard zones. In line with this information, a revision of the Master Plan was performed. All planned retention basins (primary and secondary options) are defined as priority areas for protective water management measures. Open areas within the existing high-water marks are identified, and they are designated as priority areas for the discharge of floods and as inundation zones [7]. In the land-use plan, retention basins and

retention zones are assigned the category “open space with special uses” and, in part, additionally designated as “reservation areas”.

For events of greater magnitude than a HQ100 event, the Streams of Graz program (2006) seeks to optimize alarm and contingency plans, in order to be prepared for flood disasters and to respond to them as early and as efficiently as possible. Alarm and disaster contingency plans establish the following [7]: (1) the timeframe at which the respective authorities have to be informed, (2) where relief teams are to be deployed, and (3) when the residents who are likely to be affected are alerted and evacuated, if necessary.

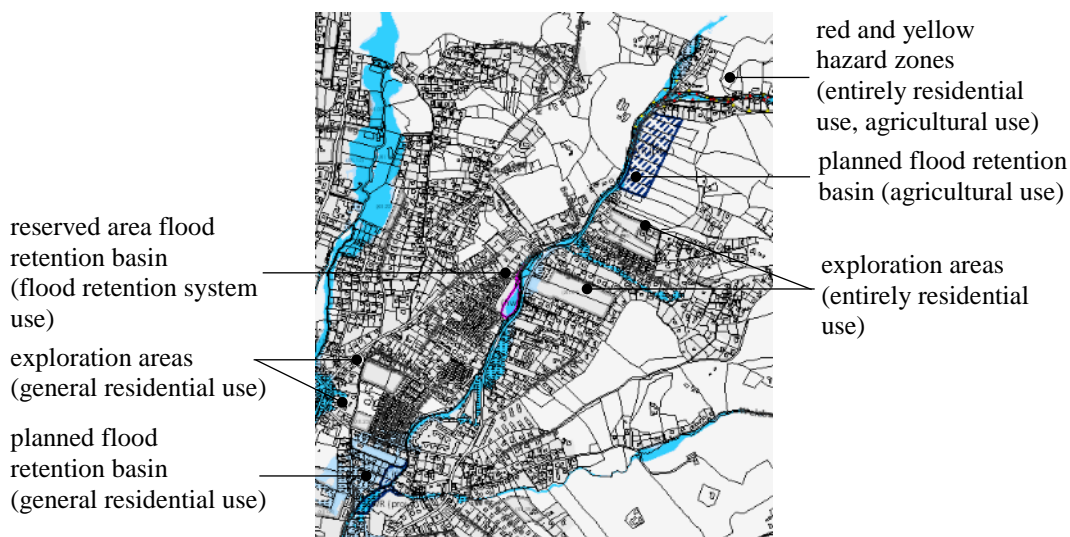

Figure 8. Segment of the Schöckelbach stream: plan of flood runoff and danger zones, with designated areas for flood discharge and their land uses (Source: https://geodaten.graz.at/WebOffice/synserver?project=STEK-FWP-RLB&client=core&view=4_0_FWPL_DP3)

4. INCREASING RESILIENCE TO FLOODING FROM SMALL URBAN STREAMS IN THE CITY OF NIŠ

4.1. SMALL URBAN STREAMS IN NIŠ – UNDERSTANDING THE CONTEXT

Erosion processes and torrential floods are among the most prominent natural hazards in Niš area. Small urban streams in Niš city territory significantly contribute to flooding due to their abundance and torrential character [4]. Aside from these natural factors, issues such as poor maintenance and waste disposal are characteristics of all small watercourses in Niš area, and often amplify water outflow to surrounding areas. Watercourses of the first order are under the jurisdiction of the Republic Public Water Management Company “Srbijavode”, while the City of Niš - Directorate for Agriculture and Rural Development is responsible for the watercourses of the second order. Public Water Management Company “Erozija”-Niš is in charge of the protection of land from erosion, torrents and the harmful effects of water. Green areas in Niš urban area are maintained by the Public Communal Company “Mediana”. It is often that the jurisdictions of these various companies regarding small streams are overlapping, and responsibility is transferred among them. This results in poorly maintained small watercourses, with plenty of debris and overgrown wild greenery that reduces the riverbed flow profile. The situation is additionally worsened with residents’ habits of disposing household waste into streams. Therefore, large amounts of debris and waste are carried with the flow, and often result in narrowing the flow profile of the streams. When it comes to community engagement in stream maintenance, the public has participated in several actions of cleaning small urban streams. These actions were organized by the Municipalities of the City of Niš and socially responsible companies, and jointly performed with the City’s Public Communal Companies. Some of them include the cleaning of Gabrovačka River in 2017, and the cleaning of Gabrovačka River, Rujnička River and Humski Creek in 2019.

An important ecological issue concerns sewage pollution from households, the weak legislation regarding large industrial polluters, and poor on-site control of implemented regulations. Water quality in Niš is monitored for the watercourses of the first order. Out of 9 selected streams in this study, the data on water quality is therefore available only for Kutinska River. According to the Report [26], Kutinska River has a mixed-excellent to poor ecological status from the physical-

chemical aspect, and poor ecological status from the microbiological aspect. Given the amount of waste disposal in the watercourses in Niš area, along with low ecological awareness of residents, similar poor ecological status regarding microbiology can be assumed for the remaining 8 small streams. From the physical-chemical aspect, poor ecological quality is expected in streams with adjacent production uses and large traffic areas.

Relevant data on the streams selected for this study, including main issues of concern regarding the flooding from a particular stream, is provided in Table 1.

Table 1. Selected small urban streams in the City of Niš (area of the MP of Niš 2010-2025)

Stream	Main flooding issues and flood events
No 1. Kutinjska River	- Floods 2004, 2012, 2014, 2018, 2021 - Unregulated riverbed with low throughput upstream of the railway - Torrential floods affect hydrological regime of Nišava River - Unplanned single-family housing infiltrates waterfront area - Unresolved land rights as an impediment for watercourse regulation - Numerous small tributaries, flooding outside of urban border
No 2. Gabrovačka River	- Floods 1926, 1948, 2021 - Unregulated riverbed with low throughput upstream from the railway - Flooding from the upper sections of the river, next to urban border
No 3. Suvodolski Creek	- Floods 2014, 2021 - Displaced natural course of the stream - Mostly unregulated riverbed, shallow throughout settlement Brzi Brod - Culvert at the boulevard road increases sediment deposition upstream - Dense urban fabric close to the stream, no space to retain floodwater
No 4. Kovanlučki Creek	- Partly regulated riverbed, existing regulation insufficient - Partly culverted throughout settlement of Niška Banja - Debris reduces flow profile of the regulated riverbed
No 5. Suvobanjski Creek	- Floods 2019 - Unregulated riverbed, low flow profile
No 6. Matejevačka River	- Surface erosion throughout most of the basin - Flow profiles partially closed at bridges by deposits, shrubs and trees - Unregulated, narrow flow profile throughout settlement Donja Vrežina - Unplanned residential development along the minor (lower) trough
No 7. Brenička River	- Displaced natural course of the stream - Insufficient throughput of the newly formed riverbed section that is conveyed into Matejevačka River - Unregulated riverbed partially enclosed by deposits, shrubs and trees at the culvert in Brenica and at the bridge in Kamenica, narrowed profile
No 8. Rujnička River	- Partly regulated riverbed, existing regulation insufficient - High level of groundwater in settlement Šljaka - Insufficient throughput capacity downstream of the boulevard road
No 9. Humski Creek	- Partly regulated riverbed - Unresolved land rights as an impediment for watercourse regulation - Insufficient throughput of unregulated sections through Donji and Gornji Komren, and of regulated section through Ratko Jović settlement
Sources of data: [4, 5, 27]	

4.2. URBAN PLANNING AND DESIGN GUIDELINES FOR RETROFITTING SMALL URBAN STREAMS IN NIŠ

Some planning measures for flood protection are provided in the MP of Niš 2010-2025 and in Plans of General Regulation (PGRs) of various city municipalities. Even though these planning documents support the creation of the BGI to some extent [4], the implementation of planning solutions is quite slow and does not involve contemporary watercourse management approaches. Therefore, this chapter explores potential additional urban planning measures, as well as tools and strategies of urban design, which should help in revitalizing small urban streams in the City of Niš, in line with

the main goal of flood protection. The guidelines also take into account other relevant topic for increasing the resilience of urban areas where small streams flow.

Constructing flood retention structures. Implementation of flood retention basins is not envisioned in the City of Niš territory. Planning documents should consider these retention measures along the streams that are prone to overflowing their riverbed in the entire course of the waterway. This is particularly advised for the streams that: (1) have considerable longitudinal fall in the upper section, and flooding occurs beyond the urban border, and (2) have numerous tributaries, such as Kutinska River. Flood retention basin should be provided in the upper sections of the watercourse in order to retain floodwaters and reduce the amount of flow downstream. The availability of undeveloped land next to the urban border facilitates such endeavors, and planned adjacent uses (*Forest, Agriculture*) allow for such development along this stream. Assigning the use “open space - reservation area” in planning documents is essential to safeguard these zones from any kind of future development. Developing wetlands or flood meadows is the suggested planning and design measure for retention basins outside of urban area.

Creating meandering river flow. Widening and deepening the streambed, raising the embankments and removing discharge obstacles are linear flood protection measures that are already envisioned in planning documents for all analyzed streams. However, this research suggests creating meandering river flow for streams of prominent torrential character, such as Kutinska River, Suvodolski Creek, Kovanlučki Creek, Matejevačka River and Humski Creek. In tracing the stream route, the natural course should be favored, as opposed to straight, linear watercourse regulation. This enables better renaturation of the stream and calms the flow during heavy storm events. Additionally, for watercourses with significant slope, control dams are an excellent tool which allows flow deceleration and retention, and prolongs infiltration time. Natural meanders should easily be implemented along the listed streams with torrential issues within the uses *Sport, Protective greenery, Park/Landscape greenery, Recreation, Public square*, but can also be developed within the uses *Agriculture* and *Education*, if open space exists in large complexes of educational use. Displacement of the natural riverbed, which was already performed for Suvobanjski Creek and Brenička River, has resulted in flooding issues of those streams and their tributaries, and should be avoided in future actions. Therefore, the new linear route for the regulation of Suvodolski Creek proposed in planning documents (Figure 1), which alters the stream’s natural course, should be reevaluated, and keeping the natural watercourse route needs to be reconsidered.

Deculverting enclosed/piped streams. The issue of culverts on small urban streams is partly reviewed in planning documents, but only for those short, culverted segments at intersections with the railway or a traffic road. In such cases, increasing the throughput capacity is proposed with widening the culverts or opening new ones. This research further suggests reopening the closed canals of Kovanlučki Creek through the settlement of Niška Banja and creating a more “natural” look for the stream.

Developing natural self-cleaning systems. Strengthening urban ecology and renaturation of small urban streams in Niš territory is a crucial measure for achieving resilience of the city. Given the unknown ecological status of small urban watercourses of the second order in Niš territory, and with week regulations in mind, sampling of these waterways and determining their water quality should be the first step in strengthening urban ecology. This research suggests developing natural self-cleaning systems with various BGI elements as a vital measure in improving water quality along Kutinska River, which has an established poor ecological status. Wetlands, pools and natural settling basins along Kutinska River, as elements of natural self-cleaning systems, could be implemented on available land within the following uses: *Sport, Protective greenery, Industry* and *Agriculture*.

Revitalizing native habitats in the waterfront. Restoring aquatic and terrestrial ecology with native species is the second important step towards the ecological city. Creating new habitats and wildlife in both revitalized watercourses and adjacent urban green spaces is advised for all small urban streams in Niš territory.

Implementing integrated stormwater management approaches and BGI elements. This research suggests implementing bioswales, cleansing biotopes/rain gardens, retention and detention swales and lakes, and infiltration trenches, as natural elements for treating stormwater run-off, in waterfront zones of all selected streams. These BGI elements can be implemented as independent features, or may represent an integral part of a wider entity on adjacent land, such as parks or other recreational areas. If BGI elements for stormwater treatment are implemented individually, then they may be considered in densely built urban areas along the streams, where available space is limited. In this research, it is the case of the lower reaches of Gabrovačka River, Suvodolski Creek throughout settlement Brzi Brod, Kovanlučki Creek throughout settlement Niška Banja, Matejevačka River throughout settlements Matejevac and Donja Vrežina, and both Rujnička River

and Humski Creek throughout settlement Ratko Jović. Linear bioswales can be implemented within watercourse regulation, since they do not require extensive surfaces. This implies remodeling of existing riverbeds that are lined with stone in cement mortar, and renaturation of the streams. The remaining BGI elements may be implemented in areas adjacent to the watercourse, depending on the availability of undeveloped land. In these settlements along the streams, aside from BGI, it is also suggested to use permeable pavement and drywells for collecting and retaining stormwater. These two technical elements for stormwater management, along with infiltration trenches, can also be located within individual plots in the waterfront areas of listed settlements, thus reducing the risk of flooding.

Creating floodable parks and sport-recreation areas. Creating floodable recreational areas in the streams' adjacent surfaces, with various amenities for outdoor activities (playing fields, fitness areas, trails, event spaces, sitting areas, plazas, squares, waterfront decks), is advised in zones of undeveloped land along all selected streams. Given the fact that these recreational areas require more extensive surfaces, BGI and other technical elements of stormwater management may be fitted here. In that way, these zones will also serve as retention areas for flood management. Additional water features would add significant value to the aesthetics of the waterfront. When creating a park environment, it is suggested to introduce both: (1) diverse greenery, within meadows, open grassy areas, flower beds and parks, and (2) additional hydrological features, such as lakes, ponds, dams, canals, rapids and waterfalls. Along analyzed small urban streams, the following potential sites for implementing floodable recreational areas are identified in planning documents:

- Kutinska River: (1) in the settlement Nikola Tesla upstream from the railway, land use *Protective greenery*, and (2) in the upper section of the river in the settlement Nikola Tesla, land use *Sport*, where existing football stadium is located.
- Gabrovačka River: (1) area of existing sport fields in the midstream section (Široke padine street), land use *Sport*, (2) next to the railway, land use *Park/Landscape greenery*, and (3) before the confluence to Nišava River, land use *Recreation*.
- Suvodolski Creek: (1) upstream of the railway in the settlement Suvi Do, land uses *Protective greenery* and *Park/Landscape greenery* and (2) in the upper stream section in the settlement Suvi Do, where sport fields are located, land use *Sport*.
- Kovanlučki and Suvobanjski Creeks: (1) area above the railway (flood hazard zone E), land use *Sport*, and (2) in the midstream of Kovanlučki Creek, throughout settlement Niška Banja, land use *Park/Landscape greenery*.
- Matejevačka and Brenička River: (1) area upstream of the highway (flood hazard zone F) along both Matejevačka River, land use *Protective greenery*, and Brenička River, land use *Recreation*, and (2) area before the confluence with Nišava River in the settlement Donja Vrežina (flood hazard zone G), land use *Protective greenery*.
- Rujnička River and Humski Creek: (1) area along Humski Creek upstream from the highway, in the settlement Donji Komren; since green spaces are limited to very small areas in this densely built settlement, it is advised to use other types of open space that can accommodate flood waters: planned area encompassing open space of a *Kindergarten* complex, open space of a *Healthcare facility*, and *Public square*, and (2) area along Humski Creek, just before merging with Rujnička River, in the settlement Ratko Jović, land use *Sport*, (3) area just before the settlement Šljaka along Rujnička River, land use *Protective greenery*.

These interventions should help in retaining stormwater, and thus with preventing flooding in lower reaches of the stream, particularly in the flood hazard zones A-K established in the MP of Niš (Figure 1). Floodable spaces along Kovanlučki and Suvobanjski Creeks would contribute to stormwater management and enable deculverting of closed canals in Niška Banja.

Developing sustainable mobility routes. Tracing bicycle and pedestrian pathways made of permeable material along all selected streams is a suggested measure. These green-blue linear trails should connect suburban settlements on the stream route with Niš urban area, and should lead all the way down to the main BGI corridor along Nišava River. Inter-linking these pathways to the city transportation network is another important action in achieving sustainable mobility.

Applying flood protection zoning and building codes. In the MP of Niš, most of the flood-endangered sites are already developed, or designated for development, except for localities F (planned as undeveloped) and G (undeveloped, planned for development), both along Matejevačka River. It is assumed that the proposed measures for revitalizing small urban streams would reduce flood hazards. However, when it comes to residential use in the areas prone to flooding, in the cases of selected streams, only low-density areas should be zoned. This implies detached and semi-detached dwellings, to ensure that 60% of plot area will be permeable. Regarding the other uses in

flood hazard zones, it is suggested to prescribe the percentage of green areas and permeable pavement on the plot. Special building codes should also be prescribed, involving wet and dry flood proofing techniques.

This research identified several tools and strategies of **urban design** that enhance the visual appeal of small waterways in Niš urban area. They include a thoughtful lighting plan for the waterfronts, shared streets with generous planting in stream adjacent communities, and a “natural” look for the stream with access to the water itself, where a contact with nature can be reestablished. These solutions should be primarily considered in the densely built settlements Brzi Brod along Suvodolski Creek, Donja Vrežina along Matejevačka River, and Ratko Jović along Humski Creek.

Community engagement needs to be significantly improved in the City of Niš. This involves educating local population on the significance of the streams, raising their ecological awareness, gaining community support through bottom-up approach and promoting waterfront areas as the recreational space for healthy lifestyles. Young population and health professionals should primarily be targeted in promoting campaigns, while designating streams as potential research polygon for local schools and health laboratories. Fostering the City’s inter-company partnerships for stream revitalization projects is necessary. Joint actions imply various stakeholders working together on fulfilling multiple objectives and creating a positive image.

Regarding **risk management**, proper establishing of flood hazard zones is vital, followed by promoting protective measures based on personal responsibility (insurance premiums), as well as developing flood disaster warning systems and contingency plans.

5. CONCLUSION

Contemporary urban planning paradigms regarding watercourses are promoting the strategy of “living with water” rather than defending from it. Under the framework of integrated planning, this shift in vision, policies and urban design techniques points towards a very important role that small urban streams play in urban landscape. This paper discussed the topical issue of flood protection within sustainable development practices, from the perspective of urban planning and design.

In line with the first research aim, it can be stated that the revitalization of small urban streams provides valuable contribution to creating resilient communities. Benefits are achieved regarding flood protection, public health, social life, environmental impacts and adaptation to climate change. Best practice examples that were examined in this paper illustrate how the revitalization of small urban streams improved flood mitigation and stormwater treatment, strengthened urban ecology with better water quality and restored habitats, diversified recreation options, and enhanced visual appeal of the waterfront landscape.

This research also provided an insight into the “blue” capital in small streams of the City of Niš, whose potential is underused within urban planning policy and practice. Regarding the second research aim, the results of this study identified several key planning activities and elements of urban design that should help in retrofitting small urban streams into the existing urban fabric in Niš. Within urban planning measures, special attention should be given to contemporary integrated stormwater management, blue-green infrastructure, parks and recreation areas that serve as flood retention basins, urban ecology, and zoning and building codes in flood hazard zones. This paper also suggested some potential locales where floodable amenities with BGI elements could be applied, but a more detailed examination is necessary regarding their exact locations, size and design. Aside from planning measures, a series of actions is also proposed for profiling Niš as a resilient city, such as upgrading the design of waterfront areas, improving risk management and shifting the perception of the local community. Further studies should focus on creating the BGI grid in Niš territory, which integrates revitalized watercourses and sustainable mobility routes.

Finally, it can be concluded that given the strategic significance of small urban streams in shaping resilient cities, future development of waterfront areas should be guided within an integrated urban planning approach.

ACKNOWLEDGEMENT

This paper is the result of the project “Improving energy characteristics and quality of inner space in buildings of educational institutions in Serbia with the influence on health” (No. III 42008), financed by the Ministry of Education, Science and Technological Development of the Republic of Serbia.

LITERATURE

- [1] “Blue green infrastructure: cloudburst management strategies for the District of Columbia”. Internet: https://doee.dc.gov/sites/default/files/dc/sites/ddoe/service_content/attachments/BGL_Workshop_Final.pdf [Jan. 06, 2020]
- [2] Ramboll. “Strengthening Blue-Green Infrastructure in Our Cities”. Internet: <https://ramboll.com/-/media/38fc23d12a5d47dcb7b3821716d69270.pdf>, 2016 [Jan. 06, 2020]
- [3] R. W. Lammers and C. Day. “Urban river restoration: bringing nature back to cities”. Internet: <https://ibe.colostate.edu/urban-river-restoration/>, 2018 [Sep. 27, 2021]
- [4] M. Dinić Branković, M. Igić, P. Mitković, J. Đekić and I. Bogdanović Protić, “Exploring the potentials of small urban streams in creating blue-green infrastructure in the City of Niš, Serbia“, Proceedings of the International conference on Contemporary Theory and Practice in Construction XIV STEPGRAD, 2020, pp. 159-174.
- [5] Urban Planning Institute of Niš, “Master Plan of Niš 2010-2025”, *Official Gazette of the City of Niš*, no. 43/11, 2011.
- [6] M. Dinić Branković and M. Marković, “Revitalizing small urban streams as an instrument of urban planning in creating resilient cities”, *Facta Universitatis, Series: Architecture and Civil Engineering*, vol. 19, no. 2, pp. 193-205, 2021. <https://doi.org/10.2298/FUACE211203015D>
- [7] “The Streams of Graz Program of Measures 2006-2015”. Internet: <https://www.wasserwirtschaft.steiermark.at/cms/beitrag/10960200/4570309/> [Oct. 21, 2021]
- [8] R. Pinkham, *Daylighting: New Life for Buried Streams*. Rocky Mountain Institute, Old Snowmass, Colorado, 2000.
- [9] “Oslo Reopening Waterways”. Internet: https://ec.europa.eu/environment/europeangreen-capital/wp-content/uploads/2018/05/Oslo_Reopening_Waterways.pdf [Jan. 06, 2020]
- [10] M. Dinić Branković, P. Mitković, I. Bogdanović Protić, M. Igić and J. Đekić, “Bioswales as elements of green infrastructure – foreign practice and possibilities of use in the district of the City of Nis, Serbia“, Proceedings of the 2nd International Conference on Urban Planning, 2018, pp. 347-356.
- [11] <https://www.encyclopedia.com/environment/encyclopedias-almanacs-transcripts-and-maps/best-management-practices> [Jan. 14, 2022]
- [12] <https://www.epa.gov/nps/urban-runoff-low-impact-development> [Jan. 14, 2022]
- [13] <https://www.melbournewater.com.au/building-and-works/stormwater-management/introduction-wsusd> [Jan. 14, 2022]
- [14] <https://www.netregs.org.uk/environmental-topics/water/sustainable-drainage-systems-suds/what-are-sustainable-drainage-systems/> [Jan. 14, 2022]
- [15] L. Liu, O. Fryd and S. Zhang, “Blue-Green Infrastructure for Sustainable Urban Stormwater Management – Lessons from Six Municipality-Led Pilot Projects in Beijing and Copenhagen”, *Water*, vol. 11, no. 10, pp. 2024, Sep. 2019, doi:10.3390/w11102024
- [16] <https://www.northernarchitecture.us/water-management/daylighting-of-alna-river-in-holalokka-oslo.html> [Nov. 9, 2021]
- [17] <http://www.dreiseitl.com/en/portfolio#holalokka> [Jan. 17, 2022]
- [18] S. Burgess. “Development in phytoplankton assemblages, ecological status and purification effect in Teglverksdammen”, Master’s Thesis, Norwegian University of Life Sciences, 2018.
- [19] D. Arnott. “Macroinvertebrate colonisation of a recently deculverted urban stream”. Master’s Thesis, Norwegian University of Life Sciences, 2017.
- [20] <https://una.city/nbs/oslo/bjerkedalen-park-and-reopening-hovin-river> [Nov. 9, 2021]
- [21] <http://www.arquitectes.cat/iframes/paisatge/fitxa/9695> [Jan. 18, 2022]
- [22] <https://landezine.com/arkadien-winnenden-by-atelier-dreiseitl/> [Jan. 19, 2022]
- [23] https://www.greendotawards.com/submit/upload/2007/large/3-460-11_ecological_city.pdf, [Jan. 19, 2022]
- [24] “The Municipality of Oslo, Application for Candidacy to the Landscape Award of the Council of Europe 2016/17”. Internet: <https://rm.coe.int/16806f5e75> [Nov. 3, 2021]
- [25] <https://www.asla.org/2016awards/169669.html> [Jan. 20, 2022]
- [26] Vatrogas Institute. “Report on monitoring the quality of surface waters in the territory of the City of Niš for 2017/2018 - I Quarter”. Internet: <https://www.gu.ni.rs/kvalitet-povrsinskih-voda/?pismo=lat&print=print> [Jan. 28, 2022]
- [27] City of Niš, “Operational plan for flood defense in the City of Niš territory for watercourses of the II order for 2021,” *Official Gazette of the City of Niš*, no. 8/2021, 2021.



Brankica Milojević, University of Banja Luka, brankica.milojevic@aggf.unibl.org

APPLICATION OF THE PRINCIPLES OF INTEGRATED PLANNING IN THE URBAN PLAN OF BANJALUKA 2020–2040 WITH A FOCUS ON THE SUSTAINABLE USE OF NATURAL RESOURCES

Abstract

The application of the principle of integrated planning is the basis of modern planning aimed at sustainable and resilient built environments. It refers to an adequate methodological framework and procedural steps of planning, as well as to the satisfactory general social conditions in which spatial planning takes place, which, especially in transition societies, is still difficult to achieve. Some improvements in this area are, however, possible in practice at the local level. This paper is focused on the sustainable use of natural resources in the urban area of the city, by applying the principles of integrated planning to the example of the Urban Plan of Banja Luka 2020–2040.

Keywords: integrated planning, natural resources, urban plan

ПРИМЈЕНА ПРИНЦИПА ИНТЕГРАЛНОГ ПЛАНИРАЊА У УРБАНИСТИЧКОМ ПЛАНУ БАЊАЛУКЕ 2020-2040 СА ФОКУСОМ НА ОДРЖИВО КОРИШЋЕЊЕ ПРИРОДНИХ РЕСУРСА

Сажетак

Примјена принципа интегралног планирања је основ савременог планирања простора усмјереног ка одрживим и отпорним грађеним срединама. Они се односе на адекватан методолошки оквир и процедуралне кораке планирања, као и на задовољавајуће опште друштвене услове у којима се планирање простора одвија, што је, посебно у транзиционим друштвима, још увијек тешко достићи. Нека унапређења у овом домену су, ипак, могућа у пракси на локалном нивоу. Овај рад је фокусиран на одрживо коришћење природних ресурса на урбаном подручју града примјеном принципа интегралног планирања на примјеру израде Урбанистичког плана Бањалучке 2020–2040.

Кључне ријечи: интегрално планирање, природни ресурси, урбанистички план

1. INTRODUCTION

Natural resources are phenomena, processes or objects in nature that affect constructively or destructively the development of built environments. The basic natural resources are agricultural land, construction land, forests, rocks, minerals, fossil fuels, water, climate, flora and fauna. From the earliest times, man has used them for their potential for development, because the quality of people's lives in the field of housing, nutrition, health, energy production, bioclimatic benefits, comfort, etc. directly depends on them. At the same time, the damage and dangers posed by the uncontrolled use of natural resources, which are manifested through climate change, environmental threats and biological and social risks, indicate another dimension of their impact, which makes it necessary to establish an adequate relationship between human activities and the environment, in aim of mutually sustainable existence.

Uncontrolled industrial development from the 19th century to the 1970s, accompanied by man's insatiable need to make a profit no matter what, had serious consequences for the quality of life of people and the environment in rural and urban areas around the world [1]. They are reflected in excessive pollution of air, water and soil, uncontrolled exploitation of mineral resources, fossil fuels and forests, problems of unbalanced urban development and uncontrolled urbanization in which agricultural land, forest and aquatic ecosystems have become endangered by the permanent expansion of construction land. Intensive economic development and the exploitation of natural resources were accompanied by the uneven development of countries, among which the gap between rich and poor was growing, which was an additional source of potential socio-economic instability and crisis. Therefore, the idea of sustainable development, conceived in the 1970s, has remained relevant to this day, as a guide to a more responsible path for civilization into the future. The interconnection of different aspects of development (social, economic and environmental) pointed to the need for an integrated approach to development, which includes the integrated management and planning of sustainable spatial development, within which it is necessary to achieve the sustainable use of natural resources.

The sustainable use of natural resources, as an important aspect of sustainable spatial development, is especially important for the former Yugoslavia, which underwent major social and political changes during the transition period. The newly formed states (including B&H and its entity The Republic of Srpska) have faced new tendencies dictated by global problems and the demands of the European Union (EU), which has become a major partner and market for natural resources and their products. Since the eco-economy has recently become a leading driver in the development of the European economy, natural resources have become extremely important, because their sustainable use is based on the use of biomass for bioenergy and biofuels – reducing the use of non-renewable energy sources – ecological approaches to food production, harmonized urban and rural development, etc. Some of the recommendations imposed by the EU on these areas are the integrated management of natural resources and integrative and coordinating support for the use of natural resources through an appropriate institutional framework [2].

The sustainable use of natural resources includes their identification, valorization, monitoring, rehabilitation and protection, which are achieved through integrated spatial planning. It is an important mechanism for achieving the sustainability and resilience of the environment [3], which is extremely important in the conditions of climate change and the uneven and mutually uncoordinated development of social and economic processes in the world. An integrated approach to planning integrates spatial-physical, ecological and socio-economic aspects of urban space development into a unique planning model which is inherently very complex, dynamic and changeable. It consists of numerous influencing factors that intertwine in the interactive actions that need to be harmonized in the space. Geerlings and Stead [4] state that integral policies are complex and depend on numerous factors, such as the organizational, individual, political, economic, financial, contextual, process, etc. Therefore, within the framework of integrated planning, which is the basic mechanism for creating a sustainable and resilient built environment [3], it is possible to observe natural resources, whose sustainable use is at the heart of sustainable development. This paper will investigate the application of the principles of integrated planning in the urban area of Banja Luka with a focus on the sustainable use of natural resources in the example of The Urban Plan of Banja Luka 2020–2040, which is currently in the draft phase. The aim of this paper is to point out the possibilities for improving current planning practice, but also the problems in the field of systemic solutions in society that reduce the capacity of integrated planning in the territory of The Republic of Srpska.

2. EXCERPT FROM THE THEORETICAL BASIS OF INTEGRATED PLANNING

Integrated spatial planning is based on the evaluation and improvement of rational planning in the 1950s [5], [6] and comprehensive planning in the following decades of the twentieth century. It is the result of the complex nature of the built environment and overall socio-economic development that require interdisciplinary cooperation [5], united by a unique integrated planning methodology. The built environment has become very dynamic in recent decades [7], [8], [9], which requires adaptability and flexibility in the planning and managing of spatial development. Adaptive management has been successfully implemented in the management of natural resources for decades, while its application in urban planning has encountered numerous difficulties [10]. Flexibility, which is especially important in detailed planning, can be achieved by zoning, instead of rigid regulatory planning [11], which allows the dynamic social, economic and environmental urban context to be more easily included in the planning process [12], [9]. The basic methodological steps in adaptive resource management are problem definition, planning, implementation, monitoring, evaluation and harmonization [2], which the general methodology of integrated planning also accepts. Teriman [13] defined eight steps in an integrated planning approach: (1) redefining problems in the fields of environment, society, economy and institutions; (2) reviewing objectives; (3) reconsideration of alternatives; (4) review of chosen selection; (5) feasibility of development; (6) start of implementation; (7) completion / delivery; and (8) achievement / monitoring. This model offers a sustainability assessment that takes place after steps (4) and (8), as a very important mechanism to control the planning process. From these checkpoints, activities could return to step (1), redefining the problem. It is evident that, defined in this way, the model of integrated planning integrates all aspects of space in all phases of plan development with institutional support in the field of decision making, the implementation of plans and their financing. The whole planning process is accompanied by the active participation of stakeholders (professional bodies, investors, civil sector, etc.). An integrated approach in the process of spatial planning includes the segment of spatial development management as a continuation of strategic planning [13]. In general, strategic planning is process planning and defines the broadest framework of sustainable and resilient socio-economic development and environmental protection with a vision and strategic goals for the long-term planning period. Ahern [14] believes that strategic thinking is necessary at the level of systems for the planning and designing of urban sustainability and resilience in an unbalanced context. The scope of work and the role of planners in integrated planning has become not only professional, but there are also needs for skill in communication and negotiation with stakeholders [15]. The level of development today in the fields of economy, social culture and technology, as well as the built environment, show the lasting complexity and interactive effect of many influencing factors on urban development [1]. The enormous transformations of our cities, societies and the environment over the last few decades have required more efficient and resilient approaches to spatial development planning [7]. This has further emphasized the importance of implementing integrated planning, in order to achieve the goals of sustainability and environmental resilience to the negative impacts of climate change, socio-economic turbulence, rapid urbanization and modern lifestyles.

Due to its complexity, integrated planning that is based not only on the professional capacities of the planners and their negotiation skills, but also on the capacities of the entire social community to enable its application, is still underrepresented. This is especially evident in transition societies [3]. Improvements, however, can be achieved in practice through the development and adoption of quality plans in which actors, especially planners and staff in city administrations, can improve the methodology and procedures of integrated planning. To this end, the subject of analysis in this paper will be The Urban Plan of Banja Luka 2020–2040, which during its development aimed at some improvements in this area, with special reference to the sustainable use of natural resources.

3. RESEARCH METHODOLOGY

The research methodology in this paper was based on identifying the basic principles of integrated planning and recognizing them through the planning methodology applied in the conducting of procedures in the process of the preparation and drafting of the Urban Plan of Banja Luka 2020–2040. The paper will review the legislative, political, institutional and educational support for integrated planning in the city of Banja Luka and The Republic of Srpska, which will help elucidate the topic. In the field of planning methodology, relevant are: a) continuity of planning, b) the spatial information system and database of the plan, c) multi-disciplinarity of planning, e) integration of

data through the phases of the plan, f) adaptability and flexibility of the plan, d) interaction of planning steps, etc. Procedures conducted in the process of the preparation and development of the plan were related to the efficiency and transparency of procedures for the preparation and adoption of the plan, the involvement of professional and public opinions, the professional capacity of city services, etc. General social conditions in the field of institutional, financial, legislative, political and educational support for integrated planning also affect the scope and quality of integrated planning, and the analysis will contain a general overview of these impacts. The method of researching the presence of the principles of integrated planning in the development of The Urban Plan of Banja Luka 2020–2040, with a focus on the sustainable use of natural resources, will be descriptive. The evaluation of the principles will be based on assessment, without the possibility of exact quantification, due to their diversity and character. Despite the limited possibilities in this domain, the research will throw light on the application of integrated planning in practice in The Republic of Srpska, from the aspect of a case study, by pointing out the problems present, and will provide some guidelines for improvements in this area, which can be useful for other local communities, the professional public and relevant institutions.

4. APPLICATION OF THE PRINCIPLE OF INTEGRATED PLANNING IN THE FUNCTION OF THE SUSTAINABLE USE OF NATURAL RESOURCES – EXAMPLE OF THE URBAN PLAN OF BANJA LUKA 2020–2040

The urban plan of the city is a strategic plan that connects the strategic elements of regional development with the urban area of the city, while providing guidelines for detailed regulatory planning. Therefore, among other things, it should rely on the capacities of the natural resources of the urban hinterland and adequately and synergistically include them in the urban system of the city through improving the quality of life, strengthening the urban economy, using renewable energy sources, applying energy efficiency, protecting against climate change, etc. The sustainable use of natural resources is often not adequately included in the planning methodology, so this aspect has especially been focused upon in the process of drafting The Urban Plan of Banja Luka 2020–2040. In order for natural resources to be adequately included in the planning methodology, it is necessary first to define them. Skinner [16] provides a comprehensive definition, according to which natural resources include natural objects and phenomena that are exploited in the present, past and future for direct and indirect consumption; which have the ability to create material wealth, reproduce labor resources, maintain living conditions and increase the quality of life (comfort resources, aesthetic resources).

Natural resources that are relevant to the planning process are land (agricultural, construction and forestry), rocks, minerals and fossil fuels, as well as physiological natural conditions: water, soil, climate, flora and fauna. These factors are contained in the legislation that defines the content of plans in The Republic of Srpska. At the same time, renewable energy sources have not been listed, and nor have maps of landslides and maps of hazards and flood risks, which in climate change are important features of natural conditions that directly affect safety and the quality of life of the population and their economic activities.

The acceptance of natural conditions and the sustainable use of natural resources is directly related to the map of land use and the rules of construction in the urban area of the city. Therefore, special attention has been paid to this aspect of planning within the applied planning methodology in the process of drafting the Urban Plan of Banja Luka 2020–2040. The research also included other principles of integrated planning in the field of applied planning methodology, as well as procedures that accompanied the process of the preparation and development of the plan, including the general social context and legislation.

4.1. CONTINUITY OF PLANNING IN THE URBAN AREA OF BANJA LUKA

Continuity of planning can be achieved by making plans at all spatial levels, without exceeding the planning horizon. At the same time, detailed plans have to be harmonized with strategic plans. There are the Spatial Plan of The Republic of Srpska (Amendments to the Spatial Plan until 2025) and the Spatial Plan of the City of Banja Luka until 2030, which have defined strategic guidelines for the development of urban areas in the context of the wider region. The previous Urban Plan of the city of Banja Luka was adopted in 1975, with a planning horizon until 1990. From 1990 to 2020, there were several attempts to draft a new urban plan, but they failed. In the meantime, many circumstances have drastically changed in the field of urban planning, population size and structure, urban economy, organization of urban activities, including natural conditions, especially in the field

of climate change, agricultural land use, renewable energy sources, etc. In the same period, over 200 detailed regulation plans have been made in the urban area of the city, which did not have an adequate basis in the strategic guidelines for the development of the urban area for the new planning period, because they did not actually exist. Detailed regulation plans followed the current situation and population needs, so they often threatened to jeopardize the goals of the city's strategic development, especially in the field of the protection of public goods, environment and natural resources.

These circumstances indicate the presence of discontinuities in the planning of the urban development of the city due to which the aspect of the sustainable use of the natural resources of the city and the environment was endangered. This was especially worrying, because the city through its historical development has been recognized as a city of greenery, which is the basis of its urban identity to this day. The Urban Plan of Banja Luka 2020–2040 aims to achieve continuity of planning, through a clear spatial implementation of the vision and strategic goals of city development defined by the *Banja Luka City Development Strategy* (2018), as a green city, which emphasizes the importance of the sustainable use of natural resources in urban areas. At the same time, the Plan should provide clear guidelines for updating existing detailed regulation plans, in order to harmonize them with the new urban plan of the city.

4.2. SPATIAL INFORMATION SYSTEM AND DATABASE FOR THE PLAN

The City of Banja Luka has been developing the spatial information system in GIS technology for the last 20 years and contains a significant database (spatial planning documentation, location conditions, building permits, studies, projects, regulatory documents, etc.) which was available for the planning team of the new Urban Plan. A problem in the implementation of integrated planning is an out-of-date real estate cadastre and cadastre of underground infrastructure, whose records are not part of the spatial information system of local government. This fact indicates the institutional disconnection that is necessary in integrated planning. The databases for the Urban Plan of Banja Luka 2020–2040, which referred to natural conditions and resources, were: *Amendments to the Spatial Plan of Republic of Srpska until 2025*, *Spatial Plan of Banja Luka until 2030* and *Urban Plan of Banja Luka 1975–1990*. For the needs of drafting the Urban Plan of Banja Luka 2020–2040, three new studies have been carried out which provided relevant data for the sustainable use of natural resources. Those are:

- *Study of natural conditions and resources in the urban area of the city* (2019). Its goal was to define the input parameters for spatial planning from the point of view of the analysis and valorization of natural conditions and resources in the urban area of the city. They can be important factors in improving the quality of life of the population [16], but also limitations from the point of view of environmental protection, protection from climate change, etc., which directly reflects on strategic commitments related to the purpose and use of space. From the natural conditions in the study were analyzed relief, hydrographic conditions, climatic characteristics, geological characteristics, methodology and assessment of landslide susceptibility, and from the natural resources, forests and forest lands, agricultural land, water resources, biodiversity and geothermal energy. However, no data have been recorded on flood risk and hazard maps, which are, also necessary in planning a sustainable and resilient environment.
- The study *Banja Luka – city of greenery* (2019) which discusses the natural characteristics of the urban area (geology, climate, pedological cover, biodiversity, vegetation and habitats) and their interaction with the green space of the city in order to integrate all of them in the vision of Banja Luka as a green city.
- The study *Implementation of the local nature protection plan* (2019) which focused on nature protection, protected areas and recommendations for the plan.

These studies have significantly improved the database of the plan in the field of natural conditions and resources. In that way, the discontinuity in spatial planning in this domain was partially compensated for, considering the fact that the previous urban plan had a planning horizon until 1990, so many of its determinants were out of date from the point of view of the current state of the urban space. For this reason, in 2019, for the needs of the new urban plan, the following documents were also prepared: *Housing Study*, *Demographic Study*, *Study of Economic Zone Development Possibilities* and *Traffic Analysis*.

4.3. MULTIDISCIPLINARITY

An important criterion for the implementation of integrated planning is the multidisciplinary nature of the planning process, which achieves the comprehensiveness of planning. Multidisciplinary implies the participation of a large number of experts from different disciplines in the planning team. The Law on Spatial Planning and Construction in The Republic of Srpska [17] prescribed the minimum conditions for issuing licenses to legal entities for the preparation of strategic spatial planning documents (including the urban plan of the city). The minimum number of full-time experts in planning companies is 2 graduate engineers of architecture, one graduate civil engineer (traffic orientation), one graduate civil engineer (hydro technical orientation), one graduate traffic engineer, one regional planner, one graduate electrical engineer, one graduate mechanical engineer and one graduate engineer of forestry, landscape architecture or agriculture. All of them must have a personal license to prepare spatial planning documents. The law does not provide for the participation of other disciplines (which in practice usually means that they are not involved in the preparation of spatial planning documentation), which significantly impairs the quality and comprehensiveness of spatial planning. In the case of the sustainable use of natural resources in strategic spatial planning documents, the participation of geologists, ecologists, climatologists and biologists is especially important, as well as surveyors, economists, demographers, sociologists and those of other disciplines relevant to the research of a complex built environment at the urban and regional level.

In the case study of the Urban Plan of Banja Luka 2020–2040, after the public procurement procedure, a consortium of three companies signed the contract with the municipality to draft the plan. Apart from the experts who are legally obliged to draft a plan, they also included in the planning team professionals in the disciplines of ecology, biology, economics, geology, geodesy, geography, mathematics and law. This complemented the planning team and significantly achieved multi-disciplinarity, necessary for a comprehensive and integrated approach to planning. The capacities of the planning team have improved with the engagement of the members of The Plan Council and professional institutions, which were monitoring the development of the plan. This has shown that the application of the principle of integrated planning in a multidisciplinary field can be achieved beyond the legal minimum, if the tender is awarded to the best bidder, from the point of view of professional references and human resources and if the professional public is involved in the plan development process.

4.4. INTEGRATION OF SPATIAL DATA THROUGH ALL PLAN PHASES

The integrity of spatial data refers to their integration and interaction in the sectoral and intersectoral domain through all planning steps defined by the planning methodology. A detailed data analysis that includes all available relevant present information for the plan is especially important. It needs to be further upgraded with planning analyses in every aspect of the space. Natural conditions and resources relevant for spatial planning refer to morphological, hydrological, engineering-geological, engineering-seismological and climatic characteristics and other natural factors of development with the aim of managing, using and protecting natural resources and improving quality of life [17]. Among other things, the plans emphasize the topics of environment protection and measures for the rehabilitation of endangered areas (landslides, floods, devastated, unstable and other lands), as well as preventive measures for protection against earthquakes [17].

In the rulebook on the manner of preparation, content and formation of spatial planning documents in the Republic of Srpska [18] it is stated that “if the spatial planning document covers lands that represent a resource (agriculture, forest and other lands), the graphic part of the plan should contain a) a map of other lands for development and b) a map of credit ratings for those lands in order to determine the basic purpose and compatible purposes in accordance with the classification of that land”. This rulebook creates an obligation for the protection and sustainable use of natural resources through their identification, valorization and appropriate integration into planning solutions. In this domain, it is important to respect the rules in planning practice, which is often not the case. We are witnessing the permanent translation of agricultural and forest land into construction land, which is happening both in spatial planning and in the field of land and cadastral records.

In the case of The Urban Plan of Banja Luka 2020–2040, The Study of Natural Conditions and Resources and the Analysis of the current state of space (planning step) formed the basis for the conceptualization of the land use in the planning period. In accordance with the creditworthiness of agricultural land, parts of the 1st creditworthiness class are integrated into the land use plan as agricultural land, while some are converted into construction land (Fig. 1). Generally, agricultural land, despite all the guidelines for protection and sustainable use, is permanently becoming

construction land in urban areas, which is the case with The Draft of The Urban Plan of Banja Luka 2020–2040.

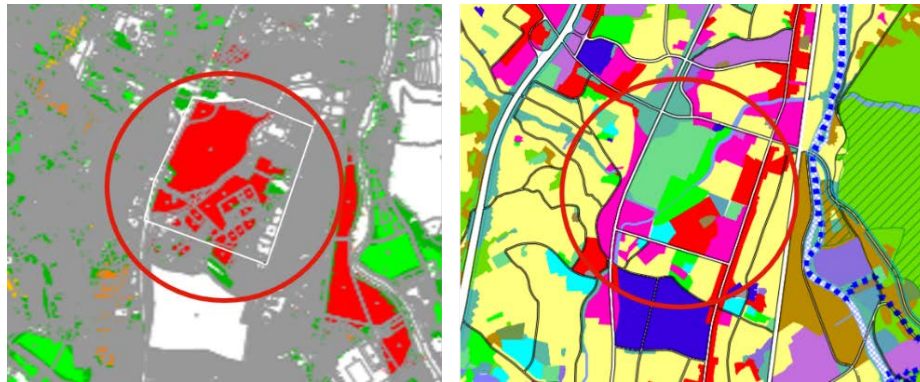

Figure 1. The map on the left side marks the position of 1st creditworthiness class of agricultural land. The map on the right side is of planning land use with the conversion of agricultural land into residential and commercial purposes

Unlike the use of agricultural land, the concept of forest management in the urban area of Banja Luka is reflected, above all, in the protection of forest complexes from permanent change of use. The forests of special purpose are the best in terms of creditworthiness on the maps of the plan. They represent the lungs of the city and are used for active and passive recreation. In addition to the prescribed measures for the purpose of planting, protection and maintenance of the forest, The Draft Plan envisages afforestation of private agricultural land of lower credit rating categories, with appropriate financial mechanisms. According to the plan, the forests of special purpose have been integrated into the city's green space system, which opens up opportunities for urban agriculture (Fig. 2).

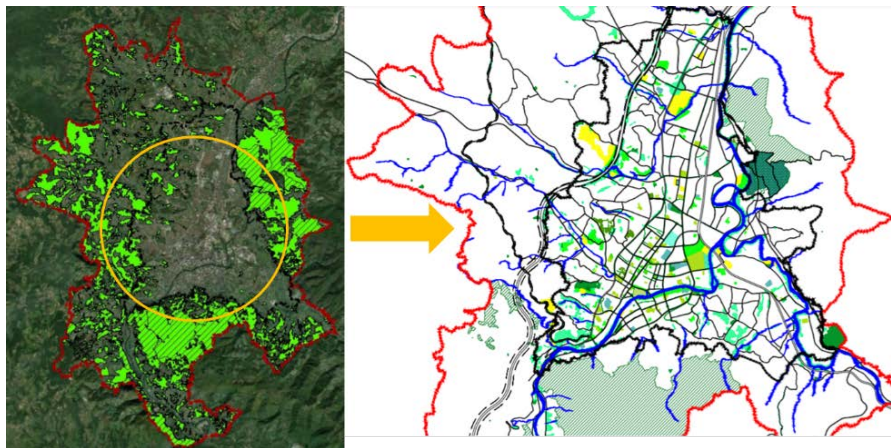

Figure 2. The map on the left side shows the forests surrounding the narrower urban area of the city. The map on the right side shows the system of green spaces of the city which is connected to the forest hinterland.

Beside the forests, The Draft Plan defines the protection of natural heritage in the categories of natural monuments, habitat management areas and protected landscapes, the rules of arrangement, and use and construction on agricultural, forest and water land, which mainly contain measures for the sustainable use and protection of natural resources. The Draft Plan also defines building rules for zones of different purposes, which also contain conditions for arranging green areas. This plan, however, does not provide guidelines for urban design in detailed plans, through the determination of the ecological index in urban areas, which is an integral part of urban regulation in many European cities [19].

In the domain of water land, criteria and rules for landscaping and construction in flood zones have been defined, in order to protect against floods. Flood zones refer to characteristic water levels (medium waters, high waters of 10-year, 100-year and 1000-year rank of occurrence). In these zones, urban and technical protection measures and rules for permitted construction have been prescribed, in relation to the degree of the flood risk. In this domain, there is an evident need to

provide maps of flood risks and hazards, which are an integral part of the database for spatial planning in the most countries, but this is not the case in our region.

The sustainable use of natural resources also refers to the identification, the exploration of potentials and the use of thermal waters in urban areas. Banja Luka has this resource at its disposal, based on preliminary studies, but detailed research in the wider urban area has not been done. Due to that, the thermal waters have not yet entered into the function of the urban development of the city. On the map of mineral resources, the potentials of thermal water have been presented generally in the entire urban area, but the exploitation depends on the specific research locations that need to be defined. The exception is the site in the settlement Srpske Toplice, where there are traces of thermal water exploitation from the Roman period until today. Currently, the research of these potentials is underway for the needs of the construction of a regional spa-center, in a defined research zone.

The Draft Plan defined building rules for the urban area that recommend building safety measures for the ninth seismic hazard zone. These are stricter (previously used) regulations, in relation to the new Seismic Hazard Maps, prepared as a basis for the application of Euro codes on the territory of B&H. This position, which is included as a program task, has been taken from the conclusions of the Round Table on Seismic Activity in the Banja Luka area (2019), as a precautionary measure, with a recommendation to the local government to prepare up-to-date maps of micro-seismic classification. These maps are also missing in the database of the plan, although they are very important, because in 1969 Banja Luka was struck by a devastating earthquake.

4.5. ADAPTABILITY AND FLEXIBILITY OF THE PLAN

Adaptability in integrated planning is necessary to achieve in order to adapt plans to frequent and unpredictable changes, which is inherent in socio-economic processes, the natural environment and the urban environment of today. Adaptive planning and design understand the problem of decision-making in conditions of imperfect knowledge about changes and certain disorders in the future as “opportunities” for “learning through work” [20], which is related to strategies for building urban resilience capacity [14]. The adaptive approach is at the heart of resilience theory, which sees planning and management as a mechanism for resiliently facing different future scenarios, which can be stressful and unexpected. The need for adaptive planning also arises due to the lack of information on the ecosystem, spatial or urban system, which is partly the case with The Urban Plan of Banja Luka 2020–2040.

The management of natural resources has for decades successfully implemented the adaptive approach, while its application in urban planning has encountered numerous difficulties [10]. Within the adaptive planning model, strategic plans can be understood as hypotheses about how a policy or project will affect certain regional processes or functions, and implementation plans become “experiments” from which experts, professionals and decision makers can gain new knowledge through monitoring and analysis.

In the case of The Urban Plan of Banja Luka 2020–2040, it has been noticed that the available database for the plan is directly related to the adaptive approach to planning. In the case of insufficient and out-of-date databases, especially in the field of natural conditions and resources, an adaptive approach should provide a broader framework for defining guidelines for sustainable and resilient urban development in general. The adaptive approach, in addition to planning measures, implies the application of participation, in which planners, in addition to their professional knowledge, must also demonstrate skills of communication and negotiation with stakeholders [15]. The adaptability is achieved by a flexible approach to spatial planning that can include different scenarios for development in the future. The urban plan can achieve flexibility by defining general rules for construction in urban area and guidelines for the implementation of the plan, which has applied partially in the case of The Urban Plan of Banjaluka 2020–2040. However, the flexibility of planning must be enabled through detailed planning, by applying zoning, instead of strict regulatory planning, which in practice is still not present [3]. After the adoption of The Urban Plan of Banjaluka 2020–2040, it is necessary to replace the existing regulatory plans on the urban area with new zoning plans, wherever possible, which offer more flexibility in all spheres of urban regulation [11].

4.6. INTERACTION OF PLANNING STEPS

The interaction of planning steps is a mechanism that provides the essential integration of data in the dynamic process of making a plan. The basic precondition for the realization of this principle of integrated planning is an adequate methodological basis of the planning process, which has been defined in The Republic of Srpska by The Law for Spatial Planning and Construction [17]. Among other things, the law prescribed the basic phases in the development of the plan (preparation of the plan, analysis and assessment of the present condition of spatial arrangement, defining problems and

goals of the plan, and the conceptual phase of the plan). The law also defines the procedures for the expert and public monitoring and verification of the plan (expert discussions and monitoring, public insight and public discussions). It is evident that the law did not clearly define the methodology of integrated planning [3] in relation to the theory of integrated planning [13]. The phases of implementation and monitoring of the plan are not listed in the law and marked as important links in the cyclical process of spatial planning. Therefore, they are being implemented in practice without clear goals and tasks, which reduces the capacity of local government to manage sustainable urban development. For this reason, the possibility of interaction of planning steps, which is necessary in terms of the control, review of compliance and sustainability of planning solutions (especially in the field of use of natural resources), is not legally sufficiently specified. The implementation of this principle is rising to planning practice and local government bodies.

In this case, the expert monitoring of the plan has achieved a significant role in the control and review of planning solutions, through the permanent role of The Council of Plan in the process of its development. Several expert discussions were held on The Preliminary Draft Plan and The Draft Plan, and expert workshops were organized [21]. In the phase of analysis of the current state of development and problems of the urban area, a planning survey was conducted in the local communities. During the public insight, lasting 1.5 months, a public presentation of The Draft Plan was organized, and after that, all the objections of the citizens were analyzed. During the public insight, a public presentation of The Draft Plan was also organized with an emphasis on urban greenery (“Banja Luka – green city”). All these activities were in the function of reviewing and evaluating the planning solution and contributed to the interaction of planning steps, including the aspect of natural conditions and resources. All of that is a positive step forward in relation to the legal framework. In order to achieve a substantial interaction of all steps in the planning process, it is necessary, during the process of its implementation, to achieve permanent monitoring of the impact of the plan on space, especially in the field of the sustainable use of natural resources.

4.7. PROCEDURES OF THE PREPARATION, DRAFTING AND ADOPTION OF THE PLAN

Analyzing the procedures in the process of the preparation, drafting and adoption of the plan entails consideration of their efficiency and transparency, the involvement of the profession and the public, the capacity of the city services responsible for adopting the plan, etc., and falls mainly in the field of the work of local government services. The efficiency of the plan preparation procedure reflects the efficient and competent adoption of The Decision about the initiative to draft the plan. It should be based on and substantiated by the results of the implementation and monitoring of the previous plan, as well as the needs and reasons for drafting a new plan. The Decision should also contain professional guidelines with general information on the planning area, and the basic goals and program tasks of the new planning solution. The quality of The Decision, argumentation and program task largely determines whether the city assembly will adopt the initiative for drafting the new plan, which is directly related to the efficiency of the work of a spatial planning service in the municipality and its professional capacities. The final outcome of this initiative also depends on the political factor, because the councilors in the city assemblies are politically elected, so in The Republic of Srpska, due to the general political circumstances and social environment, the work of the city assemblies is often slowed down or blocked.

The efficiency of the preparation procedure of the plan directly depends on the public procurement procedure (selection of the plan holder). In this domain, a significant problem is the inadequacy of The Law on Public Procurement in B&H [22], which provides for the possibility of appeals and the annulment of tenders, without justified arguments of the appellant. Therefore, the procedure for selecting the holder of the plan often lasts more than a year, which was the case for The Urban Plan of Banjaluka 2020–2040.

The efficiency of the procedures for drafting and adopting the plan depend on the dynamics in determining the phases of the plan, organizing expert monitoring and public participation, verification of phases (control points) and determining the final plan to be submitted to the city assembly for adoption. Possible slowdowns in the plan development process by various actors need to be overcome by the professional and institutional authority of the municipality staff, while strengthening the transparency of work and partnership collaboration with the professional and civil public.

Numerous problems are present in the domain of implementing efficient procedures in the process of drafting the plans on the territory of The Republic of Srpska (reduced professional capacities of the departments for spatial planning in municipalities, reduced capacities of participation, policy impact and systemic problems related to the legislation, etc.). The process of drafting The Urban

Plan of Banja Luka 2020–2040 was accompanied by the satisfactory capacity and support of city services. It was slowed down by too long a public procurement procedure (more than a year) and the removal of political representatives in local government and councilors in The City Assembly, which created a time discontinuity in drafting the plan of more than a year. The overall success of the plan-making procedure will largely depend on the dynamics in determining The Final Plan after public insight and its adoption by The City Assembly of Banjaluka.

4.8. GENERAL SOCIAL CONDITIONS

General social conditions that affect the scope and quality of the application of the principles of integrated planning are related to institutional, financial, legislative, political and educational support for integrated planning. It is evident from the previous text that they permeate almost all principles of integrated planning. In order for essentially implemented integrated planning in practice, adequate institutional support is needed, in the form of cooperation between local government institutions that conduct procedures for preparing, drafting and adopting a plan, and institutions that manage certain spatial data or resources at local and state level. In that domain, there are evident problems that affect the dynamics of development and the quality of the plan, which was somewhat the case with the drafting phases of The Urban Plan of Banja Luka 2020–2040. Financial support for the planning system at the local level is often limited, which directly affects the ability of the municipality to choose the best company by professional capacity, and thus influences the quality of the plan. Fortunately, in this case, it did not happen.

Inadequate legal solutions in the field of spatial planning impede the application of the principle of integrated planning in practice in the fullest capacity. They relate to: defining the general methodology and content of the plan, the content of the informational and documentational basis of the plan, conditions for issuing licenses to legal entities for the preparation of spatial planning documentation, procedures for preparing, drafting, adopting, implementation and monitoring of the plan, etc. Improvements in legislation in these domains would enable a systematic solution to the issue of the comprehensiveness and multidisciplinary of the planning process, define stricter professional capacities of participants in planning, provide an expanded information base, and enable more present public participation and transparency in planning, as well as institutional support for spatial planning.

A very important aspect in the field of the capacity building of integrated planning is the implementation of the systematic education of all actors involved in the process of the planning and management of spatial development. It is especially important to achieve satisfactory education of future experts, urban planners, through curricula at faculties aimed at raising their competencies for understanding and implementing an integrated approach to planning through studying planning methodology, cooperation with other participants in the planning process, and familiarization with legislation and general socio-economic environmental conditions. Education is also needed through lifelong learning in which experts are further educated in the light of new approaches to integrated planning, as well as in the field of strengthening the capacity of civil participation. All these types of education are processes that are developing rather slowly and need to be constantly improved.

5. DISCUSSION

Based on the analysis, it is evident that in the process of the preparation and drafting of The Urban Plan of Banja Luka 2020–2040, the principles of integrated planning were partially applied, primarily thanks to the capacities of the planning team and municipal staff that were involved in the planning process. The database on space had a direct impact on the quality of the plan, which was supplemented in this particular case, especially in the segment of natural conditions and resources, which enabled the integration of this data into planning solutions. Despite the amendments, the available database was, however, insufficient for an integrated approach, especially in the field of resilient planning for climate change, the use of renewable energy sources, the use of thermal waters and the sustainable use of agricultural resources. The spatial information system available to the local government has significantly developed over the last two decades, but the problem of an out-of-date cadastre and cadastre of underground installations is still evident, managed by special institutions that have not connected adequately and efficiently.

The multidisciplinary of the planning process was achieved by including a consortium of three companies that offered professional capacities in a larger number of disciplines than required by law. In this domain, there is the possibility of improving the capacity of integrated planning at the local level, through a responsible process of plan preparation, which occurred in this case. The integration of data was achieved through their mutual interaction and cross-sectoral cooperation, the

goal of which was harmonized planning solutions. They have directly reflected the plan of land use, which should have been based on the harmonization of natural resources and the built environment in aim of achieving the vision of green city development. Discrepancies are possible due to the large amount of data and the complexity of the process of the integrated approach to planning, which in this case was recorded in the example of the treatment of agricultural land, etc. Various mechanisms reduce the extent of non-compliance. In the field of planning techniques, the adaptability and flexibility of planning can amortize poor estimates and enable the plan to be sustainable in the long term. The Draft Plan, by the compatibility of purposes, general rules of construction and guidelines for the implementation of the plan, left the possibility for the flexible and adaptable spatial development of the city in the future.

Detailed regulation plans will play a significant role in this area, which will also have to provide adaptability and flexibility in unforeseen circumstances in the future, without compromising the strategic guidelines of the city's development. To this end, zoning plans have been recommended instead of regulatory plans.

The application of the principles of an integrated approach in the development of the plan was achieved thanks to the expertise of the planning team and the implementation of expert monitoring, through the active participation of The Council of Plan and external consultants as advisory bodies. The staff in The Department of Spatial Planning in Municipality Government professionally managed the procedures in the process of making the plan, which enabled the interactivity of the planning steps. It has been possible to review planning solutions through the several control points (expert discussion of The Preliminary Draft Plan, public presentations of The Draft Plan, public insight into The Draft Plan), through the continuous involvement of The Council of Plan in the plan development process, etc. There was transparency in conducting procedures with the aim of involving the public, but the methods were classic (public participation in public inspection and public presentation of the plan), which is not efficient enough and has a limited domain. Participation should be a continual process of communication between the city administration and citizens, in which citizens are involved in a timely and proactive manner, by giving their proposals, and not just by being informed of ready-made solutions.

6. RECOMMENDATIONS

The drafting of The Urban Plan of Banja Luka 2020–2040 has shown that the principles of integrated planning can be improved in the process of making plans, despite the limits that exist in the domain of planning methodology, procedures, law and general social conditions. It can be improved through the process of drafting the plan at the local level, which is reflected in providing an up-to-date and expanded database of the plan, improving the integrated planning methodology, achieving a comprehensive and multidisciplinary planning process, making interactive planning steps, implementing efficient and transparent procedures, and strengthening public participation.

In the case of drafting The Urban Plan of Banja Luka 2020–2040, the improvement of the principles of integrated planning in most of the mentioned domains was recognized. This is especially important from the aspect of the sustainable use of natural resources, which, mostly, was considered in an integral way through all phases of plan development. This approach represents a necessary step towards sustainable and resilient planning in the light of climate change, the use of sustainable energy sources and the application of energy efficiency in construction, etc. However, limitations have been identified that represent systemic problems that cannot be overcome at the local community level, but need to be addressed by improving legislation at the level of the government of The Republic of Srpska. They include, among other things, defining the procedures of inter-institutional cooperation and exchange of data in planning, defining the mandatory content of the plan, prescribing the minimum conditions for issuing planning permits, the manner of conducting public procurement, etc. In order to improve the system conditions for the implementation of integrated planning in practice, it is necessary to achieve the mutual harmonization of legal solutions in various domains related to spatial development (spatial planning, land records, property relations, natural resources management, energy, etc.), as well as in the field of public procurement. In transition societies, such as The Republic of Srpska, the problem is also the political factor, which often slows down the processes of sustainable development, including in the segment of the efficient adoption of planning documents. Improving the general social environment also entails the need to strengthen the civil sector and participation in the process of urban development, as well as adapting the education system of future urban planners to new requirements in the field of integrated planning.

LITERATURE

- [1] B. Milojevic, *Cities in Changes-Urban Forms, Transformations and Influences*. Banjaluka: Faculty of Architecture, Civil Engineering and Geodesy, University of Banjaluka, 2015, pp. 31–73
- [2] N. Dragovic et al. (Eds.). *Upravljanje prirodnim resursima u Jugoistočnoj Evropi: šume, zemljište i vode*. Skopje: GIZ, 2017, pp. 11–42
- [3] B. Milojevic, “Integrated planning as a mechanism for creating sustainable and resilient settlements”, in *Integrated Urban Planning-Directions, Resources and Territories*. E. Anguillari, B. Dimitrijevic, Eds. Delft: TU Delft, 2018. pp.37–63
- [4] H. Gerlings, D. Stead (2003). “The integration of land use planning, transport and environment in European policy and research”. *Transport policy*. [On-line]. 10, pp. 187–196. Available: https://www.academia.edu/22177003/The_integration_of_land_use_planning_transport_and_environment_in_European_policy_and_research [March 1, 2022]
- [5] ABED. Abukhater (2009, May). “Rethinking planning theory and practice: a glimmer of light for prospects of integrated planning to combat complex urban realities”, *Theoretical and Empirical Researches in Urban Management* [On-line]. 2 (11). pp. 64–79. Available: <http://www.um.ase.ro> [March 3, 2022]
- [6] D. Lawrence. “Planning theories and environmental impact assessment”, *Environmental Impact Assessment Review*, 20(1), pp. 607–625, Dec. 2000.
- [7] S. Pickett, M. Cadenasso, J.Grove. (2004). “Resilient Cities: Meaning, models, and metaphor for integrating the ecological, socio-economic, and planning realms”, *Landscape Urban Planning*. [On-line]. 69(4), pp.369–384. Available: https://www.fs.fed.us/nrs/pubs/jrnl/2004/ne_2004_pickett_001.pdf [March 1, 2022]
- [8] J. Wu. “Landscape ecology, cross-disciplinarily, and sustainability science”, *Landscape Ecology* 21: 1–4, 2006.
- [9] S. Ray. “Rapid urban change demands a theory, tools and a ‘fast forward’ planning – an essay”, in *Fast Forward: City Planning in a Hyper Dynamic Age*, ISOCARP Review 08. Eds. S. Nan, C. Grossop. Perm: ISOCARP, 2012, pp. 14–26. Available: <https://isocarp.org/product/2012-48th-isocarp-congress-permrus> [March 3, 2022]
- [10] N. Rottle, K. Yocom. *Ecological design*. Lausanne: AVA Publishing, 2020.
- [11] D. Counsell et al. “Integrated Spatial Planning: Is it living up to expectations?” *Town and Country Planning*, [On-line]. 75(9), 243–246. Available: www.integratedspatial_planning_is_it_living.pdf [March 3, 2022]
- [12] N. Kosareva, A. Puzanov. “Urban development and urban planning policy in modern Russia”, in *Fast Forward: City Planning in a Hyper Dynamic Age*, ISOCARP Review 08. S. Nan, C. Grossop. Eds. Perm: ISOCARP, 2012, pp. 262–272. Available: <https://isocarp.org/product/2012-48th-isocarp-congress-permrus> [March 3, 2022]
- [13] S. Teriman. “Measuring neighborhood sustainability: a comparative analysis of residential types in Malaysia”, PhD thesis, Queensland University of Technology, Brisbane, 2012. Available. https://eprints.qut.edu.au/54679/1/Suharto_Teriman_Thesis.pdf. [March 3, 2022]
- [14] J. Ahern. “From fail-safe to safe-to-fail: Sustainability and resilience in the new urban world”, *Landscape and Urban Planning*. 100 (2011), 341–343, March 2011.
- [15] T. Yigitcanlar, S. Teriman. “Rethinking sustainable urban development: Towards an integrated planning and development process”, *International Journal of Environmental Science and Technology*, 12(1), pp. 341–352, Jan. 2014.
- [16] B.J. Skinner. *Earth Resources*. New Jersey: Prentice Hall, 1989.
- [17] The Law for Spatial Planning and Construction in The Republic of Srpska. (2013). [On-line]. NN. 40/13. Available: <https://www.vladars.net/sr-Cyrl/Vlada/Ministarstva/mgr/Documents/.pdf> [March 3, 2022]
- [18] The Rulebook on the manner of preparation, content and formation of spatial planning documents in The Republic of Srpska (2013). [On-line]. NN. 69/13. Available: <https://www.vladars.net/sr-Cyrl/Vlada/Ministarstva/mgr/Documents/.pdf> [March 3, 2022]
- [19] A. Mitric-Radulovic. “Ecological index in urban planning”. Internet: <https://www.gradnja.rs/ekoloski-indeks-u-urbanistickom-planiranju-sta-je-to-zapravo-i-cemu-uopste-sluzi/>[March 3, 2022]
- [20] C.S. Holling. *Adaptive Environmental Assessment and Management*. Chichester: J. Wiley & Sons, 1978.

- [21] B. Milojevic, I. Kuvac. “Integrated urban planning of Banjaluka: possibilities and challenges of new urban plan”, Book of Proceedings International scientific conference on contemporary theory and practice in construction XIII [Digital publication], 2018, pp. 352–368.
- [22] The Law on Public Procurement in B&H (2014). [On-line]. NN. 39/14. Available: https://advokat-prnjavorac.com/zakoni/Zakon_o_javnim_nabavkama_BiH.pdf [March 3, 2022]



Saša Čvoro, University of Banja Luka, sasa.cvoro@aggf.unibl.org
Malina Čvoro, University of Banja Luka, malina.cvoro@aggf.unibl.org
Una Okilj, University of Banja Luka, una.umicevic@aggf.unibl.org

ARCHITECTURE AND TECHNOLOGIES AT THE TURN OF THE CENTURY: UNDERSTANDING AND TRANSLATION OF HISTORICAL MATERIAL

Abstract

21st century architecture, in line with the rapid development of technology, could be read through many different architectural expressions and movements in just the first two decades, but they all aim the same - sustainability and energy efficiency. The decade-long process of building the Faculty of Architecture and Civil Engineering in Banja Luka has been presented and tested several times from various aspects of architectural technologies, with energy tasks for the future and response to such targeted requirements. In this paper, the focus is on its roots in conceptual (post) modern architecture in order to understanding and translating the historical material of the ideology of expressive High Tech architecture, all in the context in which this new Faculty building is being created.

Keywords: High Tech architecture, new Faculty building, understanding of historical material

АРХИТЕКТУРА И ТЕХНОЛОГИЈЕ НА ПРЕЛАСКУ ВИЈЕКА: РАЗУМИЈЕВАЊЕ И ПРЕВОД ИСТОРИЈСКОГ МАТЕРИЈАЛА

Сажетак

Архитектура 21. вијека, у складу са убрзаним развојем технологије, у само прве двије деценије могла би се ишчитати кроз различите архитектонске изразе и правце, али сви они дијеле исти задатак - одрживост и енергетску ефикасност. Деценијски процес изградње Архитектонско-грађевинског факултета у Бањој Луци више пута је представљен и тестиран са различитих аспеката архитектонских технологија, са енергетским задацима за будућност и одговором на овако циљане захтјеве. У овом раду фокус је на њеним коренима у концептуалној (пост)модерној архитектури у циљу разумијевања и превода историјског материјала идеологије експресивне High Tech архитектуре а све у контексту у ком ова нова зграда настаје.

Кључне ријечи: High Tech, нова зграда Факултета, разумијевање историјског материјала

1. INTRODUCTION – THE THIRD ARCHITECTURE

High Tech architecture is also known as ‘late modernism’ or ‘structural expressionism’, and as architectural style is the one that incorporates elements from new high-tech industries and advanced construction techniques into building design. It was developed in the 1970s, originally in Britain, and utilised advanced technology and new building materials creating a recognizable image of understanding the idea of high-tech architecture. High Tech is not only expressive of technology, its forms are technically accomplished, as in the case of the Georges Pompidou Center in Paris (1971–77), the first High Tech building to receive worldwide recognition, just like the Eiffel Tower, the Pompidou has become an iconic landmark symbolizing modernity’s celebration of the machine. However, also like the Eiffel Tower, it received much criticism from the academy in its day, despite its immense popularity with the public. [1]

Exploring such avant-garde and experimental architecture, the role of technology and materials in contemporary architecture, utopian spatial models, issues of continuity and evolution in contemporary architecture and, in parallel, working on architectural projects and publishing essays on urbanity, urban culture and architecture, Radović formulated his views on architecture and its social and cultural role and set new boundaries in the rethinking of architectural creativity [2]. According to him "third architecture" architecture takes into account: natural, logical, internal and variable function; technology as a means, not an end, with a careful understanding of new possibilities without subjugation and slavery; history through the understanding and transformation of historical material into completely new harmony, without which there is neither a true vision of history nor a true sense of the present of architecture; nationally as taking the most important and lasting from the regional situation and its context; internationally, so that from the experience of the world and others, the general, the common, the universal, the lasting and the precious are sought; the form obtained through the painstaking search for meaning and splendor in architecture; as well as humanism and user participation in order to establish a real, equal, known and eternal dialogue between construction and those who enable and want it [3].

In this paper, although it inevitably covers more or less other issues set by Radović, the focus is on one question for the “third architecture” - understanding and transformation of historical material into completely new harmony, peculiarly when it comes to new possibilities offered by the accelerated development of architectural technologies. Expressive High tech architecture from the end of the last century marked architectural technologies as the basic motif in contemporary architecture and has its descendants today. The physical and ideological characteristics of high-tech architecture can be defined in the simplest way through the characteristic materials metal and glass, through the alleged adherence to a strict code of honesty in expression, with the idea of industrial production and through strongly emphasized flexibility of use [4]. Question is to what extent have the physical and ideological characteristics survived in these fifty years and in what form do we have them today on the example of the new building of the Faculty of Architecture, Civil Engineering and Geodesy in Banja Luka. The paper is structured, and the above example is analyzed, according to Davis' presentation of High Tech architecture through Function and space flexibility, Materials and (re)construction and Mass production and/or project development, as transmitted and processed by Radović himself, and an additional chapters preface Context and for conclusion Installation systems and why invisible. And as the ultimate goal for this research but for the authors architecture also, could be sad by Radović again as *the search for an integral city of integral people of the integral world, in new social relations, in new material conditions and new artistic categories* [2].

2. CONTEXT

High Tech was not just about prefabricated frameworks and canopies but about integrating all aspects of design—concept, program and construction, as well as urban, social and cultural contexts—at the highest levels of design thinking and project coordination. [1] As the most basic definition High-Tech is a style that rejects traditional methods and aims to develop construction techniques beyond time without forming any associations with past styles. The style aims to control the urban context instead of harmonization with the environment and to create design solutions in a way that gives the feeling that the buildings are not yet completed. In this movement, conventional heavy and bulky monolithic construction systems were rejected; the aim is to transfer the developments in the industry to the building production process. High Tech buildings are characterized as lightweight, flexible and easy-to-build buildings that are renewable, flexible to keep pace with changing conditions, and are built using removable methods. When examining over the

most famous buildings of architects called High Tech fives, (Figure 1) Soyluk concluded that not all and always meet all the criteria defined as characteristic of High Tech architecture [5].

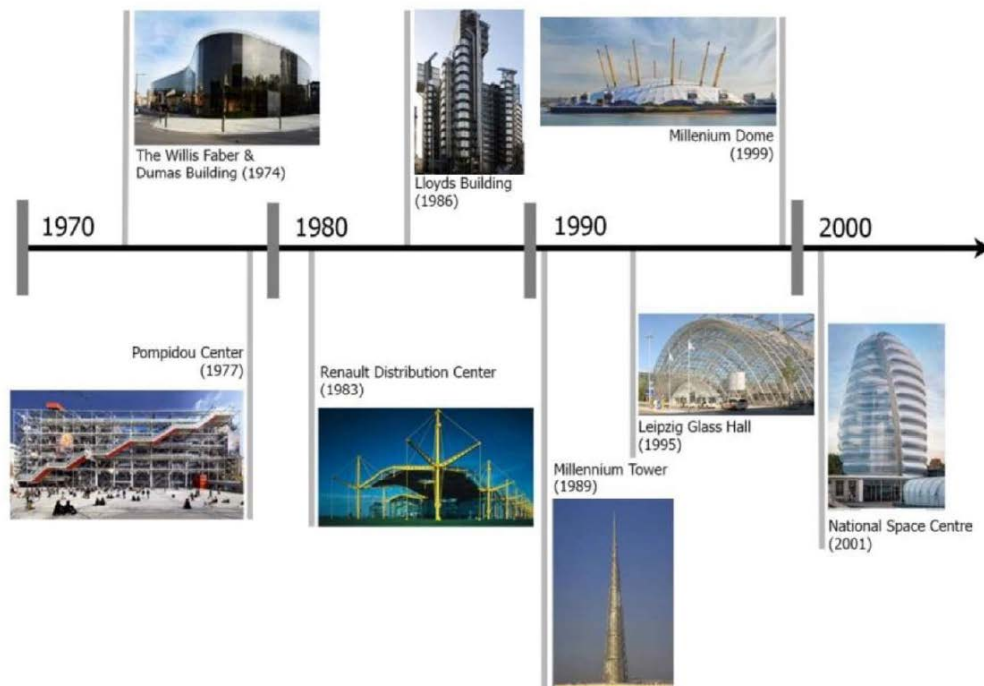

Figure 1. *Timeline of High-Tech Building. According to Soyluk Evaluation just one of these buildings is 100 % High Tech, yet last one meets the specified criteria by 60% [5]*

High Tech architecture moved forward soon which is generally characterized by simplification of form and an absence of applied decoration. Moreover than this, with efforts to reconcile the principles underlying architectural design not only with rapid technological advancement, but also with the modernization of the society, early modern architecture began at the turn of the 20th century. It would take the form of numerous movements, schools of design, and architectural styles, also some in tension with one another. As the result of fast developing technics and technologies on construction field during the period in between 1980's and 2015's, architects started to give attention to concept more than context.

The spatial quality that new school in Banjaluca strived to achieve is inseparability of the building from its context. A modern city implies public spaces which to a large extent remind of indoor space and vice versa, indoor space loses its intimacy due to development of modern technologies. Traditional division on the outside and inside has no longer meaning except that there is an inversion in the view. [6]

The area where the outside crosses to the inside space is roofed over street and at the same time a continuation of the pedestrian alley of the University City to which it is directly connected. There is high density of spatial overlapping, a dynamic hall full of galleries, bridges, perspectives and niches. This is where the encounter between the old and the new, between the sky and the earth take place. The inside street as the area of possibilities unveils itself to us in its entire height giving us the view into everything that is happening within the xybrid old-new. During the day this area absorbs the light and during the night it reflects it toward its surrounding. This kind of concept enables that other users of the University City become participants of the theatrical happening in the hall of the Faculty even though they are not physically present in the building.

Cultural - historical monuments and inherited architectural structures have to be seen as a live organism and vital space for its beneficiaries. Constant changes in functional use, social and political context and economic development are manifested through spatial interventions. They should have a contemporary language signature while historical authenticity and integrity of the location should not be jeopardized. Once harmonized, the inherited structure and contemporary interventions particularly contribute to the value of the urban space and entire ambience as the old and the new add to their value. There are more and more examples of dealing with spatial co-existence of the different with ever rising consciousness that facilities are never finalized, that they continue to live,

change and adapt to the time. [7] Authors tried to keep the quality and to convey the spirit of the existing but with clear marking of the building with the new layer of meaning as the expression of the current time through the transformation of the existing building. The intervention to the 'Tereza' building which included rehabilitation, reconstruction, extension and overbuilding of the existing facility is clearly marked by the dialogue between the old and the new. The aim was to preserve the essential character of the building and to introduce new meaning through transformation in order to accomplish its new functional role and identity.

The existing building with traditional elements of style is connected to the modernly shaped, newly built part of the building. Combination of the old and the new has been offered here as an answer to the aspiration toward acceptance and identification on the part of its new users/students. The volume of the newly built part of the facility is differentiated from the existing building while the defined heights of storeys are being followed very strictly and transferred to the new part of the facility. Architecture of the new Faculty building has been reduced to the container box whereas only the airy hall, the glass cube, connects the new and the old building and represents the higher quality which makes the building special. The entire concept of the school space is focused to this area in-between the old and the new facility and not to the facilities themselves. The zone between the two entities, between the interior and the exterior is active and dynamic space of the hall which enables different relations: it captures the outside space, offers vision into the indoor space and opens toward the nature.

One of the most famous facilities where radically experimental approach in morphological manifestation of the overbuilding has been applied is the Opera House in Lyon, France, made in 1986 by Jean Nouvel, the architect in the old urban center which is on the UNESCO list of cultural heritage and reconstruction and extension of the Tate Modern in London by the Herzog & De Meuron Bureau. Completely modern in its design but in low profile is the Carre d'art Museum at Nimes built in 1993 by Norman Foster and overbuilding of the modern dome on the Reichstag Building in Berlin, in 1999. Very innovative approach has been achieved in extension and decoration of the interior of the Moritzburg Museum in Halle, Germany by Spanish architects, Fuensanta Nieto and Enrique Sobejano in 2008.

3. FUNCTION AND SPACE FLEXIBILITY

In today's world, where technology is at its golden age, examples of High-Tech buildings are encountered in many different regions in the world over time. However, this movement was basically born and developed in England more than fifty years ago. British architects Richard Rogers, Michael Hopkins, Norman Foster, Nicholas Grimshaw and Ian Ritchie are pioneers of this movement. Fosters' Hong Kong Bank was ground breaking on many fronts, but it was especially innovative in its response to program and its approach to the building industry. Fosters pushed the structure and services out to the perimeter, where they could be exposed on the exterior like the Pompidou. In the Lloyd's of London, Rogers too pushed the structure and services out to the exterior, leaving the middle clear for open work space, local circulation and soaring atriums; and in both cases the rationale for this inversion was flexibility. For Rogers and Foster, flex space was important to any given program because it facilitated changes in how the building would be used over time. If we look at the floor plan, of any High Tech example, we see a completely simple and purified space, usually with an atrium in order to further emphasize the lightness of the interior space (Figure 2), which in the end was the meaning of the complicated exterior (Figure 1). The idea is to free up space and make it flexible and adaptable to different purposes and scenarios. Constant changes in functional use, social and political context and economic development are manifested through spatial interventions. They should have a contemporary language signature while historical authenticity and integrity of the location should not be jeopardized. Once harmonized, the inherited structure and contemporary interventions particularly contribute to the value of the urban space and entire ambience as the old and the new add to their value. There are more and more examples of dealing with spatial co-existence of the different with ever rising consciousness that facilities are never finalized, that they continue to live, change and adapt to the time.

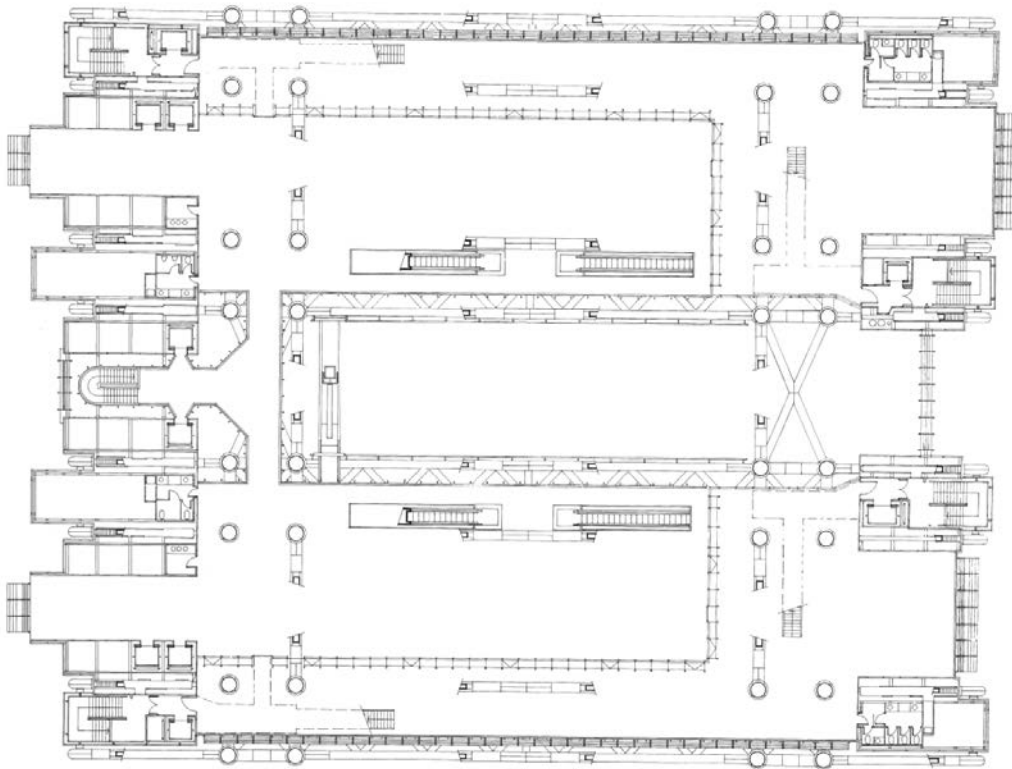

Figure 2. *Foster + Partners, Hong Kong and Shanghai Bank, Hong Kong, China, 1979–86. Atrium plan [1]*

At first glance, there are two most recognizable functional features that connect the new Faculty building with High Tech design. On the one hand, it is the separation of vertical communications, and on the other, flexibility in the organization of the classroom block. (Figure 3) The original, internal vertical communication was moved to the western façade plane of the existing part of the building, leaving vacated space for a more flexible organization. The newly designed staircase thus, in the architectural and constructive sense, represents an independent spatial and design unit. Spatial requirements of the building are defined by the current and the planned number of students and academic courses which take place at three Faculty departments. Having in mind the enrollment policy as well as the variability in the number of students in each department by year, the need to change the number and size of the classrooms themselves was taken into account. Thereby, for being led by the principle which Herman Hertzberger refers to by saying that the task of the architect is not setting of ready-made and perfect solutions but giving possibility to offer the conditions for its upgrading to the beneficiaries and also taking into consideration modern tendencies in academic teaching, there is an intention to improve the conditions for students and professors in the new Faculty building as inspirational laboratory of knowledge. Being aware that there are no given solutions in architecture, the new Faculty building connects seemingly unsolvable tensions in the opposites, searches for the meaning of unclear circumstances in the creative process in our consciousness without the intention to deal with all contradictions at any cost.

The spatial concept of connecting and "reconciling" differences is based on the synthesis of these two cubes with a glazed central hall that extends through all floors in height. The basic design element of the building is the central, covered street, zenithally illuminated, which extends through all floors. There is a high density of spatial overlaps, a dynamic foyer full of galleries, bridges, penetrations, views and niches. This is where the meeting of the old and the new object, the sky and the ground, takes place. The masses of the building are shaped in the simplest possible way, without structural details, except for the sun protection elements which are rhythmic and do not break the unity of the surfaces. Instead of lavish appearance, the requirement of restraint and restraint is respected here. The architectural solution, in a functional sense, naturally imposes the central position of a large amphitheater that defines the basic communication directions within and between buildings. A simple new Faculty building, reduced to only a few design elements, should have the function of a counterpoint in relation to the existing building.

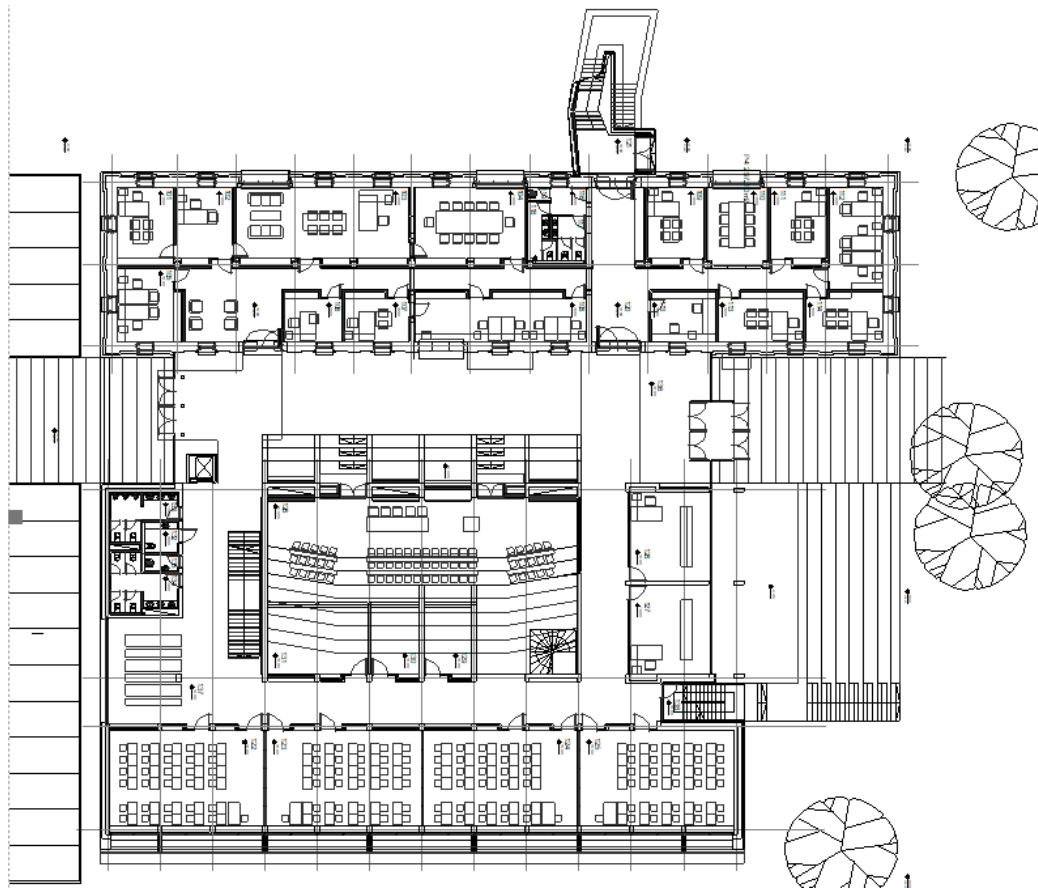

Figure 3. Ground level plan - vertical communications outside the building in the old part of the building on the left and flexible classroom space in the new part of the building on the right (Photo by author)

4. MATERIALS AND (RE)CONSTRUCTION

According to Davis, high tech architecture has its beginnings in the Reliance Controls Factory, the middle and Georges-Pompidou Center and a possible end in two masterpieces HSBC building and Lloyd's building [4]. But it would be a mistake to think that high-tech is a relic of the past: today its legacy exists everywhere in the built world. We meet today various elements - muscular steel construction, smooth unyielding leather, intentionally visible pipes and ventilation ducts, make the appearance of the building extremely complicated and it is perfectly clear what stairs are, what elevators are, and which channels are used for installations. Principles and processes that we now take for granted - such as prefabrication, offsite construction, modular design, factory assembly, computer modeling, mechanical efficiency, information technology, portable buildings, and functional and spatial flexibility - all have their origins in high-tech movement. The influence of high-tech can even be traced in the development of materials such as ETFE and the widespread use of hollow structural sections, which we take for granted in construction today.

Spatial needs in the functional organization of the facility required structural elements of larger spans and the application of non-standard formwork systems. A light skeletal steel was chosen for the structural system of the upgraded part of the building, (Figure 4) which was coupled with a thin reinforced concrete slab. This concept of structural upgrade system, including light internal partitions and cladding, did not significantly affect the existing massive structure of the building. A strong contrast between the old and the new part of building and a clear emphasis on their relationship with the use of materials and the choice of construction. All the glory of the inherited idea of the physical appearance of High Tech architecture is visible both outside and inside the building. Artium, which appears almost regularly in the most important examples of High Tech architecture, here stretches along "the street" that connects the old and the new part on all floors in the form of a glass cube of steel construction. If the Pompidou Center is an example that rounded out the ideas of high tech architecture in some revolutionary parts from the aspect of technology - 'inside-out' building with its structural system, mechanical systems, and circulation exposed on the

exterior of the building [10], we can see new Faculty building in “inside-out-inside” or better “out-inside-out” way. This is precisely because of “the street” set in this way and the importance given to the function and purpose of the building as a “laboratory of knowledge” that communicates in every part with the interior and exterior. (Figure 5)



Figure 4. Steel construction of the upgraded part of the building / future library (Photo by author)

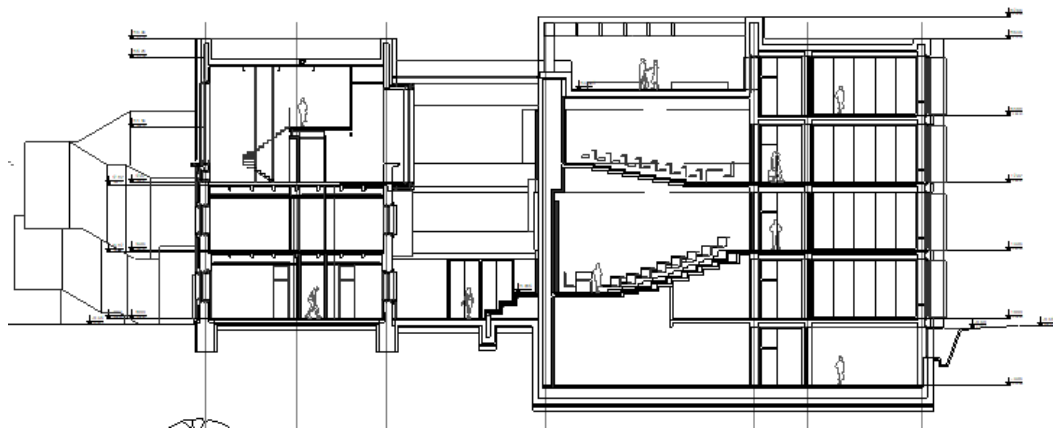

Figure 5. Cross section - steel structure upgraded last floor in the old part on the left and steel structure with glass roof space between the old and new part of the building (Photo by author)

Another feature of High Tech - the belief in truth to materials and methods of construction and the faith in technological innovation [1] [4] is seen on the new Faculty building through design and visual characteristics of concrete surfaces. It is required the definition of the manner of installation of mutual joints and the type of formwork systems, with special reference to concreting work interruptions. The design requirement that the basic structural elements be an integral part of the overall design of the space, conditioned additional requirements in terms of technology of concrete structures, the order of concreting, design of formwork and method of reinforcement of structural elements. For each concrete surface, in accordance with its character (regardless of whether it is a surface or line element), the projected role in the spatial and shape characteristics of the building, the type, texture is defined, and a draft of the formwork is given or agreed on the site all in accordance with the capabilities of the contractor.

5. MASS PRODUCTION AND/OR PROJECT DEVELOPMENT

By far the most important modernist trait that High Tech promoted was the desire to produce buildings out of prefabricated components, and because prefabrication takes place off-site in controlled manufacturing conditions, it allows for precision as well as for quick, on-site erection and assembly. Proponents of high-tech architecture, as well as the pioneers of modernism of the 1920s, believe that there is what is called “Zeitgeist” and that architecture has a moral obligation to express it, and according to high tech architects our age resides in advanced technologies [8]. “Une maison est une machine-à-habiter” by Le Corbusier they saw as primitive and far from machine in technological terms, and for them the machine was much more than a metaphor - a source of technology and art. Machines made of light, precisely made components, manufactured in the factory, mobile and quickly assembled on site, from synthetic materials such as metal, glass, plastic were the benchmarks of this architecture. Although intended to celebrate machine, industry and technological development, in one part of High Tech architecture there was resistance to mass-produced building components being used directly and unmodified. Patented and mass-produced components never seemed to reach the high standards of these architects. It was not uncommon for an architect to collaborate with manufacturers in the development of systems and components. The

best example of such cooperation was building Foster's HSBC. All essential elements of the building, including the structural facade, cladding, service modules, floors, ceilings, partitions and furniture, were designed, developed and tested in collaboration between the architect and the manufacturer. Foster calls this process "project development" [8], which is actually very rare because a significant part of the budget is financed by investors, and it is certain that only in this way it is possible to raise the level of quality and sophistication of construction technology.

Whereas other formative projects standardized components and relied on non-functional flourishes for aesthetic interest, subsequent and more lucrative commissions facilitated one-of-a-kind buildings, where more and more of the components were prototyped, i.e. designed and tested by the architect in close consultation with the manufacturer, and not just prefabricated from standardized parts into larger assemblies. [4] [1] High Tech integrated prefabrication techniques into the industry to the point of reinventing the way things are made. Here the experience of the Pompidou is pivotal: while the interior is unremarkable in its use of off-the-shelf components, the exterior delights with choice cast-steel details. [1] The focus on details like the gerberettes once again underscores the extent to which engineers were involved not only in manufacturing but in the design process.

After pivotal, high-profile projects, such as the Pompidou, the Hongkong Bank and Lloyd's, High Tech has continued to explore new forms and build them at a high level of construction by rethinking the terms of professional practice and by creatively integrating design with manufacturing and engineering. Working in this way meant that the design would change and evolve through a process of interdisciplinary exchange; that an idea would invariably morph as more information about some area of expertise came to light. In addition to the pioneers of the movement, there are some others recognized and described as the new generation of this movement such as Tomas Herzog, Helmut C. Schulitz, Jean Nouvel, Van Gerkan Marg, Itsuko Hasegawa, Ken Yeang [6]. The idea of project development was confirmed through integration of the specialty knowledge of design consultants and manufacturers in what was, a dynamic and unpredictable process. The border of interior and exterior space has been lost, now they are dealing with details with equal attention in the interior, which is far from unremarkable. It's rooted in the modern tradition, for what compels the high level of integration can be boiled down to a fundamental desire to render the logic of how a building works transparent, light and expressive both inside and outside.

The critical interaction between architecture and technology moved from preoccupation with Modernism's logic of mass production, functionalism and fixed tectonics to the introduction of flexible, highly interactive and mutable technologies addressing multiple engineering agendas. Through participation in the development of architectural solutions, project and tender documentation and previous construction of the faculty building, the authors of the project solution, together with associates, tried to define the recognizability of the institution and make a personal contribution to the development of architecture and construction in the country. According to Tabb "high-tech architecture" evolved to blend the daring feats of structural engineering and expanded the tectonic vocabulary to include sustainability. [9]

6. CONCLUSION – INSTALLATION SYSTEMS AND WHY IN(-)VISIBLE

There are strong influences of High Tech architecture in this example, which are not visible at first glance, physical and ideological characteristics can be identified by a more detailed analysis of the project. Davis singled out the basic characteristics of high tech architecture in terms of function, mass production, construction, space flexibility and socket strategy. In this paper, the building of Faculty is presented in accordance with these characteristics, for each of them the question of the existence of traces of ideological heritage and if so, in what form and to what extent. It has been concluded that reasons such as increased comfort expectation, environmental sensitivities and concerns of interacting with the urban context are also effective in transforming the High-Tech trend over time. In addition, although the ideals of High Tech architecture come from the past, their goals are definitely forward-looking and capture the technologies of more advanced industries than building construction technology. In this context, architects, engineers and manufacturers worked in close cooperation during the production of this building. It is thought that this interdisciplinary approach will become stronger in the future.

Spatial quality is achieved by connecting the object with the context. The interior of the house loses its intimacy with the development of modern technologies. The traditional division between outside and inside no longer makes sense except that there is an inversion in the view. The authors design the inner street as a space of possibilities reveals itself to us in all its height, giving us a view of everything that is happening within the hybrid old-new. At the same time, the house draws nature from the environment into itself. During the day, this area absorbs light, and during the night, it

reflects it towards its surroundings. This concept allows other users of the University City to become participants in the events in the hall of the Faculty, even though they are not physically present in the building.

In the end, if we return to our question from the beginning of this paper, the question of "third architecture", we can conclude that the way the authors shaped the new school space has a strong influence of High Tech architecture, but only with moderation in the way Radović taught us. Purpose and function are not neglected for the sake of ideology and glory of technological development, on the contrary, education comes to the fore, exits all pores of the building and connects inside and outside, is in constant communication with the campus respecting the context, while maintaining the possibility of space transformation and open plan. In such setting, there is no place for installations and steel on the facade, the life of the inside-out-inside interspace together with the vertical communications shapes the space, but the installations with characteristic materialization still remain visible in the horizontal distribution under the ceilings or wherever possible with protection from harmful external influences that would endanger them. The way technologies are used is not in their emphasis and they are not an ideological goal, but a means to achieve comfort and efficiency. In this paper, an analysis of one object according to Davis' basic characteristics of High Tech architecture is conducted and the only possible conclusion is that there is a strong influence understandable only through Radić's definition of "third architecture". Such an influence exists, but only to the extent that the historical material understands and translates into a completely new harmony of space, which does not make it neither a true vision of history nor a true sense of the present of architecture.

LITERATURE

- [1] D. R. Ellie Haddad, Ур., „High Tech: Modernism Redux,“ y A Critical History Of Contemporary Architecture 1960 - 2010, Ashgate E-book, 2014, pp. 51-69.
- [2] L. Blagojević, „Ranko Radović: profesor, urbanist, arhitekt i teoretičararhitekture,“ Matica: časopis za društvena pitanja, nauku i kulturu, бр. 48, pp. 379-390, 2011.
- [3] R. Radović, „Posle "čiste" ide hibridna arhitektura ili kako izbjeći obe,“ y Novi vrt i stari kavez, Novi Sad, Stylos, 2005, pp. 55-57.
- [4] C. Davis, „High Tech Architecture,“ y Istorija moderne arhitekture, Beograd, Arhitektonski fakultet, 2005, pp. 459-476.
- [5] Asena Soyluk, „EVALUATION OF HIGH-TECH ARCHITECTURAL MOVEMENT FROM 20TH CENTURY TO TODAY IN TERMS OF CONSTRUCTION MATERIALS AND STRUCTURE,“ y Mimarlık Üzerine-1 , Iksad Publications, 2020, pp. 172-184.
- [6] M. Kordić, Medprostor, Beograd: Zadužbina Andrejević, 2012.
- [7] M. Č. Saša Čvoro, „THE TRANSFORMATION OF THE EXISTING,“ y INTERNATIONAL INTERDISCIPLINARY SCIENTIFIC CONFERENCE RADICAL SPACE IN BETWEEN DISCIPLINES - CONFERENCE PROCEEDINGS, Novi Sad, 2015.
- [8] Norman Foster interview: HSBC headquarters was "more than just a building". [Филм]. Dezeen: <https://www.youtube.com/watch?v=5Yp7tIbz6D8&t=6s>, 2020.
- [9] P. Tabb, „Greening Architecture: The Impact of Sustainability,“ y A Critical History Of Contemporary Architecture 1960 - 2010, D. R. Ellie Haddad, Ур., Ashgate E-book, 2014, pp. 91-115.
- [10] Č. Dženks, „Postsriptum II: Kasnomodernizam i Postmodernizam,“ y Moderni pokreti u arhitekturi, т. VI, Beograd, Građevinska knjiga, 2003, pp. 447-467.
- [11] Richard Rogers interview: Pompidou Centre "captured the revolutionary spirit of 1968". [Филм]. Dezeen: <https://www.youtube.com/watch?v=ug8cUl-xX88>, 2013.



Diana Stupar, University of Banja Luka, diana.stupar@aggf.unibl.org
Jelena Stanković, Ministry of Scientific and Technological Development, Higher Education and Information Society, J.stankovic@mnrvoid.vladars.net
Ivan Živanović, HRTB arhitekter, Oslo, izi@hrtb.no

MAN AND SPACE OF EXCHANGE - STRATEGIES AND TACTICS FOR DESIGNING A MARKETPLACE AS A PLACE FOR EVERYDAY ACTIVITIES

Abstract

The marketplace has been transforming throughout history in relation to typo-morphology, causing changes in socio-spatial relationships negotiated on many levels. The question is: how do different centers of power change the typo-morphology of a marketplace and thus influence everyday social life? In this paper, we try to understand these changes in relationship between a man and a marketplace, where we analyze his position within the space of exchange through strategies of power and everyday tactics. How does a man feel in these types of spaces: is he/she feeling free and protected on the one hand, or isolated on the other? The answer can be seen through exchange of tactics of everyday activities.

Keywords: marketplace, strategies, tactics, dynamic, flexible and adaptable city

ЧОВЈЕК И ПРОСТОР РАЗМЈЕНЕ - СТРАТЕГИЈЕ И ТАКТИКЕ ЗА ДИЗАЈН ПРОСТОРА ТРГОВИНЕ КАО МЈЕСТА СВАКОДНЕВНИХ АКТИВНОСТИ

Сажетак

Мјеста трговине су се кроз историју развијала и трансформисала кроз различите типоморфолошке обрасце у граду, што је изазвало промјене у друштвено-просторним релацијама на многим нивоима. Поставља се питање како центри моћи кроз своје стратегије мијењају типоморфологију простора трговине и на који начин утичу на свакодневни живот друштва. Овај рад се односи на разумијевање таквих промјена у односу између човјека и простора трговине гдје се кроз стратегије моћи и тактике свакодневнице анализира његова позиција у простору размјене. Како се човјек у таквим просторима осјећа: слободан и заштићен или изолован? Одговор се испољава управо кроз тактике свакодневних активности.

Кључне ријечи: простори трговине, стратегије, тактике, динамичан, флексибилан и прилагодљив град

1. MARKETPLACE AS SPATIAL AND SOCIAL CONSTRUCT

In order to understand and construct the social space, firstly it is important to research theoretically the meaning of the term 'marketplace' illustrating its complex, multilayered and multifaceted characteristics. The term marketplace existed since humans first began to engage in trade, but in this paper the word 'marketplace' refers to a way of living which engenders a specific complex of social relationships enabling people to perform their everyday practices. [1:203] In Bourdieu's perspective, a concept of social space called *habitus* refers to not an archeological site but 'a human habitat where people who have the appropriate habitus inhabit it' designating dwelling function to the space. [2:26] Thus, *habitus* is 'a set of dispositions or patterns of perceptions, assimilation and acquisition of objective structures and objective repetition' achieved by combining one disposition with another that the individual develops while performing everyday activities within social space. [2:65] A disposition for social action and engagement is conditioned by individuals' position in a space through engaging in everyday practices. This way, it creates a scheme of perception, thought and action composing different layers of experience being constructed and reconstructed through action of everyday life.

Lefebvre developed further Bourdieu's concept of *habitus* translating it into *habiter* (way of living) always linked to the understandings of social behaviors and everyday activities - 'the processes of dressing, playing, eating'. [3:17] As Lefebvre's *habiter* is not separated from social space, this alludes to his concept of three-dimensional spaces: *perceived* (associating with everyday routine and everyday moving through the space of social activities), *conceived* (through plans, design, drawings and maps created by planners, scientists, urbanists and architects) and *lived space* (everyday space produced by individuals who inherit and act within). According to Lefebvre, the marketplace can be seen as a three-dimensional space showing all the layers of experience. Firstly, it is a 'culture incubator' - space conceived to be used for purchase and sale of provisions, and exchange of goods, etc. [4:175] Secondly, it is 'the locus of a contractual society, the mirror for emulation, the meeting place for diversities' - space perceived by gathering groups of individuals in order to provide a specific demand for commodity and service. [5:10] Lastly, it is an 'urban nucleus' - lived space used for purchase and sale of provisions and exchange of goods, possessing the ultimate form of urban authenticity. [6:85] Lefebvre's dialectics between conceived and lived, highlighting that '(social) space is (social) product' and tool of social reproduction and control, a parallel can be drawn with Heidegger's concepts of *active engagement* in space (*zuhandenheit*) and our *contemplation* of it (*vorhandenheit*) as modes of presencing [7:26] [8:7]

For Heidegger, both things of nature (*vorhandenheit*), as a way of [thinking](#) for a [period](#) of [time](#), and artifacts (*zuhandenheit*), built by human actions and engagement, are necessary for everyday life as a form of cultural production. [8] The marketplace is used as a polygon for analyzing social relations seen as a space in which *vorhandenheit* and *zuhandenheit* overlap. Thus, everyday life encourages social activities and engagement by connecting space and society in order to be able to perceive, conceive and live in it. If we think of space as a spatial construct depending basically on society, endorsing Lefebvre's thought of the production of space within society as it actually is, we can say that the marketplace brings together both space and society in the same global process by exchange of commodities, money and capital. [7] The production of the marketplace is essential to the reproduction of society and to their social space that is produced by embracing everyday life which serves as 'a tool of thought and of actions of society'. [7:26] The question is: how to embrace everyday life in the production of the social space (in this case the marketplace) that 'no longer appears as merely the obscure background of social activity'. [9]

According to de Certeau, the practice of everyday life through the procedures of consumer production has to 'bring to light the models of action characteristic of users whose status as the dominated element in society (a status that does not mean that they are either passive or docile) is concealed by the euphemistic term 'consumers''. [9] There are two approaches defined by de Certeau to act in society: strategy and tactics. The difference between them is seen in the following way: 'strategies are able to produce, tabulate and impose (...) space (...) whereas tactics can only use, manipulate and divert these spaces'. [9:30] Strategies are structures of power - institutions - with a domain of action and decision-making in the production of social space. The power is seen in Mumford's definition of marketplace as 'a product of the securities and regulations of urban life'. [6:71] The realm of routine everyday practices, such as 'ways of operating' or 'arts of doing', are tactical in character intervening within sociocultural space produced and implemented by strategies. [9] Here we can see the relation between power that produces, tabulates and imposes space by its rules, regulations and instructions for use, and powerless individuals who use tactics to create a room for their experiences in settings defined by strategies. Social representation and modes of social

behaviors are enacted by individuals and groups, describing their tactics as metaphors for movements available to each ordinary man. De Certeau is willing to see users being active, emphasizing the fact that 'users make innumerable and infinitesimal transformations of and within the dominant cultural economy in order to adapt it to their own interests and their own rules'. [9] While researching changes and transformation in relation with strategies and tactics - power and powerless individuals - it is necessary to understand their influence on the changes of typomorphology of the marketplace. Through the following historical analysis, the marketplace is seen through its deep dependence on power strategies and the embodiment of commodity money, instead of being observed as a space of exchange of ideas and knowledge and social interaction.

2. THE RELATION OF STRATEGIES AND TACTICS THROUGH HISTORY

A short historical overview is used to show changes of the marketplace typomorphology ranging them from an open-air/extroverted, covered to enclosed/introverted. Based on that, one can see the ways strategies and tactics are embodied in the real environment in which everyday practices and trade take place. In order to understand the relation of production of space by the center of power on the one hand, and powerless individuals who use that space by tactics on the other, it was necessary to research architecture typology and morphological patterns of space of everyday practices and trade. This relation has evolved through history from man's freedom to use the marketplace (open-air/semi-covered - bazaars) to the state where the power is completely dominant over individuals, controlling the way they use the space (creating enclosed department stores and shopping malls). This way, the role of individuals in the use of space was decreased while the power of institutions in production of space became dominant. These powerful strategies have led to the production of enclosed spaces for everyday practices and trade where tactics, seemingly spontaneous and liberating, are in strict hierarchical subordination to governing institutions.

Starting with the first civilizations, the first forms of social spaces i.e. squares as extensions of intersections or covered streets were established, are seen as spaces supporting first forms of trade and intending for freely barter exchange. Streets and squares represent social spaces where tactics of presenting, exchanging and consuming specialized products could be applied spontaneously. However, the term 'trade function', as understood today, was not yet developed, and the term 'international trade' was primarily linked to priesthood as they were the only ones with a privilege to trade abroad. According to Mumford, in parallel to the spontaneous way of trading, an 'ancient form of *supermarket* - within the temple precinct' has been established. [6:72] Strategies used for a trading plan closely linked to the temple symbolize the unbreakable relation between power and trade that can be read in the following historical periods.

In ancient Greece, trade functions were performed on the *agora*, usually positioned close to the temple, bordered by the palace and parliament. Greek *agora* was a meeting place. Ancient Greeks had a casual attitude of trade as exchanging goods was an integral part of everyday life. An introduction to coins has intensified the *agora* trade function to the extent of withdrawing political power from the main square to the inner city areas. The split of trade and political power in Greece is one of the first historical examples of spatial division of trading activities and centers of power. The reason for that lies in the contemptuous attitude of Greek citizens towards merchants. Understanding trade, as a lower rank activity according to Jacques Ellul, where trade is explained as a consequence of division between science and techniques embodied in Greek society, originated from the way of understanding life in which they despise material needs, discredit manual labor, refuse using force and they respect nature. [10:42] Interestingly, the humiliated and expelled merchants have never received official citizen status. The spatial concept of trading can be understood independently of political power, embodied by tactics of exchanging goods and opinions in Greece *agora*. As a social space, the *agora* is used as the platform for living, engaging and spontaneous social interaction.

Different from Greek society, the Romans in accordance with their enterprising and efficient nature, accepted that trading and merchants had an important role in Roman society. For that reason, *Trajan's forum* in Rome was built, consisting of a sequence of open and enclosed social spaces. The forum within which, next to the commercial premises, the impressive Trajan's Palace, two libraries, temple, the Triumphal arch and the Trajan's Column with a bronze statue of a governor on the top were located. The strategy of unbreakable and hierarchical relations between governors, politics, education, religion and trading was established by building *Trajan's forum*. Social spaces of *Trajan's forum* in which trade and everyday life take place are composed of numerous premises with different functions gathered under the same roof. Compared with contemporary *shopping malls*

(Fig.1). *Trajan's forum* showed the improvement in building a porch marketplace with impressive colonnades by protecting it from weather conditions. This is the first indication of contemporary syndrome called *comfortable shopping* (all everyday activities under the same roof). This way, a controlled top-down space for *comfortable shopping* was created, within which tactics by individuals were minimized, strengthening *Trajan's* strategies. Thus, strategies - power - and tactics - powerless individuals - were located in the same social space manifesting a hierarchical mechanism that controls everyday life occurring under the same roof.

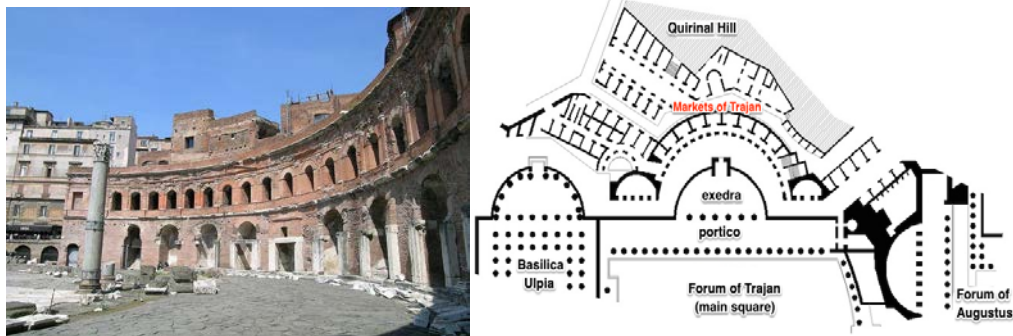

Figure 1. *Trajan's forum, and Plan of the Trajan's Markets, 2nd century, Rome*

After the fall of the Roman Empire, Christian communities were grouped within monasteries and city-fortresses, where the disorderly 'without social and political organization' ruled. [10:57] In moral perspective, the Christianity condemned luxury and money. In accordance with that, medieval marketplaces were placed outside of the fortress, and later by strengthening merchant positions, the city expanded to the areas encompassing newly built trading spaces. Street trading became a basic trading tactic. Strengthening trade guilds - groups of craft people united to achieve their rights - enabling the trade to reoccupy the central city zone, settling close to the center of power - the City Assembly. The people traded in the City Assembly, at squares and in streets with craft activities. The attitudes of society towards work have changed leading to the expansion of craft in numerous city households in which there was a division between the living space (upstairs) and the space for production and trade (downstairs). While trade guilds were concentrated to facilitate their techniques in the production of artifacts within its community, hiding their knowledge from others, some merchants, being aware of the advantages of international trade, developed modest techniques for massive production. Trade guilds formed at a local level began to feel powerless, and new types of merchants - entrepreneurs - have acquired artificial financial wealth by controlling international trade. [6:292] The reflection of social circumstances on the marketplace occurred again, starting with weak connection between political power and trade from the beginning of medieval century, where tactics dominantly formed trading streets, ending with the predominance of international trade and its direct connection with politics, forming *bazaars* unifying political power and trade under the same roof. Tactics of spontaneous gathering and trading became more and more powerless in the future being founded on the principle of spatial decentralization and strong hierarchical strategy.



Figure 2. *London's Pantheon Bazaar, 1845*

Since the seventeenth century, there was a massive change of the purpose and function of craft workshops transforming them into shops with serial production of goods. The craftsman is finally separated from the process of making the artifact. Being unable to compete with international resellers and traders, he is forced to produce for a remote anonymous market, or to suspend his production. New trading strategy emerged, having power over consumers' tactics and their everyday activities. In this relation of strategies and tactics, the seller became the hunter and the consumer was the prey, both closed in the mechanism of trading with goods of unknown quality. Wealthy entrepreneurs controlled serial production and consumption from their administrative headquarters. There is a need for the transition of squares and specialized shops into a new form of enclosed multifunctional halls *bazaars* with various goods displayed on counters (Fig.2). New completely enclosed *bazaars* are built to protect consumers and goods from the weather, enabling consumers to comfortably buy goods of unknown quality. *Bazaars*, as a precursor of shopping malls, were ruled by strategies - the power of political and trading elites - being responsible to control and distribute goods within *bazaars*. The political power was relocated outside *bazaars* to the city central district where the centers of power were physically separated from the luxurious activities of leisure, well-being and shopping.



Figure 3. Parisian Department store *Le Bon Marché*, 1852.

The era of capitalist industrialisation has radically changed social space and everyday life within which commodification has overpowered the value of artifacts. The distribution of goods to the marketplace became one of the principal actions. The new consumer society designates social space as an enclosed *department store* in which the reign of comfort and abundance of goods gathered under the same roof (Fig. 3). The *department store* has been located in the central city district, becoming an iconic building of every city by establishing a framework for the upcoming culture of consumer society. The administrative center originally located within industrial suburbs has been moved to new business city zones followed by a new architecture of skyscrapers alluding to Trajan's columns in a way that their connection with the center of power has been hidden and seemingly detached. The same case is with *the department store* where there is evident physical distancing of administrative districts in relation to them but at the same time, it has been strengthening the strategy of tracking money flows by the power-ruling elite. The enclosed system of comfortable trading in enclosed architecture structures started being a predominant form of controlling society and its everyday activities.

In the mid-20th century, the pollution and overcrowding of city quarters encouraged massive suburban settlements. In the same time period, primarily in American suburbs detached from the city business district, there was a new form of social space called *shopping malls* - 'everything under one roof' (Fig. 4). Seen as an anti-urban form surrounded by endless rows of parked cars, *shopping malls* unified both trade and spectacle. The creator of the first *shopping mall* is considered to be an Austrian architect, Victor Gruen, whose noble vision enabled American suburban families to finally create a social space. However, as Gruen stated, his 'social spaces' are actually strictly controlled and secured private spaces, and that 'social event' is programmed space whose sole purpose is to entice as many consumers of different ages and wallet depths.



Figure 4. Southdale Shopping Mall, 1956, Minneapolis

By the end of the 20th century, large and massive *shopping malls* began to spread rapidly across Europe. The conclusion of one article called 'The Terrazzo Jungle' in *The New Yorker* stated: Victor Gruen designed the enclosed *shopping mall* with an intention of making America more similar to Wien and eventually Wien began to resemble America. [11:6] Parallel to the development of the new anti-urban forms of *shopping malls* in the suburbs, the historical city, especially in metropolis, has become a scene for tourists. Since the time of ancient civilizations, the squares and streets have been social spaces for daily encounters but gradually they have lost this primary function. This transformation of the city nucleus has led to the displacement of trade into enclosed and air conditioned spaces that no longer belong to its citizens. In his book *The Prospect of Cities*, John Friedmann claims that American streets have completely lost their meaning and role in the socio-historical context and that they became runways for efficient traveling between two shopping malls. According to Friedmann, there are only two occasions when people take the streets: when protesting against authority and when celebrating. [12] Despite the fact that city nucleus including the streets have lost their primary function - to bring people together at the same place, the possibility of these spontaneous occasions is exactly what brings back their lost function of social spaces. The strategy is manifested through enclosed forms of the marketplace (e.g. department stores and shopping malls) showing that tactics seen spontaneously and liberating are in strict hierarchical subordination of displaced centers of power.

2.1 THE DOMINATION OF STRATEGIES - A MAN IS POWERLESS

Through the historical analysis of the marketplace typo-morphology (ranging it from an open-air, covered to completely enclosed space), it was aimed to show the changes in relation between strategy and tactics that occurred and their influence on today causing complete domination of strategy over powerless individuals. The marketplace transformation is not a linear process mutating from one architectural type to another, but all types have existed in parallel, even today, appearing simultaneously in the historical city or in their contemporary suburbs. The historical analysis is used to define the typo-morphology of the marketplace: seen as an anti-urban type composed of all previous-mentioned types and facing themselves, not the city – introverted (Fig. 5) According to this, the relation between strategies and tactics have varied through history of the marketplace: at first, spontaneous tactics used for trading were developed, then by strengthening the center of power under control of the church, tactics started decreasing; this relation faded in ancient Greece by the domination of tactics on squares and agoras; in Rome, Trajan emphasized the domination of power; in medieval century, the decrease of power and spontaneous creating street trading was evident, which ended with bazaar as a palace of luxury; and the creation of department stores and shopping malls - physically displaced the center of power - have increasingly controlled the flows of centralisation, globalization and global disinterest of society. The paradox of analyzing the marketplace through history shows that strengthening power and its complete centralization is inversely proportional to everyday activities. The position of a man as a social human being in the process from production to consumerization has been completely marginalized. Society gathered around the desire for improving their way of living has accepted consumer life, being preoccupied with freedom of choice in the world exposed by numerous opportunities for enjoyment and happy life. As freedom of choice is individual, in his book called *Work Consumerism and the New Poor*,

Bauman stated trade as a non-social act adding that consumer acts are opposite to manufacturer's acts as they are together while making. [13:31]

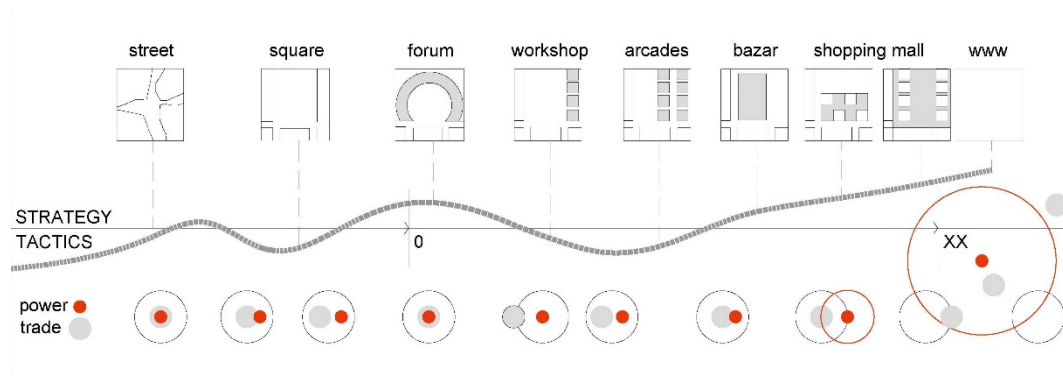

Figure 5. *The changes of the typo-morphology of the marketplace through history*

The introverted and marginalized position of a man in the process from production to consumerization is enhanced by the development of digital technologies and pandemic COVID-19. The digitalisation and virtualisation of the 21st century supported by the development of technology and social networks continue to revitalize the marketplace in a way that social spaces are substituted with the screens. The citizen engagement is limited to one click on the keyboard while human interaction is founded on virtual contacts. Giddens noticed a phenomenon of human disinterest by analyzing the beginning of the 21st century. He added that disinterest is not the same as completely ignoring the other person but each individual being aware of the presence of the other avoiding any gesture that could be interpreted as excessive intrusion. [14] Giddens considers the trends of further and more intensive human alienation caused by digital interaction, in order to emphasize the importance of a real interlocutor in everyday communication. According to Giddens, no matter how many direct virtual contacts we make by using digital devices, the close presence of interlocutors in everyday communication even in the most developed society remains crucial. [14] The virtualisation of everyday life and the marketplace confirm the domination of the global center of power to the point where tactics are abolished. The question is: where is the center of power today? If the city represents the economic and social world, and such a world can be observed through the relationship between power and trade, it can be concluded that their physical distance, today located at the center of local and global conflicts, is essentially a deception. It is evident that the center of power is the virtual world that rules real life and everyday activities.

Where are we living today, in an era of social distancing in public spaces, imposed by Covid-19 pandemic? The virtualization of real life and everyday activities reaches its peak during this period. In terms of human security, the dominant center of power suppressed real life, isolating human beings from social interaction. [15] The imposed restrictions on daily life by Covid-19 including social-distancing and ban on performing everyday activities, devastated the city urban spaces. [16] The traditional marketplace ranging from squares and streets to shopping malls is substituted with the virtual space of exchange (online shopping) overnight. Thus, online shopping located in the gap between local and global conflicts does not have any material characteristics showing that it has neither an identity nor connection with the inhabitants, nor any connection with the local context and urban space.

Now what shall we do?

3. MAN IS IN THE CENTER-EVERYONE ON THE STREET

The 21st century brings changes in the production of social space in two directions. The changes are seen as the potential to redesign the human dimensions of social space founded on small-scale tactics on the one hand, or total loss and collapse of social space on the other. The marketplace i.e. the public space is dead because of lack of connection between strategy and tactics i.e. 'top-down' and 'bottom-up' approach is observed and used separately by urban planners and decision-makers despite the fact that both are important for the redesign of the marketplace itself. 'Top-down' approach is founded on utopian concepts of permanence created in a time of intensive urbanization supported by massive plans, permanent solutions and lasting results - the dream of permanence. It reflects the power of the City Council and authorities in decision making and planning of urban interventions where initiatives are solved in the long term. These initiatives refer to large-scale projects without consideration of tactics - citizen engagement in the everyday life of the marketplace.

'Bottom-up' approach is based on the 'The Theory of Communicative Action', German philosopher and sociologist Jürgen Habermas, producing the term collaborative planning - the domination of tactics. [17:3] The importance is in the dialogue as 'the fundamental human need to share, to communicate, to connect with other living beings, and to leave a deep impression on them' focusing on the tactics in everyday life. [18] Tactics have started from 'small' actors, organizations or individuals, taking themes from everyday life and working on local projects as a way of responding to economic, environmental, political and social issues.

The contemporary principles founded on theoretical approaches and practices of public space are used to make a balance between strategy and tactics i.e. 'top-down' and 'bottom-up' approach 'unlocking the potential of sites now, rather than in 10 years' time'. [19:3] The principles of the redesign of social spaces refers to both the redesign process (*democratically, temporary and adaptability, everyday and simultaneously*), and the redesign result (*massive small, identity*) (Fig 6). [19, 20, 21, 22, 23] Establishing a dialogue between strategy and tactics from the bottom to the top in a way that the link between strategy and public space is loosened, enables engagement in human-human interaction. The focus is on short-term, temporary/adaptable and everyday tactics for redesign of public spaces responding to society's requirement to be efficient, cheap and economical. Public spaces selected for redesign have to be massively small and uncontrolled by the power of strategy in which organizing different events becomes a serious potential of sheltering everyday tactics. [24] These spaces are the only ones that can bring back humanity through social engagement in real space, from the bottom to the top. If we follow the life cycle then there is a need to return to small-scale marketplace with a modest budget, short deadlines and accelerated procedures creating dynamic, flexible and adaptable urbanism that keeps up with the changes of socio-spatial relationships caused by COVID-19.

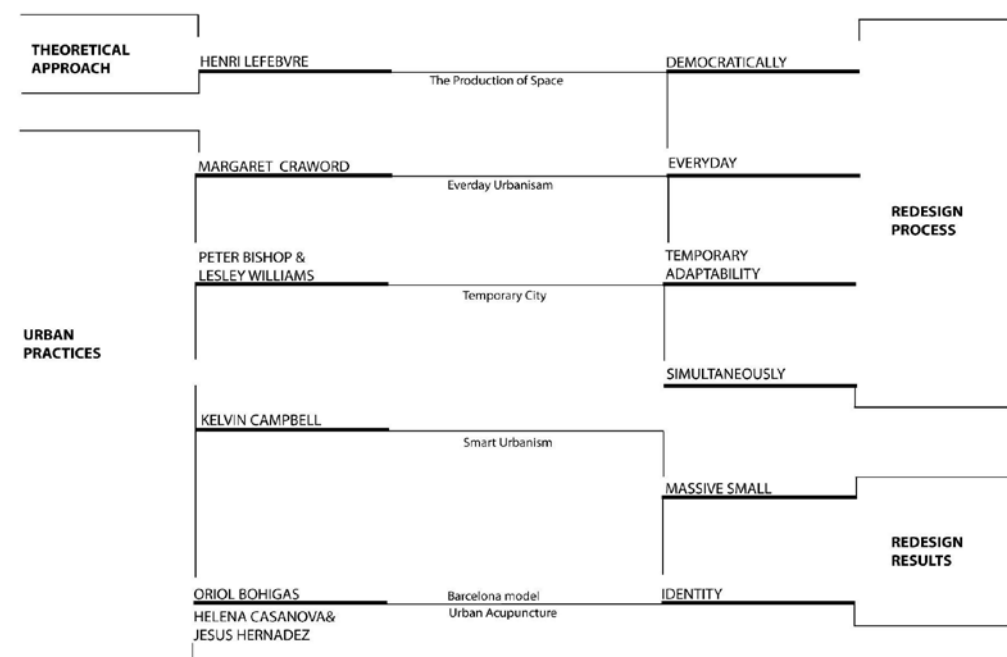

Figure 6. The contemporary principles on theoretical approaches and practices of public spaces

It is the strategy power that will govern everyday life, no matter the distance between power and space. As centralisation and domination of power strategies fade, everyday life tactics become more alive and efficient. This makes the physical position of power irrelevant, since it is centralisation and globalization that decide how dominant power is. Their influence is formed and decided in public spaces. Systematic expansion of these spaces shows that production in strategic locations, more or less close to centers of economic power, does not depend on the location alone. To conclude, even though we discuss the expansion in a spatial and physical context, the goal of this expansion is to connect dominant differences on a global and local level, with an aim to strengthen the metropolis itself.

The contemporary principles and practices of designing a public space, based on the dynamic, flexible and adaptable city, shows there is a way to balance the domination of strategies. Weak connection between strategies of power and tactics of everyday is the one that develops positive social interaction. According to Ardent, 'what makes mass society so difficult to bear is not the number of people', but the fact that the world 'lost its power to gather them together'. [25:53] The marketplace researched through history can be used as the one remaining tactic crucial for redesign and reactivation of social spaces, thus connecting people. Marketplace as a form of public space enable the citizens to be heard and seen through social engagement, participation and activation in the production of social space, bringing back users of space in the center.

LITERATURE

- [1] E. Ünlü-Yucesoy, "Constructing the Marketplace: A Socio-Spatial Analysis of Past Marketplaces of Istanbul", *Built Environment*, vol.39, no. 2 (2013): pp.190–20., 2013.
- [2] P. Bourdieu, *Habitus and Field, General Sociology, Volume 2, Lectures at the College de France (1982-1983)*, eds. Patrick Champagne, Julien Duval, Franck Poupeau and Marie-Christine Riveiere. Polity Press, 2020
- [3] H. Lefebvre, *Writing on Cities*, translated and edited by Eleonore Kofmana and Elizabeth Lebas. Oxford and Massachusetts. Blackwell Publishers Ltd, 2000.
- [4] M. Carmona & S. Tiesdell, *Urban Design Reader*. Routledge, 2007.
- [5] C. Abrams, *Man's Struggle for Shelter in an Urbanizing World*, MIT press, 1966.
- [6] L. Mumford, *The City in History: its Origins, its Transformations and its Prospects*. New York: Harcourt Brace Jovanovich, INC, 1961
- [7] H. Lefebvre, *The Production of Space*. Oxford, UK & Cambridge, USA: Blackwell, 1991.
- [8] M. Heidegger, *On time and being*. University Chicago Press, 2002.
- [9] M. De Certeau, *The Practice of Everyday Life*, trans. by Steven Rendall. Berkeley and Los Angeles, California: University of California Press, 1988.
- [10] J. Ellul, *Tehnika - ili ulog veka*, Beograd: Anarhija/blok 45, 2010.
- [11] M. Gladwell, *Terazzo Jungle*, *The New Yorker*, (March 15, 2004.), pp. 6-9. http://www.newyorker.com/archive/2004/03/15/040315fa_fact1?currentPage=6
- [12] J. Friedmann, *The Prospect of Cities*. Minneapolis: University of Minnesota, 2002.
- [13] Z. Bauman, *Work Consumerism and the New Poor*, Berkšir: Open University Press, 2005.
- [14] A. Giddens, *Sociologija*. Podgorica: Biblioteka Universitas, 2001.
- [15] A. M. Salama, "Coronavirus questions that will not go away : interrogating urban and socio-spatial implications of COVID-19 measures", *Emerald Open Res*, 2020.
- [16] N. a. Megaheda. E.M. Ghoneim, "Antivirus-built environment: Lessons learned from Covid-19 pandemic", *Sustainable Cities and Society*, Vol 61, 2020.
- [17] J. Habermas, *The Theory of Communicative action*, Baecon Press, 1985.
- [18] K. Pogačar, "Urban Activator– Participatory and Bottom-Up Tool of Urban Change: Definition and Selected Examples". *Prostor* 22, 2014, pp. 188-199.
- [19] P. Bishop & L. Williams, *The Temporary City*. London and New York: Routledge, Taylor & Francis Group, 2012.
- [20] O. Bohigas, "Strategic Metastasis", in *Barcelona: Spaces and Sculptures (1982-1986)*. Barcelona: Ajuntament de Barcelona, (Area of Urbanism and Public works and Joan Miro Foundation, 1987), 11-24.
- [21] C. J. Leighton, M. Crawford and J. Kalinski, eds. *Everyday Urbanism*. New York: The Monacelli Press, 2008.
- [22] M. Solà-Morales, *De cosas urbanas*. Barcelona: Gustavo Gili, 2008.
- [23] H. Casanova & J. Hernadez, *Public Space Acupuncture: Strategies and interventions for activating urban life*. New York: Actar Publishers, 2014.
- [24] J. Stankovic, I. Karan, T. Trkulja & D. Aleksic, *Male intervencije u prostoru/metodologija: Studija za aktiviranje potencijala javnih prostora Banja Luka*, ured. Milenko Stankovic & Diana Stupar. Banja Luka: Arhitektonsko-građevinsko- geodetski fakultet Univerziteta u Banjoj Luci i Grad Banja Luka, 2020.
- [25] H. Arendt, *The Human Condition*, Chicago and London: The University of Chicago Press, 1998.



Jasna Guzijan, University of Banja Luka, jasna.guzijan@aggf.unibl.org
Siniša Cvijić, PhD candidat at Graz University of Technology, sinisacviji77@gmail.com

CULTURE OF MEMORY AND HERITAGE AS A STRONG CONNECTION – A CASE OF MONASTERY OF THE HOLY ARCHANGELS IN PRIZREN

Abstract

The paper researches monasteries as special “places” that are culture bearers from the Middle Ages – when this type of religious community was established – to the present day. They are strongly embedded in the identity of a nation in a way that they have all characteristics of tangible and intangible heritage. The paper researches a relationship that monasteries have as a point of gathering, culture preservation, customs and tradition, which contributes to building knowledge about the manner of living in past centuries. A case study, which was used to explore the role of monasteries in a collective memory and fostering of Serbian cultural heritage, relates to the Monastery of the Holy Archangels in Prizren which was an important pillar of Serbian medieval culture.

Keywords: Cultural heritage; cultural memory; (in)tangible values; monasteries, Prizren

КУЛТУРА ПАМЋЕЊА И НАСЛЕЂЕ КАО ЧВРСТА ВЕЗА – ПРИМЕР МАНАСТИРА СВЕТИ АРХАНЂЕЛИ КОД ПРИЗРЕНА

Сажетак

Рад се бави истраживањем манастира као посебних “места” који су носиоци културе од средњег века – од када је овај вид верске заједнице установљен - до данашњег дана. Снажно су уграђени у идентитет једног народа тако да имају све атрибуте материјалног и нематеријалног наслеђа. Овај рад истражује однос који манастири имају као тачке окупљања, очување културе, обичаја и традиције што доприноси да се унапреди знање о начину живота у прошлим вековима. Студија случаја, којом се истражује улога манастира у колективној меморији и у његовању српског културног наслеђа, односи се на Манастир Светих Арханђела код Призрена који је био важан стуб српске средњовековне културе.

Кључне ријечи: културно наслеђе, култура памћења, (не)материјалне вредности, манастири, Призрен

1. INTRODUCTION

Understanding of biological nature of remembrance and research of mental processes started in the second half of 20th century with a revolutionary achievements of a psychiatrist Eric R. Kandel, which brought new insights into the understanding of human mind and a long-term memory. The past decade has witnessed a development of research of “culture of memory” as a tool for reviving history and its roots can be found in philosophy and psychology. Other disciplines such as history, anthropology and geography accept and build this phrase. Culture of memory is a phrase and it implies a collective memory of hard, dark periods of wars and traumatic experiences, victories or political turmoil. This phrase is more and more used in terms of tangible and intangible heritage as a connection with special past events and experiences. The phrase collective memory was introduced by a sociologist Maurice Halbwachs [1] who recognizes the phenomenon as a collective experience. Identity and remembrance were an object of research of a French historian Pierre Nora [2] who marks the concept of place of memory through those artifacts in which the collective memory is generated and consumed. Both theoreticians believe that certain activities can be found in the same place in spite of contemporary development since they can be understood only through collective memory. Tangible remains, street names, inscriptions, small islands from the past remain for a long time because losing them would be losing tradition, which gives them uniqueness and reason for existence [1]. Halbwachs concludes that there is not only personal but also collective memory that every group experiences in their own manner. The author believes that holy places affirm collectivity, ensure safety, they do not change over time and do not lose their character. The author Dacia Viejo-Rose [3] considers this phrase and improvement of understanding of remembrance and cultural heritage. The approach towards cultural heritage has evolved in the last decades. Remembrance can be defined as a retelling of an experienced event, something intangible, but it is done in space and time [4]. In broader meaning, remembrance as a social construction includes heritage and identity. Phrases that explore a relationship between remembrance and heritage include new words borrowed from other disciplines. In human sciences a manifestation of remembrance caused new phrases that relate to heritage [3]. The author Viejo-Rose states metaphors used for the relationship heritage-remembrance: memory trigger, memory container/storage, memory communicator, spatial marker of memory, anchor for memory, collection, or cache of memories, site of memory. Contemporary researches point out that the collective memory is an essential tool for continuity and heritage preservation [1][5]. Collective memory is a set of historical narratives, beliefs and customs shared by a social group, such as a community, culture or nation, over generations.

The paper explores the importance that the Monastery of the Holy Archangels has today as a social and cultural phenomenon, which serves as a spiritual and tourist center. The paper particularly examines the concept of the “collective memory” as a tool for analyzing the cultural heritage of this Monastery and its significance for a community and local identity. The aim of the paper is to examine the monastery as heritage through tangible and intangible dimension.

1.1. A NOTION OF MEMORY AND HERITAGE

For cultural and historical places it can be said that they are transformed from physical into social place combining topographical characteristics with the collective memory. The sole definition of “collective memory” includes tangible and intangible values as a tool of social and political culture to remember or forget the past and to construct future [6]. Medieval monasteries represent one of the most important elements in connecting a contemporary Serbian identity with the famous medieval past. One can conclude that monasteries are treasuries of experience and tangible traces of remembrance. International declarations on authenticity of heritage emphasize the need for its preservation in all its forms and historical periods. The Nara Document points out that responsibility for heritage and its management, first of all, belongs to a cultural community that created it [7]. The Warsaw Declaration states that documenting heritage through remembrance as an irreplaceable manner of transmitting tradition and historical awareness is an important component in the identity processes [8]. Medieval monasteries were isolated self-sustainable communities surrounded by natural resources that they used for living and production. These communities were very wealthy and powerful since they had large areas of land that they received as a gift. In addition to their religious role, they were very important for medical treatment, education and nurturing culture.

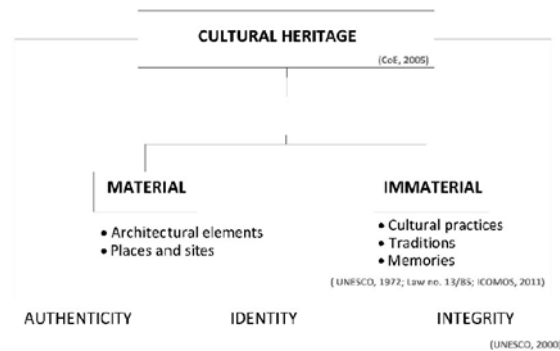

Figure 1. Conceptual diagram on the relationship between authenticity identity and integrity of the Cultural Heritage [9]

It is significant to state that for intangible heritage participation of community that for generations transfers and ensures its continuity is of a great importance. Function also contributes to authenticity and continuity. In order to ensure preservation of tangible and intangible, one must approach cultural heritage from a contemporary angle. All historical places, besides their practical function, possess a social content as well, which is not tangible and can be presented through symbols. Many medieval monasteries received a status of world heritage sites by UNESCO due to valuable architecture and manner of life as a civilization model (Monnet explains that “a symbol is a concrete reality (building, statue, etc.) that transmits something intangible (idea, value, emotion, etc.), in line with that a place of power is by a definition a symbolic place [10]. The author emphasizes that a significant part of power of public authorities and institutions was used for the development of symbolic spaces and they represent a relationship between space, power and identity. Nowadays monasteries represent a strong symbolic places that trigger cultural memory. Many authors believe that places of memory as intangible values should represent a symbol of universality through inclusive approach. Otherwise, some values will be highlighted while others could be excluded or ignored by other group. The author Yadin Dudai, who dealt with culture of remembrance of Jews, believed that “Collective memory“ is a set of historical narratives, beliefs and customs shared by a social group, such as a community, culture or nation, over generations [11]. It can be concluded that many generations preserved their culture through oral tradition long before written record was introduced. Collective memory, as the past that cannot be personally experienced anymore while contemporary individuals remember it, is considered as “historical memory” [12].

2. METHODOLOGY

Methodologically, the paper can be divided into two phases. The first phase includes collection and processing of data, while in the second phase those data were analyzed and valorized based on which conclusions were brought. This phase also includes a list of literature relevant to cultural memory as intangible heritage and identity. A case study is the Monastery of the Holy Archangels in Prizren. Data on tangible heritage as well as a process of reconstruction of the Monastery were received from the sources and publications on archeological research. The process of reconstruction was obtained from the publications issued by the Serbian Orthodox Church and initiatives to restore a monk’s life in the Monastery. Field data as well as testimonies of locals, monks and visitors about damage and reconstruction were very important for the research.

3. THE IMPORTANCE OF INTANGIBLE HERITAGE IN CONTEXT OF RECONSTRUCTION OF TANGIBLE HERITAGE

In a globalized world, usage of “cultural memory” as a tool to protect cultural heritage is a challenge. A concept and understanding of heritage has evolved, which brought changes in the approach to tangible remains from the past. Forms of intangible heritage result from all cultural groups [13]. This heritage is important since it is a part of life and culture of a community and it transfers from one person to another during generations and it can strengthen a feeling of identity and nurturing culture. The Burra Charter states that a place and intangible heritage can include symbolic or spiritual connection with the place even if they are far away from the place. Oral tradition shares collective memory while in practice one often neglects intangible heritage in comparison to tangible. This type of culture can reveal characteristics that are specific and important for the place and

specific community. Montgomery's theory (John Montgomery) is used for connecting the collective memory and feelings for the place, which can be crucial for the place revival. He combines three essential elements: physical space, sensory perception and activities [14]. The place can obtain its meaning by an individual, it can be created from a manner in which it is used, but it can be a reason due to unique characteristics that the place possesses. The best example of nurturing the culture of memory is found in Jews who has passed oral tradition for over three thousand years. It is continuity and ability to keep and reconstruct events from recent or distant past that is manifested in Jews [11]. The practice showed that when a community abides by its customs and traditions, memory can remain even without geographical and socio-political conditions. Memory helps with defining short-term and medium-term tasks for certain activities. A positive example is a reconstruction of the Đurđevi Stupovi Monastery near Novi Pazar, which was built by župan (clan leader) Stefan Nemanja, a father of an important Nemanjić dynasty. The importance of the Monastery and its intangible value as well as respect payed to the Nemanjić dynasty in the collective memory led to involvement of the whole nation in the Monastery's reconstruction. There is an excellent example of the collective memory during rehabilitation of industrial suburbs in Lisbon [5]. Many conventions and charters give recommendations how to adjust the place to the contemporary needs without losing its identity. A function should be a part of its authenticity and it should ensure its continuity and preservation of tangible and intangible heritage. One of those examples is the Spanish royal monastery and palace El Escorial (Spanish: El Real Monasterio de El Escorial). The function of this site is a residence of Spanish kings that includes a monastery, church, royal palace, museum and school. It has been a monastery and a royal palace at the same time, and up to now it has not changed its secular and religious role.

4. THE MONASTERY OF THE HOLY ARCHANGELS IN PRIZREN

In medieval Serbia, a Church was one of the most important carrier of a public function, and monasteries were centers of religious and social life that reflected power of patrons, tangible and spiritual values of that time. This shows the meaning and importance of monasteries as symbols with expressive forms based on systems of values and which express some higher goals. The Monastery of the Holy Archangels in Prizren was established as a legacy of Stefan Uroš IV Dušan (known as Dušan Silni) from the Nemanjić dynasty. It is placed at the left bank of the river Bistrica and it is 3 km away from Prizren, which was a developed medieval city at that time. It was built in the Danube gorge of Prizren's Bistrica that connects Sredska District and Prizren ravine. It is placed at the bottom of the mountain Šar – in the Middle Ages it was called Gora Krsna or Krštena-Krstac where hermit caves existed [15]. The Monastery complex, in the area of 6.5 ha, was built at the left bank of the river Bistrica where the river makes a bend in a small triangle island under the fortification of Višegrad.



Figure 2. Position of the monastery

4.1. TANGIBLE HERITAGE OF THE MONASTERY OF THE HOLY ARCHANGELS

Višegrad or Up Town (Prizrenac) was a medieval Byzantine and Serbian castle, a fortification that kept Prizren ravine from enemies' attack [16]. Within the fortification of Višegrad there was a church dedicated to St. Nikolaj. At the bottom of the Monastery complex there was an early Christian church dedicated to the Holy Archangels Mihailo and Gavriilo, which was written in the Dušan's charter whose remains were found in the floor of the main church [16]. According to assumptions of an archeologist Grujić, the early Christian church was the oldest and the most respected one in the area, which was a reason why the emperor Dušan decided to build its legacy and crypt. It is possible that the original church was important for the people, which was crucial in order to make a decision to build an emperor Lavra because the site occupied small area in the ravine. Definition in the dictionary English "In Orthodox Christianity and certain other Eastern Christian communities, Lavra or Laura is type of monastery consisting of a cluster of cells or caves for hermits, with a church and sometimes a refectory at the center; the term in Greek initially meant a narrow lane or an alley in a city." (definitions.net). The landscape of the ravine with the strong mountain river Prizren's Bistrica contributes to greater recognition of the Monastery and sensory perception of the place. Hence, it can be concluded that the site was not chosen accidentally. Preparation for construction started in 1343 and the construction was done from 1348 to 1352 when rich ornaments, decorations, iconography and mosaic floors were finished. The Monastery was divided into "Down Town" where the Monastery complex was places, and "Up Town", castle Višegrad, and this wholeness was called "Dušan's Town" by the people. These parts were connected by walls in unique defense "pillar" or "tower" [15].

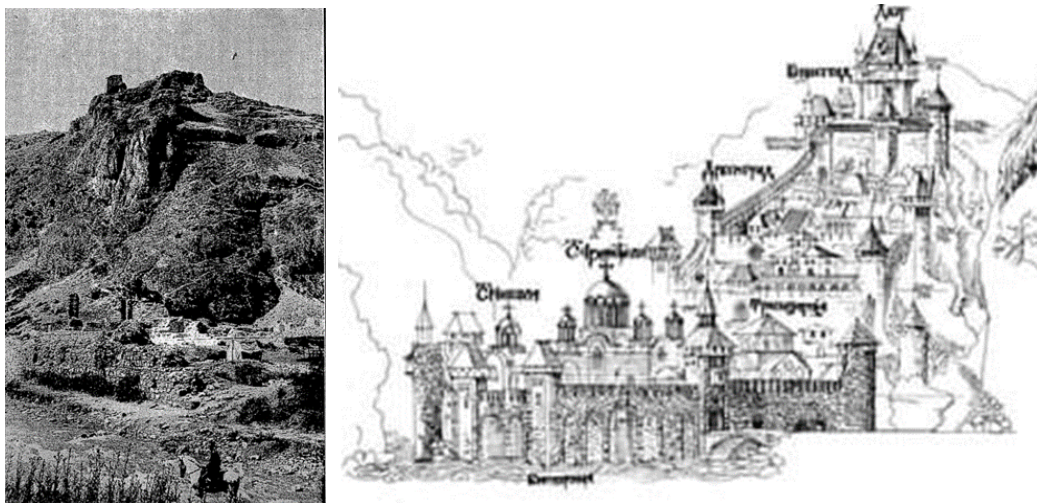

Figure 3. a) Višegrad, at the bottom there are remains of the Monastery of the Holy Archangels after archeological excavation in 1927 – a photograph by prof. Radoslav Grujić;

b) Reconstruction project Monastery of the Holy Archangels prof. Predrag Ristić

According to the research done by Radoslav Grujić, the Monastery complex "Down Town" consisted of: the main church dedicated to the Holy Archangels, smaller church of St. Nikola (parecclesion, Greek: Παρεκκλήσις), dining room, hospital, monks' cells, lodge for rulers, clerk office and other accompanying rooms. Παρεκκλήσις Parecclesion is a smaller church (gr. παρα next to and ἐκκλησία church). In orthodox monasteries there were smaller churches where ceremonies were held like in the main churches but based on the needs when the winter was cold. In the West, these churches are called chapels [17]. Around the Monastery there were walls by the river Bistrica. The entrance to the Monastery led over the stone bridge over the river Bistrica from the North-West side where the main gate was placed.



Figure 4. a) *The Monastery complex after excavation in 1927 [16]*

b) *The Monastery in the middle of the last century [19]*

In the middle of the complex there is the main church dedicated to the Holy Archangels, which is a five-domed building with a basis in the shape of an inscribed cross, with narrowed side naves and a three-part altar apse. According to the reconstruction by Slobodan Nenadović, a twelve-part dome is placed on four arches that held four pillars, and there were also four smaller side domes [15].

In the North nave, there was an emperor's crypt. The façade was made of white and red marble divided by cornice into three zones. This object was well-known for its floor made of white and blue stone tiles, and the church nave was made of stone reliefs where in the fluting there were mosaic tiles which depicted animals (lions, fish, birds) [15]. The smaller church dedicated to St. Nikola was built in the Southern part as a one-nave building with a dome. In the South-West part, there was a dining room with the apse on the Southern side. With its shape of an inscribed cross and new elements, it represents a novelty in medieval monasteries in the Balkans (<https://www.zaduzbine-nemanjica.rs/Sveti-Arhandjeli/index.htm>). Inside the walls, there were lodges, hospital, library and other rooms. The Monastery was very wealthy since it had 93 villages (some of them were in Albania, Montenegro and North Macedonia), forests and pastures. Construction of the Monastery happened at the height of economic and political power of the Serbian medieval country, which contributed to creating a rich architectural building. In support of that, there are written scripts about the Monastery's beauty, its rich floors, stone, stone plastic and sculptures as a valuable architectural and artistic work.

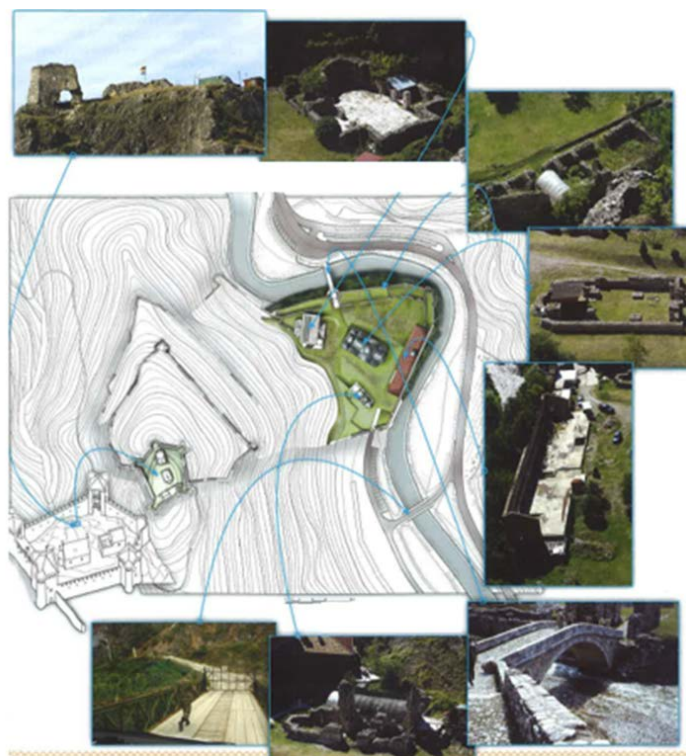

Figure 5. *Monastery complex “Up town” and “Down town” map drawn by mr Nebojsa Gadžić (mr Hebojua Γαγυή, [15])*

At Easter 1346 Stefan Uroš IV Dušan became the first crowned emperor of the Serbian country which raised the Monastery's status, which became the emperor's lavra, and it is one of the most significant and beautiful legacies of the medieval Serbia.

In the original form, the Monastery was preserved for something more than one century because on 9th June 1455 Prizren came under the rule of Turkish authority. The Monastery was robbed and damaged on multiple occasions, however, the monk's life was not interrupted until 17th century when the Monastery was destroyed and its stone and elements were used for building the Sinan Pasha Mosque at the centre of Prizren [18].

Due to the Monastery's location at the bank of the river Bistrica, the place that was abandoned for centuries was covered by river sediment. Famous history and the importance of medieval Prizren as well as the legacy of the emperor Dušan caused interest and pride of Prizren's Serbs. Jovanović writes about the first visit of pupils from Prizren's Gymnasium to an archeological location of the Monastery of the Holy Archangels during 1923. [18]. The pupils and professors of Prizren's Gymnasium started amateur excavation in the Monastery's complex. An official excavation of the Monastery started in 1927 led by prof. Radoslav Grujić when the Monastery's remains were discovered after a few centuries. The research was continued in 1970s of 20th century and 1990s when a decision on the Monastery's reconstruction was made. The reconstruction of the Monastery's lodge started in 1995 with a construction of a lodge and a chapel dedicated to St Nikolaj Žički. Life in the Monastery started in 1998 but due to the war in 1999 Serbs left from Prizren and surrounding places. The Monastery continued its life until 17th March 2004 when the lodge was completely burnt during the March riot. The reconstruction of a smaller lodge was finished on 26th July 2005 when the Monastery celebrated its "slava" and the monk's life was restored. The reconstruction of a smaller church of St. Nikola started, which was temporarily suspended by the authorities from Priština. The Monastery is under the protection of the Republic of Serbia as the cultural heritage of great importance. A new big lodge was reconstructed in 2014 when many believers started visiting the Monastery and cultural events were organized.

4.2. THE MONASTERY OF THE HOLY ARCHANGELS AS A PLACE OF GATHERING – CULTURE OF REMEMBRANCE – INTANGIBLE HERITAGE

In addition to its main function, the Monastery of the Holy Archangels has a complex social content which is used in certain historic circumstances. As a symbolic place it carries something more than tangible value since, at the same time, it is a symbol of culture, gathering and remembering which increases people's emotions and feelings of belonging. Symbolic places are often used for a point of gathering and social interaction. "Analysis of a place's symbolism is semiology of spatial forms towards interpretation network of culturally grounded categories (authority, identity, centrality, legitimacy, monument, public, private, etc.) [10]. The location of the Monastery of the Holy Archangels was visited by the Christians because they knew that an early Christian church had been there. The archeologist R. Grujić had proofs for this. The Monastery had a hospital where people from the surrounding places and villages that belonged to the Monastery came for treatment. From the day of establishment, its role was more than a closed monastery life and it was always a part of public life. According to the church's scripts, after the emperor Dušan's death, there were three important events in the Monastery. The great state's parliament was held in 1356 which discussed further destiny of the Serbian country after the death of the last Nemanjić. The second important event was the state's parliament when the duke Lazar was proclaimed the Serbian ruler. The third important event took place in 1375 when solemn reconciliation happened between the Serbian and Constantinople's church [15]. The plan of the reconstruction of the Monastery in 1998 was for it to become a headquarter of Eparchy of Raška and Prizren and to develop as a centre of publishing [19]. These plans were not fulfilled due to the war in 1999 which resulted in exodus of the Serbian people and due to the March riot in 2004. After the reconstruction in 2005, and especially after the reconstruction of the lodge in 2014, a cultural life was brought back into the Monastery and it became a centre of certain important events. During the recent years certain cultural manifestations have been held (children's folklore festival "Towards Vidovdan", calligraphy summer school, Prizren's spiritual summer school, art colony, etc.). The aim of all these manifestations is to preserve intangible heritage, traditions and customs.



Figure 6. *The Monastery today*

5. THE IMPORTANCE OF THE MONASTERY'S RECONSTRUCTION

The Monastery complex was destroyed and reconstructed; however, the characteristics of a place identity, such as its surrounding, remained intact. The architectural identity of the Monastery is present in its tangible parts in the original constructive elements which remained preserved in the parts of floor and remains of decorations. The reconstructed parts of the Monastery are a part of identity as well as the original parts since they coexist in a historic place. The richest symbolism for the Serbian people is found in monasteries as historic and cultural centres where one can find continuous investments from the Middle Ages through construction and later reconstruction. The Monastery's reconstruction is the process of revitalizing memory because that way tangible objects, preserved in stories and written scripts, become visible [20]. Demolition of the Monastery represents tangible deletion of history but it has not been deleted from memory.

For the Serbian community in Prizren, the archeological location always triggered memories of past and famous history through sensory perception. Besides other towns in Kosovo and Metohija, people were especially proud of the status "the emperor's town". The official capital of the emperor Dušan was Skopje, but Prizren was occasionally a capital of the Serbian kings (Stefan, Dragutin, Milutin) and emperors (Dušan Silni and Uroš V Nežak) from the Nemanjić dynasty. The period of the emperor Dušan was especially significant for the Serbian community in Prizren because they consider it as his capital when the Serbian country was the strongest in terms of economy and military. Prizren, placed at the crossroads of important trade roads, ensured good connections with Dubrovnik and Constantinople. Due to its importance, it was called "little Constantinople" in folk's poems and stories. The local people kept stories that Prizren had as many Orthodox churches as there are days in a year. Those stories were backed up by the facts that Prizren eparchy was mentioned in 11th century in the Byzantine period under the competences of the Archbishopric of Ohrid. Negative effect on the Serbian cultural heritage and collective memory was created by forced migration of the Serbian people as well as fights and destruction on their heritage at the end of 20th and at the beginning of 21st century. Different structure of population and religious differences had a negative impact on collective memory. Intangible values, pride and "collective memory" were initiators for the reconstruction of tangible component in the Monastery known as "Dušan's town". This way, "culture of memory" served as the main pattern for tangible reconstruction.

6. CONCLUSIONS

The paper showed a complexity of mutual relationships between tangible heritage and culture of memory. On the one side, culture of memory contributes to collective need to reconstruct and revive tangible heritage. In case of destorying tangible heritage, memory helps a community to intervene and reconstruct its significant objects. Not all objects are preserved in the memory since they do not have the same importance for people. The architectural heritage that is preserved in memory can be rebuilt based on the remains and available data. Intangible heritage, through historic collective memory, reverts a society to referent points in history.

From the other side, reconstruction contributes to reviving the content, activities that create identity which in its roots has culture, tradition, and customs.

The role of the Monastery of the Holy Archangels is not the same as it used to be when it was established, but it is an important point of intertwining of history, culture and important events. It was established at the height of power of the Serbian medieval country, by the Serbian crowned emperor who enacted the most important law for the country's arrangement with the regulations.

All of these historic data helped in preserving its legacy and crypt in the collective memory of people because they triggered pride. The thing that was left of the Monastery's complex were the ruins covered by the land hidden for over three centuries; however the memory of "Dušan's town" placed at the location has never been erased. The collective memory helped in finding the ruins because the great will of the Prizren people contributed to organized research of the location. Finding the ruins helped in reconstructing the visual aspect of the former complex. Nowadays, the Monastery and the cells that were rebuilt are much more modest than the previous design but they are still of a great importance for the referent point for the Serbian community in Prizren. A number of visitors and many cultural events show that the Monastery is a place of gathering, education and the tradition and customs guardian. All places of cultural heritage have a potential to become a place of memory, but only specific cultural heritage has a potential for continuous revival. Sometimes, collective memory as intangible heritage has a greater importance than physical proof at the location. In order to contribute to a wider engagement it is necessary to ensure activities of the Serbian autochthonous local community, which is placed around the Monastery, regarding preserving and managing the location since it ensures its perspective as a referent point in future.

The final reconstruction of the Monastery's life and cooperation with other institutions of culture will enable all preconditions for preservation of tradition in terms of calligraphy, folk dance, knight games, music, making of Prizren's traditional clothes, filigree, etc. Cultural creation entails unity of tangible and intangible heritage, using memory and heritage in order to imagine something new and achievable.

LITERATURE

- [1] M. Halbwachs, *On collective memory*. Chicago: The University of Chicago Press, 1992, 254.
- [2] P. Nora, "Between Memory and History: Les Lieux de Mémoire.", *Representations*, Special Issue: Memory and Counter-Memory vol. 26. pp. 7-24, 1989.
- [3] D.Viejo-Rose. (2015, Decemer). "Cultural heritage and memory: untangling the ties that bind." *Culture and History Digital Journal*. [On-line]. 4 [2], pp.1-13. Available: DOI: 10.3989/chdj.2015.018 [08.02.2022]
- [4] J. Sather-Wagstaff, "Heritage and memory," *The Palgrave Handbook of Contemporary Heritage Research*. (Ed. Waterton, E., Watson, S.), pp.191-204, 2015. Available: <https://doi.org/10.1057/9781137293565>
- [5] M. Reis e Silva, "Space and memory: written sources and oral history when planning urban renewal," in *ImaTTe. Intangibility Matters: International Conference on the values of tangible heritage* (Ed. Menezes, M., Rodrigues Costa, D., Delgado Rodrigues, J.) Lisbon: LNEC. 29-30 May 2017, pp.279-288. Available: http://www.iperionch.eu/wp-content/uploads/2019/04/IMaTTe2017_Proceedings.pdf. [24.01.2022]
- [6] Z. Ekim, E. E. Güney, M. Vatan, (2017, August). "Documenting the intangible and the use of „collective memory“ as a tool for risk mitigation," *The International Archives of the Photogrammetry, Remote Sensing and Spatial Information Sciences*. Volume XLII-2/W5, 26th International CIPA Symposium 2017, 28 August–01 September 2017, Ottawa, Canada Available: DOI: 10.5194/isprs-archives-XLII-2-W5-201-2017 [08.02.2022]
- [7] ICOMOS, *The Nara document on authenticity*, Nara, Japan, 1994.
- [8] UNESCO, *Warsaw Declaration: 'Culture – Memory – Identities'*, Warsaw, Poland, 2011.
- [9] P. Faustion Salomé, S. Alexio, A. Conde Fialho. "Identity and architectural values of the monastery of SÃO Bento de CÁSTRIS in the period 1957-2005." in *ImaTTe. Intangibility Matters: International Conference on the values of tangible heritage* (Ed. Menezes, M., Rodrigues Costa, D., Delgado Rodrigues, J.) Lisbon: LNEC. 29-30 May 2017. pp.85-96. Available: http://www.iperionch.eu/wp-content/uploads/2019/04/IMaTTe2017_Proceedings.pdf. [24.01.2022]
- [10] J. Monnet. (2011, Octobre). "The symbolism of place: a geography of relationships between space, power and identity." *Cybergeo: European Journal of Geography. Politique, Culture, Représentations*. [Enligne], Article 562. Available: DOI : <https://doi.org/10.4000/cybergeo.24747> [24.01.2022].
- [11] Y. Dudai. (2020). "Persistence of collective memory over 3000 years: The case of ancient vs. Modern Israel." In *National Memory in a Time of Populism*. (eds. H.L. Roediger and J.V. Wertsch). New York: Oxford University Press. Available: https://www.weizmann.ac.il/brain-sciences/labs/dudai/sites/neurobiology.labs.Dudai/files/uploads/Dudai_Cultural_Memory_In_Press_.pdf. [21.02.2022]

- [12] M. Halbwachs, *La mémoire collective*. Paris: Editions Albin Michel, 1950, 304.
- [13] The Australia ICOMOS, *The Burra Charter, The Australia ICOMOS Charter for places of cultural Significance*. Australia ICOMOS Incorporated International Council on Monuments and Sites, Australia, 2013.
- [14] J. Montgomery, "Making a City: Urbanity, Vitality and Urban Design," *Journal of Urban Design*, Vol.3 [1], pp. 93-116, 1998.
- [15] Група аутора. Манастир Светих Арханђели. Српска културна и духовна баштина. Немањинки манастири. Цетиње-Београд: Митрополија црногорско-приморска. ИИУ Светигора. 2011. p.63.
- [16] R.Grujić, "Откопаванје Светих Арханђела код Призрена (Preliminarni izveštaj)." *Glasnik Skopskog naučnog društva, knjiga III*, Skoplje, 1928. str. 239-274
- [17] <https://sr.wikipedia.org/sr/Параклесион>, Available: [10.02.2022]
- [18] М. Јовановић. "Призренски гимназијалци и археолошка ископавања манастира Свети Арханђели код Призрена 1923.године." *Косовско -метохијски зборник*, бр.7. Београд: Српска академја наука, стр. 121-130, 2017.
- [19] <http://www.kosovo.net/sarhangel.html> Available: [10.02.2022]
- [20] H.Marçal. "Conserving places of memories: on social significance and justice. Intagibility Matters" in *ImaTTe. Intangibility Matters: International Conference on the values of tangible heritage* (Ed. Menezes,M., Rodrigues Costa,D., Delgado Rodrigues,J.) Lisbon:LNEC. 29-30 May 2017, pp.271-279. Available: http://www.iperionch.eu/wp-content/uploads/2019/04/IMaTTe_2017_Proceedings.pdf
- [21] S.Aulet, L.Mundet, D.Vidal. (2017, janury). „Monasteries and tourism: interpreting sacred landscape through gastronomy“, *Brasilian journal of tourism São Paulo*. 11(1), pp. 175-196. <http://dx.doi.org/10.7784/rbtur.v11i1> [29.12.2020]
- [22] UNESCO. "Convention for the Safeguarding of the Intangible Cultural Heritage". (2003). General Conference Paris. 17 October 2003.
- [23] M. Jewdokimow, B. Markowska. (2013,Juny). "Study of the heritage of dissolved monasteries in local collective memories." *Hereditas Monasteriorum*.Vol.2.pp-19-34 Available: <http://hm.uni.wroc.pl/wp-content/uploads/2013/09/HM-2-2013.pdf> [29.12.2021]
- [24] E.R.Kandel, *In search of memotry: The Emergence of a New Science of Mind*, W.W. Norton & Company, New York, 2007, p.528.
- [25] J. Montgomery, "Making a City: Urbanity, Vitality and Urban Design." *Journal of Urban Design*, Vol. 3 (1), 93-116. Available: <http://dx.doi.org/10.1080/13574809808724418> [28.01.2022].
- [26] N.Moore, Yvonne W. (eds.) *Heritage, Memory and, the Politics of identity*, England: Ashgate Publishing Limited, 2007, p. 149
- [27] UNESCO, *Warsaw recommendation on recovery and reconstruction of cultural heritage*, World heritage centre, Ministry of culture and National Heritage of the Republic of Poland, Warsaw, Poland, 2018.
- [28] R.Willson, "History, Memory and Heritage," *International Journal of Heritage Studies*. Vol.15. No 4. Routledge. pp.374-378, 2009.

46

Review paper I Прегледни научни рад
DOI 10.7251/STP2215476N
ISSN 2566-4484



Zvonimir Nevistić, University of Zagreb, znevistic@geof.hr

Željko Bačić, University of Zagreb, zbacic@geof.hr

USER NEEDS ASSESSMENT FOR THE ESTABLISHMENT OF SPATIAL DATA INFRASTRUCTURE OF CELESTIAL BODIES

Abstract

Large amounts of data are collected on space bodies, and all data is available to all users free of charge through various archives and portals. When searching for data, especially non-space scientists, often have problems because the archives are tailored to meet only space experts needs. Prior knowledge about missions is necessary to search data and use archives. Large amounts of data, and the interest of the public impose the need to develop Spatial Data Infrastructure of Celestial Bodies to enable efficient use and exchange of data. In this paper user needs assessment, in the form of global survey, for the purpose of establishing SDICB was conducted. The results will serve as a basis for establishing guidelines for the implantation of the SDICB concept.

Keywords: Archives, Space Data, SDICB, User Needs Assessment

ПРОЦЈЕНА ПОТРЕБА КОРИСНИКА ЗА УСПОСТАВУ ИНФРАСТРУКТУРЕ ПРОСТОРНИХ ПОДАТАКА НЕБЕСКИХ ТИЈЕЛА

Сажетак

У данашње вријеме свим корисницима бесплатно су доступне велике количине података о свемирским тијелима путем разних архива и портала. Приликом претраживања тих скупова података, корисници изван домене свемирских истраживања често наилазе на проблеме јер су архиве прилагођени потребама свемирских стручњака. За претраживање података потребно је претходно знање о мисијама. Велике количине података као и повећани интерес јавности за податке свемирских истраживања намећу потребу развоја инфраструктуре просторних података небеских тијела (ИППНТ) како би се омогућило учинковито кориштење и размјена података. У овом раду проведена је процјена потреба корисника, у облику глобалне анкете, која ће послужити као основа за доношење смјерница приликом успоставе ИППНТ-а.

Кључне ријечи: Архиве, Свемирски подаци, ИППНТ, Процјена потреба корисника

1. INTRODUCTION

The digital age we live in today has made it possible to have large amounts of information easily accessible through various web services. With the development of technology, a number of tools have been developed to support and distribute spatial information, which is often one of the most important elements in decision-making in many disciplines. Although spatial information is easily available today, there is often the problem of finding adequate and consistent information for different needs, and the large amount of data that has appeared over the past few years does not facilitate their search [1]. This fact has triggered the development of the Spatial Data Infrastructure (SDI) concept, which solves the problem of finding spatial data and reducing their redundancy [2] and enables better data management, which can bring economic and environmental benefits. The SDI concept connects existing spatial data into a single network, and to be successfully implemented, it is necessary to harmonize existing data sets and standardize their quality [3]. The implementation of this concept provides a basis for searching spatial data, their assessment and different application at all levels of society and facilitates integration with other data sets, which opens new innovative business opportunities, significant resource savings, promotes sustainable development, better environmental management, and social stability [4, 5].

As space exploration has intensified over the past decade and numerous scientific studies of planets and other celestial bodies have been launched, the interest of a wide range of users in this type of data has increased. Space research data are of particular interest and importance because their interpretation provides a better understanding of the Earth and its dynamics and provides answers to current and important questions, such as the impact of global warming [6], provides a better understanding of the solar system and is used to mitigate dangers of life on Earth and contribute to the development of science in general in terms of new technologies, engineering, and mathematics. Data collected by numerous space missions of different agencies are given to users for use through various space data portals and archives. Access to this data is free for all users. As the archived data are not suitable for direct use, the data is accompanied by metadata to facilitate their use for a wide range of users [7]. The primary purpose of these archives was the long-term storage of data for space scientists and their research, so the archives are tailored to their needs. With the increase in the number of multidisciplinary missions, the number of scientists who want to access this data has also increased. At the same time, the interest of scientists from other fields as well as the public has also increased. For such groups of users, searching the archives is a great challenge because prior knowledge about the missions that collected the data is needed to successfully obtain the data of interest. The biggest problems of existing archives are also the visibility, accessibility, understanding and interpretation of data as well as users' expectations for interactive services that will help them research, discover, filter, and visualize data before downloading [8, 9].

Because of the mentioned increase in the amount and diversity of data and public interest in the use of data, there is a need for a Spatial Data Infrastructure of Celestial Bodies (SDICB) as an extended concept of traditional terrestrial SDI, which should address the challenges of collecting, managing, finding, and using space research data. As one of the first steps for the establishment and implementation of this concept, it is necessary, among other things, to investigate what data is collected and to what extent, how data is currently distributed and analyze the needs and requirements of users. In this paper, a User Needs Assessment (UNA) was conducted for the purpose of establishing such an infrastructure, and the results of the assessment, in the form of user needs and requirements, will serve as a basis for establishing guidelines for IPPNT concept implementation which will improve the availability of space research data.

2. DATA ARCHIVES OF SPACE RESEARCH

Space spatial data are all data with a spatial component collected by direct or remote observations on space bodies in the solar system. The first space body for which data was collected is the Moon. Mapping of the Moon began in early 1600s with the invention of the telescope [10]. Until the 1900s, when the first space missions were launched, telescopes, placed on the Earth's surface, were used to observe space bodies. In 1964, the American spacecraft Ranger VII collected over 4,000 telescopic images of the Moon. These images were used to create the first catalog of space data collected by remote sensing techniques. Since then, many missions, primarily from the United States but also from other countries, have been involved in mapping the Earth's Moon, Mars and other planets and their satellites, as well as observing other, smaller space bodies. What has been most explored on space bodies from the beginning until today are the geo-logical features.

The biggest difference in the use of space spatial data from those collected on Earth is their shape and size. International Astronomical Union (IAU) defined, for almost all major bodies in our solar system, geodetic parameters, which allows mapping of their surface as well as new opportunities for research of these bodies. The definition of coordinate systems on space bodies forms the basis (standards) for all other interoperable initiatives in space science, which relate to the collected spatial data.

Although the collection of data (especially those with a spatial component) in the space community has progressed rapidly, there are still no adequate ways to store this data and distribute it to users. One of the main problems is the fact that the space scientific community is extremely decentralized, and each organization has its own archives and data sources, but also the standards and formats they use. The main goal is to develop standards that would enable the interoperability of these data between different communities and that would create the foundations for the establishment of a SDICB. Space data is available to everyone, in its full extent, but the big problem is finding and interpreting it. Therefore, it is necessary to create spatial data that will satisfy all users (development of policies, standards, etc.) and that will be easy to find, share and interpret (metadata).

Data in the planetary community mostly come from the instruments of certain missions, and there are several different portals for finding those data. The largest archive of space data, which includes all data collected by missions under the jurisdiction of NASA, and other space organizations, is the Planetary Data System (PDS). PDS consists of several nodes (access points), each of which has a separate interface, which makes finding this data not easy. The purpose of this archive is to make the data publicly available to everyone, scientists, engineers, and other users. However, the problem arises in the fact that certain data of interest to users is difficult to find and there is no adequate metadata for its interpretation. In addition to the PDS, there are other access points such as ESA's Planetary Science Archive (PSA), but also many other mission portals where mission managers distribute data to users for use.

All of this points to many shortcomings in accessing, finding, and retrieving space data, especially for users outside space communities and the public. Space research is interdisciplinary research and not only space but also scientists of other professions are interested in it. Space exploration can give us a better understanding of our planet, so the data collected by space missions should be easily, efficiently, and understandably available to everyone. The analysis of archives and related services for finding space data from the perspective of non-space sciences leads to numerous shortcomings in the methods of their storage and distribution. Some of these shortcomings are: dispersion of data due to the large number of access points, incomprehensibility of data caused by inadequate metadata, incomprehensible data formats that cannot be used in standard processing tools, the need for some prior knowledge to successfully find data, poor search and data filtering options that gives too many of the same or similar results, inability to search the data on the map and visualize the data before down-loading, and poor supporting documentation and instructions for using the archive. All the above indicates that the archives are outdated and that it takes too much effort and time to search for the data. Archives and related services are not designed to be user centric. It is necessary to create approaches that would be more user-friendly and that would simplify data retrieval. Given the growth and large investments in space missions and technologies, these problems must be resolved as soon as possible, and one of the solutions to these problems is the establishment of a SDICB following the example of terrestrial SDI initiatives.

3. IMPROVING THE AVAILABILITY OF SPACE RESEARCH DATA

To improve the availability of space research data, a number of initiatives have been launched to make it easier for users to search and download data of interest. The motivation to support common, interoperable data formats and standards is not only to improve access to products but also to solve the problem of distributing increasing amounts of data. Within the space community, terabytes of data are available for planets, satellites, and other celestial objects [11]. For this reason, there is a need to adopt standardized formats and delivery methods to users.

Most of the space data collected by NASA, but also by other, non-US space missions, is stored in the PDS format / standard (PDS3/4) [12]. Most of the data is archived in the original (raw) form of the instrument which was used to collect the data. Unfortunately, the PDS format, although well documented with a focus on long-term availability in archives, is not widely recognized in spatial data mapping and analysis applications (such as GIS tools). Two formats that are recommended for use when collecting and archiving space mission data are GeoTIFF and GeoJPEG2000 [11]. Another format that is imposed and often used within the astronomical community and is also recommended for the space data is Geo-TIFS. These formats are compatible with PDS standards and are supported

by a large number of open-source software tools and catalogs. Although GeoTIFS format is widely used in astronomical observations, it is rarely used in the space community, but there are initiatives to spread FITS standards to support geospatial markings in space research. The use of this format could provide uninterrupted data exchange in the community and potentially homogenize data collection and visualization methods [13].

The U.S. Geological Survey's Center for Astrogeology (USGS ASC) is the main institution for software support of cartographic data processing for NASA's re-search missions and programs. ASC has developed Integrated Software for Imaging and Spectrometers (ISIS) which is a specialized tool for image processing and working with space data [14]. ISIS3 (third version of the software) is compatible with several different widely spread formats, but processing is only possible in a specialized custom image format. In 2006 and 2007, the PDS and ISIS3 format were added to the GDAL (Geospatial Data Abstraction Library) to improve interoperability with other applications and tools. By adding these formats to GDAL, conversion and direct use within numerous applications and software for GIS and spatial data processing is enabled.

In the domain of web service, the consortium that defines standards is Open Geo-spatial Consortium (OGC). OGC define standards such as WMS (Web Map Service), WMTS (Web Map Tiles Service), WFS (Web Feature Services) and others for web mapping and data visualization and retrieval. Several space missions support WMS / WFS standards. This allows users to search and visualize spatial databases projected on a map in JPEG or PNG format. The WMTS service is also used in some missions, but it is not as flexible as the previous two and cannot generate images at any scale, therefore, it is recommended to use WMS and WFS services when distributing space research data [11].

The IAU defines the specifications of reference systems used in the space community, and the use of which is recommended, to harmonize the use of spatial reference on all data. What IAU do not define are standards for digital mapping such as cartographic signs, attribute and symbol features, metadata, etc. It is recommended to use the digital cartographic standard for symbolization of USGS geological maps [15]. This will make easier to read and understand space maps. In addition to the reference systems, the IAU also publishes a journal of planetary nomenclature, whose wide application unifies the names used for geographical features on space bodies.

Many initiatives to improve the availability of space data have been launched through volunteer communities and various private organizations. One of these initiatives is MPASIT, which provides recommendations for the development of a comprehensive planetary spatial data infrastructure. Europlanet initiative aims to connect the European space community and project of geological mapping of Mars, Mercury and the Moon was also launched within it. The VESPA initiative deals with the availability and distribution of space data from various scientific domains. Several initiatives address the standardization of space data archiving such as PlanetServer, Open Planetary initiative provides an online framework to help collaborate between different institutions in planetary mapping, and CARTO initiative is focused on web solutions for spatial visualization and data analysis of space research data.

As already mentioned, one of the solutions to the problem of rapid increase in the amount of space research data is the establishment of an efficient spatial data infrastructure (SDI) – SDICB. The SDICB will allow standardized collection, management, and retrieval of spatial data from space exploration. The existing archives, given their objectives and method of implementation, currently do not meet the main principles of the SDI. SDI must serve the wider community whose members do not need to be spatial data experts and who do not understand the intricacies of storing, retrieving, and using spatial data. Archives are technology-oriented and need to focus on simplifying data access and improving data usability. The main reasons why SDICB is needed is that its establishment would keep all data in one place, will avoid duplication of data, harmonize the formats, and achieve their interoperability, simplify access and downloading. Using these datasets would reduce the number of difficult-to-understand data access tools and allow other users outside the space community to access and use the data [16, 17].

To establish such a user-oriented concept, it is necessary to conduct a user needs assessment which will analyze the requirements and needs of users who will use new ways of accessing space data in the future. By implementing such a concept, that would meet the needs of a wide range of users, the data would not remain unused i.e., the currently inefficient management of this valuable data set will be avoided. Similar as terrestrial SDI initiatives, SDICB should be a set of agreed standards, institutional cooperation agreements and policies to describe the framework within spatial data from space exploration will be collected and organized so that they are easily accessible and usable for a wide range of user.

4. USER NEEDS ASSESSMENT

The main goal of SDICB is to provide space research data to a large number of different user groups, regardless of their knowledge and skills about spatial or space data. Therefore, the development of such an initiative focuses on the needs of users to develop an effective and sustainable SDI. By focusing on user needs SDICB will reach its full potential in the context of spatial data sharing. Given the current non-existence of the concept, a user-based approach is applicable as this assessment must be considered at the very beginning of the establishment. The main feature of this approach is that user requirements need to be researched first and that they form the basis of SDI development. In this approach, users are a separate component in the development and implementation of the initiative [18]. Users require easy access to data, metadata, and services, and each request must be met for the satisfactory function of SDI. In this approach, the survey is the best tool for gathering information on user needs because it can be distributed to many addresses and gain insight into different user needs through open and closed questions. The disadvantages of this approach are the reduction of the ability to comment on specific needs and the possibility to not obtaining sufficient input data to conduct the analysis.

The chosen approach for user needs assessment in this research, as a tool for collecting input data, i.e., identifying user needs and requirements, which will later be used for conducting a guideline for the establishment of SDICB is a global survey.

4.1. CONDUCTED RESEARCH

For the purpose of the research, two global surveys created for two different user groups were sent. The first group of users consists of scientists and individuals who use space data and archives in their work (SD users). The second group of users are scientists, researchers, and students in the field of spatial data interest-ed in space data (GI users). Therefore, two separate global surveys were conduct-ed, each of the surveys was sent to a specific group of users, and the synthesis of the obtained results from both surveys will be used to create guidelines for establishing SDICB based on user needs. In compiling the surveys, efforts were made to consider the different theoretical views of such research. Each individual question is a separate input for final analysis, and the questions are grouped according to the definition of SDI, i.e., efforts were made to cover all relevant components necessary to obtain an adequate assessment of user needs.

The first survey, for SD users, consists of a total of 39 questions and was sent to a group of users who use spatial data archives in their work and research and are not experts in the field of spatial data. The survey was divided into three groups of questions. The first group of questions refers to general information about the user, and the goal is to collect information on whether they use archives in their work, for how long and for what purpose. The second group of questions is about the use of data archives. In this group of questions, the aim was to examine which archives users use most often and to gain insight into general opinions of users about archives such as whether they think that archives are tailored to a specific group of users, how much time they spent searching data, are they satisfied with distribution and retrieval of data, are there adequate metadata, what problems they encounter and are the data understandable. The third group of questions refers to the assessment of user needs. All individual components of SDI are considered, and user had to evaluate for each component whether it should be added or improved to make access to data more efficient. A total of 21 responses to the first survey were received.

The second survey was sent to a group of GI users who are not experts in the field of space sciences but in the field of spatial data and have used SDI portals in their work or education. As these users do not use space data archives, to access the survey, they had to solve a given task to get acquainted with the way archives work and how to access data. The task for these users was to use the PDS archive and try to find and retrieve any data collected by observing Mars or Mercury, which is spatially defined. It was necessary to find and download vector or tabu-lar data with a spatial reference in one of the offered formats. They needed to find data formats that are usable in standard GIS tools. Products such as carto-graphic maps or ortho-mosaics are not accepted as a successfully completed task. The purpose of this task is to examine whether an expert in the field of spatial data can find data of interest using tools and services within the PDS. Also, part of the task was to download the relevant metadata, and users had to independently investigate metadata and try to understand what downloaded data present and investigate can they use the data for further analysis in one of the GIS tools. De-pending on successfully completed task, the survey consisted of a total of 31 questions for those who managed to find data of interest, and 25 questions for users who failed to find data. Questions were divided into three groups of questions. The first group of questions is related to basic information about users, their field of work, level of education and familiarity with

the concept of SDI. The second group of questions is separated depending on success in solving the task. If the user successfully completed the task, they answered questions about which portal they used, which tools, how much time they spent on searching the data and about the experiences when using the archive. If the user did not successfully complete the task, the questions were about which portal they used, how much time they spent trying to find data, and about the experiences when using the archive. The third group of questions refers to the assessment of user needs. All individual components of SDI are considered, and user had to evaluate for each component whether it should be added or improved to make access to data more efficient. A total of 65 responses to the first survey were received.

Both surveys were conducted during December 2021 and were open for 14 days. Most of the questions in both surveys were closed-ended where users chose between pre-offered answers. While such questions may not explore every user preference in detail, they provide a valuable source of information and are more commonly used in surveys because users are more likely to be willing to answer this type of question than open-ended questions.

4.2. RESULTS

Responses to the Survey came from 18 different countries (4 continents) which satisfies the condition that the survey is global. Since two surveys were sent, different groups of users were included. The majority of the total survey participants (56%) are employed at a university or a research center, and the most of user have level of education of Doctor of Science. Of the total number of users, as can be seen in Graph 1, 72% are familiar with the concept of SDI, and 94% users have used GIS tools for data analysis and processing of data in their work so far.

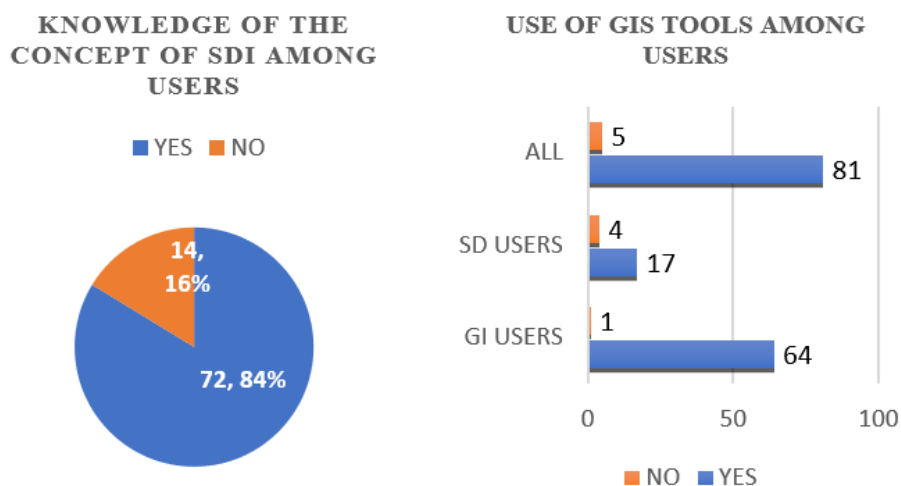

Figure 1. Knowledge of the concept of SDI (left) and GIS tools (right) among survey users

All SP users of survey use space research data in their work, and 90% of them use archives to download data. Graph 2 shows the role of the organization in which they are employed regarding the use of space data. Most respondents are end users of the data, followed by users who use this data for educational purposes. Also, of all SP users, 48% have been working for more than 10 years with space data, while no one has been working in this domain for less than 1 year. Most users use the archives several times a week, and Graph 2 shows that most users use the PDS archive in their work. After PDS, the most used portals are JMars / JMoon and Astropedia by USGS.

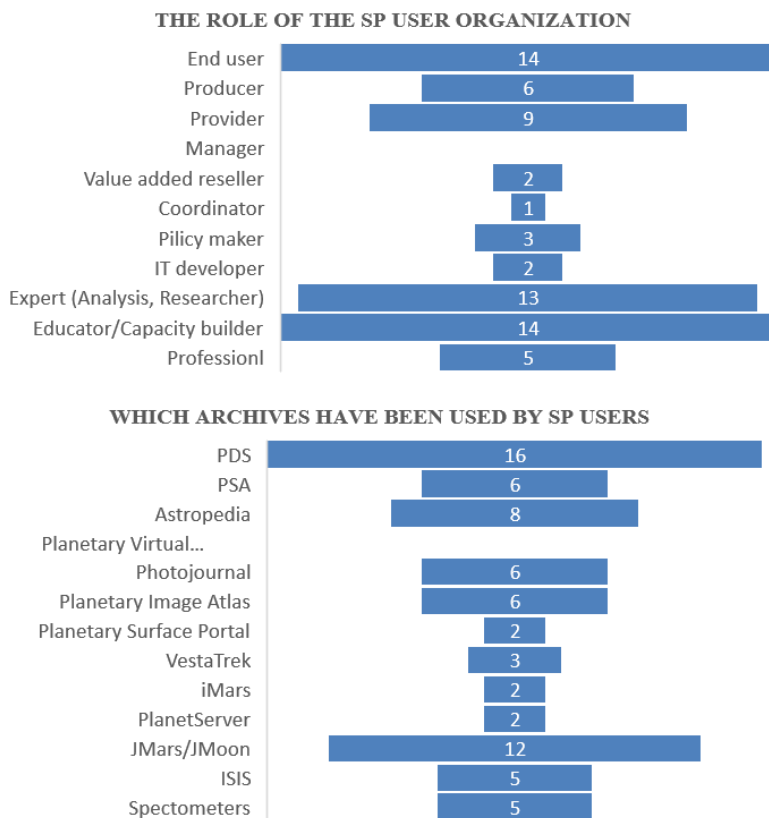

Figure 2. The role of organization regarding the use of space data in which SP users are employed (up) and archives SP user used so far in their work (down)

The second part of the survey gives us an insight into the experience of using archives. Among SP users, only 5% do not think that the archives are partially or completely adapted for scientists in the field of space research, and as the biggest shortcoming they state, “the need for prior knowledge for using the archives” and “lack of data visualization”. All SP users indicated that they encounter some problems in finding data, and as can be seen in Graph 3, most users state that they need more than one hour to find data of interest. Most of SP users (81%) believe that data is always open and accessible to everyone, and the most common access they use to download the data is direct access through archives.

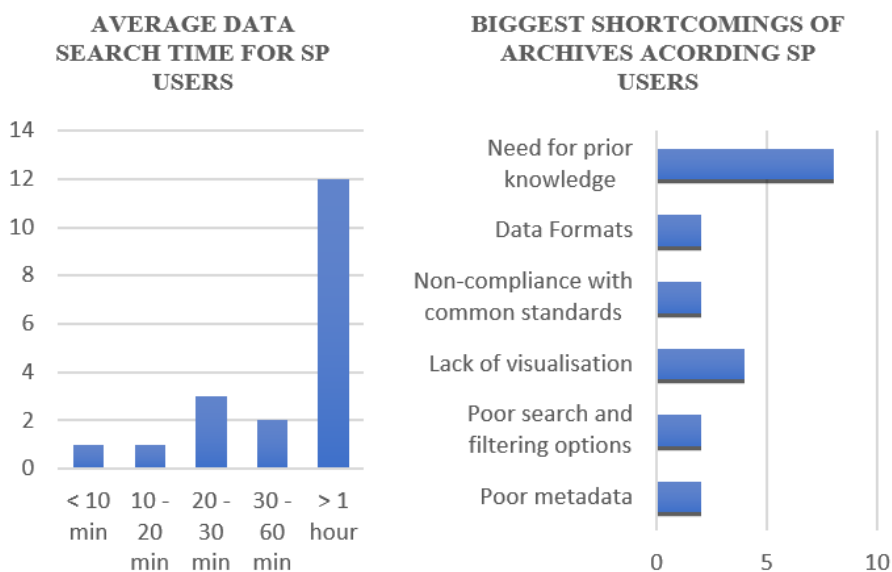

Figure 3. Average search time for data by SP users (left) and shortcomings of archives (right)

Among the GI users, the task was successfully completed by 60% of them. Most users used the PDS archive to search the data, and a total of 62% of users used some other available additional tools and services. Only 2 users spent less than 30 minutes to find the data, while most users, as shown in Graph 4, needed more than 1 hour and even up to several hours. The most of users (58%) also used additional resources and tutorials (e.g. YouTube) in order to achieve the required results.

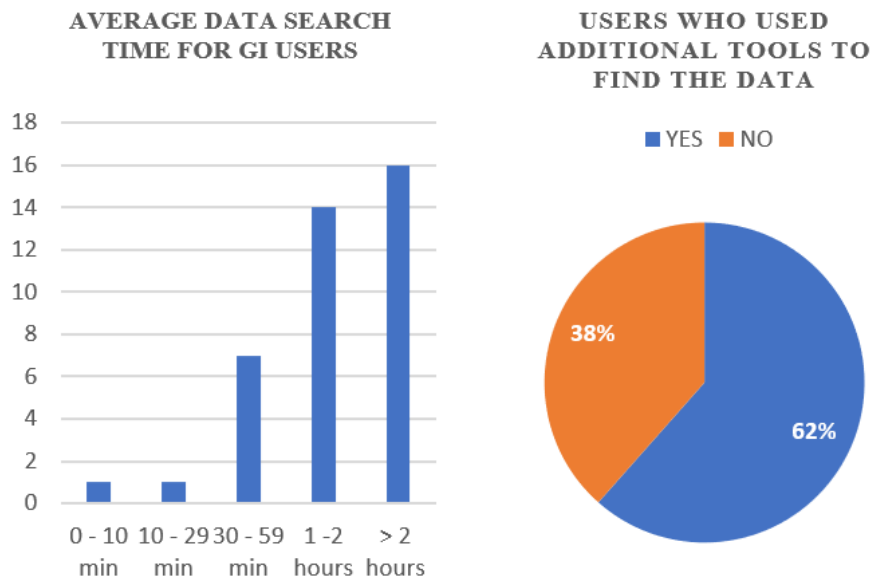

Figure 4. Average data search time (left) and the use of additional search tools (right) among GI users

In the third part of the UNS, user requests for improved archives that would enable better search and retrieval of space research data were examined. Some aspects of the improvement were examined in both user groups, while some specific ones were only examined among SP user groups due to previous experiences in the use of archives. The results of both surveys were combined, and requests for improvement were obtained in joint graphs.

Graph 5 shows that over 80% of respondents believe that archives are not user-friendly, not intuitive, and not easy to use. More than 90% of them believe that the tools currently available do not facilitate data retrieval and that the data should be tailored and accessible to everyone, not just space science users.

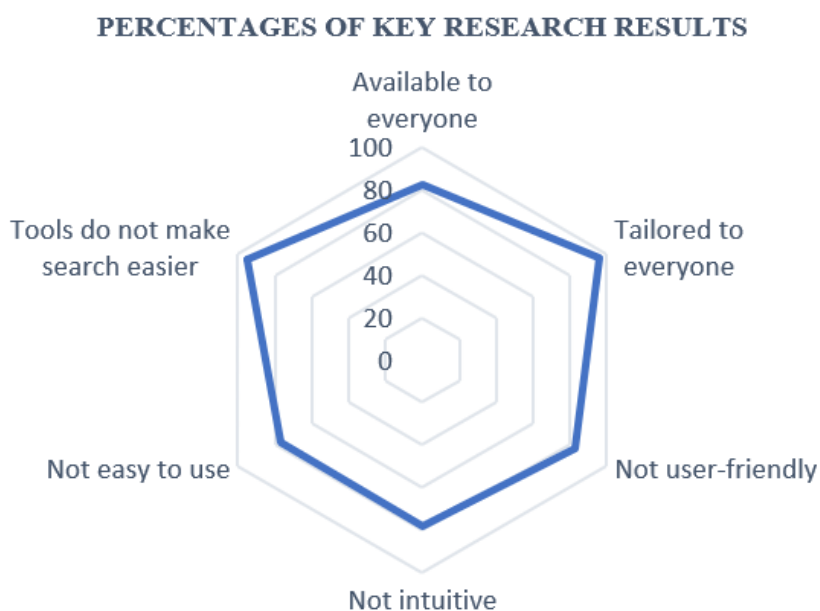

Figure 5. Percentages of key research results in use of space data archives by both group of users

Graph 6 shows the results of the analysis in the range of grades from one to five (grade one is considered not to need changes, and grade five that major changes are needed) depending on how users think that change is needed for each examine component, and each of these components are the basic parts of the future SDICB concept. The graph shows that all components were rated higher than three, which indicates the fact that it is necessary to introduce changes in all of them. The highest ratings, i.e., the biggest need for changes expressed by users, are needed for the user interface (4.31) and the establishment of a single metadata catalog (4.05). Users stated that better methods of data visualization are need-ed (4.09), as well as search (3.76) and data filtering (3.98) options. Also, the need to introduce new standards that are globally open and accepted is graded 3.84 by users, and the change in metadata was graded 3.39. In terms of data formats, this component was only evaluated by SP users as GI users were pre-set by task which formats to download. The need to change the format was graded with 3.52.

THE NEED FOR CHANGES IN DATA DISTRIBUTION

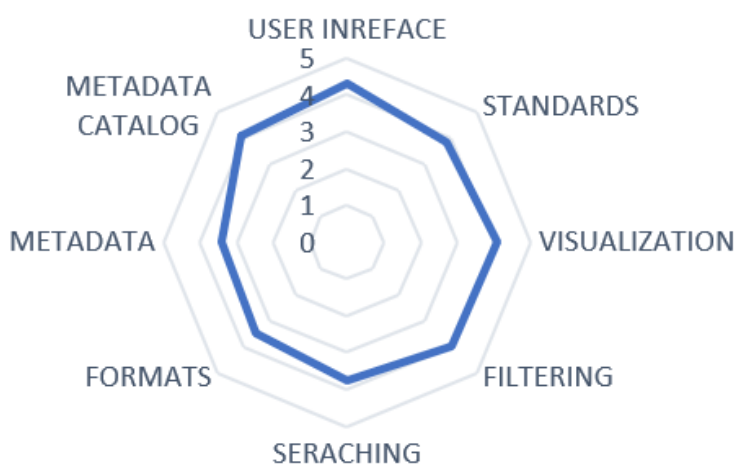

Figure 6. The need for changes in data distribution graded by users

Graphs 7 show that only 54% of GI users, who successfully solved the task, understood the data, i.e., that the metadata was clearly defined according to them. Regarding the data format, only 29% of SP users believe that the formats are satisfactory, and 62% users encounter the problem of data loss during the transformation into other formats. Also, only 33% of respondents believe that the data are fully usable.

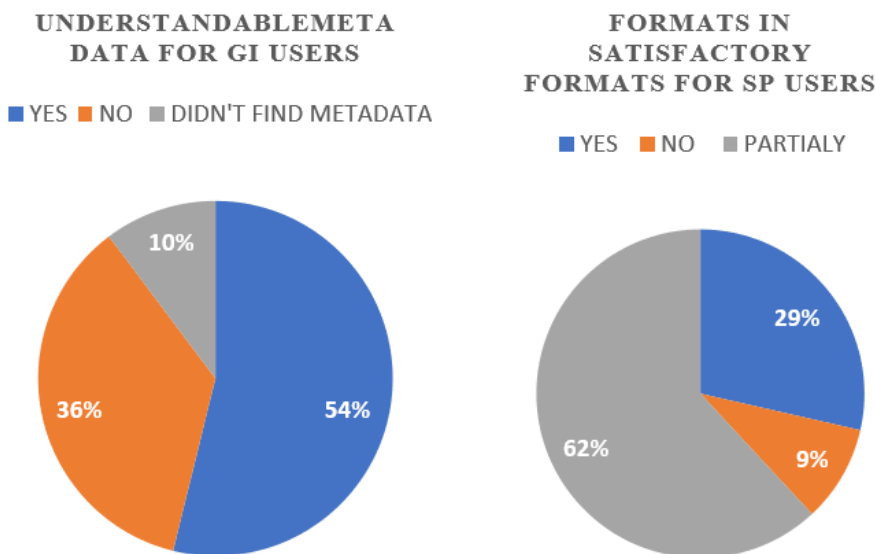

Figure 7. Understandable metadata for GI users (left) and satisfaction with data formats for SP users (right)

Finally, Graph 8 shows the user's opinion on what the SDICB users' domain should be. Among all users 82% of them believe that the data should be available to everyone, not just space scientists, and only 5% of users believe that the current situation is satisfactory, and that archives should serve only the space community.

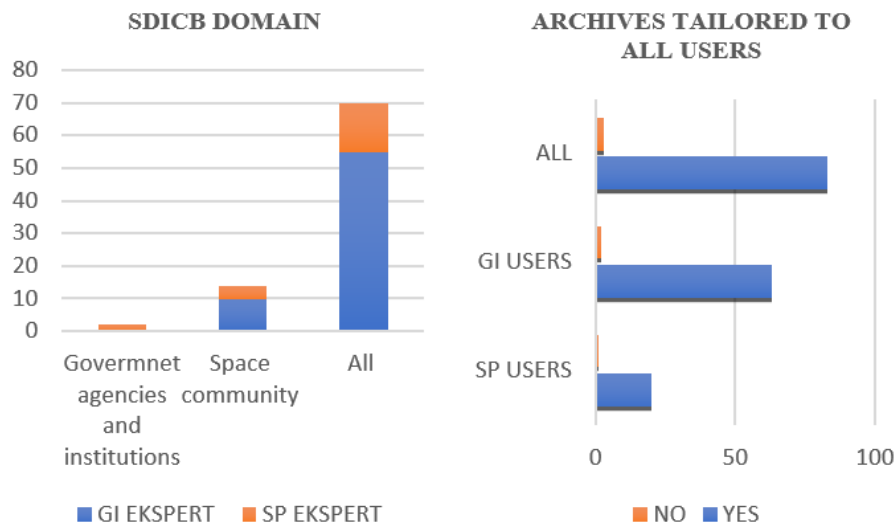

Figure 8. User thoughts on the SDICB domain (left) and customizing the archive for all users (right)

4.3. DISCUSSION

The conducted UNA provides a detailed insight into the user experience when using existing methods of access to space data, but also about the needs of users for more efficient use and exploitation of space research data. The analysis covered almost all aspects of one SDI concept (except policies) and collected input data to establish guidelines based on which the SDICB should be implemented. Relevant answers were received from current users of the archives, but also from other users who could use these archives in the future. The research shows that the PDS archive is the most used, but that its use requires certain prior knowledge such as knowledge of the missions that collected data, but also knowledge about time when data is collected, and about professional labels used in documenting data. The average time required to find data is over an hour for all user groups, and users often encounter various problems in the data search. Data is open and accessible to everyone, but there are too many tools and services to search for it, and there is a problem of data scattering and users' lack of knowledge about which tool to use to find data of interest. Over 80% of respondents believe that archives are not user-friendly, not intuitive, and not easy to use. More than 90% of them believe that the tools do not facilitate the search for data and that the data should be tailored to everyone, not just users in the field of space science. Users assessed that the need for changes is necessary in almost all aspects and that the current ways of distributing metadata, their content, data formats, but also the ways of searching data and user interface are not at a satisfactory level.

5. CONCLUSION

The increased interest in space research data that has emerged over the past few years has raised questions about access to this data for all groups of users. Current ways of archiving data are tailored to the space community, while other user groups face many problems when searching and downloading data. The best solution to this problem is to establish an SDICB concept that would allow all users easy access to data and enable better management and exploitation of space research data. So far, several initiatives have been launched to improve the availability of this data, and by accepting the recommendations of these initiatives in the framework of the implementation of the SDICB, the data would become interoperable, understandable, and usable for all user groups. The SDICB should be user-oriented, so the needs of different user groups were assessed as part of this research. A global survey for user needs assessment was conducted, which included users of space data and archives and experts in the field of spatial data. A total of 86 responses were received and from the results of the survey it is evident that requests of users for changes are permeated in all components of the SDICB initiative. For example, users feel that current solutions are not user-

friendly, are not intuitive and easy to use, and that the tools do not simplify data retrieval. According to users, searching methods for this data should be tailored to all user groups. To enable this needs it is necessary to introduce a change in the way of storing and distributing metadata, introduce understandable and generally accepted standards and data formats and improve data search, filtering, and visualization options. The obtained results will serve as input for the establishment of guidelines based on which the SDICB concept will be implemented.

LITERATURE

- [1] W. Li, S. Wang, V. Bhatia, "PolarHub: A large-scale web crawling engine for OGC service discovery in cyberinfrastructure," *Computers Environment and Urban Systems*, vol. 59, pp. 195-207, 2016.
- [2] Y. Hu, W. Li, "Spatial Data Infrastructures", in *The Geographic Information Science & Technology Body of Knowledge*, John P. Wilson, ed., 2017. Available: <http://gistbok.ucgis.org/bok-topics/spatial-data-infrastructures> [March 04, 2022].
- [3] S. Ključanin, V. Poslončec-Petrić, Ž. Bačić, *Osnove infrastrukture prostornih podataka*, Sarajevo, Dobra knjiga, 2018, pp.9-35.
- [4] V. Cetl, "Infrastrukture prostornih podataka", *Ekscentar*, vol 6. (6), pp.36–38., 2004.
- [5] A. Rajabifard, I. P. Williamson, "Spatial data infrastructures: concept, SDI hierarchy and future directions", in Proc. *GEOMATICS'80 Conference*, 2001.
- [6] D. Breuer, J. L. Grenfell, M. Grot, E. Hauber, H. Hussmann, J. Jänchen, M. Knapmeyer, J. Oberst, F. Sohl, T. Spohn, K. Stephan, R. Wagner, F. Wagner, M. Wählich, "Landolt-Börnstein - Group VI Astronomy and Astrophysics, Astronomy, Astrophysics, and Cosmology" in *Solar System*, vol 4B, J.E. Trümper, ed., 2009, pp.560-630.
- [7] Mapping and Planetary Spatial Infrastructure Team, "Mapping and Planetary Spatial Data Infrastructure Roadmap 2019 – 2023", MAPSIT, 2019, Available: <https://www.lpi.usra.edu/mapsit/roadmap/MAPSIT-Roadmap-2019-06-19.pdf> [March 09, 2022].
- [8] R. M. Borden, B. W. Bishop, "Assessing Planetary Data Access and Use", in Proc. 4th Planetary Data Workshop, LPI Contribution No. 2151, 2019.
- [9] T. M. Hare, A. P. Rossi, A. Frigeri, C. Marmo, "Interoperability in planetary research for geospatial data analysis", *Planetary and Space Science*, Vol. 150, pp.36–42., 2018.
- [10] T. M. Hare, L. Keszthelyi, L. R. Gaddis, "Online Planetary Data and Services at USGS Astrogeology, Astrogeology Science Center", in Proc. 45th Lunar and Planetary Science Conference, ID 2487, 2014.
- [11] T. M. Hare, A. P. Rossi, A. Frigeri, C. Marmo, "Interoperability in Planetary Research for Geospatial Data Analysis", *Planet. Space Sci*, Vol 150, pp.26-42., 2018.
- [12] T. Morgan, M. Banks, "NASA's Planetary Data System Status and Future Plans", Report to the Planetary Advisory Council, NASA, 2018, Available: <https://www.lpi.usra.edu/pac/presentations/0218/Morgan.pdf> [March 05, 2022]
- [13] C. Marmo, T. M. Hare, S. Erard, B. Cecconi, F. Costard, F. Schmidt, A. Rossi, "FITS Format for Planetary Surfaces: Bridging the Gap Between FITS World Coordinate Systems and Geographical Information Systems", in Proc. *Lunar Planet Science Conference LXXVIII*, ID 1870, 2016.
- [14] L. Keszthelyi, T. Becker, T. Titus, S. Sides, L. Gaddis, T. Hare, R. Kirk, K. Edmundson, J. Anderson, "Utilizing the Integrated Software for Imagers and Spectrometers (ISIS) to Support Future Missions", in Proc. *Lunar Planetary Science Conference XLV*, ID 1686, 2014.
- [15] J. A. Skinner, T. M. Hare, C. M. Fortezzo, M. A. Hunter, "Planetary Geologic Mapping Handbook", U.S. Geological Survey. Astrogeology Science Center, 2014, Available: <https://planetarymapping.wr.usgs.gov/Page/view/Guidelines> [March 02, 2022]
- [16] J. R. Laura, T. M. Hare, L. R. Gaddis, R. L. Ferguson, J. A. Skinner, J.J. Hagerty, B. A. Archinal, "Towards a Planetary Spatial Data Infrastructure", *ISPRS International Journal of Geoinformatics*, vol.6(6), 181, 2017.
- [17] J. R. Laura, M. Bland, R. L. Fergaso, T. M. Hare, B. A. Archinal, "Framework for the Development of Planetary Spatial Data Infrastructures: A Europa Case Study", *Earth and Space Science*, vol. 5, pp.486-502, 2018.
- [18] S. Hennig, M. Belgui, "User-centric SDI: Addressing users' requirements in third generation SDI. The example of nature-SDIplus", in Proc. *Geoforum Perspektiv 10*, 2011.

47

Review paper | Прегледни научни рад

DOI 10.7251/STP2215487M

ISSN 2566-4484



Anastasija Martinenko, University of Belgrade, amartinenko@grf.bg.ac.rs

Ljiljana Brajović, University of Belgrade, brajovic@grf.bg.ac.rs

Miodrag Malović, Faculty of Technology and Metallurgy, office@malovic.in.rs

INFLUENCE OF MATERIAL SURFACE ROUGHNESS ON BACKSCATTERING IN LASER SCANNING

Abstract

In this paper, the possibility of applying Kirchhoff's scalar approximation model for determining the backscattering coefficient from rough surfaces is investigated. Surfaces of dielectric and metallic materials, which have low roughness are considered. Based on the roughness parameters and electrical properties of these materials, the backscattering coefficient is modelled as a function of the incident angle of electromagnetic radiation used in laser scanning. It was represented that the type of scattering and the range of backscattering radiation angles, in the case of seemingly smooth surfaces, vary significantly when the roughness parameters change.

Keywords: Kirchhoff's scalar approximation model, Roughness parameters, Laser scanning, Backscattering coefficient.

УТИЦАЈ ХРАПАВОСТИ ПОВРШИНЕ МАТЕРИЈАЛА НА ПОВРАТНО ЗРАЧЕЊЕ КОД ЛАСЕРСКОГ СКЕНИРАЊА

Сажетак

У овом раду испитивана је могућност примене Кирхофовог модела скаларне апроксимације за одређивање коефицијента повратног расејања од храпавих површина. Разматране су површине диелектричних и металних материјала које имају малу храпавост. На основу параметара храпавости и електричних особина тих материјала, моделиран је коефицијент повратног расејања у зависност од упадног угла електромагнетског зрачења које се користи код ласерског скенирања. Показано је да тип расејања и опсег углова повратног расејања, код привидно глатких површина, вишеструко варирају при промени параметара храпавости.

Кључне ријечи: Кирхофов модел скаларне апроксимације, Параметри храпавости, Ласерско скенирање, Коефицијент повратног расејања.

1. INTRODUCTION

Many measurement methods in geodesy are based on measuring the characteristics of reflected electromagnetic (EM) waves from an object or a surface. The intensity and direction of the reflected radiation are influenced by the characteristics and direction of the incident radiation, the electrical and magnetic properties of the material, and the geometric characteristics of the reflecting surface. Knowledge of the physical principles on which the reflection of EM radiation from different types of surfaces is based as well as its influence on the measurement signal, enables prediction of measurement errors, and allows the use of these measurement systems to identify different types of surfaces [1,2].

Terrestrial laser scanner (TLS) provides accurate, high-resolution data by measuring the distance between scanned points and the scanner center using time-of-flight or phase-shift-based methods. Distance measurement accuracy in TLS depends on the instrument mechanism, atmospheric conditions, scanning geometry, and target surface properties [13].

In active laser systems, the reflection of waves from real surfaces which are generally rough is used. If the surfaces under consideration are highly reflective, whose specular reflections are dominant, significant errors (centimeter and even decimeter levels) may occur, because these reflections can increase the backscattered laser signal power considerably and cause further disturbance in echo detection and recognition by TLS photodetectors [13].

The application of lasers is based on the directivity and modulation of the laser beam, and on the reception and processing of reflected laser radiation from the surface of the object. In applications based on the reception and processing of reflected laser radiation, information is contained in the change of amplitude, phase and frequency of the reflected signal. The phase change and return time of the reflected signal is used to measure the distance from the object. The distribution of the intensity of reflected radiation, as a function of incident and reflected angles, depends on the properties of the tested material (roughness and electrical and magnetic properties), the properties of electromagnetic radiation (wavelength and polarization). There are different models for calculating and analyzing the intensity of reflected EM waves from the surface of the object and these models depend on the parameters of material roughness and the properties of laser radiation. There is no single model for calculating the reflection from rough surfaces and for all models there are some boundary conditions of use because they are all based on some kind of approximation.

Intensity-based method for correcting distance measurement errors from the center of the scanner to the object is presented in [13], where distance and intensity data are directly derived from the characteristics of backscattered signals. Roughness of the surface is one of the main features for modeling distance errors.

This paper describes the scattering (reflection) of radiation from rough surfaces and applies Kirchhoff's model of scalar approximation to several surfaces of different materials and different roughness parameters. Kirchhoff's model presents a rough surface as randomly oriented small mirrors that touch the surface [3]. For these mirrors, depending on their orientation in space and the type of material, Fresnel reflection coefficients are obtained for parallel and perpendicular polarized incident electromagnetic waves [3-5]. The paper explains the criteria for determining whether a surface is rough and the parameters that more closely describe the surface roughness as well as the range of parameter values for which Kirchhoff's scalar approximation model is applied. In laser scanning, in addition to the material properties of the surface to be scanned, the intensity of the backscattered radiation depends on the incidence angle. For surfaces that are slightly rough and seemingly smooth, such as dielectrics (glass and plastic) and metals (copper and iron), the angular distribution of backscattered radiation has been determined as a function of the incident angle.

2. THEORY

2.1. REFLECTION OF ELECTROMAGNETIC WAVES FROM FLAT SURFACES

EM waves represent the transmission of oscillations of electric and magnetic fields through space. For laser scanning applications, plane EM waves are generally considered. The electric and magnetic fields are normal to each other and normal to the direction of propagation of these waves. Electromagnetic waves for many applications can be represented by its electric field vector \vec{E} . When a plane EM wave incidents on a flat boundary surface between two homogeneous media (1 and 2), whose refractive indices are n_1 and n_2 it is partially refracted and partially reflected (Figure 1). The direction of the incident EM wave and the normal to the surface make the incident angle θ_1 . The part of the ray wave is reflected back to the media 1 at the same angle θ_1 , and the part is refracted

and passes to the medium 2. The direction of the refractive wave makes the angle θ_2 with the normal to the boundary surface. The incident, reflected and refractive rays and the normal to the boundary surface lie in the same plane called the incident or incident plane. The incident EM wave is usually represented as the sum of two linearly polarized waves, the first whose electric field vector \vec{E}_{par} is parallel to the incident plane and the second whose electric field vector \vec{E}_{perp} is normal to the incident plane, so the incident wave vector is represented as $\vec{E} = \vec{E}_{\text{par}} + \vec{E}_{\text{perp}}$. In order to represent the intensity of the reflected wave vector \vec{E}' , the reflection coefficient r is determined, which represents the ratio of the intensity of the electric field vector of the reflected and incident waves. Due to the representation of the incident wave over the mutually normal two polarized waves, this coefficient is determined for each polarization separately. The reflected wave can be represented as \vec{E}'_{par} and \vec{E}'_{perp} , so two reflection coefficients r_{par} and r_{perp} are determined. Reflection coefficients can be determined using the laws of refraction and reflection of waves and boundary conditions that connect their electric and magnetic field vectors at the boundary surface, as well as knowledge of dielectric constants of materials ε_1 and ε_2 and their magnetic permeabilities μ_1 and μ_2 . They are called Fresnel coefficients.

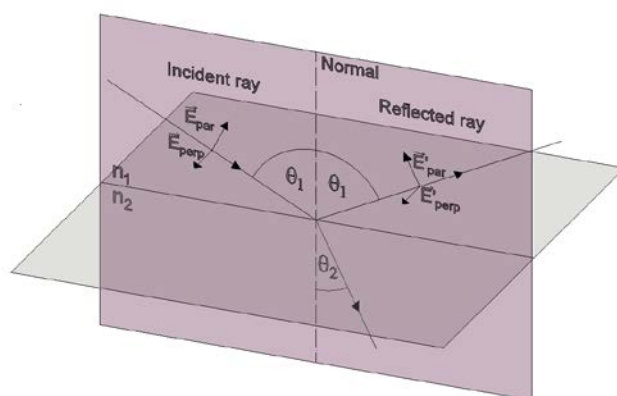

Figure 1. Reflection and refraction of EM waves from a flat boundary surface

Fresnel reflection coefficients, in the general case, for media that have pronounced electrical and magnetic properties can be determined from the expressions [3]:

$$r_{\text{perp}} = \frac{Z_2 \cos \theta_1 - Z_1 \cos \theta_2}{Z_2 \cos \theta_1 + Z_1 \cos \theta_2}, \quad (1)$$

$$r_{\text{par}} = \frac{Z_2 \cos \theta_2 - Z_1 \cos \theta_1}{Z_2 \cos \theta_2 + Z_1 \cos \theta_1}. \quad (2)$$

In these expressions $Z_1 = \sqrt{\frac{\mu_1}{\varepsilon_1}}$ and $Z_2 = \sqrt{\frac{\mu_2}{\varepsilon_2}}$ represent the characteristic impedances of the media. However, in practice majority of the materials do not have pronounced magnetic properties and their magnetic permeability $\mu \approx 1$. In addition, it is assumed that the medium 1 from which the incident wave comes is air, whose characteristic impedance is $Z_1 = \sqrt{\frac{1}{\varepsilon_0}}$, and the medium 2, in the general case, is the absorbing medium of the relative dielectric constant ε_{r2} . In this case, the Fresnel reflection coefficients are represented by the expressions:

$$r_{\text{perp}} = \frac{\cos \theta_1 - \sqrt{\varepsilon_{r2} - \sin^2 \theta_1}}{\cos \theta_1 + \sqrt{\varepsilon_{r2} - \sin^2 \theta_1}}, \quad (3)$$

$$r_{\text{par}} = \frac{\sqrt{\varepsilon_{r2} - \sin^2 \theta_1} - \varepsilon_{r2} \cos \theta_1}{\sqrt{\varepsilon_{r2} - \sin^2 \theta_1} + \varepsilon_{r2} \cos \theta_1}. \quad (4)$$

If the medium 2 is absorptive, a complex number is used to represent its relative dielectric constants ε_{r2} . The most common way of presentation complex relative dielectric constants is:

$$\varepsilon_{r2} = \varepsilon_2' - i\varepsilon_2'', \quad (5)$$

where $i^2 = -1$, ε_2' is the real part of the relative dielectric constant, and ε_2'' is the imaginary part of the relative dielectric constant. The refractive index of the same energy-absorbing material is represented by a complex number as follows:

$$n_2 = m_2 - ik_2, \quad (6)$$

where m_2 and k_2 are the real and imaginary part of the refractive index. Complex index of refraction and complex relative dielectric constant and their real and imaginary parts are connected based on the expression:

$$n_2 = \sqrt{\varepsilon_{r2}}. \quad (7)$$

In case the material does not absorb energy from EM wave its the relative dielectric constant ε_{r2} and index of refraction n_2 are real numbers. As the medium 1 has a refractive index $n_1 = 1$, the reflection coefficients in this case can be derived from:

$$r_{\text{perp}} = \frac{\cos\theta_1 - \sqrt{n_2^2 - \sin^2\theta_1}}{\cos\theta_1 + \sqrt{n_2^2 - \sin^2\theta_1}}, \quad (8)$$

$$r_{\text{par}} = \frac{\sqrt{n_2^2 - \sin^2\theta_1} - n_2 \cos\theta_1}{\sqrt{n_2^2 - \sin^2\theta_1} + n_2 \cos\theta_1}. \quad (9)$$

2.2. REFLECTION OF ELECTROMAGNETIC WAVES FROM ROUGH SURFACES

Roughness is a measure of statistical variation in the distribution of topographic surface relief. [8] For rough materials, the surface level changes, and can be represented by a two-dimensional function $z(x, y)$, in the general case.

For simplicity of presentation and development of basic models, rough surfaces are observed along one direction x , and its height is represented as $z(x)$. The mean height $\langle z \rangle$ for all values of x in the observed range is determined. A large number of parameters can be used to describe surface roughness, but two parameters are most commonly used on which the basic models of EM wave scattering from rough surfaces are based. The first parameter is the mean square variation of the height Δh which is the simplest measure of surface roughness (Figure 2). [3] And it is determined based on:

$$\Delta h = \sqrt{\sum (z(x) - \langle z \rangle)^2}, \quad (10)$$

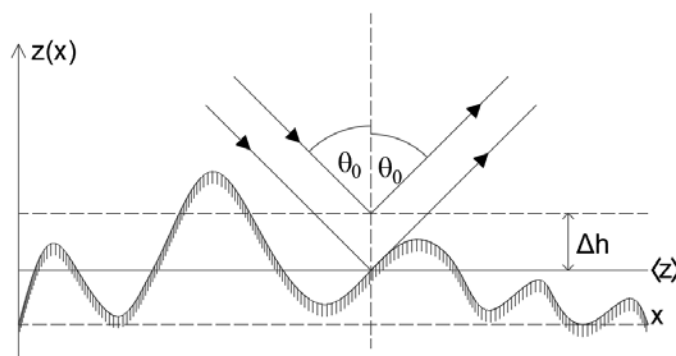

Figure 2. Surface level presentation by function $z(x)$ and parameter Δh

However, this parameter only tells about the deviation of the surface height from the mean value, but it does not tell about the spatial periodicity of these changes, so it is necessary to determine the characteristic period of repetition of height oscillations along the x -axis. This is most often represented by an autocorrelation function defined as [10]:

$$\rho(\xi) = \frac{\sum (z(x+\xi) - \langle z \rangle)(z(x) - \langle z \rangle)}{\Delta h^2}, \quad (11)$$

and it is a measure of the similarity of height at two distant points along the x axis at a distance ξ . By definition, the limit values of this quantity are $\rho(0) = 1$, and most often $\rho(\infty) = 0$.

The most commonly used models for this autocorrelation function are:

- Gaussian distribution

$$\rho(\xi) = e^{-\frac{\xi^2}{L^2}} \quad (12)$$

- or negatively exponential distribution

$$\rho(\xi) = e^{-\frac{|\xi|}{L}} \quad (13)$$

In both cases, the quantity L is a measure of the width of the irregularity on the surface and is called the correlation length.

In addition to the basic parameters that most often describe the surface roughness, there are other parameters that in combination with the previously mentioned parameters even better describe the given surface. Some of these parameters are Skewness (Sk), Peak to valley height (PVh) and Root mean square slope (RMS slope). Skewness is a measure which describes a degree of asymmetry from the normal distribution of surface heights. This parameter is using very often in a combination with the standard deviation or other indices that assume the normal distribution of surface heights. The index can be calculated by:

$$S_k = \frac{\frac{1}{N} \sum_1^N (z(x_i) - \bar{z})^3}{\left(\frac{1}{N} \sum_1^N (z(x_i) - \bar{z})^2\right)^{3/2}} \quad (14)$$

A Peak to valley height is a statistical measure which takes the two most extreme heights its maximum h_{max} and its minimum h_{min} of a surface. This index is used in surface metrology where surface roughness is considered as irregularities coming from a manufacturing process. This index can be calculated by the next formula:

$$PVh = h_{max} - h_{min} \quad (15)$$

Root mean square slope represents the root mean square for the local slope dz/dx a long the sampling length,

$$RMS \text{ slope} = \frac{1}{N} \sqrt{\sum_1^N \left(\left(\frac{dz(x)}{dx} \right)_{x=x_i} \right)^2} \quad (16)$$

This parameter is in relation with Δh and L and in case of Gaussian distribution, the relation is $RMS \text{ slope} = \sqrt{2} \frac{\Delta h}{L}$.

For ideally rough surfaces, it is often assumed that the height distribution is represented by the Gaussian distribution, because it is the result of a random process. It is also assumed that the correlation function most often has a Gaussian distribution, although sometimes the exponential correlation function corresponds better to the measured surface data [9].

2.3. SURFACE SCATTERING MODELING

Scattering (reflection) of radiation from different types of surfaces (smooth and rough) is one of the basic physical processes used to characterize the surface of the material. Based on the characteristics of the surface, the angle at which the scatter radiation is greatest can be determined. Therefore, the consideration of the reflection properties of real surfaces is of great importance. Simple surface scattering models describe two boundary surface types, an ideally smooth surface (mirror) and an ideally rough surface. If the surface that scatters radiation is smooth enough, it will act as a mirror, and such scattering is called specular reflection and will behave according to the law of reflection, ie. all incident radiation will be reflected at the same angle as the incident radiation. The second basic behavior occurs when the surface is ideally rough and is called Lambertian scattering. In this type of scattering, radiation that incidents at some angle and is uniform per unit area, is reflected in all directions, ie. the radiation is scattered at all angles isotropically as presented in Figure 3.

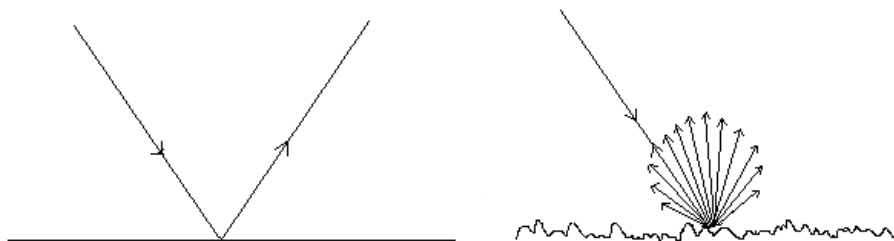

Figure 3. Schematic representation of two boundary cases of surface scattering a) Specular reflection; b) Lambert scattering (Based on Fig.1 in [12])

Therefore, scattering from rough surfaces cannot be represented only by Fresnel coefficients, but it is necessary to introduce other coefficients related to scattering.

The basic coefficient of scattered surface radiation is BRDF (*Bidirectional Reflection Distribution Function*) and it is a function of the directions of the incident and scattered radiation, so it can also be written as a function R of $(\theta_0, \phi_0, \theta_1, \phi_1)$. It represents the ratio of the irradiance L_1 of scattered radiation in the direction described by angles (θ_1, ϕ_1) to the unit spatial angle $d\Omega_1$ and the flux F of incident radiation from the direction represented by angles (θ_0, ϕ_0) to the surface dA (Figure 4). This presentation is useful because it emphasizes reciprocity in relation to the directions of incident and scattered radiation, ie.

$$R(\theta_0, \phi_0, \theta_1, \phi_1) = R(\theta_1, \phi_1, \theta_0, \phi_0). \quad (17)$$

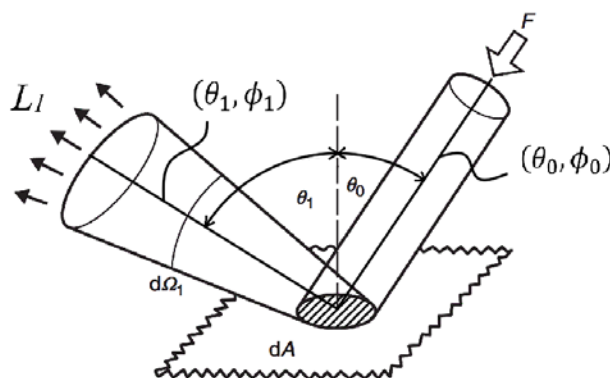

Figure 4. Based on Fig. 3.9. [3] Quantities defining scattered radiation from a rough surface dA (azimuth angles ϕ_0 and ϕ_1 are not completely represented due to image clarity)

Most laser systems detect only the radiation scattered backward, ie. which returns along the same path as the incident radiation. When $\theta_0 = \theta_1$ and $\phi_0 = \phi_1$, such backscattered radiation is most often represented by the dimensionless backscattering coefficient, σ^0 represented by the following expression:

$$\sigma^0 = 4\pi R \cos^2 \theta_0. \quad (18)$$

There is no surfaces that are absolutely rough or smooth, but it depends on the wavelength of the incident electromagnetic radiation. Therefore, criteria are introduced based on which it can be approximately determined whether the surface can be considered rough or smooth, and one of the basic ones is the Rayleigh criterion. Figure 2 schematically shows the behavior of radiation that falls on a rough surface at an angle θ_0 and is reflected from it at the same angle. Observing two parallel rays falling on that surface, it is introduced that one is reflected from the reference plane whose height is equal to the middle level of the surface $\langle z \rangle$, and the other from the parallel plane which is at the height Δh above this reference plane. After scattering, the difference between the traversed paths of these two rays is $2\Delta h \cos \theta_0$, and their phase difference is:

$$\Delta\phi = \frac{4\pi\Delta h \cos \theta_0}{\lambda} \quad (19)$$

where λ is the wavelength of the radiation. As Δh denotes the mean square variation of the rough surface height, so $\Delta\phi$ represents the mean square variation of the scattered beam phase. The surface

can be considered smooth enough for scattering to be specular if $\Delta\phi$ is less than some predefined value of order 1 rad. [3] The usual value is $\pi/2$ and it is characteristic of the Rayleigh criterion. Therefore, for scattering to be specular according to Rayleigh's criterion, Δh must satisfy the condition:

$$\Delta h < \frac{\lambda}{8 \cos \theta_0} \quad (20)$$

From this formula, we can see whether the surface is rough depends on the wavelength of the radiation and the angle of incidence. Based on Equation 17, it is shown that the surface is smooth enough for radiation falling normally on the surface if Δh is less than $\lambda/8$.

2.3.1. Kirchhoff's model of scalar approximation

In this paper, Kirchhoff's model is used to model scattering from rough surfaces. In this model, the randomly rough surface is represented by randomly oriented small mirrors that touch the surface [3]. In this way, scattered radiation is represented by reflected radiation from these small mirrors, so this model is also called tangent plane approximation [5,11].

The three basic assumptions for these model are [5]:

- Tangent plane hypothesis: at each point of the surface, the roughness is assumed to have the same optical behavior as its tangent plane. Fresnel laws can thus be locally applied;
- Fresnel reflection coefficients is independent on the position on the rough surface and on the local angle of incidence;
- Calculations are performed in the far-field.

There are two types of Kirchhoff's model and first one, the stationary phase model is based on the application of the laws of geometric optics and applies to rougher surfaces [3-5,11]. Second, the scalar approximation model is based on the laws of physical optics and is applied to slightly rough surfaces [6]. These surfaces are approximately smooth and their correlation length L is considered to be greater than the wavelength of the radiation, and the mean square value of the surface height Δh is small enough that the slopes of the mirrors are small.

The general equations describing scattering from rough surfaces according to Kirchhoff's model are presented in detail in [5] and [14]. Based on them, different types of scattering coefficient could be derived for various directions of incident and reflected radiation.

The backscattering coefficient for the scalar approximation model for the parallel polarization of the incident radiation is determined according to the expression [6]:

$$\sigma_{pp}^0(\theta) = k^2 L^2 \cos^2 \theta \left| r_p(\theta) \right|^2 \exp(-4k^2 \Delta h^2 \cos^2 \theta) \times \sum_{n=1}^{\infty} \frac{(2k\Delta h)^{2n}}{n!} \exp(-4(k^2 L^2 \sin^2 \theta)/n). \quad (21)$$

In this expression, it is assumed that the correlation length L is determined by the Gaussian autocorrelation function, $r_p(\theta)$ represents the Fresnel coefficient for parallel polarized radiation and the quantity $k = 2\pi / \lambda$ represents the wave number of incident radiation.

Kirchhoff's model of scalar approximation is valid for the following relations of parameters Δh , L and k [3]:

$$\Delta h < 0.18 L, \quad (22)$$

$$kL > 6, \quad (23)$$

$$kL^2 > 17.3 \Delta h. \quad (24)$$

In the Kirchhoff's model, care should be taken to choose appropriate size of the "mirrors", because they must be larger than a few wavelengths, in order to avoid the effect of radiation diffraction. Also, the angles of intrusion and scattering should not be too large, in order to prevent the shading of one part of the surface by another. This model also does not consider multiple scattering.

3. RESULTS AND DISCUSSION

Within the MATLAB software package, programs for determining the Fresnel reflection coefficients and the backscattering coefficient of different materials have been created. These programs enable the calculation for different radiation wavelengths, as well as for different parameters of material surface roughness.

The most often radiation wavelengths λ used in laser scanning are 532 nm and 1064 nm [4], and calculations were performed for these two wavelengths. The considered range of incidence angles is from 0° to 70° . For two types of dielectric materials (glass and plastic) and metals (copper and

iron), the parameters Δh and L were varied to meet the conditions of expressions (22), (23) and (24). Based on them the dependence of the backscattering coefficient on the incident angle was determined.

For the calculation the backscattering coefficient based on Kirchhoff's scalar approximation model, the part of expression (21) representing the infinite sum S is especially considered. Therefore, the value of the n -th term of the sum for $n = [0,10]$ was first calculated according to expression (25), and this is presented in Figure 7 as the dependence $S(n)$. The calculation was performed for different incidence angles from 0° to 70° and it was noticed that the value of the members $S(n)$ behaves in a similar way for all angles from the given range.

$$S(n) = \frac{(2k\Delta h)^{2n}}{n!n} \exp(-4(k^2 L^2 \sin^2 \theta)/n). \quad (25)$$

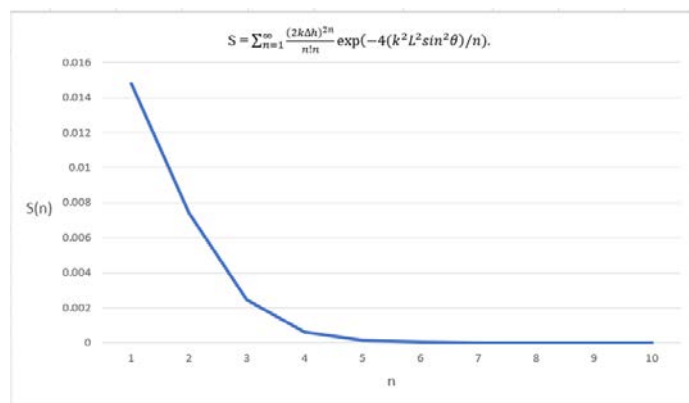

Figure 5. Sum chart for members 1 to 10

Based on the obtained results shown in the Figure 5, it is obvious that the influence of the members with $n > 5$ on the summation is negligible. So the sum in expression (21) is calculated based on the first 5 members. For all materials that are modeled, the adopted values for Δh and L are shown in Table 1.

Table 1. Adopted values of roughness parameters Δh and L for wavelength 532 nm

Δh [μm]	L [μm]
0.02	0.8
0.04	1.6
0.12	4.8

The obtained results are shown only for the wavelength 532 nm, since the results of the wavelength 1064 nm do not differ significantly from them.

3.1. GLASS

The refractive index for glass is a real number and is 1.5261 for a wavelength 532 nm. Fresnel reflection coefficients were determined based on expressions (8) and (9) and presented as graph in Figure 6a). The values of the backscattering coefficient were calculated for two ways of varying the roughness parameters:

- at a constant value of L (1.6 μm) for different values of Δh (0.02 μm , 0.04 μm and 0.12 μm) which is shown in Figure 6b),
- at a constant value of Δh (0.04 μm), and for different values of L (0.8 μm , 1.6 μm and 4.8 μm), which is shown in Figure 6c).

On smooth surfaces the radiation is reflected backwards in a narrow range of angles, while on rough surfaces the backscattered radiation is distributed over large range of angles. As the value of Δh increases, the surface becomes rougher, while as the value of L increases, the surface becomes smoother, which can be seen in the pictures below.

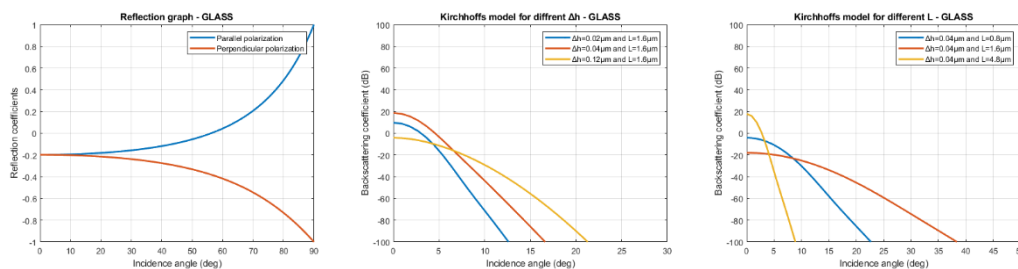

Figure 6. Angular dependence of: a) Fresnel reflection coefficients for glass material, b) Backscattering coefficient at L constant, c) Backscattering coefficient at Δh constant

Based on graphs 6b), it can be seen that at a constant value of L, at higher Δh the surface scattering by type is closer to Lambert scattering, and at lower Δh it is closer to "mirror" scattering.

3.2. PLASTIC

The refractive index for plastics (plexiglass) is 1.4937 for a wavelength 532 nm. The results are presented in Figures 7a), 7b) and 7c).

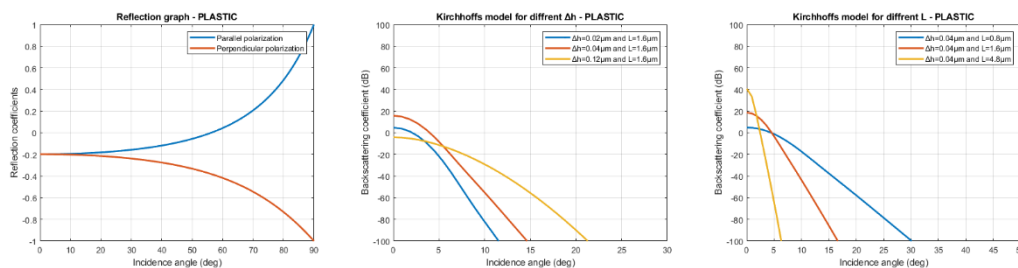

Figure 7. Angular dependence of: a) Fresnel reflection coefficients for plastic material, b) Backscattering coefficient at L constant, c) Backscattering coefficient at Δh constant

Since glass and plastic materials have similar reflection characteristics, ie. they have approximately the same values for the refractive index, the graphs of reflection and graphs of the dependence of the backscattering coefficient on the incidence angle are similar.

3.3. COPPER

The refractive index for copper is represented by the complex number 1.1159-2.5956i for a wavelength 532 nm. The calculation of Fresnel coefficients and the backscattering coefficient was done in the same way for the previous materials. The results are shown in Figure 8a), 8b) and 8c).

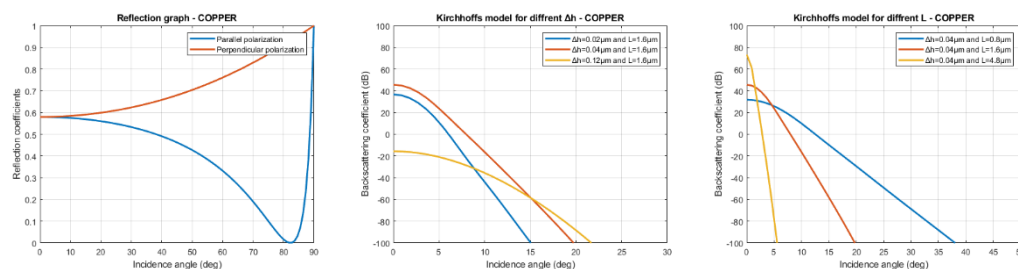

Figure 8. Angular dependence of: a) Fresnel reflection coefficients for copper material, b) Backscattering coefficient at L constant, c) Backscattering coefficient at Δh constant

3.4. IRON

The refractive index for iron is represented by the complex number 2.8954-3.9977i for a wavelength 532 nm. The calculation of Fresnel coefficients and the backscattering coefficient was done in the same way as for the previous materials. The results are shown in Figure 9a), 9b) and 9c).

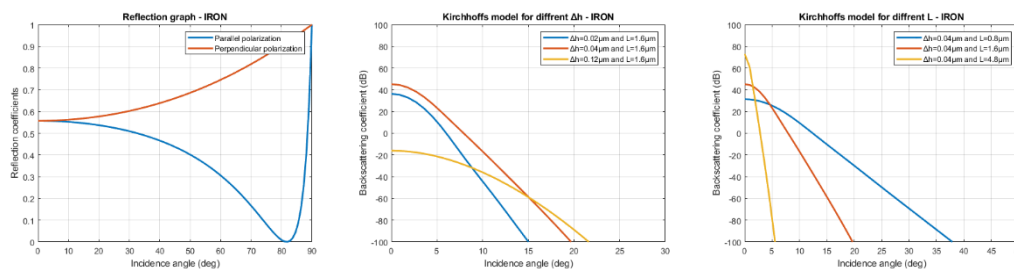

Figure 9. Angular dependence of: a) Fresnel reflection coefficients for iron, b) Backscattering coefficient at L constant, c) Backscattering coefficient at Δh constant

Copper and iron have similar reflection characteristics, as is the case with glass and plastic, and the graphs of reflection coefficients and graphs presenting backscattering coefficient are almost the same.

- For all tested materials and given values of roughness parameters, it was noticed that when L is constant and approximately $L \geq 3\lambda$, the scattering surface behaves as a mirror at small $\Delta h \approx \lambda/2$ and as Lambert surface at $\Delta h \geq 2\lambda$. In the second case, at constant $\Delta h \approx \lambda$, the scattering surface behaves as a mirror at $L \geq 10\lambda$ and as Lambert surface for $L \leq 1.5\lambda$.
- The maximum angle at which backscattering radiation can be detected for dielectrics from 5-30°, and for metals from 5-40°.
- Fresnel coefficients for metals have higher values than for dielectrics.
- The value of the backscattering coefficient is significantly higher for metallic materials compared to dielectric ones.
- It can be seen from the graphs that although these surfaces can be considered approximately smooth for the given parameters, the type of scattering and the range of angles at which backscattering occurs vary significantly when the roughness parameters are changing.

4. CONCLUSIONS

The main contribution in this paper was the research of the possibility of applying Kirchhoff's scalar approximation model for determination of backscattering radiation from different types of real materials.

The expression for determining the backscattering radiation coefficient in the Kirchhoff's model of scalar approximation contains an infinite sum of terms that affect the final value and it has been shown that it is sufficient to use the first 5 terms of that sum.

Surface roughness affects the quality of scanning and the same material has a different coefficient of backscattering radiation and the range of backscattering radiation angles depending on the degree of surface roughness. It has been shown that even for materials that are slightly rough and seemingly smooth, the range of angles at which they can be scanned strongly depends on the roughness parameters and they can behave more as a mirror or more as a Lambertian surface.

Using this model, backscattering radiation from dielectric and metal surfaces of different roughness parameters was compared. Based on the presented results, it can be noticed that backscattering coefficients in metals have higher values compared to dielectrics. When comparing materials with the same correlation length L but with different values of Δh , the intensity and angular distribution of backscattering radiation from metallic surfaces vary more significantly with the change of Δh . In a case of the materials with the same rms height Δh the glass surface show the smallest variation in a backscattering coefficients with correlation length comparing with other investigated materials.

Kirchhoff's model of scalar approximation can be used together with the measurement of backscattering radiations at different incidence angles. Based on the obtained modeling curves and measurement results the surface roughness parameters for a certain material can be estimated. This means that the roughness parameters can be estimated from measuring the intensity of the backscattered radiation from the surface at different angles, and using a theoretical scattering model for that type of surface.

The presented parameters of surface roughness can be used when creating a scanning plan. Based on the presented graph types, the range of incident radiation angles for which the backscattering coefficient is optimal can be predicted.

This work was financially supported by the Ministry of Education, Science and Technological Development of the Republic of Serbia (Grant No. 451-03-68/2020-14/200026).

LITERATURE

- [1] J. B. Campbell, and R. H. Wynne, *Introduction to Remote Sensing*, New York, USA: The Guilford Press, 2011.
- [2] T. Woldai, "Electromagnetic energy and remote sensing, " in *Principles of Remote Sensing*, 3rd ed., vol. 3. N. Kerle, L. L. F. Janssen, G. C. Huurneman, Ed. Enschede: The International Institute for Geo-Information Science and Earth Observation (ITC), 2004, pp. 29-43.
- [3] W. G. Rees, *Physical Principles of Remote Sensing*, Cambridge: Cambridge University Press, 2012.
- [4] S. Schröder, A. Duparré, L. Coriand, A. Tünnermann, D.H. Penalver, and J.E. Harvey, "Modeling of light scattering in different regimes of surface roughness," *Optics express*, vol. 19(10), pp. 9820-9835, May 2011.
- [5] J. Caron, L. Jacques, and C. Andraud, "Scalar Kirchhoff's model for light scattering from dielectric random rough surfaces," *Optics Communications*, vol. 207, pp. 17-28, June 2002.
- [6] Y. S. Kim, "4 to 18 GHz Rader Backscatter Model of First-Year Sea Ice," *Korean Journal of Remote Sensing*, vol. 3.2, pp. 89-102, 1987.
- [7] L. Sadowski, and T. G. Mathia, "The metrology of ground concrete surfaces morphology with 3d laser scanner," *Management and Production Engineering Review*, vol. 6(2), pp. 40-44, June 2015.
- [8] J.M. Bennett, and L. Mattsson, *Introduction to Surface Roughness and Scattering*, Washington, USA: Optical Society of America, 1999.
- [9] H. Ragheb, and E. R. Hancock, "The modified Beckmann Kirchhoff scattering theory for rough surface analysis," *Pattern Recognition*, vol. 40(7), pp. 2004-2020, July 2007.
- [10] P. Beckmann, and A. Spizzichino, *The Scattering of Electromagnetic Waves from Rough Surfaces*, New York, USA: Pergamon, 1963.
- [11] F. Ticconi, L. Pulvirenti and N. Pierdicca, "Models for scattering from rough surfaces," in *Electromagnetic Waves*, vol. 10. V. Zhurbenko, Ed. Rijeka, Croatia: InTech, 2011, pp. 203-226.
- [12] K. Tan, X. Cheng, and X. Cheng, "Modeling hemispherical reflectance for natural surfaces based on terrestrial laser scanning backscattered intensity data," *Optics Express*, vol. 24(20), pp. 22971-22988, 2016.
- [13] K. Tan, W. Zhang, F. Shen, and X. Cheng, "Investigation of TLS Intensity Data and Distance Measurement Errors from Target Specular Reflections," *Remote Sensing*, vol. 10(7), pp. 1077-1091, 2018.
- [14] N. C. Bruce, and J. C. Dainty, "Multiple Scattering from Random Rough Surfaces Using the Kirchhoff Approximation," *Journal of Modern Optics*, vol. 38(3), pp. 579-590, 1991.



Mladen Amović, University of Banja Luka, mladen.amovic@aggf.unibl.org

Ivana Janković, University of Banja Luka, ivana.jankovic@aggf.unibl.org

MONITORING OF SECURITY OF AGRICULTURAL CROPS WITH MINERAL MATERIALS BY REMOTE DETECTION

Abstract

The need to produce organic food and increase yields plays a significant role in the planning of agricultural production and the economy of the state in general. Monitoring and modeling of all stages of production implies the establishment of smart agriculture concepts based on the use of remote sensing results. This work procedure implies abandoning the classic homogenization in the approach to the cultivation of agricultural land and provides the possibility of anticipating problems and timely action, which should provide an increase in yield with environmental production conditions.

Keywords: remote sensing, multispectral sensors, smart agriculture.

МОНИТОРИНГ ОБЕЗБИЈЕЋЕНОСТИ ПОЉОПРИВРЕДНИХ УСЈЕВА МИНЕРАЛНИМ МАТЕРИЈАМА ДАЉИНСКОМ ДЕТЕКЦИЈОМ

Сажетак

Потреба за производњом органске хране и повећање приноса игра значајну улогу у планирању пољопривредне производње и економији државе уопште. Праћење и моделовање свих фаза производње подразумијева успостављање концепата паметне пољопривреде која се темељи на употреби резултата даљинске детекције. Овај поступак рада подразумијева напуштање класичне хомогенизације у приступу обради пољопривредних површина и пружа могућност предвиђања проблема и правовременог дјеловања што треба да обезбиједи повећање приноса уз еколошке услове производње.

Кључне ријечи: даљинска детекција, мултиспектрални сензори, паметна пољопривреда.

1. INTRODUCTION

Remote sensing is a method of measuring the properties of objects based on the intensity of wavelengths through systems that are not in direct physical contact with a phenomenon or object. Remote sensing systems give a continuous and consistent view of the Earth, providing information that can help ensure sustainable development. This is especially important in the modernization of agricultural production and the establishment of smart agriculture concepts.

The special significance of the application of remote sensing in the field of agriculture is reflected in the spectrum of electromagnetic (EM) bands whose wavelengths are absorbed by the Earth's atmosphere. Gathering information of a large number of ranges is called multispectral or hyperspectral data ranges. When solar radiation reaches the Earth's surface, some of the energy is absorbed and the rest is reflected or transmitted through the surface material. The reflection of radiation of one type of cover varies at different wavelengths in the EM spectrum and represents the spectral signature.

Measuring soil health indicators (SHIs), particularly soil total nitrogen (TN), is an important and challenging task that affects farmers' decisions on timing, placement, and quantity of fertilizers applied in farms [1]. There are several studies in which plant biomass is estimated from spectral and structural data, while nitrogen concentration is determined only from spectral characteristics [2]. Nitrogen is negatively associated with dry biomass and can be determined from crop height. Adequate nitrogen (N) supply is essential for healthy crop growth. With the advent of cheap drones (UAVs), several authors have offered solutions for accurate tools and remote sensing methods for determining nitrogen concentration based on multispectral aerial photographs [3]. One of the most commonly used methods is based on the determination of reflection elements in the visible and near-infrared (NIR) spectrum using hyperspectral sensors [4, 5]. Adequate supply of nitrogen (N) is mandatory for healthy crop growth, but negative consequences are known due to the lack of N concentration on the environment [5]. According to Guerif et al., Nitrogen concentration is determined by variables such as leaf area index (LAI) and chlorophyll content (Cab). Precision is achieved when previous information on the distribution of variables is used and when LAI is multiplied by Cab to obtain chlorophyll content, which is very suitable for quantification of nitrogen content [6].

The aim of the research is to obtain a unique model based on multi-year surveys of wheat crops, at precisely defined time intervals under the same conditions, which will provide sufficient quality information on the concentration of nitrogen and phosphorus in the plant stem based on spectral signatures. This leads to a transformation towards the concepts of organic agriculture, where on the basis of these results the treatment is carried out only in those zones where the concentration values of these minerals are critical. Those zones are given as digital maps. The paper presents the results of a scientific project funded by the Ministry of Scientific and Technological Development, Higher Education and Information Society, project number 19.032 / 961-133 / 19.

2. SMART AGRICULTURE BASED ON REMOTE SENSING PRINCIPLES

One of the most important benefits of using platforms based on the concepts of photogrammetry and remote sensing is the detection and monitoring of crops, i.e. crop conditions. Most global food stocks depend on the cultivation of several crops produced during the season, including corn, wheat, soybeans and rice. In recent years, a number of government agencies around the world have used satellite remote sensing to monitor and quantify these crops, as well as estimate yields. Remote sensing techniques are widely used in agriculture. The use of remote sensing is necessary, as agricultural activities face special problems that are not common to other economic sectors. First, agricultural production follows strong seasonal patterns associated with crop biological cycles. Production depends on the physical landscape, as well as on the climate and agricultural practices. These parameters vary highly with changes in time and space. Production may change in a short period of time, due to unfavorable weather conditions, so monitoring of crops must be timely. Remote detection can significantly contribute to the timeliness and accuracy of the agricultural sector, as it is suitable for collecting information over large areas, with high temporal resolution. The contribution of remote sensing in the agricultural sector has been discussed in the work of Clement Atzberger [7].

There are research results that have involved the use of satellite platforms such as satellite missions Sentinel, Landsat, Modis in tracking crops in macro-locations with a lower level of sensitivity of the treated area. With the greater use of unmanned aerial vehicles and monochrome sensors that have

the ability to collect data in the invisible part of the spectrum, it is possible to provide more accurate data on the state of land and crops at micro-locations. Table 1 shows the ranges of all wavelengths used in remote sensing.

Table 1. Wavelengths of electromagnetic spectra in remote sensing

Area		Wavelength	Frequency
Ultraviolet		100Å ~ 0.4µm	750 ~ 3000 THz
Visible		0.4µm ~ 0.7 µm	430 ~ 750 THz
Infrared	Near infrared	0.7 ~ 1.3 µm	230 ~ 430 THz
	Short wave infrared	1.3 ~ 3 µm	100 ~ 230 THz
	Intermediate infrared	3 ~ 8 µm	38 ~ 100 THz
	Thermal infrared	8 ~ 14 µm	22 ~ 38 THz
	Far infrared	14 µm ~ 1 mm	0.3 ~ 22 THz
Radio wave	Submillimeter		0.1 mm ~ 1 mm 3 ~ 3 THz
	Micro wave	Milimeter (EHF)	1 ~ 10 mm 30 ~ 300 MHz
		Centimeter (SHF)	1 ~ 10 cm 3 ~ 30 GHz
		Decimeter (UHF)	0.1 ~ 1 m 0.3 ~ 3 GHz
	Very short wave (VHF)		1 ~ 10 m 30 ~ 300 MHz
	Short wave (HF)		10 ~ 100 m 3 ~ 30 MHz
	Medium wave (MF)		0.1 ~ 1 km 0.3 ~ 3 MHz
	Long wave (LF)		1 ~ 10 km 30 ~ 300 KHz
Very long wave (VLF)		10 ~ 100 km 3 ~ 30 KHz	

The essential principle of monitoring crops is with the help of various vegetation indices, which are formed by various combinations of wavelengths of the corresponding spectrum. In addition to using visible light, remote detection also uses invisible light (infrared), which allows us to detect changes before they are noticed visually. To understand the application of vegetation indices (VI), changes in leaf-level plants must first be understood. It is these findings that have contributed to the application of remote sensing in the field of agriculture. As the authors in their study [7] state, leaves contain chlorophyll a and b as essential pigments for the conversion of light into chemical energy. The amount of solar radiation absorbed from the leaves is a function of the photosynthetic content of the pigment. Therefore, chlorophyll may directly affect photosynthetic potential and production [7]. VI, the indices used in remote sensing, are based on changes in the amount of chlorophyll. With the growth of the culture, the content of chlorophyll also increases, and based on that, the values of VI change. In other words, chlorophylls absorb blue and red in large quantities, and reflect green, and therefore are represented by green, and VIs represent reflected, absorbed and transmitted light. The beginnings of remote sensing in this area date back to the early 1970s, at the initiative of NASA. An experiment called Crop Identification Technology Assessment for Remote Sensing (CITARS) was started in 1973 to quantify crop identification with several automated classifications. An attempt was made to identify wheat yields for large regions during 1974-1977. Data from the Landsat 1 platform were then used. Later, a six-year program called Agriculture and Resource Inventory Survey Through Aerospace Remote Sensing (AGRISTARS) began in 1988. Since then, many experiments and studies have begun across Europe and the world. Today, remote sensing is an integrated part of the U.S. Department of Agriculture (Remote Sensing Applications in Agriculture at the USDA National Agricultural Statistics Service).

Also, one of the most famous programs in Europe is Monitoring Agriculture through Remote Sensing (MARS). The MARS project has developed Rapid Crop Monitoring for the Crop Growth and Monitoring System (CGMS), which incorporates crop simulation models, agrometeorological models and real-time data for yield estimation and evaluation. Another program for the classification of cultures in Europe is the Coordination of Information on the Environment (CORINE). Corine Land Cover (CLC) was initiated in 1985. There have been four updates since then, in 2000, 2006, 2012 and the last in 2018. It consists of 44 classes that cover the Earth's surface. The CLC minimum mapping size is 25 ha for surface elements and 100 m for linear elements. Various sensors and platforms were used to classify surfaces: Landsat 5, 7, Spot 4, 5, IRS P6 LISS and RapidEye [9]. Copernicus is the European Union's Earth observation programme. It offers information services that draw from satellite Earth Observation and in-situ (non-space) data. In the domain of agriculture, EU policies aim to foster the development of practices that preserve the environment and sustainable productivity. Agriculture is probably the most promising market in terms of the impact of

Copernicus, especially through precision farming. Indeed, Copernicus helps assessing agricultural land use and trends, crop conditions, yield forecasts, farm management recording and irrigation management. The domains of application of Copernicus also include seasonal mapping of cultivated areas, water management and drought monitoring, as well as subsidy controls.

As part of this research, based on accurate sowing plan data, for the time period of one sowing season, Sequoia sensors (Parrot Disco Pro AG sensor) and composite Normalized Difference Vegetation Index (NDVI) first determine the phenophases of monitored crops (wheat) to identify the beginning and end of the season for individual culture. During the sowing season, the development of plants was monitored through phenophases with plant inventory by making appropriate digital terrain models in order to identify changes and crop growth with appropriate differences between models. The state of phosphorus and nitrogen was monitored by creating indexed maps, on the basis of which the treatment zones were defined.

2.1. RELATED WORKS

Satellite missions and the Advanced Very High Resolution Radiometer (AVHRR) are products globally [10]. Crop characteristics can be quite different, for the same crops. Each crop has a special phenology, ie. special phenophases. Based on the follow-up of phenology, special cultures can be classified. The problem arises when classifying crops with similar phenologies, such as corn and soybeans, or corn and sunflowers, such as In addition to remote sensing, ancillary products such as seeding structures and high-resolution images, such as images taken by drones, must be used. Another problem is mixing crops with natural vegetation, grass or forests. In a study [10], the authors classified crops globally using multispectral imaging bands, the Normalized Difference Vegetation Index (NDVI), and thermal bands. Samples from 39 years were used. The results show a better classification for soybeans and maize than for other crops. High-resolution temporal monitoring of crops further improves the monitoring of phenology and classification possibilities. One of the possible platforms that can be used for these purposes is the Landsat platform with 30 m spatial resolution and 16-day temporal resolution.

On the other hand, monitoring crops in larger areas using LANDSAT requires a large number of cloud-free images to perform manual interpretation [11]. AVHRR and MODIS are imposed as two possible solutions. There are various studies based on vegetation indices (VI) with AVHRR [12, 13, 14]. However, these studies have been applied more globally than locally, due to the spatial resolution of 1 km to 8 km. Then there can be a problem of mixed pixels and it can happen that the monitored regions are not homogeneous, which is why the results are not reliable, ie. phenological indicators are unreliable [15, 16]. MODIS sensor on the Terra platform is satisfactory solution for large area temporal crop monitoring. This sensor provides spatial resolution of 250 m and the temporal resolution that is daily for territories above 30 degrees latitude [10]. Due to this resolution, larger areas must be monitored again, but not as in the case of AVHRR. MODIS also has better image quality than AVHRR due to radiometric resolution (12 bits) and improved geometric registration and atmospheric corrections [17, 18, 19].

One of the more interesting initiatives that incorporates remote crop detection and monitoring is the Hungarian Crop Monitoring and Production Forecast Program (CROPMON) [20]. CROPMON was operational from 1997 to 2003. CROPMON is a direct collaboration of the Hungarian Ministry of Agriculture and Remote Sensing (FÖMI Remote Sensing). It was used to estimate and monitor yields and monitor droughts and floods. It was an information system that made detailed maps based on recordings and ground truth data and estimated yields using an estimation model. CROPMON has collaborated with the Land Parcel Identification System, Drought monitoring system and Flood monitoring applications. Comparing the data obtained with Cropmon with the data from the Statistical Office, a difference of 0.8% to 3.7% in the yield estimate for the whole of Hungary was shown. In the Cropmon model, LANDSAT, AVHRR, Spot and IRS satellite images were used. This is a proof of good cooperation between remote sensing and crop monitoring at the level of one country. In a study [21], the authors estimated maize and soybean yields in the United States (Iowa and Illinois) using MODIS 8-day composite bands 1 and 2 (MOD09Q1 product). Based on these bands, they get NDVI for a composite period of 8 days. They also use MODIS product 11A2, the temperature of the earth's surface. Multiple regression was performed with these parameters after classification. The results obtained by the authors were strongly correlated with data from the US Department of Agriculture. The number of parameters that affect yields that can be used to evaluate inventoried individuals is diverse. The authors in [22] in addition to NDVI with AVHRR use air temperature, soil moisture and rainfall as indicators of yield for a sample of 19 years. They also state that these parameters are not linearly related to yield and use nonlinear regression (Quasi-Newton method) for estimation. It can be concluded that by increasing the monitored parameters and

increasing the monitored years, the relationship between yields becomes nonlinear and multiple linear regressions cannot be used.

2.2. STUDY AREA

The research was conducted in the area of the City of Banja Luka, the site of the Agricultural School of Banja Luka. The site has been treated for many years so there is a history of sowing with all the information about the treatment of crops and land. Therefore, it was convenient to perform a comparative analysis of land for which there is a sufficient amount of historical information.

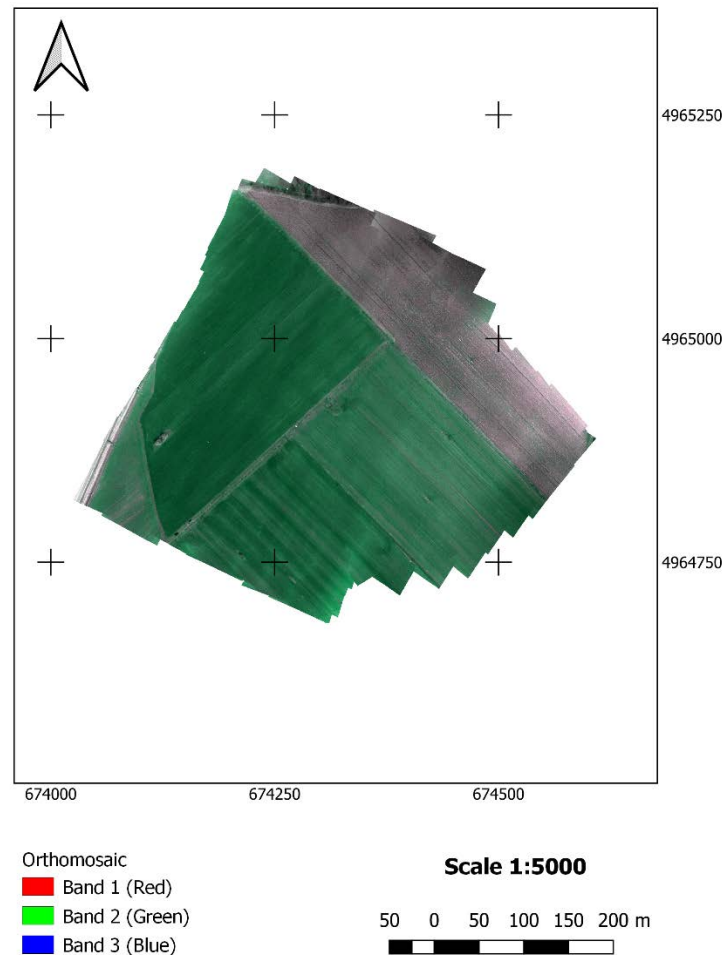

Figure 1. Study area

2.3. MULTISPECTRAL SENSOR USED FOR CROP DETECTION

Data acquisition was performed using a Parrot Dico Pro AG and DJI Phantom 4 Pro drone using a Sequoia multispectral sensor. It is intended for use in agricultural production. It is designed according to three main criteria: exceptional precision, minimum size and weight, and ease of use. The Sequoia sensor is designed to suit all types of drones, those with fixed wings and helicopters.

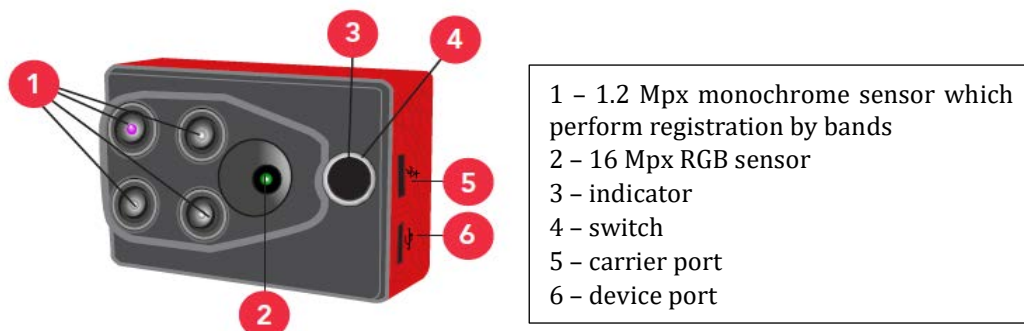

Figure 2. Sequoia sensor characteristics

It can be used to obtain images of agricultural fields in several spectral bands that measure the state of vegetation: Green (550 nm wavelength, 40 nm range), red (660 nm wavelength, 40 nm range), Red Edge (735 nm wavelength, width band 10 nm) and near infrared (790 nm wavelength, 40 nm band). Images recorded with this sensor can then be analyzed using various software. They will be used to create index maps (such as NDVI, NDRE) and to make recommendations regarding fertilization, which are indicated through the nitrogen content, as the main mineral that affects the development of the plant. Nitrogen content can be determined using near infrared (780–800 nm) and either green (540–560 nm) or red-edge (730–750 nm) spectral bands [23]. Figure 2 shows the Sequoia sensor with its characteristics. In addition to the data obtained with the multispectral camera, the data of the European Space Agency for Sentinel 2 satellite missions are used.

2.4. METODOLOGY

Remote sensing uses data from satellite sensors that measure the wavelengths of light absorbed and reflected by green plants in order to study phenology. Certain pigments in the plant strongly absorb red light wavelengths. On the other hand, the reflection of infrared light is great, which is invisible to the human eye. As the structure of the plant changes from the beginning to the end of the season, these reflections also change. Many remote sensing sensors measure and record these reflections. Vegetation index is a numerical indicator that defines greenery - relative density and health of vegetation. Indices are obtained by simple mathematical operations and by combining appropriate bands. One of the best known and certainly most used is the Normalized Difference Vegetation Index (NDVI). In theory NDVI values range from -1 to +1, in practice this limit is a bit narrower, so the upper limit goes to 0.8. Bare areas of rock, sand, or snow typically have very low NDVI values of 0.1 or less. Rare vegetation has higher values from 0.2 to 0.5, as well as crops in gradual growth. Areas under dense vegetation, forests or agricultural crops have high NDVI values in their maximum vegetation period. By transforming raw satellite data into NDVI values, researchers can create images and other products to generate rough measurements of vegetation types, quantities, or conditions on the Earth's physical surface. NDVI is extremely useful for global monitoring of vegetation because it can compensate for the angle of view of the sensor on the ground or the influence of the sun. NDVI values can be monitored over time to establish normal conditions in which vegetation grows for specific regions. Determining these values by phenophases can serve as a kind of template for future monitoring of crops. It was first used by Rose [24]. NDVI is calculated as follows:

$$\text{NDVI} = (\text{NIR} - \text{RED}) / (\text{NIR} + \text{RED}) \quad (1)$$

NIR- Near-Infrared reflection, RED- RED reflection

By generating time series, NDVI provides a temporal curve that summarizes the various stages that green vegetation goes through throughout the season. Such a curve can be analyzed in order to define key phenological events, such as the beginning and end of the growing season, the peak season and the end of the season. Different phenological scales are used to identify the phenological phases of plants, but two are the most commonly used: Feekes [25, 26, 27], and the BBCH scale [28]. These phenological scales describe the basic stages of growth and development of small grains such as: germination, germination, budding, wilting, flowering and pollination, as well as stages of grain maturation. Phenological analysis during the life cycle of plants reveals periodic morphological changes of plants, which in addition to identifying the phenological phase indicates the necessary and timely agro-technical intervention in the crop [29]. The vegetative phase lasts differently depending on the time of sowing and genotype, as well as on the sequential appearance of leaves on the primary tree (phyllochron), but also on the differentiation of the flower, which is conditioned by the process of vernalization and photoperiod. Among other things, phyllochrone depends on temperature [30], water [31], and available nitrogen content [32]. The reproductive phase of ontogenesis implies the differentiation of reproductive organs (flower, inflorescence, fruit). This (Biologische Bundesanstalt, Bundessortenamt and Chemische Industrie) with identification keys for small grains. In this scale, 10 basic stages of growth were identified, but for the purposes of the research, the following were monitored (Figure 3):

- Main growth phase 1 (leaf development) - covers the period marked with BBCH 10–19, which includes the growth period from the first open leaf to n number of open leaves (expected 3 leaves) of wheat. Depending on the sowing date, it will be possible to record wheat plants in the autumn with a multispectral camera at the end of November, and depending on the environmental conditions, it is possible that the wheat will enter the winter dormancy phase after that.
- Main growth phase 2 (budding) - includes the period marked with BBCH 20–29, ie the period until the end of the biological budding process. Depending on the time of sowing

and average temperatures in the autumn period, it is possible that wheat will start with autumn harvesting, this phase will last until the spring of next year and will end in early April. It is potentially possible to record plants with a multispectral camera outdoors 2 times (December if there is no snow cover and March).

- Main growth phase 3 (tree elongation) - covers the period marked with BBCH 30-39, covers the period of growth and development from the beginning of tree growth to the stage when the flagellum leaf is fully developed and the ligula is slightly visible. The mentioned phase will take place during April, one recording with a multispectral camera is necessary.
- Main growth phase 4 (immediately before grading) - includes the period marked with BBCH 41–49, means the period of elongation of the flagellum leaf arm to the visible axis phase (for axial forms). This phase is expected to be relatively short.
- Main growth phase 5 (grading) - covers the period marked with BBCH 51–99, ie the period from the beginning of grading to the moment when the inflorescence is fully visible. This phase takes place in the first half of May, one recording with a multispectral camera is necessary.
- Main growth phase 6 (flowering) - covers the period identified by BBCH 61–69, and means the period from the beginning of flowering to the end of flowering. This phase takes place soon after the previous phase, another recording with a multispectral camera at the end of May is recommended;
- Main growth phase 7 (fruit development) - includes the period marked with BBCH 71–77, ie the period from the water state of the grain to the late milk maturity of the grain. This phase is expected to last from the end of May to the middle of June, and one multispectral camera recording will be required;
- Main growth phase 8 (maturation) - covers the period from BBCH 83–89, refers to the period from the early doughy phase to full maturity. At this stage, the fruit is still being poured, which is why it is interesting to perform another recording with a multispectral camera of wheat plants in the second half of June.

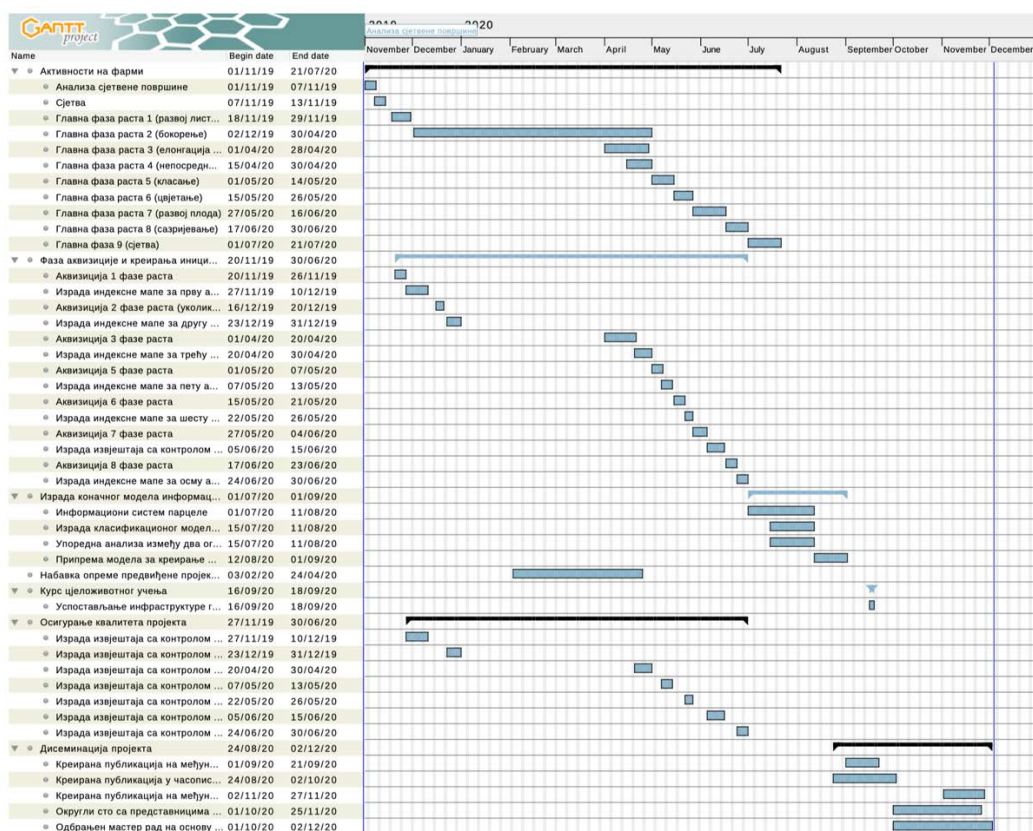

Figure 3. Ganttgram of the project

In this study, we used DJI Phantom 4 Pro and Parrot Disco Pro AG. Missions were performed at 30 m altitude. The RGB image resolution was 1.56×1.56 pixel and capture was set to 80% side and 80% front image overlap. Image acquisition was conducted on the same dates as ground fieldwork

when the biomass collection is conducted. The flight plans for each field were made in the Pix4D software suite "Pix4Dcapture" app and were processed in Pix4D Fields app. Using this software in every point is conducted: the chlorophyll index rededge (CI_RE), the normalized difference vegetation index (NDRE), normalized difference vegetation index (NDVI). The last one is used for purpose of crop monitoring and biophysical estimation. Chlorophyll estimation have been found to be related to plant nitrogen content as the photosynthetic enzyme, consuming the largest proportion of nitrogen in leaves [10]. Chlorophyll reflects green and NIR radiation and absorbs more than 70% of blue and red radiation [10]. So this bands will be used for the estimation algorithm for the nitrogen detection. An important step in producing a high-quality final image is radiometric calibration considering the sensor influence and scene illumination of the UAV flight. Prior to each flight over a field, the sensor was calibrated to take a minimum of five white reference images for each band. Nitrogen concentration weight is calculated using this method $NW = LNC \times Wd$, where NW is nitrogen weight (g/m²), LNC is leaf nitrogen content (g/m²) and Wd is dry biomass weight (g/m²).

For the estimation of the Nitrogen content there is established the relationship between nitrogen and chlorophyll content. Relationship between N and leaf level contents (Cab) are robust. According to numerous researchs we used definition that there is confirmed strong relationship between leaf chlorophyll content per unit soil area. In the analysis we use Wd to represent dry weight of the aerial shoots in t.ha⁻¹. According to the planed acquisition of data and estimation of the Nitrogen level in the laboratory we conducted linear relationship between Cab and Nitrogen level. It is represented with correlation as $N = a \text{ Cab} + b$. Coefficient a and b are linear regresion coeficients obtained with the use of the parameters of N concentration from laboratory for the sampled area. Changes between two acquisitions on the ΔN make assumptions about the efficiency of the fertiliser, which can however be estimated from the absorption deficit and the amounts. On this basis we create recommendation map which will reflect the variability observed by remote sensing. For proposed model we dervided indicies to vector format so we can use them in the analysis. LAI and ΔN values are derived from the remote sensing acquisitions and compared to the values got from the laboratory. Laboratory check of the samples is quality assurance of the proposed model and verification method.

3. RESEARCH RESULTS

The research was realized according to the phases defined in the previous chapter. In all phases, a comparative analysis was performed by remote sensing and laboratory research. Sobred is a medium early variety. The plant is on average about 80 cm tall. This very high-yielding variety of wheat has a very good tolerance to lodging and diseases such as spotting, rust and fusarium head blight. The sowing norm is 400-500 germinating grains per m².

Graindior is a variety with an excellent ratio of yield and quality. It is a medium-early variety in terms of vegetation. The average height of the plant is about 92 cm. Resistance to powdery mildew and Septorium tritica is average, to Fusarium very good, and to leaf and yellow rust excellent. The sowing rate is 380 to 420 germinating grains per m².

Sobred and Grandior wheat crops were sown in the experimental field. In each phenophase, crop recording was performed using a multispectral sensor and field sampling of the aboveground part of the plant and the leaf blade of the apical leaf for which nitrogen concentrations were determined in the laboratory (Table 2).

Table 2. Nitrogen content (N) in wheat samples 2019/2020

Nmb	Sort	Analyzed organs	$\bar{X} \pm S_{\bar{x}}$
1	Sobred	Overhead part	21,19 ± 1,05
		Leaf blade of apical leaf	27,69 ± 1,67
2	Grandior	Overhead part	26,61 ± 1,19
		Leaf blade of apical leaf	35,31 ± 2,24

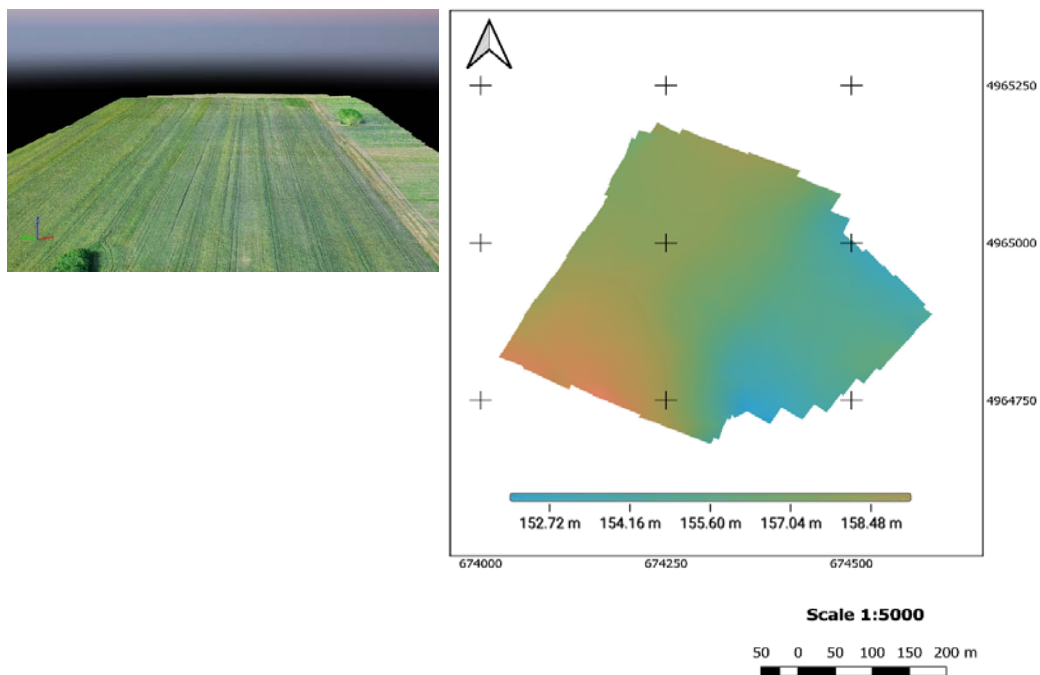

Figure 4. Digital elevation model

Field measurements and processing of the collected images to determine the concentrations of nitrogen were performed within the software Pix4D Capture, Pix4D Mapper and Pix4Dfields. In each phase of monitoring, an orthophoto area and a digital elevation model were created, based on which plant growth is measured per pixel (Figure 4).

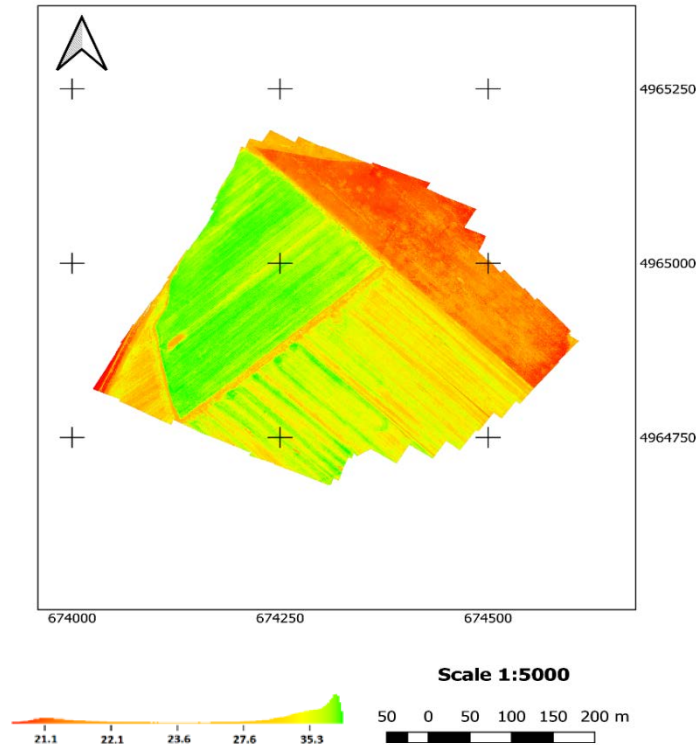

Figure 5. Concentration of the Nitrogen in the leaves conducted through algorithm using UAV multispectral images

An index map was created to monitor the surface condition of the plant. Also for the purpose of inventory, a point cloud obtained by the method of structures from motion was used (Figure 5). Based on the results shown in the Table 2, the distribution of the NDRE index on the observed plot

can be observed. In most cases shown of Figure 5, values between 20 and 24 correspond to areas with sparse vegetation; moderate vegetation tends to vary between 24 and 30; anything above 30 indicates the highest possible density of green leaves and plants with highest N concentration.

To conduct estimation of nitrogen in leaves it was used regression model created by the use of the five band reflectances results (green, blue and NDRE values per pixel), plant height, topographic parameters and laboratory conducted values of nitrogen in specific points. Proportion is used to calibrate the dataset using exact values and 4 samples were used for model validation. In table 3 is given statistics for calibration model.

Table 3. Statistics parameters for the calibration of the UAV estimated nitrogen concentration

Date	Model	R ²	RMSE (g/m ²)
25.4.2020.	UAV estimation	0.91	26.4

4. DISCUSSION

Results presented in the research gives quality model for the estimation of the Nitrogen concentration in the plant leaves. Model can be used to predict the changes of the N concentrations according to the phase of the plant development and to give farmers instructions how and with which quantity to perform fertilization in which area.

Proposed method obtained quantitative benefits:

Saving time on field analyzes: one of the main benefits is the reduction in the time required by farmers to spend each week during the crop development season on the monitoring and sampling determining the signs of plant disease. Through this way of monitoring plants, there is a possibility of research and possible reduction of plant treatment.

Less use of chemical products: data from multispectral sensors can help to prolong the interval between fertilizers if the crops show good condition. Diseases that are detected by recording with a multispectral camera at the beginning of the season can be affected during the season, by treating them with appropriate agro-technical measures on the detected hotspots. The biggest problems are reflected in diseases during the main growing season. With appropriate monitoring, it is possible to reduce the use of chemicals, in the sense that it is not necessary to use the same amount of material in all parts of the crop. Research on potato crops has shown that about 50% of the field can withstand reduced spraying.

Increasing yields: It is believed that more efficient use of input data, fields will have higher yields and this is one of the main goals of the project. As the data are added, a higher yield is assumed compared to that obtained by using classical agro-technical measures. If the technical maturity of the wider community became higher and if data were collected over several years, the potential increase would be significant.

Optimum crop collection: It is possible to give recommendations to farmers on the optimal harvest time to get the largest product from the field. By using defined input data, it is possible to obtain a precise harvest date.

Yield quality: Better knowledge of crop conditions will lead to increased yield quality which will be of greater value to the processing industry. There are many elements that affect the physical factors of the product, which can be influenced with timely and comprehensive information. There is a clear economic benefit here.

Water: As a condition for the development of the method, one field can be recorded at the beginning of the growing season, and the results act as a reference for other fields. Water level and soil moisture vary considerably from field to field, but the farmer must understand the relationship between the reference field and other areas on which the crop is sown.

Environmental impact: Today, many politicians and citizens are concerned about the increased use of chemicals on agricultural land and the possible impact on health due to the presence of crops and drinking water. This leads to new legislation controlling the use of pesticides, fungicides and fertilizers. Fertilizers are usually applied several times during the development of the plant. Currently, farmers treat fields as homogeneous entities although fields are usually very diverse with different needs for chemicals in different field locations. Knowledge of field performance during previous years, together with measurements taken from satellite images and drones, will enable the production of maps with different data and variables. This will reduce the amount of fertilizer applied, which will be more adapted to the needs of the plants. More precise application leads to much better uptake and greatly reduced excess in the soil. As a result, the amount of manure released into the environment and surface water sources is greatly reduced.

- Farmer awareness: the use of these concepts will certainly give a better overview of agricultural fields and operations, and raise farmers' awareness of their farm characteristics, which can lead to improved decisions in the long run.
- Digitization: has the potential to raise awareness of digital tools available to farmers and generally supports digitalisation in the agricultural sector, thus acting as a catalyst for the use of digital tools. Many organizations evaluate digital tools and instruments that will bring huge economic benefits to farmers and the agricultural sector in general.
- Contactless field monitoring (remote monitoring): In large agricultural plants and farms there is an increase in arable land, which is why additional workers must be hired for cultivation. Therefore, the areas that need to be analyzed and treated are larger. As a result, farmers risk spending more time in the fields, whether it is reconnaissance, spraying or other field operations. In general, farmers with a total size of 400-600 ha, have very scattered fields. By using remote sensing, it is possible to reduce the need for a physical tour of the terrain, as well as by determining the zones that need to be treated, which automatically leads to a reduction in the need for additional manpower.
- Knowledge of field history: Many farmers can benefit from archived data. They do not know the potential of some of their fields for growing crops, because they have to comply with the regulations regarding crop rotation. In addition, some farmers rent fields and do not know the specific characteristics of the fields. Through the use of this technology, it is possible to provide information and data on the performance of fields in recent years, so that the farmer can make better decisions and actions in his fields. This in turn should lead to better production and a larger product.

5. CONCLUSION

Remote sensing observations in the visible and near infrared spectral domains allow mapping of leaf chlorophyll content. This gives key variables of crops for the terms of growth and health. According to this we can estimate nitrogen status for the specific moments of the growing season. This variables modeled from the remote sensing data, laboratory estimated contents used us for the creation of the model where was possible to get the content of the variable rate of the nitrogen in the plant for the fertilization purposes. According to this we can promote precise agriculture.

Through the project, this developed method, gave significant results in the field of obtaining timely information using several types of data. Combined data were provided through the Copernicus Sentinels program, multispectral cameras, weather conditions and field measurements (soil sampling). Thanks to the proposed model, users received accurate information on the state of yield, predictions, as well as measures of action and treatment of the plant.

Through this technology and defined methodology, it is possible to:

- Access to crop-level information
- Monitoring crop development through plant growth and health parameters
- Mapping of spatial variables at the crop level
- Improving the condition and development of crops
- Estimation of harvest date and yield during the season
- Reduction of losses in production and quality

LITERATURE

- [1] Hossen, M.A., Diwakar, P.K. & Ragi, S. Total nitrogen estimation in agricultural soils via aerial multispectral imaging and LIBS. *Sci Rep* 11, 12693 (2021). <https://doi.org/10.1038/s41598-021-90624-6>.
- [2] Tilly, N.; Bareth, G. Estimating Nitrogen from Structural Crop Traits at Field Scale—A Novel Approach Versus Spectral Vegetation Indices. *Remote Sens.* 2019, 11, 2066. <https://doi.org/10.3390/rs11172066>.
- [3] Colorado, J.D.; Cera-Bornacelli, N.; Caldas, J.S.; Petro, E.; Rebolledo, M.C.; Cuellar, D.; Calderon, F.; Mondragon, I.F.; Jaramillo-Botero, A. Estimation of Nitrogen in Rice Crops from UAV-Captured Images. *Remote Sens.* 2020, 12, 3396. <https://doi.org/10.3390/rs12203396>.
- [4] Sun, D.; Cen, H.; Weng, H.; Wan, L.; Abdalla, A.; El-Manawy, A.I.; Zhu, Y.; Zhao, N.; Fu, H.; Tang, J.; et al. Using hyperspectral analysis as a potential high throughput

- phenotyping tool in GWAS for protein content of rice quality. *Plant Methods* 2019, 15, 54.
- [5] Lu, Ning & Wang, Wenhui & Zhang, Qiaofeng & Li, Dong & Yao, Xia & Tian, Yongchao & Zhu, Yan & Cao, Qiang & Baret, Fred & Liu, Shouyang & Cheng, Tao. (2019). Estimation of Nitrogen Nutrition Status in Winter Wheat From Unmanned Aerial Vehicle Based Multi-Angular Multispectral Imagery. *Frontiers in Plant Science*. 10. 1601. 10.3389/fpls.2019.01601.
- [6] Martine Guerif, Vianney Houlès, Frédéric Baret. Remote sensing and detection of nitrogen status in crops. Application to precise nitrogen fertilization. 4. International Symposium on Intelligent Information Technology in Agriculture, Oct 2007, Beijing, China. 19 p. fhal-02824189f.
- [7] Atzberger, C.; *Advances in Remote Sensing of Agriculture: Context Description, Existing Operational Monitoring Systems and Major Information Needs*. Remote Sensing 2013.
- [8] Hatfield, J.L.; Gitelson, A.A.; Schepers, S.J.; Walthall, C.L. Application of Spectral Remote Sensing for Agronomic Decisions. *Agronomy Journal* 2008.
- [9] <https://land.copernicus.eu/pan-european/corine-land-cover>, April 2022.
- [10] Pittman, K.; Hansen, M.C.; Becker-Reshef, I.; Potapov, P.V.; Justice, C. Estimating Global Cropland Extent with Multi-year MODIS Data. *Remote Sensing* 2010.
- [11] Lobell, D.B.; Asner, G.P. Cropland distributions from temporal unmixing of MODIS data. *Remote Sensing of Environment* 2004.
- [12] Lloyd, D.; A phenological classification of terrestrial vegetation cover using shortwave vegetation index imagery. *International Journal of Remote Sensing* 1990.
- [13] Schwartz, M.D.; Reed, B.C.; White, M.A. Assessing satellite-derived start of season measures in the conterminous USA. *International Journal of Climatology* 2002.
- [14] Moulin, S.; Kergoat, L.; Viovy, N.; Dedieu, G.G. Global scale assessment of vegetation phenology using NOAA/AVHRR satellite measurements. *Journal of Climate* 1997.
- [15] Reed, B.C.; Brown, J.F.; VanderZee, D.; Loveland, T.R.; Merchant, J.W.; Ohlen, D.O. Measuring phenological variability from satellite imagery. *Journal of Vegetation Science* 1994.
- [16] Zhang, X.; Friedl, M.A.; Schaaf, C.B.; Strahler, A.H.; Hodges, J.C.F.; Gao, F.; Reed, B.C.; Huete, A.; Monitoring vegetation phenology using MODIS. *Remote Sensing of Environment* 2003.
- [17] Huete, A.; Didan, K.; Miura, T.; Rodriguez, E.P.; Gao, X.; Ferreira, L.G. Overview of the radiometric and biophysical performance of the MODIS vegetation indices. *Remote Sensing of Environment* 2002.
- [18] Vermote, E.F.; Salouas, N.Z.; Justice, C.O. Atmospheric correction of MODIS data in the visible to near infrared: First results. *Remote Sensing of Environment* 2002.
- [19] Wolfe, R.E.; Nishihama, M.; Fleig, A.J.; Kuyper, J.A.; Roy, D.P.; Storey, J.C.; Patt, F.S. Achieving sub-pixel geolocation accuracy in support of MODIS land science. *Remote Sensing of Environment* 2002.
- [20] Csornai, G.; Wirnhardt, Cs.; Suba, Zs.; Nador, G.; Tikasz, L.; Martinovich, L.; Kocsis, A.; Zelei, Gy.; Laszlo, I.; Bogner, E. CROPMON: Hungarian crop production forecast by remote sensing. ISPRS Archives XXXVI-8/W48 Workshop proceedings: Remote Sensing support to crop yield forecast and are estimation 2007.
- [21] Doraiswamy, P.C.; Akhmedov, B.; Beard, L.; Stern, A.; Mueller, R. Operational prediction of crop yields using MODIS data and products. ISPRS Archives XXXVI-8/W48 Workshop proceedings: Remote Sensing support to crop yield forecast and are estimation 2007.
- [22] Prasad, A.K.; Chai, L.; Singh, R.P.; Kafatos, M. Crop yield estimation model for Iowa using remote sensing and surface parameters. *International Journal of Applied Earth Observation and Geoinformation* 2006.
- [23] Schellmer, M.; Gitelson, A.; Schepers, J.; Ferguson, R.; Peng, Y.; Shanahan, J.; Rundquist, D. Remote estimation of nitrogen and chlorophyll contents in maize at leaf and canopy levels. *Int. J. Appl. Earth Obs. Geoinform.* 2013, 25, 47–54.
- [24] Rouse, J.W.; Haas, R.H.; Chell, J.A.; Deering, D.W. Monitoring vegetation systems in the Great Plains with ERTS. In 3rd ERTS Symposium, NASA SP351, 1973.
- [25] Large, E. G. (1954): Growth stages in cereals: Illustration of the Feeke's scale. *Pl. Path.* 3: 128-129.
- [26] Haun, J. R. (1973): Visual quantification of wheat development. *Agron. J.* 65: 116-119.

- [27] Zadoks, J. C., Chang, T.T., Konzak, C. F. (1974): A decimal code for the growth stages of cereals. *Weed Res.*, 14: 415-421.
- [28] Lancaster, P. D., Bleihlder, H., Van der Boom, T., Langeladdke, P., Stauss, R., Weber, E., Witzemberger, A. (1991): A uniform decimal code for growth stages of crops and weeds. *Ann. Appl. Biol.* 119: 561-601.
- [29] Кондић, Д. (2015): Житарице; морфо-физиологија, репродуктивна биологија, онтогенеза, биолошка контрола и моделирање продуктивности. Пољопривредни факултет Универзитета у Бањој Луци. ISBN 978-99938-93-5, стр. 227.
- [30] Rickman, R. W., Klepper, E.L. (1991): Tillering in wheat. In T. Hodges, ed. *Predicting crop phenology*, p. 73-83. Boca Raton, FL, USA, CRC Press.
- [31] Cutforth, H. W., Jame, Y. W., Jefferson, P. G. (1992): Effect of temperature, vernalisation and water stress on phyllochron and final main-stem number of HY320 and Neepawa spring wheats. *Can. J. Plant Sci.*, 72: 1141-1151.
- [32] Longnecker, N., Kirby, E. J. M, Robson, A. (1993): Leaf emergence, tiller growth, and apical development of nitrogen-deficient spring wheat. *Crop Sci.*, 33: 154-16



Danko Markovinović, University North, University center Varaždin, danko.markovinovic@unin.hr
Dorotea Lovrenčić, CUBUS doo, Varaždin, dorotea.lovrencic@gmail.com
Sanja Šamanović, University North, University center Varaždin, sanja.samanovic@unin.hr
Vlado Cetl, University North, University center Varaždin, vlado.cetl@unin.hr

3D LASER SCANNING FOR RECONSTRUCTION AND RENOVATION OF BUILDINGS

Abstract

Buildings and their infrastructure are one of the foundations of every civilized society for a normal and comfortable life. Since the lifespan of buildings also passes over time, they need to be maintained and after a certain time, renovation or reconstructed. Reconstruction and renovation of a building includes the performance of construction and other works for the purpose of its renovation. An important step in the reconstruction and renovation is the collection of geospatial data. 3D laser scanning is an advanced geomatic technology for collecting geospatial data for the purpose of analyzing geospatial information and creating the necessary technical basis for further design work.

Keywords: geomatics, 3D laser scanning, reconstruction, renovation, geospatial data

3D ЛАСЕРСКО СКЕНИРАЊЕ ЗА ПОТРЕБЕ РЕКОНСТРУКЦИЈЕ И САНАЦИЈЕ ГРАЂЕВИНЕ

Сажетак

Зграде и њихова инфраструктура један су од темеља сваког цивилизованог друштва за нормалан и удобан живот. Пошто и век трајања објеката пролази временом, потребно их је одржавати и после одређеног времена поправљати или реконструисати. Реконструкција и санација објекта обухвата извођење грађевинских и других радова у циљу његове рестаурације. Важан корак у реконструкцији и рехабилитацији је прикупљање геопросторних података. 3Д ласерско скенирање је напредна геоматска технологија за прикупљање геопросторних података у сврху анализе геопросторних информација и стварања неопходне техничке основе за даље пројектовање.

Кључне ријечи: геоматика, 3Д ласерско скенирање, реконструкција, реновирање, геопросторни подаци

1. INTRODUCTION

Managing business processes in construction is an extremely complex and demanding task or project [1]. In addition to professional, scientific and experiential assumptions, the project requires coordinated cooperation and communication of the entire project team and an interdisciplinary approach of technical professions in order to meet all project objectives [3]. The basic parts of planning each project are making a plan, defining the required level of detail to be built into the plan, identifying milestones in the project, preparing various detailed elements of the plan and using available tools to prepare and monitor the plan [13]. In order to overcome the organizational and technical complexity of the project, a big step forward in the last few years is the application of 3D geospatial and information technologies (IT). Advanced technologies accelerate the procedures and the realization of set goals. Building Information Modeling (BIM) and the creation of 3D building models is a modern approach to project design in construction, an excellent digital tool for improving, accuracy, and speed of project implementation [2]. Also, since each building has its own lifespan and after some time requires renovation or reconstruction, the 3D model allows you to define the status of damage, monitor the progress of damage, and greatly facilitate the remediation and reconstruction project. This approach to project preparation and implementation contributes to reducing the costs of project preparation and implementation [14].

2. RECONSTRUCTION AND REHABILITATION OF BUILDINGS

Reconstruction and rehabilitation of the building occupies a special part of business processes in civil construction. Given the daily needs of the market, reconstruction and rehabilitation are expanding rapidly in the construction industry. Reconstruction and rehabilitation procedures include reconnaissance of the building, planning of works and preparation of the project, collection of geospatial data, elaboration of project documentation, project execution, renovation and reuse of buildings [1]. Advanced geomatic technology in terms of digital collection of geospatial data enables efficient processing, analysis, and implementation to prepare and implement further project processes. Laser 3D scanning allows complete digital documentation of the building, outside and inside. Using this advanced technology is key to creating new approaches to civil construction business processes.

2.1. RECONSTRUCTION OF BUILDINGS

Reconstruction of a building means the renovation of an existing building or its entirety. It is actually the performance of construction and other works on an existing building that affect the fulfillment of basic requirements for that building or that change the compliance of that building with the location conditions in accordance with which it was built (extension, upgrade, removal of the outer part of the building, changes in the purpose of the building or technological process, etc.), ie the performance of construction and other works on the ruins of an existing building for the purpose of its renovation [8].

The most common interventions in the form of reconstruction are related to improving or changing the load-bearing structure of the building. Modern reconstruction is divided into exact (exact reconstruction (based on building documentation), analog reconstruction (based on comparison and determination of similarities with another example) and hypothetical reconstruction (based on the assumption of the shape of elements and parts of the building that no longer exists, and which will be rebuilt).

Project documentation for the reconstruction of the building should be performed in such a way as to achieve the ability of the building as a whole and each of its parts and elements, to withstand all planned activities, or retain important technical properties in accordance with regulations, norms and standards. The reconstruction project should contain all the necessary plans for the existing condition of the building and a presentation and description of all types of damage and the method of renovation [9], [10]. In this step, the great application of 3D technology is seen, which enables the digital view of the required documentation both in the point cloud and in the photography that the instrument takes at the required location.

2.2. RENOVATION OF BUILDINGS

Renovation of buildings, as one of the main elements of the organization of construction sites and construction, is a series of construction and other works on an existing facility in order to prepare the facility for the function intended for it, which does not change the original form and material and does not affect safety neighboring buildings, environment and traffic [8].

Renovation interventions on the building primarily depend on the degree of deterioration or neglect of the building, with the overall picture of the current state of the building having a decisive role in the choice of remedial interventions.

The renovation project is implemented according to the remediation project, using all positive previous experiences, appropriate remediation technology, and proven materials with which manufacturers attach precise technological instructions and give a certain guarantee.

Rehabilitation is required in case of: deterioration of the building due to environmental loads (freezing, moisture, corrosion, etc.), damage due to earthquakes, fire, shifting foundations, errors due to poor design and construction, material deterioration or conversion of the object due to a change in use or a change in budget procedures in the applicable standards.

Renovation phases are anamnesis (object data, damage identification and hypothesis of damage causes), diagnosis (field and laboratory tests), therapy (recommendation of renovation methods and materials, renovation design) and control (project audit, performance supervision and control performed, renovation and monitoring and management of the rehabilitated facility). The renovation project should also include all textual, computational and graphic attachments [4].

The study on the review and assessment of the existing condition of the structure is of paramount importance for the preparation of the renovation project and should include a recording of all structural damage, volume, intensity and causes of damage, testing of mechanical properties, deformation of the structure, quality, condition and degree of corrosion, condition of the structure and the proposed method of renovation [5].

In this step, the great application of 3D technology is seen, which enables the digital view of the required documentation both in the point cloud and in the photography that the instrument takes at the required location. Reconstruction and renovation occupy a special part of business processes in civil construction. Given the daily needs of the market, renovation and reconstruction is expanding rapidly in the civil construction industry. Reconstruction and renovation procedures include reconnaissance of the building, planning works and project preparation, collecting geospatial data, elaboration of project documentation, execution of the reconstruction project, and reuse. Advanced geomatic technology of digital geospatial data collection enables efficient processing, analysis, and implementation to prepare and implement further project processes.

Such is the case with the 3D laser scanner, which enables digital documentation of buildings, locations and physical objects for reconstruction and renovation. These advanced technologies are key to creating new approaches to business processes [7].

3. 3D LASER SCANNING

Laser scanning has many advantages over traditional methods because the observer can quickly and easily collect a large amount of data in a relatively short period of time. The collected data are a set of millions of points that form the image of the so-called "point clouds" of the research area. In addition to collecting data quickly, laser scanning is the perfect solution for relatively inaccessible areas, complex details, or may be dangerous and/or unsafe to survey in the traditional way. Laser scanners capture all structure elements and create a photographic record during recording. After the scan is completed, the data is processed by visualization and modeling software to ensure a reliable and accurate 3D view of the surface or object being observed.

3.1. 3D LASER SCANNER MODELS

The history of simple laser scanners dates back to the 1960s. Then in 1985, simple scanners were replaced by LiDAR (Light Detection And Ranging) systems with high-quality scanners that use laser beams to collect data related to objects and surfaces. Modern laser scanners can collect detailed point clouds, and by subsequent processing in point cloud processing software, these geospatial datasets create digital 3D models of the scanned environment or relationships of topographic features and structures.

Laser (Light Amplification by Stimulated Emission of Radiation) is an amplification of light by stimulated emission of radiation. Device that creates and amplifies coherent electromagnetic, most often monochromatic, narrowly directed radiation [2]. The main feature of this light is the ability to

focus on a point of small diameter (<1 mm), which is impossible with natural light. Laser scanning is a completely efficient and automated method of collecting spatial data. The common name for this data collection method is LiDAR (Light Detection and Ranging). LiDAR is an automated, active, optical-mechanical process of collecting spatial data available from current recording sites [7].

There are several types of laser scanners on the market depending on their operating platforms, and they are divided into three categories [2]:

- Terrestrial Laser Scanner (TLS) - A laser scanner is also known as a terrestrial LiDAR. It is usually placed on a tripod to perform static laser measurements. They have the highest accuracy among all types of scanners available on the market.
- Airborne Laser Scanner (ALS) - known as Airborne LiDAR, refers to a laser scanning device installed on an aircraft or unmanned aerial vehicle. It is known as mobile LiDAR because it can be easily transported from one place to another. The accuracy of air scanners is relatively low due to its mobility.
- Mobile Laser Scanner (MLS) - a hand-held scanner. They are relatively smaller in size and lighter in weight so they can be easily transported from one place to another.

The main steps in terrestrial scanning are defining measurement parameters in a laser scanner, placing the scanner in the position from which the object or part of the object will be scanned, starting the scanning process, collecting point cloud data, data transfer and processing in software and creating 3D BIM models using point cloud data.

3.2. LASER SCANNER LEICA BLK360

The Leica BLK360 (Figure 1) is a 3D laser scanner with integrated spherical image capture and panoramic thermographic sensor that quickly and reliably creates a point cloud. It is easy to use where a quick and efficient scan of the subject starts at the touch of a button. Depending on the measurement setting from one point of view, it only takes a few minutes to record the intended part for scanning. The usual time per point of observation is approx. 3 min.



Figure 1. Laser scanner Leica BLK360

The scanner has small dimensions, height 165 mm (height) x 100 mm (diameter) and weighs only 1.1 kg, which allows easy and fast transfer of the instrument from point of observation to point of observation and easy manipulation in the field. The Leica BLK360 records 360 000 points per second. The minimum distance of the scanned surface is 0.5 m, and the maximum is 60 m, which makes it a scanner for indoor but also less demanding external scans. The field of view is 360 ° (horizontal) x 300 ° (vertical), while the temperature range is from +5 ° C to +40 ° C [11].

3.3. SOFTWARE LEICA CYCLONE REGISTER360

The Leica Cyclone REGISTER 360 (Figure 2) is a module for processing point clouds of 3D laser scanning projects. The module enables automatic or individual loading of scanned data, fast and easy data processing, which is manifested in defining the overlap of "cloud points" in horizontal and vertical sense, analysis of data in the form of statistical indicators of overlap percentage and accuracy of the obtained 3D model. The software allows easy manipulation of scanned models and a clear and simple 3D display [12].

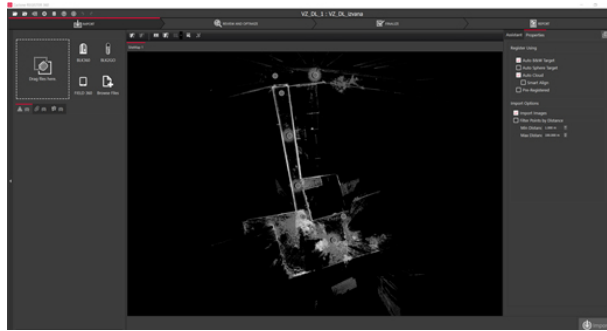

Figure 2. Main screen in Leica Cyclone360 software

4. 3D LASER SCANNING OF THE BUILDING FOR THE PURPOSE OF REHABILITATION AND RECONSTRUCTION

In reconnaissance of the scanning area, it is necessary to check that the whole environment is visible and clean for scanning to obtain a sufficient number of points and that there are any obstacles that need to be removed or taken into account during scanning. Inspection is mandatory for the needs of good scanning planning and all to ensure good connections between each room, floor or outdoor area provided for scanning.

For the needs of test 3D laser scanning, a building was selected that is intended for reconstruction and renovation. The location itself is divided into a courtyard and a residential part. In order to obtain a reliable 3D model of the exterior of the building was observed with a total of 8, and the interior with 18 points of observation – two point of observation were rejected (Figure 3).

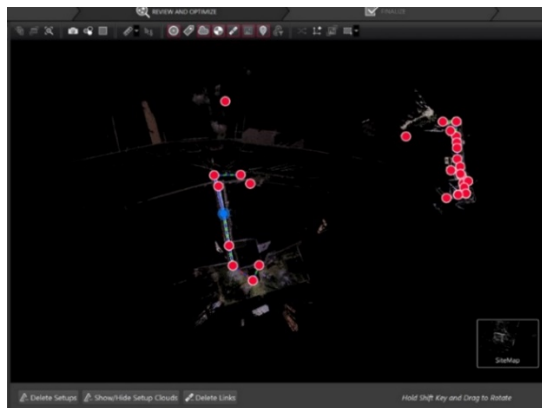

Figure 3. Schedule raw processing points of observation outside and inside the building

Scanning of the inner and outer part was done without technical problems and obstacles. Measurement at one point observation took approximately four minutes. During the measurement, special attention was paid to the reliable overlaps of the scanned material between the stops. If the need arose after processing, additional scans were observed. The first step of the analysis is to review the raw data (Figure 4), which were then processed in the Cyclone REGISTER 360 software.

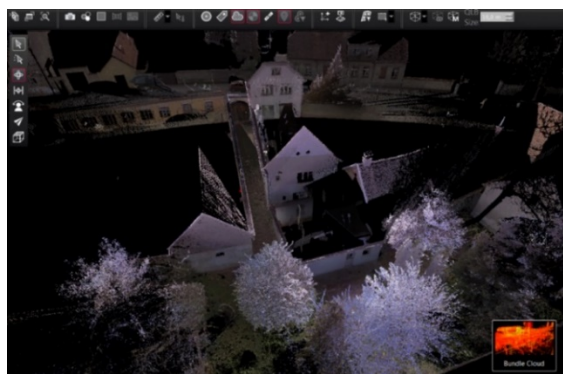

Figure 4. Display of raw cloud data

Data processing is performed by selecting the two closest interconnected points of observation. After "cleaning" the scanning model from excess point clouds that do not belong to the model itself, the connection between the two point of observations is created by a link that is automatically defined during basic loading. Based on the defined link, the geometry of adjacent scans is checked. Comparison and overlap of "cloud data" is done manually (by selecting identical points) because the originally loaded data is not completely overlapped in a way that follows the geometry of the observed space (Figure 5) [6].

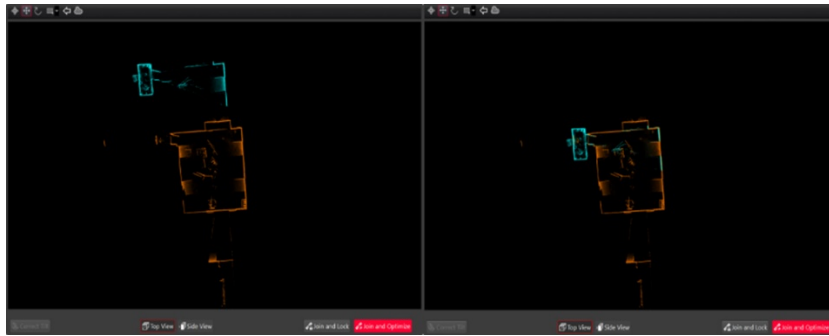

Figure 5. Example of cloud model overlap

Manual overlapping can be done in horizontal and vertical planes. The software also allows point cloud rotation for the purpose of easier and simpler overlapping of scanned parts. After the data from two points of view are overlapped, the option of optimizing them is started, and after the end of the procedure, the data of the percentage overlap of point clouds is obtained, as well as the reference value of overlapping accuracy. After final processing, the connections between the stops scanned outside the building (Table 1) and inside the building (Table 2) were defined. From the statistics, it can be concluded that the percentage overlap is higher at shorter distances, while at longer distances, it is lower.

Table 1. 3D model link statistics - outside scanning

Link	Distance from the point of observation (m)	Realized percentage of overlap (%)
Link 1	20.566	48.26
Link 2	9.498	79.07
Link 3	4.002	40.47
Link 4	11.070	53.90
Link 5	6.901	40.19
Link 6	17.969	27.03
Link 7	13.455	38.20
Link 8	8.871	51.42
Link 9	8.420	14.66
Link 10	5.621	40.38

What is definitely to be recommended is that the person who performed the scan should also process the scanned data. Namely, if it is a simpler object, then photographs and scanned data are quite enough for a person who has not seen the object to perform data processing. However, for more complex objects and buildings, it is recommended that the person who scanned also perform data processing because he knows best what surfaces, surfaces and parts of the object are scanned. It is also recommended to keep a log or sketch with the layout of the standpoint in order to facilitate the identification of the overlap of the scanned data. This is especially important in parts where there is no high percentage of scan data overlap.

Table 2. 3D model link statistics - inside scanning

Link	Distance from point of observation (m)	Realized percentage of overlap (%)
Link 1	0.744	76.64
Link 2	1.441	58.20
Link 3	1.877	70.91
Link 4	2.119	77.32
Link 5	3.773	58.65
Link 6	2.751	48.42
Link 7	3.395	28.55
Link 8	2.478	60.16
Link 9	3.995	54.64
Link 10	2.660	56.42
Link 11	1.826	44.11
Link 12	2.566	43.20
Link 13	2.177	62.87
Link 14	2.601	20.16
Link 15	2.606	16.26
Link 16	3.372	47.25
Link 17	5.018	68.42
Link 18	7.125	45.43
Link 19	4.334	52.77
Link 20	3.945	61.09
Link 21	9.002	29.82

After processing all the defined connections between point clouds and meeting the statistical criteria for outside scanning (Figure 6 up) [6] and inside (Figure 6 down), a final 3D model with approximately 197 million points was created. Data for further use in some of the BIM software can be exported in several data models, which allows a wider application of this type of laser scanning.

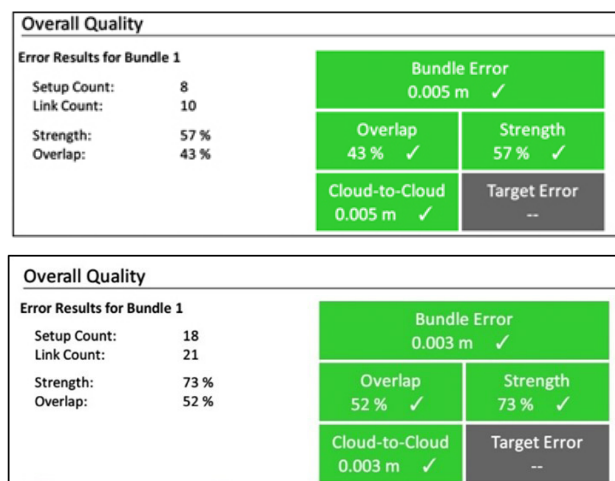

Figure 6. Outside(up) and inside (down) scan cloud model overlap statistics

The achieved results of the accuracy of scanned models from the outside and inside are shown in Figure 6 (statistics for outside - up and especially for inside scanning - down are shown separately). The manufacturer claims an accuracy of 6 mm at a distance of 10 m and 8 mm at a distance of 20 m, with the performance having been noted to adhere to the specifications [11]. A comparison of the accuracy of the model shows that the accuracy of the 3D inside model is 3 mm and the outside is 5 mm, which fully corresponds to the official factory specifications.



Figure 7. Created 3D model - view from the outside

In further analysis, the created 3D model (Figure 7) enables obtaining geometric information from point clouds that can be further used in preparation for renovation or reconstruction or provide all the necessary information for project implementation. From the model, the length between the characteristic points can be determined (Figure 8), ie the area of the selected part of the observed object.

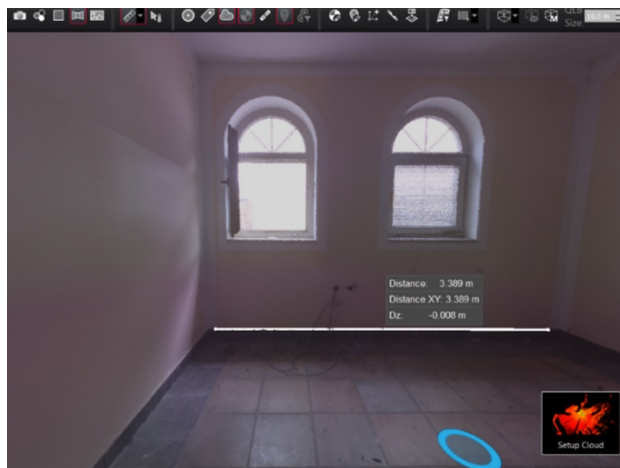

Figure 8. Determining the distance between characteristic points

For additional analysis and observation of the scanned area, it is possible to display a total of five types color of cloud points, one of which is the Intensity cloud model (Figure 9). Other one are Color from Scanner, Grayscale Intensity Map, Color By Bundle and Color By Setup. Each of these models provides commendable visual data that helps define and identify scanned surfaces, especially when it comes to surfaces that have more demanding relief. The scanned area is easily recognized using one of these modules, and further data processing is facilitated.

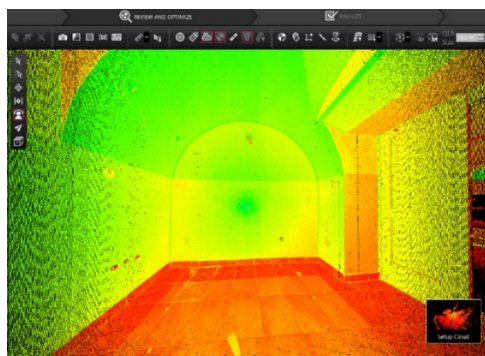

Figure 9. Intensity cloud model

In addition to point clouds, the instrument has the ability to create high-resolution photographs of the selected object, which can greatly facilitate the project of renovation or reconstruction (Figure 10). Enlarging, reducing, or rotating a selected portion of a photo allows for review and analysis, reliable planning down to the smallest detail.

Photographs taken by a panoramic camera also give special value to project documentation because they provide reliable information about the condition of each part's scanned object. In addition to current information, this kind of data provides valuable archival material for the future.



Figure 10. Photo of part of the scanned model from BLK360

Creating a report gives the project's final report with all the necessary information for its analysis. It is important to emphasize that the point cloud model can provide all the necessary dimensions in the observed object and export the final point cloud model in appropriate formats (.e57, .pts, .ptg and .ptx) which can be further loaded into other BIM software [12].

5. DISCUSSION AND CONCLUSION

For the needs of renovation or reconstruction of the building, the key step is to analyze and assess the building or its actual condition. Knowledge of the position, geometry, size, shape, and components is required for reliable design, further analysis, and planning. Currently, several laser scanning methods are used and the choice of technique depends on the appearance, complexity and size of the building and the measurement conditions. Terrestrial 3D laser scanning is a method that is widely used in practice today. This is especially true for older buildings, which often have no documentation or are incomplete and there is no reliable geospatial information. The laser scanning method is often used for documentation and supervision in civil construction projects. The large number of collected data points results in a high content of information which allows quick and detailed analysis of even the most complex objects, especially hard-to-reach ones, such as facades or parts of roof structures. In addition to scanning, an important piece of information in renovation and reconstruction projects are high-quality photographs that add value to this method of collecting geospatial data. It is also important to emphasize that conventional geodetic methods are accurate and reliable, but they are time consuming and creating 3D models from such collected data is an extremely complex and time consuming process.

With the development of new geomatic technologies in terms of collecting the necessary geospatial data, the paradigm of the process and procedures of renovation and reconstruction of the building is changing. The application of terrestrial laser scanning provides additional value for faster and easier analysis of the existing condition of the building, and application in further processes of project management and implementation in the form of BIM technology.

The paper clearly presents the application of 3D technology, terrestrial laser scanning and point clouds, as advanced geomatic technologies for collecting geospatial data. This method provides an excellent basis and wealth of information for planning and implementation of business processes in terms of geometric analysis of the building. The application of advanced additional analyzes from accurate photographs of the building provides an overview of the actual condition and excellent geospatial information for the preparation of technical bases needed for reconstruction or renovation. The advantages of 3D laser scanning in terms of productivity and cost-effectiveness can be clearly seen from the implemented project. Special emphasis should be placed on saving time in relation to conventional geodetic methods. Also accuracy and precision are at a high level because modern technique is far more accurate and precise compared to traditional measurement, where frequent human error is eliminated. The performed laser measurements provide digital detailed documentation where the probability of any omission is minimized. Disadvantages of 3D laser

scanning as seen in this example is the lack of digital information of the upper outer surfaces such as roof or chimney but the same can be compensated by additional measurements of mobile laser scanning by drone and integrated into the final 3D model.

LITERATURE

- [1] M. Radujković i dr., "Organizacija građenja". Sveučilište u Zagrebu, Građevinski fakultet, Zagreb, 2015.
- [2] R. Sacks, Ch. Eastman, G. Lee, P. Teicholz, "BIM Handbook A Guide to Building Information Modeling for Owners, Designers, Engineers, Contractors, and Facility Managers". Third Edition, Hoboken, New Jersey. Wiley, 2018.
- [3] Njvaro Đ., "Znanje o upravljanju projektima: (vodič kroz PMBOK)", Mate, Zagreb, 2011.
- [4] C.A.L. León-Robles, J.F. Reinos-Gordo, J.J. G González-Quiñones, "Heritage Building Information Modeling (H-BIM), Applied to A Stone Bridge", ISPRS Int. J. Geo-Inf, 8 (3), 121, 2019.
- [5] M. Jurčević, M. Pavlović, H. Šolman H., "Opće smjernice za BIM pristup u graditeljstvu", Hrvatska komora inženjera građevinarstva, Zagreb, 2017.
- [6] D. Lovrenčić, "Primjena 3D skeniranja u svrhu pripreme tehničkih podloga za rekonstrukciju i sanaciju građevine". Diplomski rad, Odjel za graditeljstvo, Sveučilište Sjever, Varaždin, 2021.
- [7] M. Murphy, A. Corn, J. Cahill, K. Eliashvli, A. Chenaux, C. Pybus, R. Shaw, G. Devlin, A. Deevy, L. Truong-Hong, "Developing Historic Building Information Modelling Guidelines and Procedures for Architectural Heritage in Ireland", The International Archives of the Photogrammetry, Remote Sensing and Spatial Information Sciences, Volume XLII-2/W5, 26th International CIPA Symposium, 28 August–01 September, Ottawa, Canada, 2017.
- [8] Narodne novine, "Zakon o gradnji". Službeni list Republike Hrvatske, Pub. L. No. NN 153/13, Zagreb, 2013.
- [9] Narodne novine, "Tehnički propis za građevinske konstrukcije", Službeni list Republike Hrvatske, NN 125/19, Zagreb, 2019.
- [10] Narodne novine, "Pravilnik o obaveznom sadržaju i opremanju projekata građevina", Službeni list Republike Hrvatske, NN 118/19, Zagreb, 2019.
- [11] Leica Geosystems "Data Sheet Leica BLK360" Internet: <https://leica-geosystems.com/products/laser-scanners/scanners/blk360> [Feb. 07, 2022]
- [12] Leica Geosystems "Leica Cyclone 3D Point Cloud Processing Software".Internet: <https://leica-geosystems.com/products/laser-scanners/software/leica-cyclone/leica-cyclone-register-360> [Feb. 08, 2022]
- [13] H.J. McNeil, K.O. Hartley, "Project planning and performance" , Project Management Journal, 17(1), pp. 36-44, 1986.
- [14] U. Uotila, A. Saari, J.M. Junnonen, "Investigating the barriers to laser scanning implementation in building refurbishment", Journal of Information Technology (ITcon), Vol. 26, pp. 249-262, 2021.



Stevan Radojčić, Visoka građevinsko geodetska škola Beograd, stradojic@sezampro.rs

ASSESSMENT OF THE POSITIONAL ACCURACY OF THE TOPOGRAPHIC MAP 1:50.000 MADE BY MGI

Abstract

The paper describes the methodology of testing and evaluating the positional accuracy of the topographic map of Serbia in the scale of 1: 50 000, published by the Military Geographical Institute from Belgrade, and gives an overview of the obtained results. The assessment of accuracy is done by comparing the planimetric coordinates of the map points to the coordinates of the same points as determined by a field measurements of very higher accuracy, according to American National Standard for Spatial Data Accuracy.

Keywords: Positional accuracy, Topographic map 1:50. 000, MGI, NSSDA

ОЦЕНА ПОЛОЖАЈНЕ ТАЧНОСТИ ТОПОГРАФСКЕ КАРТЕ 1:50.000 У ИЗДАЊУ ВГИ

Сажетак

У раду је описана методологија испитивања и оцењивања положајне тачности топографске карте Србије у размери 1:50 000 у издању Војногеографског инситута из Београда, и дат је преглед добијених резултата. Оцена тачности је извршена на основу поређења планиметријских координата тачака мерених на карти са координатама истих тачака одређеним теренским мерењима пуно веће тачности, према Америчком националном стандард за тачност просторних података.

Кључне ријечи: Положајна тачност, Топографска карта 1:50.000, ВГИ, NSSDA

1. INTRODUCTION

Quality of the cartographic products and spatial databases is of great importance for both, manufacturers and users. With the growing importance of data on space for everyday life, the importance of defining the concept of quality of data on space, its content, as well as the way of testing and presenting results has grown.

The positional (geometric) accuracy of the map is, according to the ISO19113 standard, one of several elements of the map quality that can be quantified (Table 1) [1]. Positional accuracy determines how closely the position of discrete objects shown on a map or in a spatial database agree with the true position on the ground.

Table 1. Elements and sub/elements to categorize data quality aspects in ISO 19113

ELEMENTS AND SUB-ELEMENTS	DESCRIPTION
Completeness commission omission	Presence or absence of features, their attributes and relationships
Logical consistency conceptual consistency domain consistency format consistency	Degree of adherence to logical rules relating to data structure, attributes and their relationships
Positional accuracy absolute or external relative or internal gridded data	Closeness of positions (reported coordinate values, relative positions of features or gridded data positions values) to a reference ("true") values
Temporal accuracy accuracy of a time measurement temporal consistency temporal validity	Temporal accuracy of attributes and their mutual relationships
Thematic accuracy classification correctness non-quantitative attribute correctness quantitative attribute correctness	Accuracy of quantitative attributes and correctness of non-quantitative attributes, as well as attribute classifications and their relationships

Positional accuracy has traditionally been evaluated using control points. Following this idea, there are many statistical Positional Accuracy Assessment Methodologies (PAAM), for example: National Map Accuracy Standard (NMAS), Engineering Map Accuracy Standard (EMAS), National Standard for Spatial Data Accuracy (NSSDA), NATO STANAG 2215, ASPRS Accuracy Standards for Large-Scale Maps (ASLSM), ASPRS Positional Accuracy Standards for Digital Geospatial Data (ASDGD), etc.

Different maps have different positional accuracy because of different influences of random and systematic errors originated from methodology of map production. Moreover, even the different sheets within the same multi-sheets map could have different positional accuracy

A variety of factors affect the positional accuracy of digital spatial data. Error can be introduced by: the specifications of the techniques used for the survey and further processing, ground control reliability, source material, digitizing methods, generalization, symbol interpretation...and printing limitations. Individual errors derived from any one of these sources is often small, but collectively, they can significantly affect data accuracy. The PAAM give an overall assessment, and if it is not in line with expectations, the causes must be analyzed separately, by other methods and procedures.

It is known that positional accuracy is of great importance for the usefulness of maps, specially if it refers to large scale maps, such as digital topographic map at scale of 1:50000. It is a basic map of wide application used in navigation, planning and monitoring. This map is the most frequently used map in the Serbian Armed Forces (like in others armies, too), which is the main reason for checking its quality.

2. STANDARD NSSDA

For evaluation, the procedure provided by the American National Standard for Spatial Data Accuracy (NSSDA) from 1998 [2] was used, with certain modifications. The standard is developed by Federal Geographic Data Committee, so not by a standardization organization, but it turned out to be suitable for this occasion. The NSSDA provides a method for assessing accuracy of geographical data in both printed and digital (raster and vector) form, for horizontal as well as vertical accuracy. For positional accuracy evaluation, it uses the traditional approach: comparing two sets of data – one with values taken (measured) from a cartographic product and another with values of the same quantities (ie. same points) with reference („true“) value.

Reference values must be at least three times more accurate than the first one, and must be acquired separately from the data set being tested. This more accurate source material could be, for example, surveyed data or values taken from a much larger scale product, with scale ratio of 1:3 or more. In the case described in this paper, the coordinates of the control points were determined by field measurements, with an accuracy that is more than 20 times higher than the expected accuracy of the map.

For the purpose of accuracy testing only well-defined points are used. By standard, well-defined points are those that are easily visible or recoverable on the ground, on the independent source of higher accuracy, and on the product itself. In the case of maps, suitable well-defined points are represent right-angle intersections of roads, railroads or other linear mapped features, monuments, lonely items, etc.

Since the positional accuracy of one map sheet is assumed to be uniform, the well-defined points must be evenly distributed across the map sheet. Within a sheet, points may be distributed so that are spaced at intervals of at least 10% of the diagonal distance across sheet *and* at least 20% of the points are located in each quadrant of the map sheet (Figure 1.)

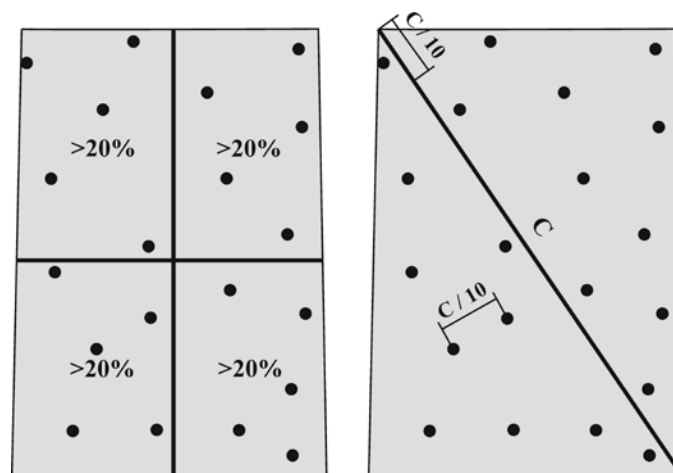

Figure 1. Recommended distribution and distance of test points

The standard requires a minimum of 20 test points shall be tested, distributed to reflect the geographic area of interest.

Unlike the NSSDA which does not take care what geographical element that point belongs to, in this assessment the points for assessment horizontal positional accuracy are chosen to belong to the three basic geographic elements, printed in three different colours – black (roads, houses, railway, etc.), blue (hydrography) and green (vegetation) or combination of them (cross points of different geographic elements, for example cross-point of road and railway and so on). In accordance with this, a matrix of well-defined points was formed for each map sheet (Figure 2). That matrix was used in planning and governing the estimation process (S – black, H – blue, V – green).

Also, the minimum number of test points per sheet has been increased to 25.

	S	H	V
S	12	7	2
H		4	1
V	$\Sigma=27$		1

Figure 2. Matrix of well-defined points on one sheet

2.1. CALCULATING POSITIONAL ACCURACY ESTIMATION

For *horizontal accuracy estimation*, for each data set the root mean square error by axes ($RMSE_y$ and $RMSE_x$) are calculated, according to:

$$RMSE_y = \sqrt{\frac{1}{n} \sum_{i=1}^n d_{y_i}^2}; RMSE_x = \sqrt{\frac{1}{n} \sum_{i=1}^n d_{x_i}^2} \quad (1)$$

where:

$dy_i = (y_{map} - y_{ref})_i$ – differences of the measured and reference values along the y - axis

$dx_i = (x_{map} - x_{ref})_i$ – differences of the measured and reference values along the x - axis

n – the number of test points

i – an integer ranging from 1 to n

Horizontal error at point i is defined as:

$$RMSE_i = \sqrt{d_{y_i}^2 + d_{x_i}^2} \quad (2)$$

and RMSE of the data set (sheet) is:

$$RMSE_r = \sqrt{\frac{1}{n} \sum_{i=1}^n dy^2 + \frac{1}{n} \sum_{i=1}^n dx^2} = \sqrt{RMSE_y^2 + RMSE_x^2} \quad (3)$$

In order to get accuracy reported at the 95% confidence level (denote by $Accuracy_r$), further computing depends on whether $RMSE_y$ and $RMSE_x$ are equal to each other or not.

If $RMSE_y = RMSE_x$, than:

$$RMSE_r = \sqrt{2 \cdot RMSE_y^2} = \sqrt{2} \cdot RMSE_x = 1,4142 \cdot RMSE_y = 1,4142 \cdot RMSE_x \quad (4)$$

If errors are normally distributed and independent in each the x- and y- component error, the factor 2,4477 is used to compute horizontal accuracy at the 95% confidence level [3], so:

$$Accuracy_r = 2,4477 \cdot RMSE_r / 1,4142 = 1,7308 \cdot RMSE_r \quad (5)$$

Analogous, if $RMSE_y \neq RMSE_x$,

$$\begin{aligned} Accuracy_r &= 2,4477 \cdot 0,5 \cdot (RMSE_y + RMSE_x) \\ &= 1,2238 \cdot (RMSE_y + RMSE_x) \end{aligned} \quad (6)$$

For *vertical accuracy estimation*, for each data set the root mean square error of the vertical coordinate (height) is calculated, according to:

$$RMSE_z = \sqrt{\frac{1}{n} \sum_{i=1}^n (z_{map} - z_{ref})_i^2} \quad (7)$$

where:

z_{map} – vertical coordinate of the i th test point in the dataset

z_{ref} – vertical coordinate of the i th test point in the independent source of higher accuracy

n – the number of test points

i – an integer ranging from 1 to n

If vertical error is normally distributed, the factor 1,9600 is applied to compute linear error at the 95% confidence level [3]. Therefore, vertical accuracy, $Accuracy_z$, shall be computed by the formula:

$$Accuracy_z = 1,9600 \cdot RMSE_z \quad (6)$$

Although the NSSDA does not provide procedures for blunder and systematic error detection, the differences between the measured and reference values of each sheet were tested for them according to the testing procedures developed in NATO STANAG 2215 [4] and adjusted for this occasion [5].

3. TOPOGRAPHIC MAP 1:50.000 MADE BY MGI

The Military Geographical Institute (MGI) is the oldest Serbian geodetic and cartographic institution, founded in 1876. From its establishment until today, MGI is the only one that performs systematic surveys and issues topographic maps for the territory of the Republic of Serbia.

The map whose accuracy was assessed on this occasion is a topographic map in the scale of 1:50.000, created in the period from 1988 to 1995 by photogrammetric survey, therefore not by generalizing a topographic map 1: 25.000.

The territory of Serbia is covered by 204 sheets with format 15'x15'(sheets are printed in 8 colors) that were scanned and georeferenced in 2003 (Figure 3.).

A laser scanner-photoplotter Optronics P-5040-HR made by Intergraph was used for the scanning of the map sheets. The sheets were scanned with *.tiff format, with RGM scanning modul with resolution 254 ppi, or 0,1 mm related to the map scale (or 5 m actual size) [6]. The georeferencing was made with domestic software Mapsoft 2000 (modul Digiscan 2000), designed for georeferencing binary and color rasters, about 190 points on each sheet (crosses of gridlines) and method of collocation with filtering in calculating transformation parameters for each sheet. A georeferencing sheet error of less than 2 m (1/2 pixel) was considered good quality.

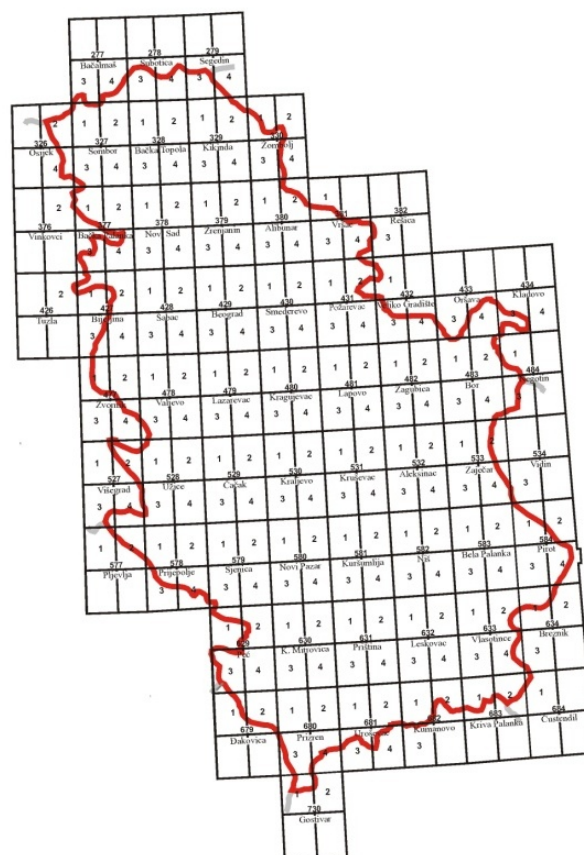

Figure 3. Topographic map 1:50.000 review sheet

3.1. A PRIORI ACCURACY ASSESSMENT

The a priori accuracy assessment is an integral part of the geometric accuracy assessment of the map. This is a preliminary assessment obtained by summing up the individual errors that occur in the process of making a map, according to the rules of propagation of errors. In order to determine it, it is necessary to know the process of making a map in detail, ie to consider the sources of errors in individual phases of map making and the rules of their actions. Although the estimation of individual errors cannot be performed exactly, the previous estimation of accuracy is important both in the preparatory work for the production of the map and in the accuracy tests performed after the production of the map.

Although an a priori accuracy estimation has some deficiency, it is of help in the preliminary phase of map producing and in the a posteriori accuracy estimation phase. Preliminary accuracy assessment for topographic map 1: 50.000 was performed based on 10 errors significant for defining positional accuracy (Table 2.).

Table 2. Individual errors in the proces of map making

Notation	Error of	Value ± [mm]
σ_1	cartographic source	0,15
σ_2	Mounting of editing original	0,07
σ_3	copying the editing original	0,13
σ_4	generalizing and drawing the compiling original	0,20
σ_5	making engraving templates	0,08
σ_6	engraving	0,12
σ_7	fitting new content	0,12
σ_8	color matching	0,10
σ_9	scanning and georeferencing	0,11
σ_{10}	measurements on map	0.04

Accordingly, the total error is:

$$\sigma = \sqrt{\sigma_1^2 + \sigma_2^2 + \sigma_3^2 + \dots + \sigma_{10}^2} = 0,35 \text{ mm} \quad (5)$$

The values of individual errors are taken from the relevant literature and reported research (eg [7]), except the error of measuring coordinates on the map σ_{10} which was determined within this research, under the same conditions under which measurements were later performed (the same mouse, monitor, screen magnification, software, operator, etc.) [8].

In order to get accuracy reported at the 95% confidence level (denote by $Accuracy_{apr}$), given value is multiple with 1,7308 ie $Accuracy_{apr} = 1,7308 \cdot \sigma = 0,60$

3.2. ASSESSMENT OF HORIZONTAL ACCURACY

The assessment of horizontal accuracy was performed in two ways: (1) by differences of coordinates of *trigonometric points* measured on the map and correspondent reference coordinates taken from the Catalog of the state trigonometric network and (2) by differences of coordinates of clearly defined points measured on the map and correspondent reference coordinates measured in the field GPS method.

3.2.1. Assessment using trigonometric points

The importance of assessing the horizontal accuracy of the map based on the points of the trigonometric network is that they provide insight into the upper limit of the accuracy of the map. Therefore, no other element of the map content should have better indicators of horizontal accuracy. All trigonometric points for 158 sheets were processed. That is 77% of total number of sheets, (Figure 4., left), ie an average of about 170 points per sheet. Twenty-one sheets covering the territory of neighboring countries were assessment on the basis of points on Serbian territory only, ie the points were not evenly distributed throughout the sheet.

In the first step, differences of measured and reference coordinates were formed for each sheet, which were analyzed in order to detect and eliminate possible gross errors. In the second step, the differences were processed according to the NSSDA. Processing was performed in Microsoft Excel, for each sheet in a separate file (Figure 5).

The average value of the *Accuracy_r* measure (95% confidence level) is 15,6 m (0,31 mm), and ranges from 10,7 m to 23.6 m (0.21 mm to 0.47 mm).

It should be noted that the number of measurements rejected based on the blunder detection test was less than 5% per sheet.

So, it can be concluded that the horizontal positional accuracy of topographic map 1: 50.000, estimated on this way, is consistent with the expected.

Since horizontal accuracy indicators differ from sheet to sheet, it is justified to ask the question whether the achieved accuracy is homogeneous, ie whether the differences in accuracy indicators are significant. In order to analyse the homogeneity of the different map sheets, the ANOVA method was used [9] (available as a module in MS Excel). The analysis showed that the obtained results can be considered, in statistical terms, as results of the same accuracy, except for twelve sheets that had excessive errors.

3.2.2. Assessment using well-defined points

This assesment was performed for 76 sheets. That is 37% of total number of sheets (Figure 4., right), but it should be borne in mind that it was not possible to measure in the territory of Kosovo and Metohija and that a number of sheets mostly cover the territory of neighboring countries where it was also not possible to measure. In addition, field measurements were not performed systematically, but from time to time, often after the completion of some other task in that territory. However, the survey covered all categories of terrain in Serbia (plains, mountains, forests, urban and rural, etc.) and all characteristic periods of making a topographic map 1: 50,000.

The field measurements on well-defined points were carried out with a GPS Trimble *Geoexplorer 3* receiver. The receiver was regularly tested on control points. The accuracy of the GPS positioning in national map grid system, as defined by the root mean square error of a single point was 2.51 m, or half of a pixel on map sheet.

The number of well-defined points per sheet ranged from 25 to 38, selected and arranged according to NSSDA requirements. The most numerous were the points shown on the map in black color (intersections of roads, railways or other linear mapped features, monuments, lonely buildings, etc.). The points shown in blue (hydrography) were less represented, and the least represented points were green (vegetation); on many sheets not a single suitable point of vegetation could be found.

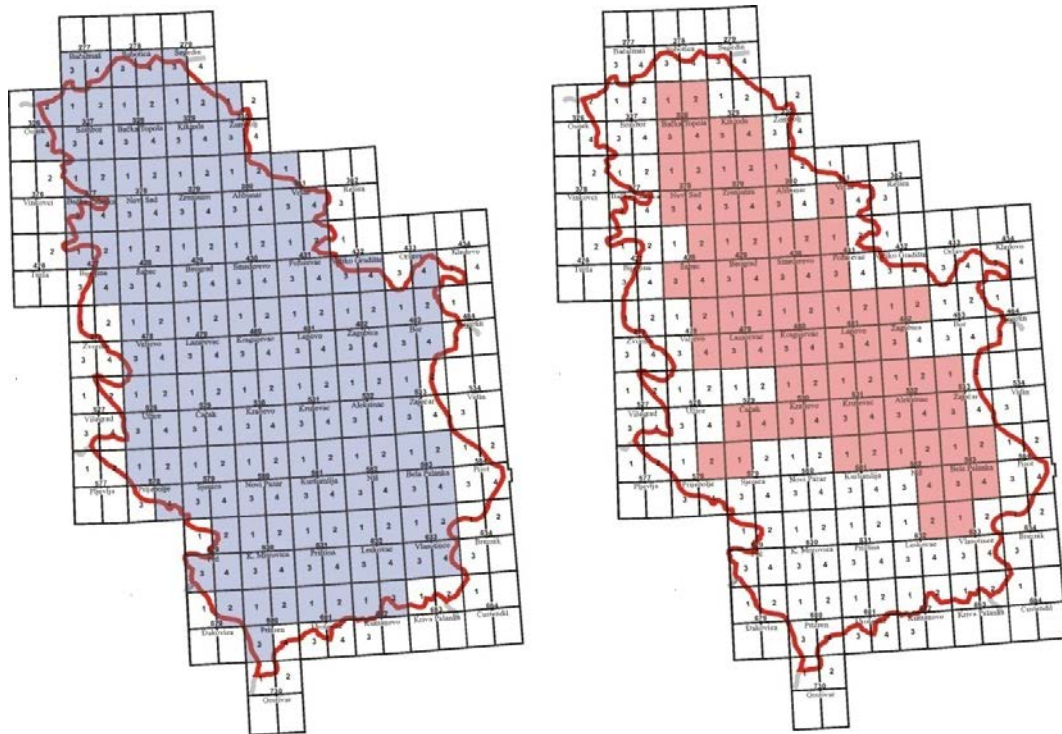

Figure 4. Assessment using trigonometric points (left) and assessment using well-defined points (right)

The coordinates obtained by GPS measurements were compared with the map coordinates of the common points in the same way as it was done for trigonometric points.

The average value of the *Accuracy_r* measure (95% confidence level) is 23,9 m (0,48 mm), and ranges from 19,7 m to 35.6 m (0.39 mm to 0.71 mm).

It should be noted that the number of measurements rejected based on the blunder detection test was also less than 5% per sheet.

After the analysis of homogeneity, it was found that nine sheets were statistically different and they were rescanned and rechecked. But, that did not change the situation. Further analyzes did not give a definite conclusion about the possible causes.

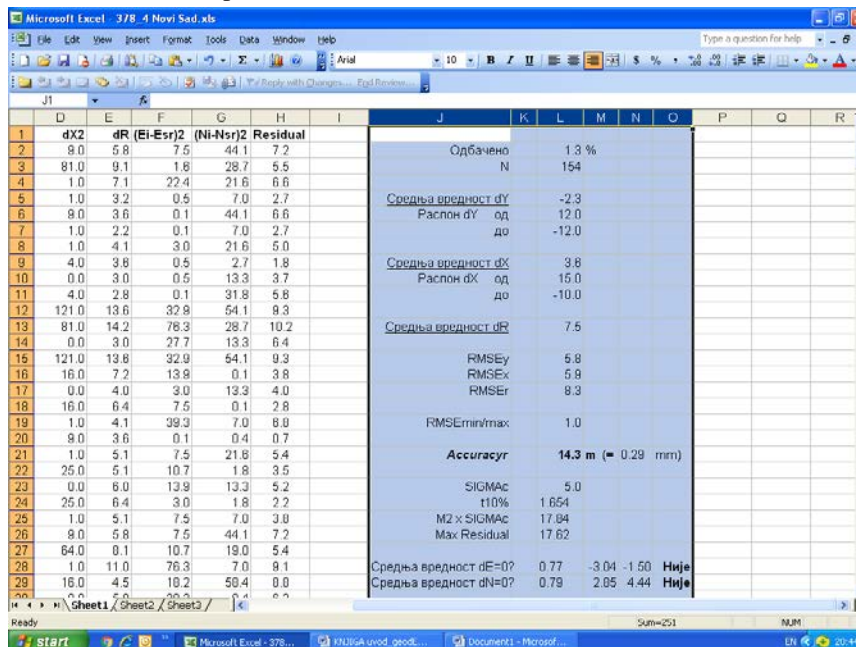

Figure 5. Excel workshcer for calculating the statistics

3.3. ASSESSMENT OF VERTICAL ACCURACY

The vertical accuracy has not been assessment according to NSSDA because 1: 50.000 topographic map users have access to a digital elevation model that allows them to determine altitudes with better accuracy than the accuracy of height measurements on the map.

4. CONCLUSION

The US National Standard for Spatial Data Accuracy is a simple and low demanding standard, but very efficient one. It can be preferable standard for accuracy assessment in Military Geographical Institute, but few smaller improvements have to be done.

The first of all, the minimal sample of well-defined points per sheet must be some larger, ie. 25-30 instead of 20. Then, well-defined point have to belong to all types of uniformly distributed geographic elements. And final, the coordinate differences of measured and reference coordinates must be tested for outliers. Those are the basic improvements, noticed during implementation NSSDA on topographic map 1:50.000 made by MGI.

The analysis of the horizontal positional accuracy of this topographic map shows that this map has an accuracy that meets the most modern accuracy requirements, regardless of the fact that the content and technology used to make the map are three decades old.

This research confirmed the need to assess the geometric accuracy of a map immediately after its production, in line with the dynamics of its production, before giving it to users. In this way, possible problems with accuracy could be analyzed and eliminated, and the assessment of accuracy could be communicated to the user. In addition, the content of the map would be more up-to-date and it would be easier to choose well-defined points.

Field measurements could be used to improve the positional accuracy of MGI vector maps, as well as to be used for future accuracy and accuracy assessments of other large-scaled maps.

LITERATURE

- [1] The International Organization for Standardization, „ISO19113: Geographic information – Quality principles“, Genève 2000.
- [2] Federal Geographic Data Committee / Subcommittee for Base Cartographic Data, „Geospatial Positioning Accuracy Standards: Part 3 : National Standard for Spatial Data Accuracy“. Internet: <https://www.fgdc.gov/standards/projects/FGDC-standards-projects/accuracy/part3/chapter3>,1998. [Dec. 22, 2021]
- [3] C. R. Greenwalt and M. Z. Shultz, „Principles of error theory and cartographic applications“, ACIC Tehnical report No. 96, US Air Force: Aeronautical Chart and Information Center, St. Louis, Missouri, 1968.
- [4] NATO, „Standardization Agreement (STANAG) 2215 : Evaluation of Land Maps, Aeronautical Charts and Digital Topographic Data“, NATO Standardization Agency, Brussels, 2002.
- [5] B. Bozic and S. Radojčić, „Horizontal Accuracy of 1:50 000 Digital Topographic Maps“. *Survey Review*, vol. 43(319), pp.94–104, 2011.
- [6] Z. Mladenovski, „Automatska digitalizacija topografske karte razmera 1: 25.000, *Zbornik radova Vojnogeografskog instituta*, Vol. 11, pp 153-159, Beograd, 2003.
- [7] M. Peterca, N. Radošević, S. Milisavljević, F. Racetin, „Kartografija“, Vojnogeografski institut, Beograd, 1974.
- [8] S. Radojčić, „Analiza horizontalne položajne tačnosti digitalne karte 1:50.000 izdanja Vojnogeografskog instituta“, PhD Thesis, Military Academy, Beograd, 2008.
- [9] G.E.P. Box, J. S. Hunter and W.G Hunter, „Statistics for Experimenters : Design, Innovation and Discovery“, Wiley, New York, 2005.



Petar Praštalo, University of Banja Luka, petar.prastalo@aggf.unibl.org

Ljiljana Brajović, University of Belgrade, brajovic@grf.bg.ac.rs

Dušan Prodanović, University of Belgrade, dprodanovic@grf.bg.ac.rs

USING OF LOW COST MOISTURE SENSORS IN LABORATORY EXPERIMENTS

Abstract

Soil moisture is one of crucial parameters in modeling and analysis of groundwater flow. Measurement of soil water dynamics improves the understanding of processes and is vital for good groundwater flow model calibration. Determining soil moisture change during time by laboratory methods, as an integral part of practical classes, requires significant material and financial resources. Nowadays, relatively cheap sensors for measuring soil moisture are available. They could be combined with affordable data loggers to speed up the measurement procedure and to reduce cost price. In this paper, the possibility of using these sensors for measuring soil moisture and their usage for the educational experimental exercises in a field of hydraulic engineering was investigated. The paper first presents the procedure of sensor calibration for four different sensors used in two types of soil, and then their usage in a simple hydraulic engineering experiment.

Keywords: Soil moisture, sensors, measurement, hydraulic engineering.

КОРИШЋЕЊЕ ЈЕФТИНИХ СЕНЗОРА ВЛАГЕ У ЛАБОРАТОРИЈСКИМ ЕКСПЕРИМЕНТИМА

Сажетак

Влажност тла је један од важнијих параметара у моделирању и анализи подземних вода. Познавање динамике промјене влажности тла је кључно у калибрацији симулационих модела. Одређивање влажности тла лабораторијским методама, као саставни дио практичне наставе, захтијева значајна материјала и финансијска средства. Данас су доступни релативно јефтини сензори за мјерење влажности тла, који комбиновани са широко распрострањеним дата логерима могу да убрзају поступак мјерења и да смање трошкове опреме. У овом раду истражена је могућност коришћења ових сензора за мјерење влажности тла и њихова примјена у експерименталном дијелу наставе хидротехнике. У раду је прво приказан поступак калибрације четири различита сензора коришћењем двије врсте тла и могућност њиховог коришћења за извођење једноставних експеримената.

Кључне ријечи: Влажност тла, сензори, мјерење, хидротехника.

1. INTRODUCTION

Soil moisture is the most important quantity in the study of soil in Civil Engineering and Agriculture. All soils are water permeable, because water can move through the space of interconnected pores between solid particles [1]. Determination of soil moisture content can be done with various measuring methods, devices and sensors. The choice of a method is based on its cost and the required accuracy. Drying and measuring the soil samples is a standard method for measuring soil moisture in the laboratory, but not for in situ measurements [2] nor can be used for measurement of soil moisture dynamic. Fortunately, the accuracy of moisture sensors is increasing, while their prices are decreasing [3]. In addition, a fact that their cost is low, is a good reason for their use in creating the laboratory experiments for students' practical work, as a part of teaching process in a field of hydraulic engineering at the Faculty of Architecture, Civil Engineering and Geodesy, University of Banja Luka.

2. METHODOLOGY

When choosing sensors for measuring soil moisture, it is convenient that they can be connected to the Arduino platform. The Arduino is an open source platform, based on the ease of use of hardware and software. *Arduino UNO* boards can read signals from a large number of sensors. In addition, *Arduino UNO* boards have the ability to send output data to various devices, so that the data can be displayed on the screen or acquired in file on the computer, etc. [4]. With addition of solid state memory and real-time clock, the Arduino platform can be used to build the cheap data logger system. In this research, Arduino board was used to read the analog output signals (voltages) from moisture sensors, while the results were displayed on a computer. Capacitive and resistive type moisture sensors were used for the testing.

In Figure 1 the Arduino board and the four sensors used to measure soil moisture are presented.

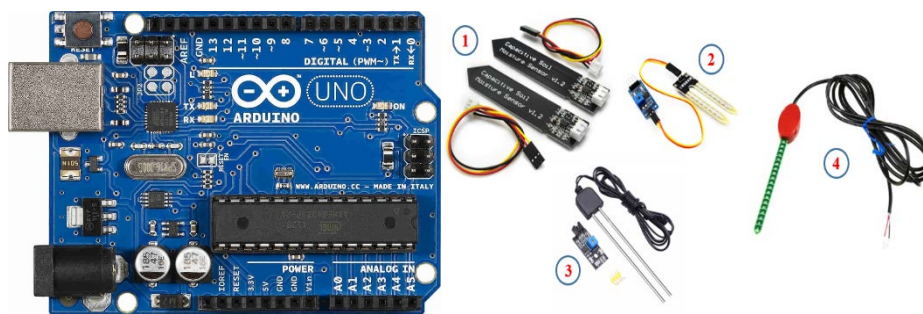

Figure 1. *Arduino UNO* board (left)[7], and soil moisture sensors (right)

Capacitive type soil moisture sensors usually have a structure of coplanar capacitors. When they are inserted in a soil, the soil moisture content influences their capacitance and by measuring the capacitance the moisture could be determined [3]. Resistant soil moisture sensors determine the amount of moisture in the soil by measuring the electrical resistance between two metal strips that are inserted into the soil (metal strips have to be in direct contact with wet soil) and whose moisture is being measured [5]. In order to convert these capacitance or resistor values in an appropriate voltage output signal these sensors are connected to appropriate electrical circuits.

The principle of operation itself implies that the sensors are previously calibrated. Calibration means the formation of a relationship between the output signal and soil moisture. This dependence serves to determine the soil moisture based on the measured voltage. In working with these sensors, a supply voltage of 5V was used, while the output voltage was measured using an Arduino board and a computer, and then was converted into soil moisture using the calibration curves.

Water content or soil moisture w , is defined as the ratio between the mass of water m_w and the mass of dry soil m_d , usually expressed as a percentage, and can be represented by the expression:

$$w = \frac{m_w}{m_d} = \frac{(m_s - m_d)}{m_d} (x100) [\%] \quad (1)$$

Where the quantities represent: w – soil moisture, m_s – mass of wet soil, m_w – mass of water, m_d – mass of dry soil.

Instead of expressing soil moisture by its standard definition given in equation (1), the volume content of water could be used. It is denoted with θ and defined by equation (2) as follows [3]:

$$\theta = \left(\frac{m_s - m_d}{m_d} \right) \cdot \frac{\rho_{d,s}}{\rho_w} \left[\frac{\text{cm}^3}{\text{cm}^3} \right] \quad (2)$$

Where $\rho_{d,s}$ represents density of dry soil and ρ_w the density of water.

3. CALIBRATION OF SOIL MOISTURE SENSORS

Calibration is a common procedure used to form a functional relationship between output signal (voltage) and soil moisture and in such a way form the calibration curve. This dependence serves to determine the soil moisture based on the known voltage. This function is usually linear, or a polynomial to a certain degree. During this test, the volume content of water was determined based on equation (2).

For the calibration procedure in this research, the following equipment was required:

- Sensors to be tested (in this case 2 capacitive and 2 resistive types soil moisture sensors),
- *Arduino UNO* board (hardware),
- Graduated container,
- Water measuring cup,
- Scale with high precision (precision 10^{-4} g),
- Furnace for drying soil samples.

Two soil samples were used, namely the gravel sample (non-homogeneous) and the sand sample (homogeneous). The gravel sample had a grain size of 0 - 16 mm, while the sand had a grain size of 0 - 2 mm. The granulometric curves of soil samples are presented in Figure 2.

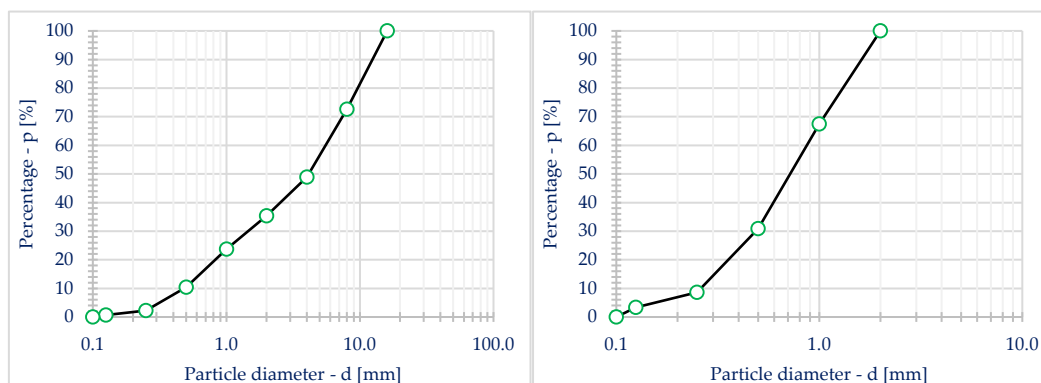

Figure 2. *Granulometric curve the gravel (left) and sand (right)*

The calibration procedure included the following:

- After taking a soil sample, it is dried in an oven at a temperature of 105°C until achieving a constant mass. Because the water evaporated from the sample and the sample is completely dry, so its soil moisture is zero.
- Dried the sample, it is necessary to cool it to room temperature of about 20°C, and then pour it into a graduated container (special care is needed to prevent the moisture from surrounding air to enter the sample).
- Mass of the dried sample together with the mass of the graduated container was measured. Because the mass of empty graduated container is known, by subtracting those two masses, the mass of the dry sample soil is obtained.
- In the soil sample formed in this way, a sensor is installed and the signals are read on the computer screen.
- Then a certain amount (mass) of water is added and measured together with the mass of the sample and the mass of the graduated container.
- Is necessary to homogenize the sample, by manual mixing of the sample until complete homogeneity, and output signal stabilization.
- In performed tests, the volume of water added to the sample was about 20 ml (this was 5% water content).
- The output voltage was registered on the computer.
- Next, the procedure from step 5: adding water to the sample, measuring the mass of the wet sample, and reading the output voltage, for several soil moisture content.

The soil samples after the drying process, and removing water from the soil and presented in Figure 3.



Figure 3. Samples used for experiment, gravel (left) and sand (right)

The amount of water added to the sample depends on the mass of the sample used during the test. In conducting this experiment, the goal was to determine 9 to 10 measuring points, so that the soil moisture reaches about 30%.

The sensors are numbered, during calibration for easier comparison of results, as follows:

- Capacitive Soil Moisture Sensor (DF Robot Electronics) - Sensor 1,
- Resistive Hygrometer Detection Module (ShenZhen HaiWang Sensor Co.LTD) - Sensor 2,
- Resistive Soil Moisture Sensor (Think Robotics) - Sensor 3,
- Capacitive Soil Moisture Sensor Vegetronix VH400 (Vegetronix) - Sensor 4

4. DESCRIPTION OF THE EXPERIMENT

After the calibration of the sensors, the experiment was started. The experimental setup consists of two containers connected by pipes. One container contains a dry soil sample with two inserted sensors of the same type (Vegetronix VH400), and the second one contains water. For the achieved piezometric head difference ($H=40\text{cm}$), it was possible for water to flow towards the sample. After the water passes through the sample and rises above the surfaces of the soil sample, the water container is lowered abruptly so that the direction of flow is reversed with the same piezometric head difference. Soil moisture changes were measured by the sensors during this experiment. To better illustrate the experimental setup, the Figure 4 shows the phases of the experiment.

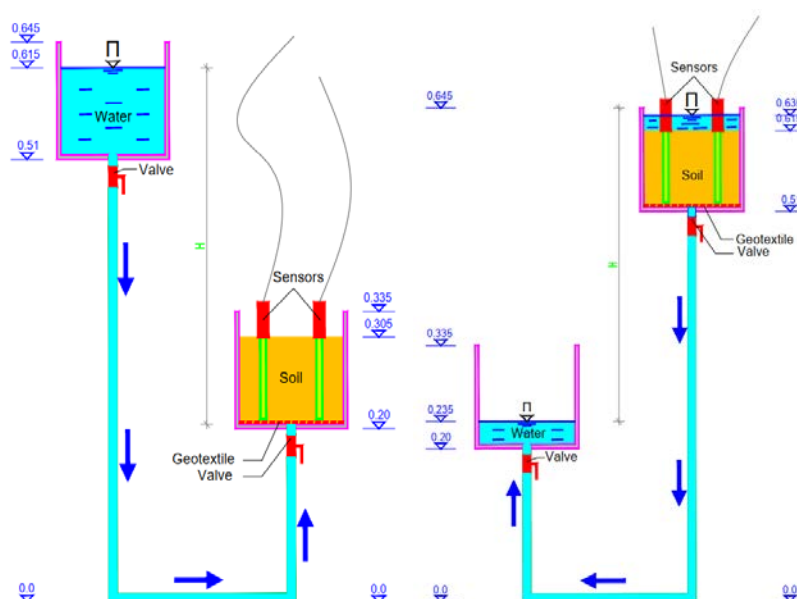

Figure 4. Experiment setup and its phases A - raising the wet front in a sample (left) and phase B - lowering the wet front in a sample (right)

The previously presented experiment is similar to the Darcy apparatus, but the main difference is that it measures the change in moisture of the soil in real time using sensors. During the experiment, a constant amount (1.5 liters) or water volume is used.

5. SENSOR CALIBRATION RESULTS

The calibration of sensors included all previously described procedures in Section 3. The calibrated curves were determined as a dependence of the volumetric moisture content versus $1/U$ ratio i.e. the inverse of Output voltage U . They are presented for all investigated sensors in Table 1, for the gravel sample. In the table in a third column the root mean square deviation value (RMSE) is presented too. In Table 2 are presented calibrated curves for sand samples.

Table 1. Dependences of the output voltage and water volume content for the tested sensors in the gravel sample

Sensor	Equation	RMSE	No. Eq.
Sensor 1	$\theta = 2.0543 \cdot \frac{1}{U} - 0.386$	0.080	(3)
Sensor 2	$\theta = 1.2769 \cdot \frac{1}{U} - 0.2069$	0.071	(4)
Sensor 3	$\theta = -6.2496 \cdot \frac{1}{U^2} + 5.0144 \cdot \frac{1}{U} - 0.7399$	0.037	(5)
Sensor 4	$\theta = 0.077 \cdot \frac{1}{U^2} - 0.3316 \cdot \frac{1}{U} + 0.3777$	0.012	(6)

Table 2. Obtained dependences of the output voltage and water volume content for the tested sensors in the sand sample

Sensor	Equation	RMSE	No. Eq.
Sensor 1	$\theta = 0.9556 \cdot \frac{1}{U} - 0.1657$	0.031	(7)
Sensor 2	$\theta = -11.404 \cdot \frac{1}{U^2} + 7.4953 \cdot \frac{1}{U} - 0.987$	0.164	(8)
Sensor 3	$\theta = 1.2095 \cdot \frac{1}{U} - 0.1752$	0.020	(9)
Sensor 4	$\theta = 0.0808 \cdot \frac{1}{U^2} - 0.3655 \cdot \frac{1}{U} + 0.4833$	0.018	(10)

Functional dependencies are calculated with a criteria to obtain the highest possible coefficient of determination. The coefficient of determination for all tested sensors is greater than 0.9. The graphs in Figures 5, 6, 7 and 8 show the calibration curves that were formed after testing the sensors.

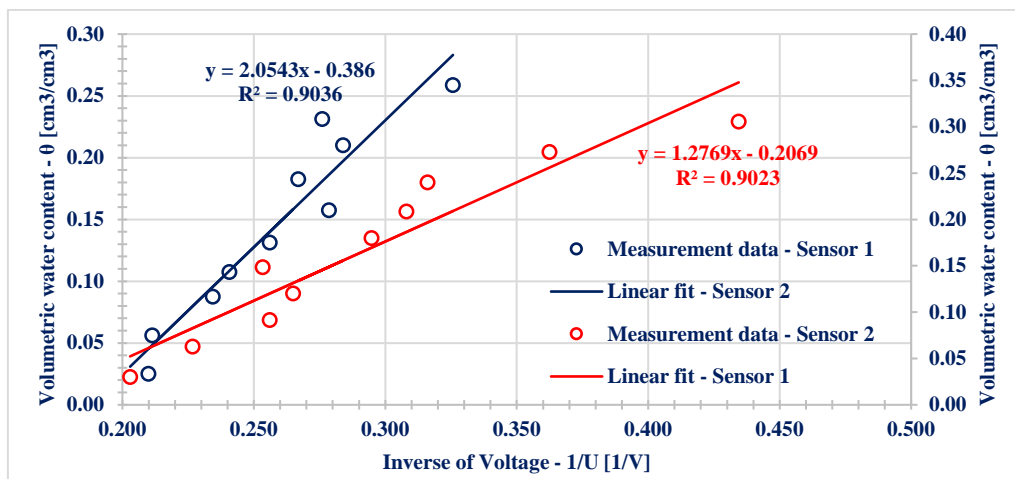

Figure 5. Dependence between water content and inverse voltage for Sensor 1 and Sensor 2 in the gravel soil

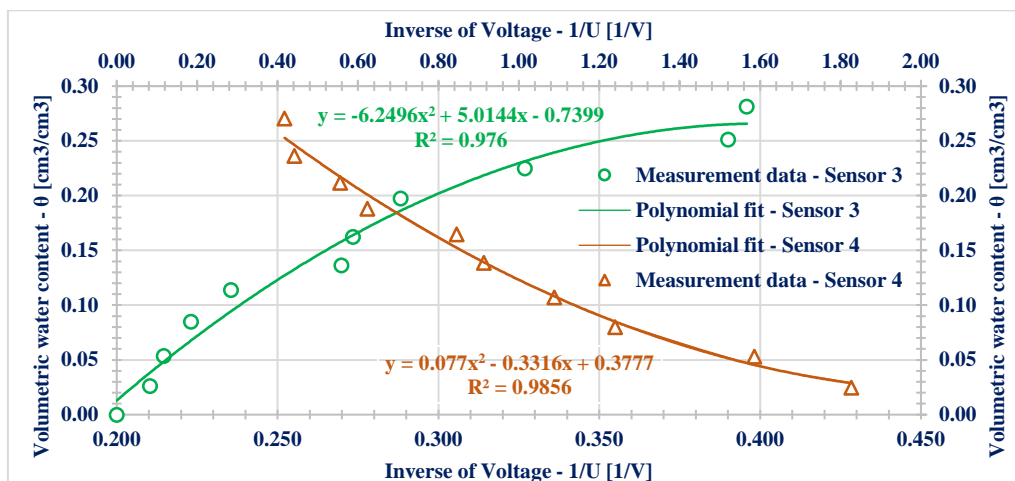

Figure 6. Dependence between water content and inverse voltage for Sensor 3 and Sensor 4 in the gravel soil

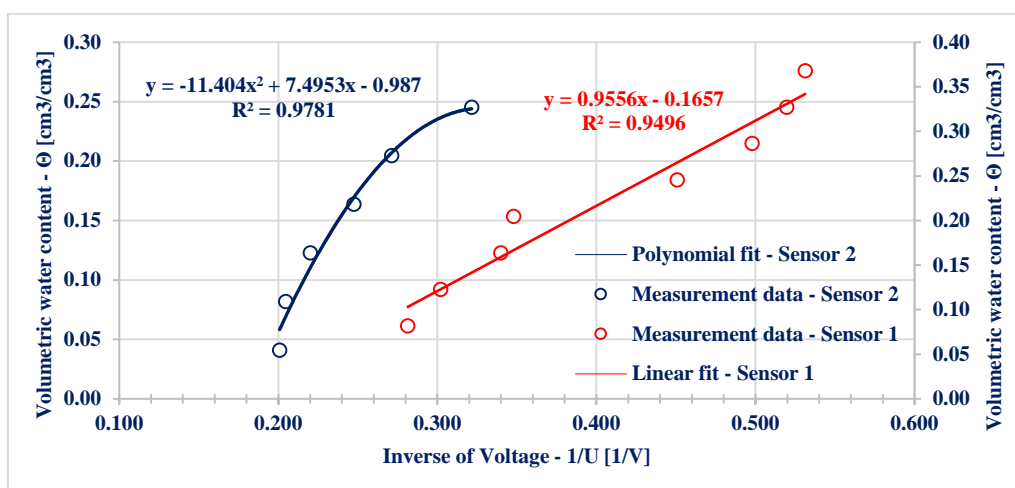

Figure 7. Dependence between water content and inverse voltage for Sensor 1 and Sensor 2 in the sand soil

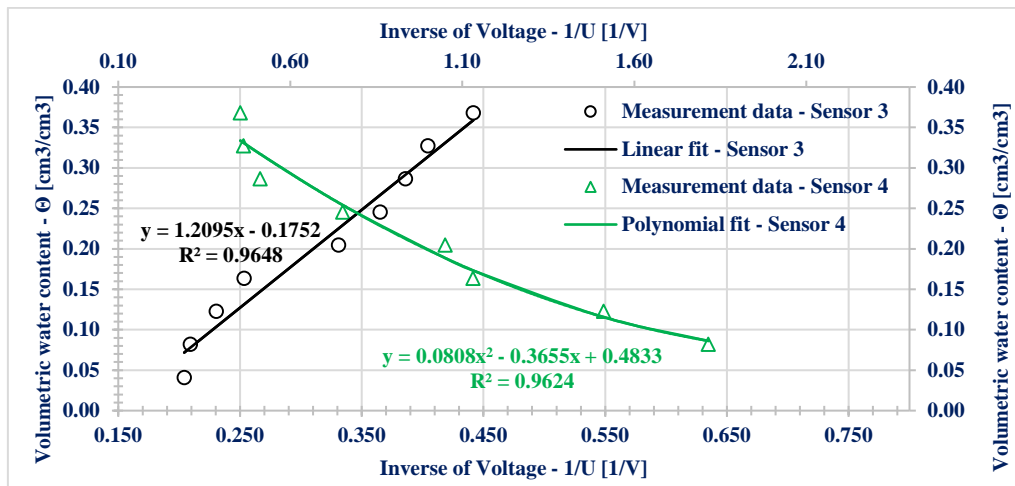

Figure 8. Dependence between water content and inverse voltage for Sensor 3 and Sensor 4 in the sand soil

6. EXPERIMENTAL RESULTS

After calibrating the sensors, the previously described experiment was established and performed. Two *Vegetronix VH400* sensors (Sensor 4a and Sensor 4b) were used to conduct the experiment. This type of moisture sensor is often used in agriculture, as it is described in papers [6], [8].

The final result of the experiment is measuring the change in soil moisture in real time, during the movement of the wet front through the soil sample. Soil moisture values were determined on the basis of calibration curves. In Figure 9 the soil moisture change during the experiment for gravel sample is presented. The photograph of a gravel soil sample during rising the wet front is presented in Fig. 10.

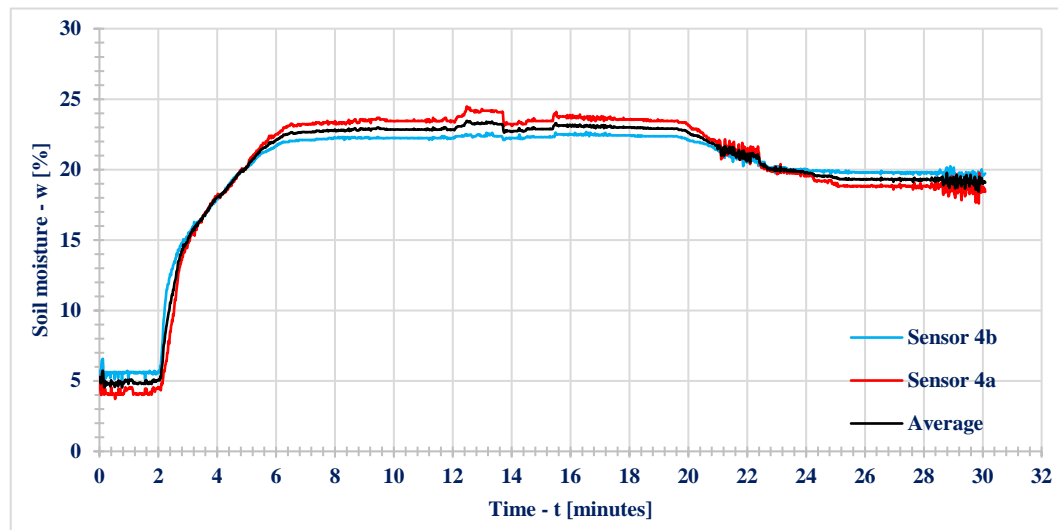

Figure 9. Soil moisture measurement results during the experiment on the gravel soil

Based on the obtained soil moisture measurements during the experiment with the two sensors (denoted as 4a and 4b), a certain difference in measured values can be noticed, but the error was not more than 1%. At the end of the experiment, both sensors showed the same value of soil moisture, which was about 19%.



Figure 10. Phase of the experiment during the movement of the wet front

The experiment was repeated with the sand sample. The results are shown in Figure 11.

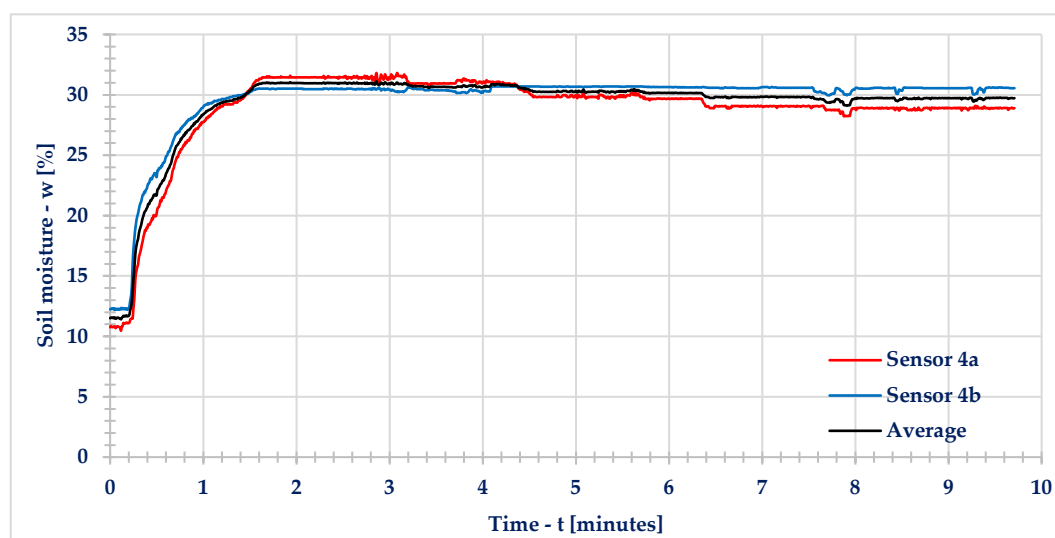

Figure 11. Soil moisture measurement results during the experiment on the sand soil

Comparing the experiments with two types of sand samples, it was clear that the wet front moved much faster through the sand sample than in the gravel sample. After lowering the head water elevation, in the second phase of the experiment, the soil moisture of the sample remained fairly constant even after water came out of the soil sample. Because it takes a time for the soil moisture to significantly change, the experiment was stopped at a soil moisture values about 30%.

Figure 12 shows the movement of the wet front during the experiment on sand soil.



Figure 12. Phase of the experiment during the movement of the wet front

7. DISCUSSION OF RESULTS

In this paper, soil moisture sensors were examined, their calibration was made on the basis of known sample's soil moisture, and the possibilities of their use in the teaching process of hydraulic engineering was investigated. Calibration curves between soil moisture and sensor output signal were formed for two types of soil moisture sensors, resistive and capacitive. Used sensors were relatively cheap, with uncompensated response for different types of soils and clay content. Because of that, each sensor had to be individually calibrated with used soil.

The obtained calibration curves for non-homogeneous and homogeneous soil samples (Figures 5 to 8), for used range of soil moistures (from 0 – 35%) were linear and quadratic polynomial functions (to be more precise, the full-range output of all sensors is quadratic, but certain sensors in limited range of soil moisture can be considered as with linear output). A high coefficient of determination was obtained (>0.9), for all dependencies during sensor testing. It was noticed that the capacitive sensors are more accurate than resistive and have a lower value of the root mean square error, which can be seen in Table 1 and 2.

An experiment for investigating the change of soil moisture of the sample during the movement of the wet front in the sample was performed using two capacitive *Vegetronix VH400* sensors. The conducted experiment aimed at examining the possibility of using soil moisture sensors in the teaching of Hydraulic Engineering and performing the similar experiments for students' practical work. *Arduino UNO* board is proved to be reliable hardware for testing sensors. Due to its relatively low cost it can be used for connection of different types of sensors during experimental exercises. During the experiments, measured data were transferred directly to the computer, but additional local memory can be added to the Arduino, allowing field measurements.

Based on a large number of researches and the performed calibrations, the noticeable advantage has been given to capacitive sensors, as reliable sensors for measuring soil moisture. Also, among them the *Vegetronix VH400* sensor is mostly recommended to be used for irrigation purposes in agriculture especially for control and regulation of irrigation systems.

The conducted experiment proved a concept that it is possible to have a convenient, relatively simple and low cost way to perform measurements of soil moisture in the teaching process of Hydraulic Engineering. From a practical point of view, it is very simple to measure soil moisture using described capacitive sensors connected to an Arduino board and at the same time it is useful for students to gain practical knowledge about it.

8. CONCLUSION

This work described testing soil moisture sensors, using an *Arduino UNO* board and an *Arduino IDE* software. Two capacitive sensors and two resistive sensors were used for testing. The tests were performed on a gravel and sand sample, according to the procedure previously described in the sensor calibration section.

The formed calibration curves are valid only for the tested soil samples. Also, it is recommended to perform sensor tests with other soil types and to compare them with the formed calibration curves. It is better that the sample of soil material used for calibration have uniform granulometric composition, in order to achieve the best possible homogeneity of the wet sample after mixing. In this way, a better reading on the sensors is achieved, the output voltage is stable, which is also the manufacturer's recommendation. When reading the sensor output voltage using the *Arduino UNO* program, it is recommended that the sensor should be inserted into the soil to a certain depth in order to read a representative signal value. If the sensor is inserted too deep, a higher than real value of the output signal is observed. The capacitive soil moisture sensor can take some time to equalize and give steady reading and it is necessary to wait approximately one minute after the sensor settles to a given value [3].

With the help of investigated sensors, it is possible to organize practical exercises for the teaching of hydraulic engineering. Capacitive soil moisture sensors can be used for slow time-varying measurements, especially in real time measurement of soil moisture changing processes in a range from 0 to 30%. These relatively inexpensive sensors as well as the *Arduino UNO* board available on the market can give reliable results in such types of the experiments.

LITERATURE

- [1] M. Makismović, "Mehanika tla", Univerzitet u Beogradu, Građevinski fakultet Beograd, 1995,
- [2] B. Radičević, Đ. Vukić, Đ. Ercegović, M. Oljača, "Mjerenje vlažnosti tla", Poljoprivredna tehnika, broj 4, decembar 2008, str 25 - 36, UDK:336.142,
- [3] J. Hrisko, "Capacitive Soil Moisture Sensor Theory, Calibration, and Testing," no. July, 2020, doi: 10.13140/RG.2.2.36214.83522.
- [4] Arduino For Beginners, www.Arduino.com, vol. 4, no. 2, pp. 457–463, 2018,
- [5] D. Stanoković, "Fizičko tehnička mjerenja - senzori" Univerzitet u Beogradu, Beograd 1997,
- [6] Murtiningrum, Ngadisih, F. A. Rizqi, and M. I. Ulumuddin, "Irrigation volume calculation based on soil wetting pattern in trickle irrigation," IOP Conf. Ser. Earth Environ. Sci., vol. 365, no. 1, 2019, doi: 10.1088/1755-1315/365/1/012010,
- [7] <https://www.arduino.cc/en/software>,
- [8] <http://www.cheapvegetablegardener.com/how-to-use-vegetronix-soil-moisture>,
- [9] <https://www.ardumotive.com/soil-hygrometer-module-en.html>



Marina Latinović Krndija, University of Banja Luka, marina.latinovic@aggf.unibl.org

Dejana Dujaković, GIM-TEST d.o.o. Banja Luka, dujakovic@gim-test.com

Marko Popović, University of Belgrade, mare381@gmail.com

Gordana Broćeta, University of Banja Luka, gordana.broceta@aggf.unibl.org

Anđelko Cumbo, University of Banja Luka, andjelko.cumbo@aggf.unibl.org

DYNAMIC AMPLIFICATION FACTOR OF ROAD BRIDGES – ANALYTICAL AND EXPERIMENTAL FINDINGS

Abstract

This paper discusses the problem of theoretical and experimental determination of dynamic factors of road bridges. Various parameters influencing the dynamic behavior of bridges are briefly described and a review of regulations in this field is given. Also, an example of the numerical determination of the dynamic amplification factor on a specific bridge structure using dynamic *time history* analysis in SAP2000 software is presented. Some established methods for the experimental control of the design dynamic amplification on real structures are given, as well as a data and analysis of experimentally obtained results on a series of concrete bridges on the Banja Luka-Doboј highway.

Keywords: dynamic amplification factor, road bridges, time history, experimental analysis

ДИНАМИЧКИ КОЕФИЦИЈЕНТ ДРУМСКИХ МОСТОВА – НУМЕРИЧКА И ЕКСПЕРИМЕНТАЛНА ИСТРАЖИВАЊА

Сажетак

У раду је разматрана проблематика теоријског и експерименталног одређивања динамичког коефицијента мостовских конструкција. Укратко су описани различити параметри који утичу на динамичко понашање мостова и дат је осврт на важеће прописе у овој области. Такође, даје се примјер нумеричког одређивања динамичког коефицијента на конкретној мостовској конструкцији примјеном динамичке *time history* анализе у програму SAP2000. Дат је опис неких устаљених начина експерименталне контроле пројектног динамичког коефицијента на реалним конструкцијама, као и приказ и анализа резултата мјерења на серији бетонских мостова на аутопуту Бања Лука-Добој.

Кључне ријечи: динамички коефицијент, друмски мостови, time history, експериментална анализа

1. INTRODUCTION

As a part of roads, bridges are primarily exposed to impacts caused by vehicle movement. In long term, if not considered, these impacts would not lead directly to the damage or failure of structural elements, but they would cause degradation and reduced durability. So, to design economical and lasting structures of future bridges, but also to economically rehabilitate existing bridges, i.e. to estimate their real carrying capacity, in terms of accepting the current traffic load, it is important to understand the dynamic interaction of the bridge structure and the vehicles crossing the bridge.

The dynamic amplification factor – DAF, can be defined as an increase of the design load due to the effects of the interaction of the bridge and the vehicles, or as the relationship between the observed maximum total effect - U_d and static effect - U_s :

$$DAF=U_d/U_s, \quad (1)$$

The effects observed are mainly displacements and deformations of certain points of the structure. These effects can be easily experimentally determined on a specific structure, using displacement sensors, measuring tapes, or accelerometers, and thus compared with the expected theoretical results.

This paper briefly describes the various factors influencing the dynamic behavior of bridges and also gives a brief review of current domestic regulations which define a dynamic increase of a design load. Furthermore, a numerical example of determining DAF on a simplified finite element bridge model defined in software SAP2000 is presented, where a comparison of the obtained values determined at different vehicle speeds, and a comparison with the values from the regulations is performed. Finally, a description of some established methods for experimental determination of DAF on real structures is given, as well as a review and analysis of experimentally obtained DAFs on a series of reinforced concrete bridges on the Banja Luka - Dobojski highway.

2. IMACT PARAMETERS ON DYNAMIC AMPLIFICATION

The dynamic response of one bridge to different vehicles can be quite different, so as the dynamic response of similar bridges to the same vehicle crossing at the same speed. In general, the increase in the response of the structure due to dynamic loading can be induced by the bridge characteristics or by the characteristics of the vehicle crossing the bridge.

When determining the maximum DAF, in some cases, certain combinations of dominant factors are critical, such as a specific bridge structure and corresponding critical speed of vehicle crossing, or a certain heavy vehicles combined with specific road roughness index.

2.1. VEHICLE CHARACTERISTICS WHICH INDUCE AMPLIFICATION EFFECTS

2.1.1. Vehicle speed

The critical speed of a vehicle, i.e. the one at which the greatest increase of the observed relevant effect occurs, is different for different bridge structures. The effect on the structure does not increase with increasing vehicle speed, as might be intuitively expected. In many cases, the dynamic factor is higher at higher vehicle speeds, however, this relation is not linear [1-4].

The value of the critical speed of a typical vehicle for bridge structures which are most often encountered in practice varies a lot. For reinforced concrete bridges with shorter spans (5-15 m), the critical speed, in the range of expected traffic vehicles and speeds in traffic, generally ranges from 40 to 80 km/h, but these values can be even lower [1].

2.1.2. Vehicle weight and damping system

In general, the dynamic amplification on real structures decreases with increasing vehicle weight, as the inertial forces are higher [5].

However, in combination with some other characteristics, the weight can greatly contribute to the increase of DAF. For example, a higher weight at the rough bridge surface will give a larger DAF. Also, if vehicle axles are without damping, it will produce high DAFs, while softer axles, give lower factors and good load distribution. [6-9]

2.1.3. Number and distance between vehicles

The Monte Carlo method, used in statistics to determine the probability of different outcomes in the process, is most often used to define the probable load on bridges. Using this method and traffic data for a certain section, it is possible to determine the critical, most unfavorable cases that can occur during the operation of the specific bridge. Dynamic analysis can be performed for several critical cases, however, the greatest critical static load case may not give the greatest dynamic effects.

In the case of short to medium span bridges (20-30 m), the critical traffic load usually consists of two heavy trucks meeting in the middle of the bridge span, however, each bridge structure is unique, and a critical case cannot be easily predicted in terms of number vehicles, axle weights, and axle spacing. [5]

2.2. IMPACTS OF STRUCTURAL CHARACTERISTICS ON AMPLIFICATION EFFECTS

2.2.1. Bridge frequency impact

As emphasized in the relevant regulations, when determining DAF, the span of the bridge has a large impact, which is reflected in the value of the natural frequency. Also, the weight of the bridge affects its frequency, the heavier the bridge, the lower the dynamic amplification. Besides inertia, a larger cross-sectional area of the load-bearing elements of the structure reduces the dynamic impact, since the stiffness of the structure is increased, which gives higher natural frequencies.

The DAF is significantly influenced by the ratio of vehicle speed and bridge frequency [6,9-10].

2.2.2. Bridge damping impact

In general, the damping value significantly affects the intensity of the dynamic factor. As the damping level in the structure decreases, the dynamic factor increases.

As the structure is assumed to work in the elastic region, damping can be modelled as *internal viscous damping*, which occurs due to the viscosity of the material, and which is easy to consider in the numerical models.

2.2.3. Bridge surface roughness impact

The impact of this parameter largely depends on the span of the bridge. In general rougher road surfaces produce larger dynamic effects during the crossing of vehicles. The roughness of the bridge surface affects the dynamic amplification to the greatest extent on shorter bridges, i.e. those with higher stiffness, having short natural oscillation periods. [9-12]

3. DYNAMIC AMPLIFICATION FACTOR IN APPLICABLE DOMESTIC REGULATIONS

Many current regulations, in general, do not require dynamic analysis when designing the bridge structure. Instead, dynamic effects caused by vehicle-bridge interaction are accounted for by multiplying the static live load by DAF.

DAF for a specific bridge structure is conditioned by many parameters, and in most regulations, many important characteristics of bridges and vehicles are neglected, so the calculations in this way are quite conservative. [13,14]

In this geographic region, in the field of analysis of the impact on bridges, EN 1991-2 (2003): *Eurocode 1: Actions on structures – Part 2: Traffic load on bridges* and the *Rulebook on technical norms for determining the load on bridges* are in use.

According to *Eurocode 1: Actions on structures – Part 2*, dynamic factors are already included in different types of design load for road bridges. Vehicle models already have a "built-in" dynamic factor. These "built-in" amplifications are determined by the range and shape of the influence line, which depends on the lanes of the vehicle model [15,16].

Figure 1 shows the dynamic amplification factor as given in the *Eurocode 1* as a function of bridge length and the number of lanes.

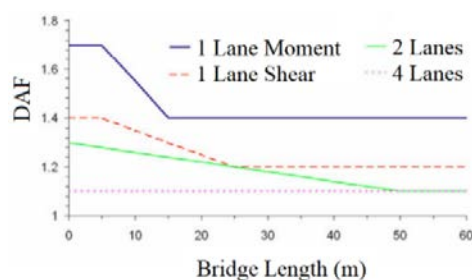

Figure 1. DAF built-in in the Eurocode 1 [16]

According to the *Rulebook on technical norms for determining the load on bridges*, all loads that are entered into the calculation of structural parts of the bridge, except for the end and middle pillars,

must be multiplied with the dynamic factor K_d . The dynamic factor for road bridges is a function of the span length of the bridge, and it is defined by the expression:

$$K_d = 1,4 - 0,008L \geq 1, \quad (2)$$

where L (m) is the relevant span length. In the case of continuous beams, L is the bridge span in which the typical vehicle is located. When transmitting a force in two or more directions, L is the smallest span. [17]

According to the formula above, in the case of the relevant span length greater than or equal to 50 m, factor K_d has a value of 1, neglecting the dynamic effects due to traffic load, which is not in the line with the experimental and theoretical considerations.

In summary, according to the *Eurocode*, the dynamic factor is a function of the span length and shape of the influence line, while according to the *Rulebook on technical standards for determining the load on bridges*, the dynamic factor is only determined by the span of the load-bearing structure. The values calculated this way are conservative, but mostly on the safety side, although they do not take into account many significant parameters of vehicle and structure.

Parameters such as surface roughness, damping, structure geometry, vehicle speed, and other vehicle characteristics can hardly be generalized and included in regulations.

4. NUMERICAL DETERMINATION OF THE DYNAMIC AMPLIFICATION FACTOR

Analytically, the dynamic equation, i.e. the functional dependence of the velocity and the values of the dynamic factor for a simple beam is given in [2,18].

In the section below, a description of the numerical calculation of the dynamic factor, by performing dynamic analysis in the program SAP2000, is presented.

4.1. NUMERICAL MODEL DATA

In the numerical example presented herein, the analysis of the impact of certain bridge and vehicle parameters was performed on the FE model of a concrete bridge.

The bridge is continuous with three spans, with ranges of 16 m, 20 m, and 16 m, respectively. The main structure consists of 10 prestressed T-girders with a total height of 2,4 m, and an axial distance of 6 m. The concrete slab cast over girders is 25 cm thick. The pillars are of reinforced concrete. This bridge structure type is characteristic on the Banja Luka - Dobojski highway.

Several significant simplifications have been made in the bridge and vehicle models, to clearly see the impact of variable parameters on dynamic amplification. The influences of all variable parameters were observed on a two-dimensional model of the bridge, without considering torsion, and the load was applied in a form of a concentrated force. Vehicle vibration and surface roughness were ignored.

The value of the dynamic factor depending on the speed of load and the load mass was observed on three different bridge models, which differ only in terms of the height of supports, i.e. longitudinal stiffness of the structure, since points 3 and 7 have restricted vertical movement (Figure 2).

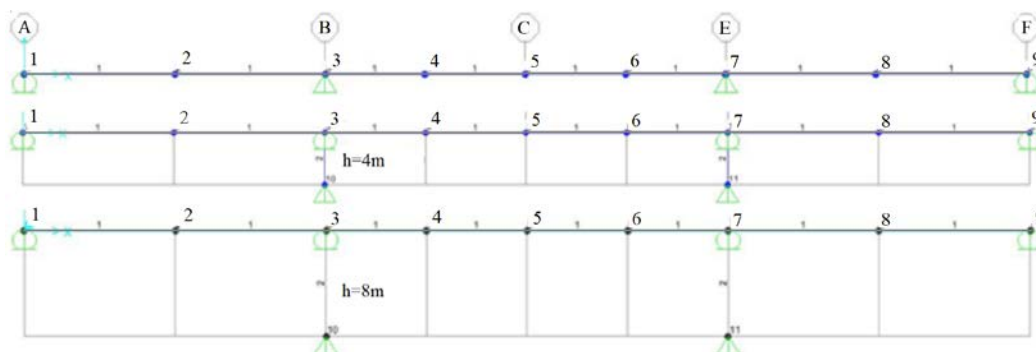

Figure 2. Bridge models: Model 1 - rigid supports, Model 2 - 4 m high supports, Model 3 - 8 m high supports

In the software SAP2000, the method of *Linear Time History Analysis* was performed and the load was applied as moving load. As the model is simple, in *Time History Analysis*, the *Direct Numerical Integration* method, and the *Newmark* method with the coefficient $\beta = 1/4$ were used. Depending on the speed, the time steps are in range from 0.001 to 0.0005 s.

In [2], this method of analysis was compared with the numerical solution, where the deflection of the simple beam was determined by the partial differential equation of motion and the moving load was defined by the *Dirac function*. The agreement of the obtained results was presented in Figure 3.

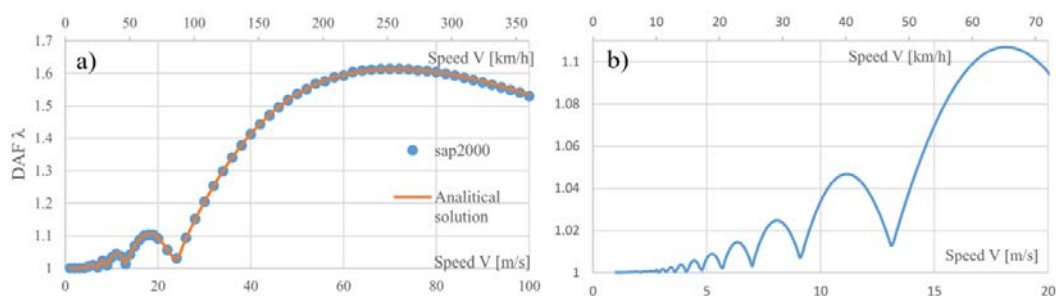

Figure 3. DAF as a function of load speed movement - comparison between numerical solution and analysis in SAP2000 for simple beam: a) time period 0-100s, b) time period 0-20s. [2]

4.2. RESULTS OF THE NUMERICAL ANALYSIS

The analysis showed that at very low speeds, dynamic factor is close to 1, as the dynamic influences are small, and with increasing speeds, its value oscillates, as it depends on the excited oscillation modes.

Figure 4 gives a visual overview of the point deflection in the middle of the bridge span, obtained via the procedure above described, for model 1, with rigid supports, and with variation in mass and velocity of moving point load.

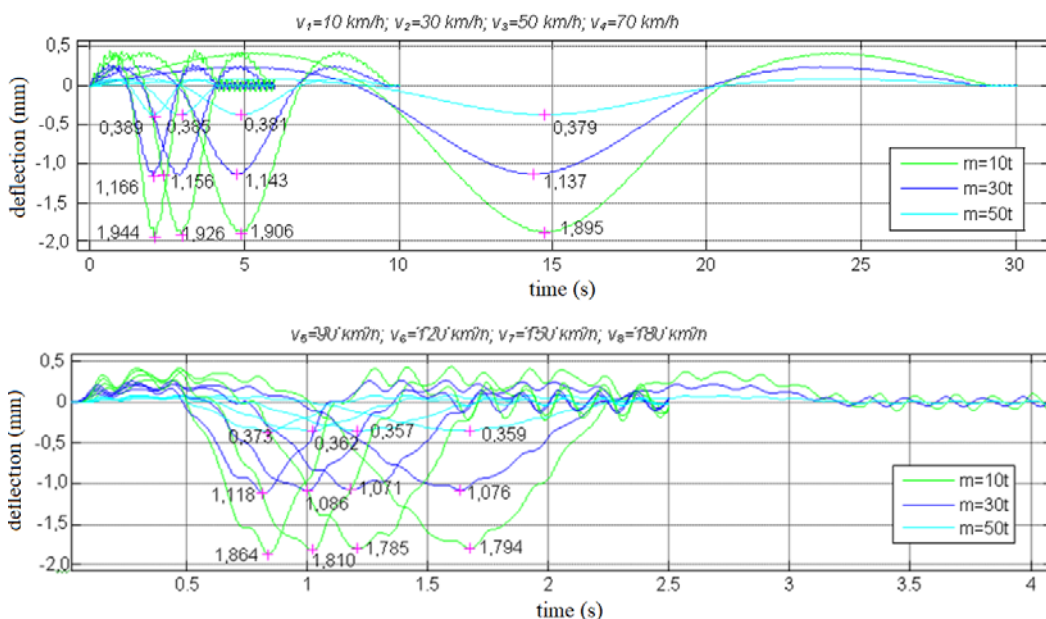

Figure 4. Deflections in the middle of the span at different time intervals for model 1, speeds of 10-180 km/h

Even at close speeds, for example, 160 km/h and 180 km/h, DAF values show significant differences, and they also differ for different models, as presented in Figure 5. The results are shown for unreal vehicle speeds, over 200 km/h, to emphasize the speed impact.

The calculation was repeated for 3 mass values of the point load – 10t, 30t and 50t. It was concluded that, for this case of the two-dimensional model, with even pavement, the load mass does not affect the values of dynamic deflections.

Stated results, obtained with variations of only three parameters – load mass, load speed, and structure longitudinal stiffness (which depends on the height of the columns), indicate problems in the theoretical determination of the dynamic factor in the design stage when performing dynamic analysis, as small differences in the model and vehicle speed can greatly affect the DAF values.

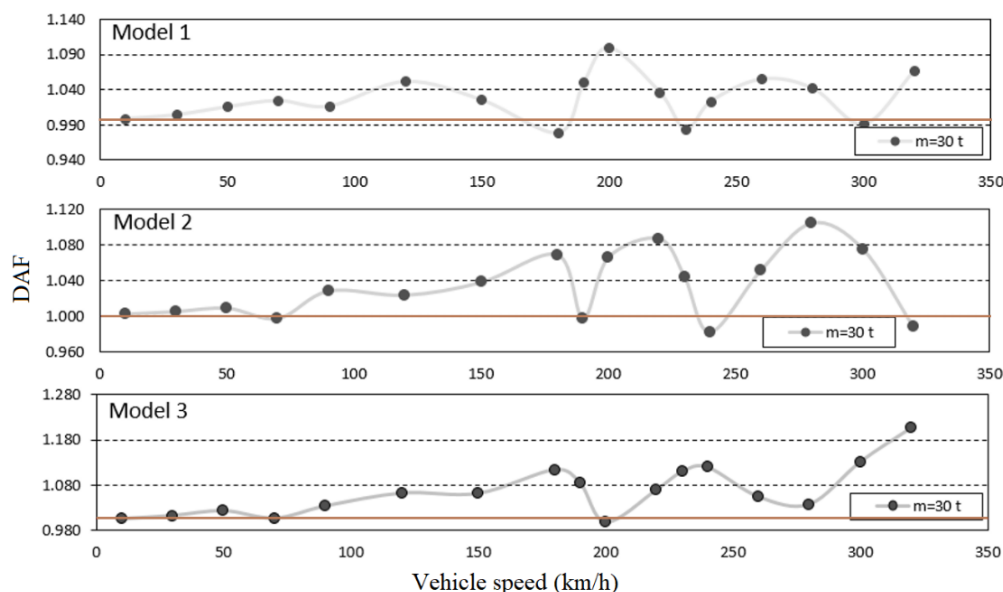

Figure 5. DAF values in relation to vehicle speed

Using the expression (2) defined by the rulebook [17], which does not take into account longitudinal stiffness, or vehicle speed, obtained dynamic factor for the largest span is 1,24. This value is higher than all the values obtained in all three models, at real vehicle speeds. It can be concluded that taking the design value, over the numerical value, in this case, is on the safe side.

If some other parameters were considered in the dynamic analysis, such as surface roughness, this might not be the case.

5. EXPERIMENTAL DETERMINATION OF THE DYNAMIC AMPLIFICATION FACTOR

After the construction or rehabilitation of bridges, it is necessary to perform static and dynamic load testing, to compare with the design data.

The most common parameters that describe the dynamic behavior of a structure are the dynamic factor, natural frequency, and damping. All these parameters can be found experimentally from the structure response diagrams, i.e. by measuring certain quantities on the structure over time.

5.1. METHODS FOR THE DYNAMIC AMPLIFICATION FACTOR EXPERIMENTAL DETERMINATION

Experimentally, the dynamic factor can be obtained in several ways [19-22]. The most reliable way of determining DAF value for a specific bridge is a *full-scale dynamic-testing* under *controlled traffic*.

Depending on the method for measuring the maximum value of the static response, the following expressions can be used [19]:

$$DAF = R_{dyn} / R_{sta} \quad (3)$$

$$DAF = R_{dyn} / R_{sta}^{dyn} \quad (4)$$

$$DAF = R_{dyn} / R_{fil,sta} \quad (5)$$

$$DAF = R_{dyn} / R_{fil,sta}^{dyn} \quad (6)$$

Where following labels are used:

- R_{dyn} – maximum dynamic response,
- R_{sta} – maximum static response obtained by placing the vehicle in the appropriate position, or maximum quasi-static response obtained by driving the vehicle at low speed and recording the maximum value,
- R_{sta}^{dyn} – quasi-static response obtained by driving the load at low speed and recording the value at the corresponding time and location of maximum dynamic response,
- $R_{fil,sta}$ – maximum static response obtained by filtering the measured dynamic response with a low-pass filter to eliminate dynamic signal components (when measuring displacement or

strain in time with digital instruments, dynamic time records contain both static and dynamic component),

- $R_{\text{fil,sta}}^{\text{dyn}}$ – static response obtained by filtering the measured dynamic response with a low-pass filter to eliminate dynamic signal components, which is determined for the point in time when the maximum dynamic response is obtained.

When the filtered response is equal to the quasi-static response, equation (4) corresponds to equation (6), and also equation (3) to equation (5).

The graphical explanation for possible values of static response is provided in Figure 6.

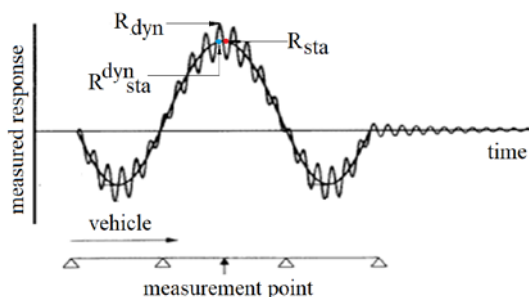

Figure 6. Possible values of static response

When using R_{sta} – the static response obtained in the test load by placing the vehicle in the appropriate position or quasi-static response obtained when a vehicle is passing the bridge at low speed, or $R_{\text{fil,sta}}^{\text{dyn}}$ – the maximum response obtained by filtering the measured dynamic response, smaller values of DAF are obtained. That also means that equations (3) and (5) give smaller DAF, compared to (4) and (6).

So, in the case when a static component is not measured separately but extracted from dynamic time records, recorded displacement or strain amplitude time histories contain both static and dynamic components of the bridge response. Extracting the static component from displacement time histories is performed by filtering techniques, using a low-pass filter which eliminates the dynamic component. The low-pass filter blocks all frequencies lower than the set limit frequency. The eigenfrequency of the bridge is the basis for selecting the cut-off frequency required to perform dynamic record filtering. Therefore, it is preferable to first measure the bridge eigenfrequencies, performing ambient measurements. [20,23]

On the technical side, when determining the dynamic factor, it is important to place the instruments in the appropriate cross-section zone. The middle of the transverse span is recommended, in order to measure effects in the zone of direct impact, and thus avoid an increase of the dynamic amplification, which can occur if measurements are made outside the zone of direct impacts, such as on pedestrian consoles. [19]

During the dynamic testing, the vehicle can cross the flat surface of the bridge at various speeds or it can cross over the installed *obstacle*, i.e. obstacles on the road. Also, the dynamic impact can be measured after *sudden braking*, which is a more common way in practice today, compared to using the obstacles.

Typically, for medium span bridges, the impact is measured when one vehicle passes the bridge, when two vehicles pass one after the other, or when they meet each other.

Mechanical deflection meters, inductive linear displacement sensors or optical devices can be used to measure deflection, and appropriate strain gauges can be used to measure strains.

5.2. EXPERIMENTAL DETERMINATION OF DYNAMIC AMPLIFICATION FACTOR ACCORDING TO THE JUS U.M1.046 STANDARD

According to the standard JUS U.M1.046 - *Testing of bridges with test loads*, it is required to measure the deflection during the load passing over the bridge and to record the speed of passing. It is not required to place an obstacle on the pavement, or to perform sudden braking.

The dynamic behavior of the bridge is considered satisfactory if the measured free vibrations are within the theoretical values, if the dynamic factor is within the limits defined in the main design, and if the vibrations do not create a feeling of discomfort for the users [24].

6. DYNAMIC AMPLIFICATION FACTOR DETERMINATION ON A SERIES OF REINFORCED CONCRETE BRIDGES

During the years 2016 and 2018, the *Institute for Materials and Structures Testing* of the Republic of Srpska performed a series of load tests on the new concrete bridges and overpasses on the Banja Luka-Doboj highway. The load tests were performed following the JUS U.M1.046 standard, which, considering dynamic tests, requires the measurement of vertical deflection in the middle of the span during the load passing over the bridge and observation of possible deformations and review of the general condition of the structure after dynamic testing.

According to the established practice until then, for all dynamic measurements, a 5 cm thick wooden plank was placed on the structure, representing a possible obstacle or unevenness on the pavement.

6.1. BRIDGE STRUCTURES DATA

The tested bridge structures are classified into 4 basic types:

- **Type 1** - structures located on the main road, framed, with one, 9 m long span. Bridge slabs are reinforced concrete 70-80 cm thick, integrated with supporting columns.
- As the bridge structures were separate for different highway directions, measurements were made on a total of 4 structures of 2 bridges.
- **Type 2** - structures located on the main road, framed, with 3 do 5 spans. Bridge slabs are reinforced concrete 70-80 cm thick, integrated with supporting columns.
- As the structures were separate for different highway directions, measurements were made on a total of 11 structures, always in a first span with 12 m length.
- **Type 3** - structures located on the main road, continual, consisting of 10 prefabricated prestressed concrete T-beams, transversal beams at supports, and pavement slab, as a monolithic layer, which is concreted on-site over the upper flanges of the prefabricated T beams. This type of bridge has spans of 15+3x20+15 m.
- Measurements were made on a total of 4 structures, always in the second span, with the length of 20 m.
- **Type 4** – structures located off the main road, continual, with 4 to 6 spans, consisting of prefabricated prestressed concrete T-beams, transversal beams at supports, and pavement slab, as a monolithic layer. Depending on the category of the road passing highway, this type consists of 5-8 T-beams.
- Measurements were performed on medium spans of 20 m length on 13 structures and of 24 m length on 3 structures.

Typical bridges and corresponding cross-sections on the main road (type 2 and 3) and on the side roads (type 4), are shown in Figure 7.

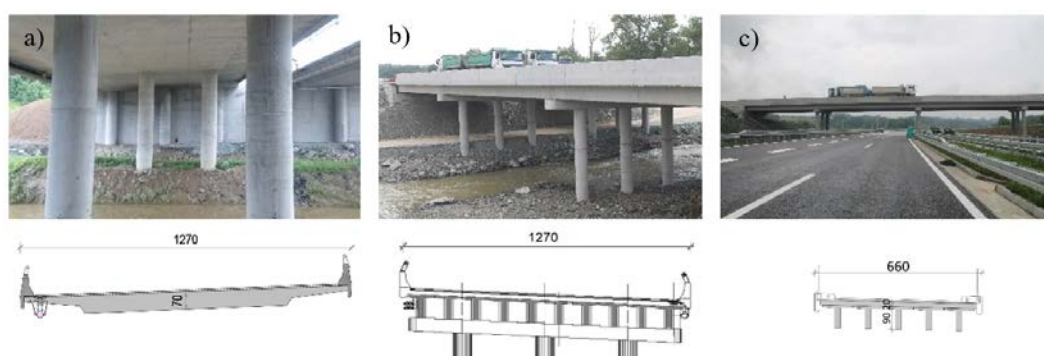

Figure 7. Typical bridges and corresponding cross-sections: a) bridges on the main road - type 2, b) side roads bridges - type 3, c) side roads bridges - type 4.

6.2. MEASURING EQUIPMENT

Devices for measuring dynamic displacements are placed at characteristic locations, i.e. at the locations of maximum deflections, determined by the control static calculation.

Measurements were performed by *HBM half-bridge inductive displacement sensors*, with an accuracy of 0,14% and with measuring range of 40 mm. Some of the measured dynamic factors obtained with inductive displacement sensors were compared with the values obtained by measuring local deformations using „*Hottinger*“ strain gauges of type LY41 50/120, however, these values

were not included in the analysis. All devices were connected to the *HBM MX840A eight-channel universal measuring system* and *HBM CATMAN –EASY data acquisition software*. The sampling frequency when measuring dynamic response was 600 Hz.

6.3. EXPERIMENTAL SETUP

Depending on the load test program, trucks with a total weight of 32 to 38 t were used. The disposition of vehicles used is shown in Figure 8.

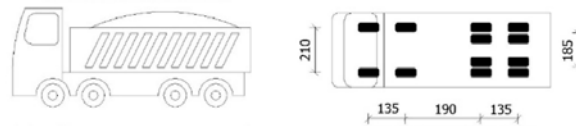

Figure 8. Test load vehicle disposition

To determine dynamic factor, the vehicles were moving at speeds in the range of 40-60 km/h, over a wooden plank with a height of 5 cm, placed at the location of the predicted maximum deflection, also where the measurements were also performed. After conducting the dynamic test and removing the plank, vehicles drove on the same path with a crawling speed of 5-10 km/h.

Deflection in the vertical direction is recorded in a form of a time history. According to Figure 9, at the same location, using the same instrument, the time history signal is recorded for dynamic and maximum quasi-static deflection. Therefore, the DAF is computed through the expression (3).

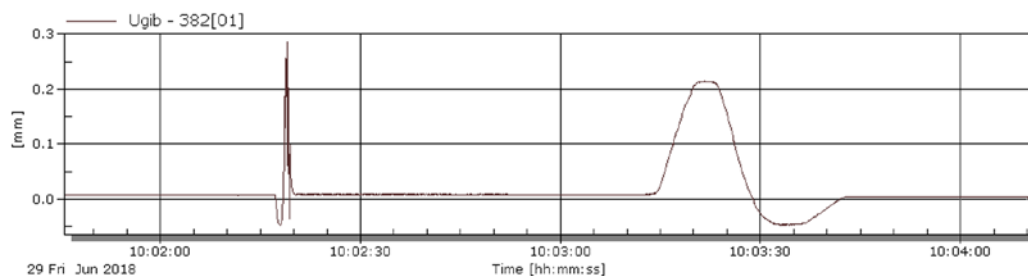

Figure 9. Time history signal example for dynamic and quasi-static deflection

Two instruments were placed within the characteristic cross-section on most structures, thus two measurements were recorded during one test.

Except for dynamic deflections, other relevant parameters which were measured: the speed of the loading vehicles, the temperature of the structure, the ambient air temperature, and weight of the vehicles.

6.4. MEASURING RESULTS AND ANALYSIS

The results of maximum dynamic and quasi static displacements are calculated as the mean value of the obtained measurements, in case of two measurements in one cross section.

Also, as stated, the results were controlled through the values obtained with the strain gauges, if they existed in the appropriate sections. Dynamic factors determined by strain measurements are not presented in this paper, as some studies have shown that factors determined in this way have lower values than those obtained by deflection [19], so it was decided that the measurements used to determine DAF are uniform. Only data obtained through inductive displacement sensors were used. Some characteristic dynamic deflection records are shown in Figure 10.

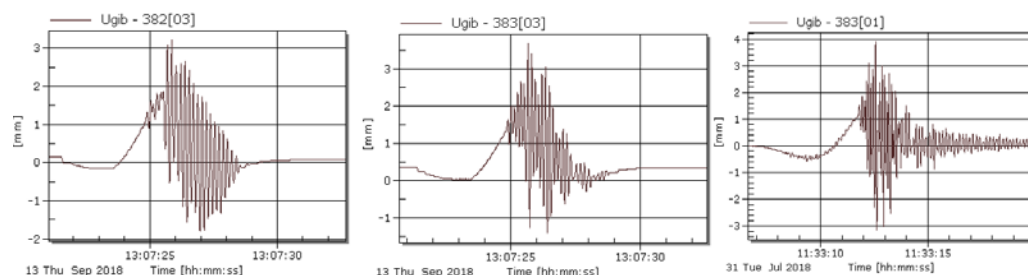

Figure 10. Examples of obtained time history signal for dynamic deflection

The design dynamic factor in the project documentation is calculated through expression (2). The measured dynamic factors show different values, in the range of values from close to 1, to over 2, Figure 11. As can be seen in Figures 11 and 12, the results obtained show a certain dispersion.

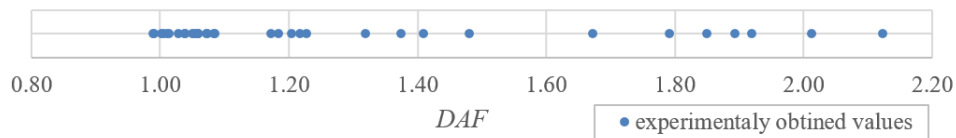

Figure 11. Experimentally obtained values of DAF for all types of structures

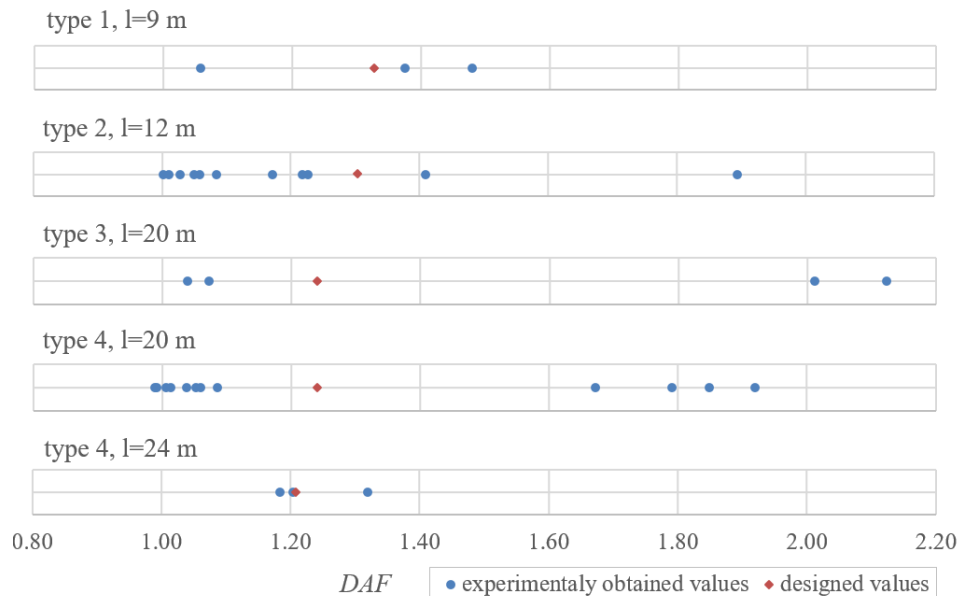

Figure 12. Experimentally obtained values of DAF classified by types of structure

Most of the results obtained experimentally are lower than the design values, however, several results significantly exceed these limits.

Previous experimental research [19,22] have shown that the impact of road surface irregularities on the measured DAF is large, and that, in general, when testing with an obstacle on the road significantly higher values of dynamic factors are obtained. These research also suggest that further analyses are needed on this subject. Experimental tests have shown high DAF values (over 2) in the case of passing vehicles at low speeds (20 km/h) over the plank [10,19]. When the tests are performed by the load passing over the plank, it is not possible to correlate with the numerical values, nor predict behavior under such conditions. Regardless, the plank has been often used in practice, since in this way dynamic behavior is emphasized, and possible unevenness or obstacles on the road are simulated.

Generally, for smaller bridge spans, higher dynamic factors are obtained, which agrees with the expressions defined by the standards, as well as the experimental results [19]. In the research presented herein, there are not many results for small-span bridges (type 1), however, it can be concluded that higher dynamic factors were obtained for bridges with a span of 12 m (type 2), compared to those with a span of 20 m (type 3 and 4).

Some experiments with plank returned dynamic factors with value of 1 and slightly lower than 1 [10], although this is not supported by theoretical considerations. This was the case here for the small number of results, for structure type 4, where values less than 1 were obtained, although the signal sampling frequency was 600 Hz. Similar values were obtained using strain gauges.

For structure type 3, there are 4 test results, determined on 2 bridges of equal span and pavement width. Although these bridge structures are nominally the same, the results show significant deviations, even the tests were performed under the nominally same conditions - the only parameter that varied through the measurements was the speed of the vehicle crossing the obstacle - 40 and 60 km/h, respectively. This occurrence can be explained by differences considering bridge structure, which could be the result of the execution or differences in bearings or supports.

As the weight of the vehicles varied between 32 and 38 t, depending on the bridge structure, and the speed was 40-60 km/h for either weight, conclusions on weight and speed influence cannot be made.

7. CONCLUSIONS

Determination of dynamic amplification factor, either numerically or experimentally, is a rather complex problem. As there are a large number of parameters that affect its value, many are neglected in the regulations, since they are difficult to generalize and include in general equations. The factors defined by the regulations are mainly a function of a small number of parameters (span, influence line), and therefore they are quite conservative.

In a simple dynamic numerical analysis in the SAP2000 software package, it was shown that small variation in the model parameters, in terms of bridge structure longitudinal and bending stiffness, and the speed of the moving load, greatly affects the values of DAF. The value obtained by the expression defined by the rulebook [17], is higher than all the values obtained in numerical analysis, at real speeds, for all three models. It can be concluded that choosing the design value, over the numerical value, in this case, is on the safe side. If some other parameters were considered in the dynamic analysis, such as surface roughness, this might not be the case.

As in the numerical analysis, so in the experimental determination of DAF, there are many parameters to consider, from calibration, position and method of setting measuring instruments, to placing the vehicles in the exact position when measuring both static and dynamic response. All these parameters have great impact on results, thus it is important to perform very precise measurements.

The results obtained by experimental research on a series of concrete bridges on the Banja Luka – Dobož highway show a great dispersion. All results were obtained using a plank. In general, experimental analysis using plank gives larger values of measured DAF. This method cannot show a correlation with the numerical model, in order to make conclusions on the structure response, and has been abandoned in today's practice. To emphasize the dynamic effects, sudden braking is more used nowadays. Even with plank, generally, for smaller bridge spans, higher dynamic factors are obtained, which agrees with the expressions defined by the standards, as well as with the theoretical and experimental findings.

LITERATURE

- [1] S. P. Brady, E. J. O'Brien, and A. Znidarić, "The Effect of Vehicle Velocity on the Dynamic Amplification of a Vehicle crossing a Simply Supported Bridge," *Journal of Bridge Engineering*, vol. 21, no. 2, 2006.
- [2] S. Savatović, R. Salatić, and Z. Mišković, "Vehicle speed influence on the dynamic factor of bridges," *7th International conference - Contemporary achievements in civil engineering*, Subotica, Serbia, 23-24. April 2019, pp 179-188.
- [3] E. Savin, "Dynamic amplification factor and response spectrum for the evaluation of vibrations," *Journal of Sound and Vibration*, vol. 248, no. 2, pp. 267–288, 2001.
- [4] Y. Li, E. O'Brien, and A. González, "The development of a dynamic amplification estimator for bridges with good road profiles", *Journal of Sound and Vibration*, vol. 293, no. 1–2, pp. 125–137, 2006.
- [5] A. González, P. Rattigan, E. J. O'Brien, and C. C. Caprani, "Determination of bridge lifetime dynamic amplification factor using finite element analysis of critical loading scenarios," *Engineering Structures*, vol. 30, pp. 2330–2337, 2008.
- [6] M. F. Green and D. Cebon, "Dynamic interaction between heavy vehicles and highway bridges," *Computers and Structures*, vol. 62, no. 2, pp. 253–264, 1997.
- [7] W. Roberts, "Dynamic Interaction of Vehicles and Bridges." *7th International Symposium on Heavy Vehicle Weights & Dimensions*, Delft, Netherlands, June 16 - 20, 2002, pp. 423–432.
- [8] N. Lu, M. Beer, M. Noori, and Y. Liu, "Lifetime Deflections of Long-Span Bridges under Dynamic and Growing Traffic Loads," *Journal of Bridge Engineering*, vol. 22, no. 11, p. 04017086, 2017.
- [9] I. Paeglite, J. Smirnovs, and A. Paeglitis, "Dynamic Behavior of Pre-stressed Slab Bridges," *Procedia Engineering*, vol. 172, pp. 831–838, 2017.
- [10] I. Paeglite and A. Paeglitis, "The dynamic amplification factor of the bridges in Latvia," *Procedia Engineering*, vol. 57, pp. 851–858, 2013.

- [11] I. Štimac, D. Meštrović, and I. Kožar, "Analiza mostovnih konstrukcija pobuđenih pokretnim opterećenjem," *Građevinar*, vol. 56, pp. 347–353, 2004.
- [12] E. J. O'Brien, Y. Li, and A. González, "Bridge roughness index as an indicator of bridge dynamic amplification." *Computers and Structures*, vol. 84 (12), pp. 759-769, 2006.
- [13] Štimac Grandić, D. Grandić, and R. Mužić, "Određivanje dinamičkog koeficijenta na mostovima," *Elektronički časopis Građevinskog fakulteta Osijek - e-GFOS*, vol. 6, pp. 23–33, 2013.
- [14] L. Deng, Y. Yu, Q. Zou, and C. S. Cai, "State-of-the-Art Review of Dynamic Impact Factors of Highway Bridges," *Journal of Bridge Engineering*, vol. 20, no. 5, p. 04014080, 2015.
- [15] "EN 1991-1-4: Eurocode 1: Actions on structures," vol. 1, no. 2005, 2011.
- [16] H. Bruls, Aloïs, Calgareo, Jean-Armand, Mathieu, "ENV 1991 part 3: the main models of traffic loads on road bridges: background studies." *IABSE Colloquim*, pp. 215–227, 1996.
- [17] "Pravilnik tehničkim normativima za određivanje velicina opterećenja mostova," *Sl. list SFRJ*, br. 1/91, 1991.
- [18] [18]D. Kuchárová and G. Lajčáková, "Moving Load Effect on Concrete Slab," *Procedia Engineering*, vol. 190, pp. 326–333, 2017.
- [19] P. Paultre, O. Chaallal, and J. Proulx, "Bridge dynamics and dynamic amplification factors - a review of analytical and experimental findings," *The Canadian Journal of Civil Engineering*, vol. 19, no. 2, pp. 260–278, 1992.
- [20] J. Yang, Y. Bai, X. Yang, and Y. Feng, "Dynamic Amplification Factor Measuring of T-girder Bridges," *Key Engineering Materials*, vol. 540, pp. 29–36, 2013.
- [21] D. Janev, T. Arangelovski, D. Nakov, and G. Marakovski, "Methods for determination of the DAF from moving loads on RC bridges," *18-ti Međunaroden Simpozium na Društvo na Građevinske Konstruktere na Makedonija, Ohrid, Makedonija, 2-5. Oktobar 2019*, pp. 868-877.
- [22] O. Chaallal and M. Shahawy, *Experimental evaluation of the dynamic amplification factor for bridge performance*, Department of Construction Engineering, University of Quebec, Report No. ETS.DRSR.98.1, Jun 1998.
- [23] J. Benčat, and R. Kohár, "Bridges Subjected to Dynamic Loading", *Bridge Engineering*, London, United Kingdom: IntechOpen, 2018, [Online]. Available: <https://www.intechopen.com/chapters/59297>, doi: 10.5772/intechopen.73193
- [24] "SRPS U.M1.046:1985 - Ispitivanje mostova probnim opterećenjem", 1985.



Snežana Ilić, Institut IMS, snezana.ilic@institutims.rs

Mirjana Malešev, University of Novi Sad, miram@uns.ac.rs

Milica Mirković Marjanović, Institut IMS, milica.mirkovic@institutims.rs

Aleksandar Kijanović, Institut IMS, aleksandar.kijanovic@institutims.rs

DETERMINATION OF VENTILATION HEAT LOSSES THROUGH BUILDING ENVELOPE – A CASE STUDY

Abstract

In this paper the experimental procedure for the determination of ventilation heat losses across building envelopes has been shown. The alternative name for this method is Blower Door Test or Fan Pressurization method. This text is a user manual for the determination of ventilation heat losses and parameters which is used to describe the air permeability of buildings. The experiment examination was performed at the office with old and after with new windows. The results were compared, and a significant contribution of new windows was shown.

Keywords: Blower door test; Experimental determination of ventilation heat losses; air change rate

ЕКСПЕРИМЕНТАЛНА ПРОЦЕДУРА ЗА ОДРЕЂИВАЊЕ ВЕНТИЛАЦИОНИХ ГУБИТАКА У ЗГРАДАМА

Сажетак

У раду је приказана експериментална процедура за одређивање вентилационих губитака кроз грађевински омотач. Ова процедура се у пракси назива и Метода повећања притиска помоћу вентилатора. У тексту је детаљно објашњен поступак мерења, као и приказ мерне опреме. Такође је у раду приказано мерење на конкретном објекту. Мерење је извршено у две фазе. Прва фаза мерења је извршена на просторији са старом столаријом. Друга фаза мерења је извршена након промене столарије. Сврха мерења је одређивање побољшања заптивености унутар испитне просторије променом застареле столарије.

Кључне ријечи: Blower door тест, експериментално одређивање вентилационих губитака, број измена ваздуха, ISO 9972

1. INTRODUCTION

Buildings lose heat by ventilation and infiltration. This is caused because of the movement of heated air from inside the building into its surroundings and its replacement by cold air from outside. Ventilation heat losses means the controllable air movement through windows, doors, extractor fans, mechanical ventilation systems. Infiltration heat losses refer to the air flow through gaps in the fabric of the building. The advantage of ventilation is in removing moisture in the roof space or under suspended ground floors, from kitchens, toilets, as well as to provide fresh air. It is necessary to provide ventilation in buildings, but it is required to limit heat losses to save energy and protect environment. A number of works [6-8], deals with heat loss of buildings.

Heat gains and heat losses of buildings mostly depend on the thermal and physical properties of construction elements and materials. 25% of total energy required for heating and cooling is caused by heat losses or heat gains through the building windows. For detailed engineering calculations of heating or cooling loads of building it is important to know the information of the thermal transmittance through windows and doors [1]. This type of losses is heat loss by heat transmission through the building envelope. The other group of heat losses is ventilation heat losses through gaps between leaf and frame of doors and windows, wall penetrations caused by cables, pipes, etc. This type of losses could be determined experimentally for rooms or entire buildings. The experimental procedure has been given in International Standard ISO 9972 [2]. This paper has shown a short version of this standard and it could be used as a user manual for the determination of air change rate and other engineering parameters, like as uncertainty of the blower door method.

The air change rate is a measure of air tightness quality of rooms or an entire building. This parameter could be determined using two modes: pressurization and depressurization. Similar for both methods is making a constant pressure difference between examined room and outer space. On this constant pressure difference could be measured volume flow on the fan measuring system. This volume flow is actually the air leakage rate across the building envelope area. Air leakage rate per inertial volume is the definition of air change rate.

The rulebook [3] prescribes the standards according laboratory should measure air changes. The allowed number of air changes according to JUS U.J5.100 is 2 h^{-1} , while the standard SRPS EN ISO 9972 does not prescribe this value. The reason why the European standard does not have this type of data is that each country has prescribed the number of air changes.

In this paper, the two experiments were performed at the inside door of the examined office. The first experiment was the determination of air change rate at the office with old wooden windows, then windows were replaced with new PVC windows and the second experiment was performed. The experimental procedures were performed to examine the decrease of ventilation heat losses across building envelopes.

2. TEST APPARATUS AND TECHNICAL REQUIREMENTS OF EQUIPMENT

There are many ways to achieve positive or negative pressure inside the building or room. Figure 1. is shown the most common test apparatus which consists of the pressure-measuring device (1), temperature-measuring device (2), airflow measuring system (3), fan control (4), and fan (5). The pressure-measuring device is capable of measuring pressure difference in the range of 0 Pa to 100 Pa, with an accuracy of ± 1 Pa. Temperature-measuring device should be capable of measuring temperatures to an accuracy of 0,5 K. Air flow rate measuring device is capable of measurement with an accuracy of ± 7 % of the reading.

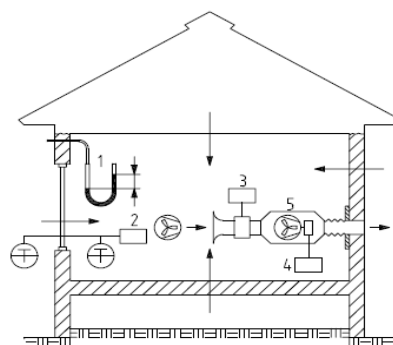

Figure 1. Test apparatus [2]

3. MEASUREMENT PROCEDURE

The examination exists of two measuring modes: depressurization and pressurization. With those methods, we can measure the air leakage of building envelopes. Measurement accuracy depends on several factors: ambient conditions, instrumentation, and apparatus. The results of the depressurization method are even larger than that of the pressurization method. However, when air-tightness in the building is high, the test results of both methods are almost equal. For modern buildings with PVC windows this is more often. PVC windows and doors have higher resistance to air permeability.

The proper measurement depends on meteorological conditions. These conditions could influence on zero-flow pressure difference. The zero-flow pressure difference is measured when the fan was turned off. This pressure difference is corrected on actual measured pressure during the measurement process. If the product of the indoor/outdoor air temperature difference, expressed in Kelvin, multiplied by the height (vertical position of the room), expressed in meters, of the building or measured part of the building gives a result greater than 250 mK, it is unlikely that a satisfactory zero-flow pressure difference can be obtained [2]. If the wind speed near the ground exceeds 3 m/s or the meteorological wind speed exceeds 6 m/s or reaches 3 on the Beaufort scale (used for measuring wind speed), it is unlikely that a satisfactory zero-flow pressure difference can be obtained. [2] It is the most widely used system to measure wind speed today [2], [3].

In standard [2] are defined three types of test methods depending on the purpose.

Air permeability measurement is performed inside a completely finished envelope of the building or part of the building (apartment, office). In standard [2] are defined three types of test methods depending on the purpose. There are three methods for the preparation of the building measurements. The first method applies the test of the building in use (for example clean rooms). While using this type of method the ventilation openings for natural ventilation, openings for mechanical ventilation or air conditioning (only intermittent use), windows, doors, trapdoors in envelopes and openings not intended for ventilation should be closed, and openings for the whole building mechanical ventilation or air conditioning should be sealed.

The second method refers to the building envelope and it is used to compare different construction techniques. While using this method the ventilation openings for natural ventilation, openings for whole building mechanical ventilation or air conditioning, openings for mechanical ventilation or air conditioning (only intermittent use), openings not intended for ventilation should be sealed and windows, doors, trapdoors in envelope and openings should be closed.

The third method is used when we have the building for a specific purpose, for compliance with the air-tightness specification of a building code or standard. While using this method the ventilation openings for natural ventilation, openings for whole building mechanical ventilation or air conditioning, openings for mechanical ventilation or air conditioning (only intermittent use), openings not intended for ventilation and windows, doors, trapdoors in envelope and openings could be closed, sealed, or open as specific.

Before starting the test it is necessary to connect the air-moving equipment to the building envelope using an adequate door, window, or vent opening (to eliminate leakage).

It is recommended that indoor/outdoor pressure difference shall be measured at the lowest floor level of the building envelope. It is necessary to pay attention that the air moving equipment does not influence interior and exterior pressure taps. We must pay special attention to the exterior pressure tap, because of the influence of the effect of dynamic pressure. This problem can be solved by fitting a T-pipe or connecting it to a perforated box. During sunny days we need to protect the tubing from the large temperature differences if we want to pressure measuring to be valid.

4. MEASUREMENT PROCESS

It is recommended to make two types of measurements: pressurization and depressurization. In the beginning, it is necessary to record the wind speed or force by Beaufort scale based on observation. Afterward, it is needed to determine the zero-flow pressure difference. For the zero-flow pressure difference, the reference value is outside. At the beginning of the test temporarily cover the opening of the air moving equipment and connect pressure measuring device to measure inside-outside pressure difference. [2] Minimum 10 values should be recorded throughout for over at least 30 s. After collecting the data it is necessary to calculate the average of the positive values of zero-flow pressure difference (Δp_{01+}), the average of the negative values of zero-flow pressure difference (Δp_{01-}), and the average of all values of zero-flow pressure difference (Δp_{01}). This procedure shall be

repeated at the end of the test and calculate Δp_{02+} , Δp_{02-} , Δp_{02} . If the absolute value of Δp_{01+} , Δp_{01-} , Δp_{02+} , Δp_{02-} is higher than 5 Pa, the test shall be declared not valid.

Pressure difference measurement starts with turning on the air-moving equipment. Measurement of airflow rate and indoor and outdoor pressure difference is obtained. Pressure difference shall be increased no more than 10 Pa. The value for the lowest pressure difference shall be 10 ± 3 Pa, or five times the value of the zero-flow pressure difference (Δp_0), whichever is greater. For the highest pressure difference, it is recommended the value of 50 Pa, but it would be best to achieve pressure difference from 100 Pa.

5. TECHNICAL DESCRIPTION OF USED BLOWER DOOR EQUIPMENT

For experimental analysis of room, air permeability is used MINNEAPOLIS BLOWER DOOR [5]. The Blower Door consists of a nylon door panel which is mounted on an adjustable aluminum door frame. The Blower Door Fan is an axial fan and it consists of a pressure difference device and flow rings. The fan could be controlled manually using frequency regulation of motor speed. Depending on the volume of a room, the size of the flow ring shall be chosen. When the testing room is with higher volume it is necessary to use larger rings (example ring A in Figure 2). An adequate ring is that one that can measure pressure difference in measuring intervals of 10Pa to 100 Pa.

The first step of measuring is to maintain a constant pressure difference of 50Pa with one installed ring. If this pressure difference is not possible, an additional ring is necessary. The next figure is shown an axial fan with flow rings. On the top of the fan shall be installed pressure difference gauge. In these experiments are used DG 700 Pressure Difference gauge, Figure 2, and figure on the right side. This gauge measures pressure difference in the inlet of the axial fan, Figure 3. Pressure gauge calculates volume flow depends on pressure difference and used flow rings.



Figure 2. Axial Fan with flow rings and pressure difference gauge [5]



Figure 3. Flow sensor [5]

6. EXPERIMENTAL RESULTS OF BLOWER DOOR TEST

This chapter shows the results of air permeability tests of the office when old, wooden windows were replaced with new, PVC windows, and new PVC windows. The tested office has dimensions 4.5 x 2.47 x 3.75m. The calculated volume of the office is 41.7 m³. The height of the room is 5m (second floor of the building). First measurement was done in the office with old wooden windows. After that, new PVC windows were installed in place of the old ones. Second measurement was done thereafter setting-up new windows.

Before replacement windows, on the envelope of the room were installed wooden windows and two doors. PVC door is the outside door, while wooden door is the inside door of the office. The air conditioning system is sealed and heating was turned off. Tests are performed in pressure difference range between -10 Pa to -100 Pa (depressurization mode). For measuring was chosen warm day with low wind speed. Wind speed and the outside temperature were measured by a hot-wire device. Outside temperature was 303 K, the wind speed was less than 3m/s, and volume flow was not corrected by wind speed corrections. Office temperature was constant at 297 K.

Tests were performed on the flow ring C, and ten measuring points were taken. Before air permeability examination was performed measuring of zero pressure difference. The bias pressure of the room was about -4Pa. In the next table are shown measured data.

Table 1. Experimental data of office with wooden windows

Δp_m [Pa]	10.2	19.9	30.2	40.2	50.1	60.0	70.0	80.3	90.0	100.2
q_r [m ³ h ⁻¹]	122.0	181.0	205.0	247.0	281.0	305.0	345.0	367.0	406.0	425.0

All of the data in table 1 are plotted in Figure 4. The equation on the figure is determined using the trend line option in *Microsoft Excel*. This equation is useful for designers of HVAC systems, to determine ventilation losses across building envelopes. The most useful information of air permeability across building envelope is air change rate at a reference pressure of 50Pa. The calculated airflow across the building envelope is 294.2m³/h. Air change rate at a reference pressure difference of 50Pa is 7.05h⁻¹.

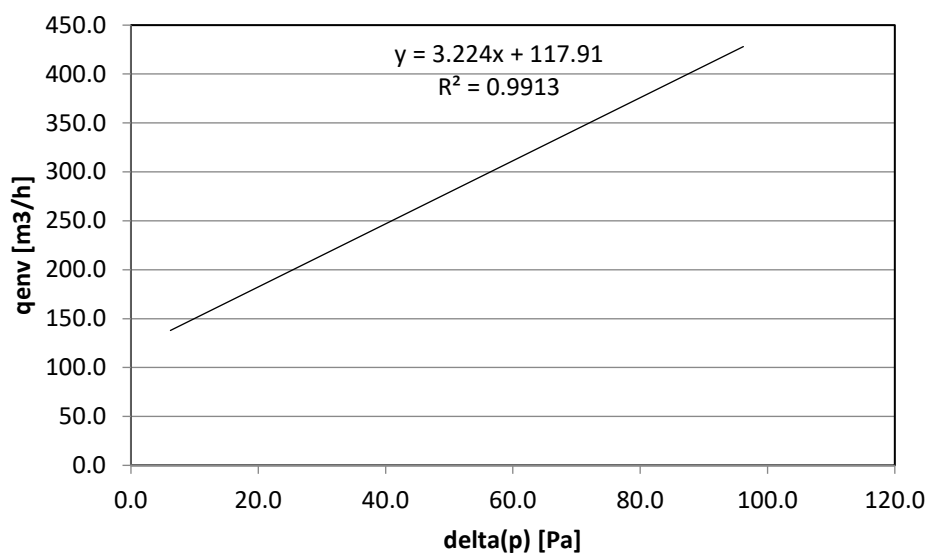

Figure 4. Plotted experimental data of the office with wooden windows

The second measurement was done after replacing wooden with PVC windows. These tests were performed because it is necessary to check the thermal improvement of the office. On the envelope of the room are installed PVC windows and two doors. PVC door is the outside door, while wooden door is the inside door of the office. The procedure was identical to the previous examination. Outside temperature was 305 K, wind speed was less than 2 m/s, and volume flow was not corrected by wind speed corrections. Office temperature was constant at 298 K.

Tests were performed on the flow ring C, and ten measuring points were taken. Before air permeability examination was performed measuring of zero pressure difference. The bias pressure of the room was about -3 Pa. In the next table are shown measured data.

Table 2. Experimental data of office with PVC windows

Δp_m [Pa]	10.4	20.0	30.5	40.2	49.9	59.9	69.9	80.5	89.8	100.3
q_r [m ³ h ⁻¹]	61.0	110.0	147.0	180.0	208.0	240.0	269.0	300.0	332.0	352.0

All of the data in table 1 are plotted in Figure 4. The equation on the figure is determined using the trend line option in *Microsoft Excel*. This equation is useful for designers of HVAC systems, to determine ventilation losses across building envelopes. The most useful information of air permeability across building envelope is air change rate at a reference pressure. The calculated airflow across the building envelope is 217.3 m³/h. Air change rate at a reference pressure difference of 50 Pa is 5.21 h⁻¹.

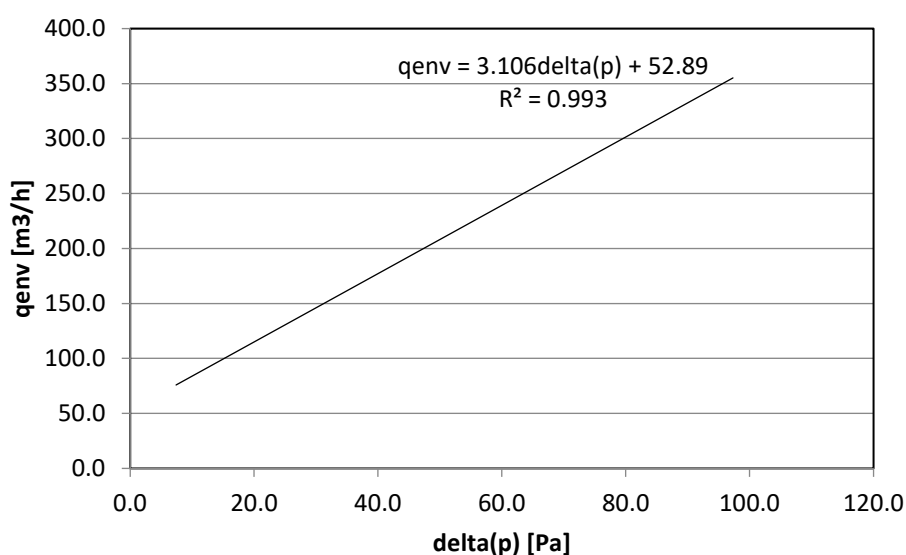

Figure 5. Plotted experimental data of the office with PVC windows

7. DISCUSSION AND CONCLUSION

In this paper, experimental procedure for the determination of air permeability in buildings was shown. This procedure has to be performed to determine ventilation heat losses across building envelopes before and after reparation of windows and doors. Quality of room air tightness is the air change rate at a reference pressure. Using windows and doors with higher thermal performance could decrease the cost of heating and cooling. The experimental procedure was performed on the same room with old and after, with new windows. The experiment has shown that ventilation heat losses were reduced by more than 25%.

ACKNOWLEDGEMENTS

This paper has been supported by the Ministry of Education, science and technological development through the project no. 451-03-9/2021-14/200156: „Innovative scientific and artistic research from the FTS activity”.

The work reported in this paper is a part of the investigation supported by the Ministry of Education, Science and Technological Development, Republic of Serbia, Contract No. 451-03-9/2021-14/200012. This support is gratefully acknowledged.

LITERATURE

- [1] A. Kijanović, N. Rudonja, M. Gojak, "Experimental and numerical examination of fire thermal transmittance of the PVC window frame of six cavities with double glazed glass filled with argon", in *50. Međunarodni Kongres i Izložba o KGH*, 2019, pp. 329-334.
- [2] ISO 9972 Thermal performance of buildings – Determination of air permeability of buildings – Fan Pressurization method, ISO, 2015.
- [3] Rulebook on energy efficiency of buildings, (Official Gazette, number 61/2011)
- [4] "Beauford Wind Scale." Internet: <https://www.spc.noaa.gov/faq/tornado/beaufort.html> [Feb. 24, 2022]
- [5] "Blower Door User Manual." Internet: <https://www.ivytools.com/v/technical-documents/Minneapolis-Blower-Door-Manual.pdf> [Feb. 24, 2022]
- [6] D. Brazhanova, V. Stoyak, M. Ibragimova, A. Terziev, "Methodology for determination of heat losses from infiltration and ventilation and heat gains from people in overall energy balance of the building", in *25th Scientific Conference on Power Engineering and Power Machines (PEPM'2020)*, 2020, 10 pages
- [7] D. Suszanowicz, "Optimisation of heat loss through ventilation for residential buildings", in *Recent Advances in Urban Ventilation Assessment and Flow Modelling*, MDPI, 2019, pp. 148-157.
- [8] F. Flourentzou, S. Pantet, "Theoretical and real ventilation heat losses and energy performance in low energy buildings", EPFL Innovation Park, Lausanne, Switzerland



Siniša Vučenović, University of Banja Luka, sinisa.vucenovic@pmf.unibl.org

Nataša Šetrajčić, Kopering konsalting, natasa.setrajcic@yahoo.com

Nikola Vojnović, University of Novi Sad, nikola.vojnovic@ftn.uns.ac.rs

Jovan Šetrajčić, Academy of Sciences and Arts of Republic of Srpska, jovan.setrajcic@gmail.com

Snježana Dupljanin, University of Banja Luka, snjezana.dupljanin@pmf.unibl.org

THE HEAT BALANCE FOR EXTERNAL COMPOSITE WALLS

Abstract

One of the first steps in reducing energy consumption for heating and cooling buildings is developing of thermal insulation envelope of building. Nowadays contemporary walls have constructions composed from different layers – which make composite structures. We have developed model of the heat balance and based on that model simulation that could analyze and determine the heat balance and temperature distribution inside the buildings in dependence from external conditions and temperature distribution inside the walls and on their boundaries between different layers. All cases represents passive isolation, where the heat balance depend only on materials characteristics, on their heat transfer coefficients, thermal conductance properties and thickness of used materials. For various combinations of today available construction and insulating materials, we have calculated the overall coefficients of heat transmission. Our calculations confirm advantage of usage hollow bricks instead solid bricks, and placing insulation layers on the outer side of walls. Furthermore, those simulations will serve as test for the wider project of the dynamic heat flow experiments in general structures and among them in nanostructures as well.

Keywords: the heat balance equation, composite walls, passive isolation.

ТОПЛОТНИ БАЛАНС ЗА СПОЉАШЊЕ КОМПОЗИТНЕ ЗИДОВЕ

Сажетак

Један од првих корака у смањењу потрошње енергије за загријавање и хлађење зграда је развој топлотне изолације код омотача зграде. Данашњи савремени зидови имају конструкцију која је сачињена од различитих слојева – који чине структуру композита. Развили смо модел топлотног баланса и на основу тог модела симулацију која анализира и одређује топлотн баланс и температурну дистрибуцију унутар зграда у зависности од спољашњих услова и температурне дистрибуције унутар зидова и на граничним слојевима између различитих слојева. Сви случајеви представљају пасивну изолацију, гдје топлотни баланс зависи само од карактеристика материјала, од коефицијената пролаза топлоте, топлотне проводности и дебљине кориштених материјала. За различите комбинације конструктивних и изолационих материјала, који су данас доступни, израчунали смо укупне коефицијенте пролаза топлоте. Наши прорачуни потврђују предност кориштења шупљих умјесто пуних цигли, као и потребу постављања изолационих материјала на спољашњој страни зидова. Надаље, симулације ће служити као тест за шири пројекат експерименталне динамике топлотног протока, како у структурама у општем случају, такои у наноструктурама.

Кључне ријечи: једначина топлотног баланса, композитни зидови, пасивна изолација.

1. INTRODUCTION

Until the end of the twentieth century, not much attention was paid to the thermal properties of the outer walls. The walls were mostly built according to the old empirical rules, and in our country, the general rule was that thickness of the outer wall must be 1.5 solid bricks [1]. If the wall was not sufficiently thermally insulated, the rooms were heated more, and as energy sources (wood, coal, electricity, and gas) were not expensive, the thermal properties of the walls were not relevant for sizing the outer walls. Due to the energy crisis, the need to save energy for the heating has become very relevant [2]. The average building in Serbia and the Republic of Srpska consumes 200 to 280 kWh/m² of energy per year, standard insulated below 100 kWh/m², while modern low-energy houses consume 40 kWh/m², and passive 15 kWh/m² and less. In recent years, the debate on the importance of energy savings has intensified, due to the need to reduce CO₂ emissions into the atmosphere, which is considered one of the main causes of the current problem - global warming. In addition, there are very important hygienic and health reasons, due to which this phenomenon is given great attention. For example, when heat is dissipated in large quantities, the surface of the wall becomes damp (corners of the room) and mold forms. Molds cause allergic effects and emit toxins [3], which is very harmful to human health.

Thermal insulation of buildings has multiple consequences [4]. It should provide the comfort of the interior space - not only in terms of providing optimal temperature, but also in terms of also calming unpleasant air currents that occur due to temperature differences (from the facade wall to the interior and from the floor to the ceiling). Then, it should provide more permanent protection - after the basic investment and installation, to perform its role for a longer period, without requiring additional maintenance and power costs, unlike air conditioning systems. Thermal insulation has a dual role - depending on where the building is located, the season or time of day, it protects it from winter or heat, doing so 24 hours per day, through the whole year. Finally, thermal insulation should ensure energy efficiency - to contribute in reduction of the cost of energy used, but also to have a positive impact on the environment. After the construction of a thermally insulated house, the savings in energy consumption can be over 60%, so the primary investment pay off in a few years. However, efforts are still being made to find ways and new materials to increase efficiency and reduce investment costs. The motive for researching these problems lies in finding optimization methods and software solutions that will provide a clear analysis of different combinations of commercially available insulation materials, as well as their thicknesses, depending on microclimatic conditions and economic parameters. The goal is to recommend an adequate solution for the construction of walls in buildings - especially civil engineering (max. 1 to 2 floors), which are most common and numerous in villages and peripheral areas of larger settlements and cities.

Additionally, but not least, is the fact that the minimization and introduction of nanostructures in building materials is becoming a reality. In addition to a large number of questions about the potential hygienic and health danger of embedding nanoparticles in buildings, there is a real need to incorporate nanostructures into materials, because nanostructures showed completely different properties when compared to the same substances made in macro sizes. In addition to the necessary experiments in real conditions, it is necessary to analyze and previously develop computer simulations of heat flow through such structures. Finally, after complete elaboration and test-verification, this software could be used to test the thermodynamic and hydrological properties of new materials, based on modern nanostructures.

2. HEAT CONDUCTION

Three basic ways of heat transfer are known [3,5-9]. First is conduction, where heat transfer occurs from one body to another in the direction of heat flux movement, i.e. from a place of higher temperature to a place of lower temperature. The second way is by heat flow (convection), which takes place through the movement of individual parts of the body or the environment in which the bodies are located. The third way of heat transfer is by radiation, which is carried out by electromagnetic waves. Although all three mentioned ways of heat transfer can take place at the same time, one of them is always dominant. In construction, the dominant one is conduction and in this case - we talk about the conduction of heat through the wall.

However, there are many real cases in which radiative processes, and especially convective processes (which are especially related to the processes of heat convection in the air layers), not only cannot be ignored - but also become dominant. These cases are especially important for phenomena that are closely related to the condensation of water vapor on the walls. In this paper, however, we

will limit ourselves to heat conduction, with the intention of including other processes in further research.

2.1. PHYSICS BACKGROUND OF HEAT CONDUCTION

The solution to this problem comes down to considering the flow of heat through a conductive rod placed between two heat reservoirs located at temperatures T_1 and T_2 , as shown in Figure 1.

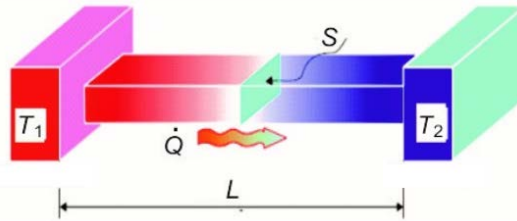

Figure 1. Heat conduction through the conductive rod between two reservoirs at temperatures: $T_1 > T_2$

It has been established that the amount of heat exchanged in a unit of time (heat transfer rate) is a function (difference) of the temperature of the given heat reservoirs, geometry and other relevant properties of the conducting rod:

$$\dot{Q} \equiv \frac{dQ}{dt} = -\lambda S \frac{dT}{dx} = K \times S \frac{dT}{dx}, \quad (1)$$

where λ is the coefficient of thermal conductivity, and K is the coefficient of heat transfer - an important property of insulating materials. For simplicity, the heat transfer rate per unit area is defined - as follows:

$$\dot{q} \equiv \frac{\dot{Q}}{S} = -\lambda \frac{dT}{dx} \quad (2)$$

and is called the heat flux per unit time in $[W/m^2]$. This is a one-dimensional form of Fourier's law of thermal conductivity [6-9]. It should be emphasized that Fourier's law in the general form is the equation expressed in vector form that shows the heat transfer in real 3D conditions. However, of special interest is the heat flow normally to the wall surface (heat lost or heat gain), so in this case the use of a one-dimensional Fourier's law equation is justified.

2.2. STATIONARY QUASI-ONE-DIMENSIONAL HEAT CONDUCTION

Suppose that we have a thin layer of thickness dx within the isothermal surface (Figure 2).

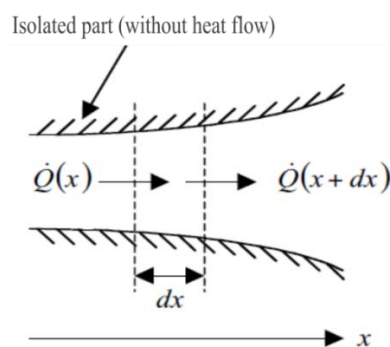

Figure 2. Stationary heat conduction through the homogeneous material normally to the isothermal surface

As the process is stationary [6-9], the input rate of heat transfer must be equal to the output rate. Therefore, the rate of heat transfer that passes through a layer of thickness dx can be given as a sum of power series:

$$\dot{Q}(x + dx) = \dot{Q}(x) + \left. \frac{d\dot{Q}}{dx} \right|_x dx + \left. \frac{1}{2!} \frac{d^2\dot{Q}}{dx^2} \right|_x (dx)^2 + \dots \quad (3)$$

Neglecting the members of the higher ranks, and comparing with the initial definition, it follows:

$$S \frac{d\lambda}{dx} \frac{dT}{dx} + \lambda \frac{dS}{dx} \frac{dT}{dx} + S\lambda \frac{d^2T}{dx^2} = 0. \quad (4)$$

This equation describes the temperature field for quasi-one-dimensional stationary thermal conduction. It was analyzed in the case of a homogeneous material, and this was necessary for further analysis of a single-layer flat homogeneous wall, and later for a multi-layer one.

2.3. HEAT CONDUCTION THROUGH A SINGLE LAYERED WALL

The derived equation can now be applied to the calculation of heat conduction through a flat homogeneous wall shown in Figure 3. The direction of heat transfer (positive x-axis) is normal to the isothermal surface [5-9]. The cross section is not a function of x, i.e. $S = \text{const.}$, and the coefficient of thermal conductivity λ is constant (in a very real case, it still depends poorly on temperature and is affected by air humidity and pore dimensions, so these phenomena must be included in the calculation), so equation (4) reduces on:

$$\frac{d^2T}{dx^2} = 0 \rightarrow T(x) = a x + b. \quad (5)$$

This equation describes the temperature field of a single-layer wall. There are two integration constants: a and b , which are determined from the initial boundary conditions: $T(0) = T_1$ and $T(L) = T_2$: $a = \frac{T_2 - T_1}{L}$; $b = T_1$. Finally, the temperature field of this simple wall is described by the expression:

$$T(x) = T_1 + (T_2 - T_1) \frac{x}{L}. \quad (6)$$

Thus, the quasi-stationary temperature profile through a flat single-layer wall is linear, as in Figure 3.

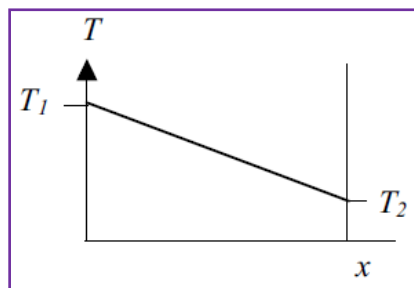

Figure 3. Temperature profile through the plane wall

For the heat flux in a unit of time, defined by expression (2), taking into account that $S = \text{const}$ and that it can be assumed that $\lambda = \text{const.}$, we obtain:

$$\dot{q} = - (T_2 - T_1) \frac{\lambda}{L} = \text{const}. \quad (7)$$

Therefore, normally through a flat homogeneous wall, the change in temperature is a linear function of the distance from the beginning of the wall, and the heat flux in a unit of time is constant.

2.4. HEAT CONDUCTION THROUGH A MULTILAYERED WALL

We will now consider heat transfer through a wall consisting of parallel vertical layers. Each individual layer represents a different and particular material with a certain thickness (Figure 4).

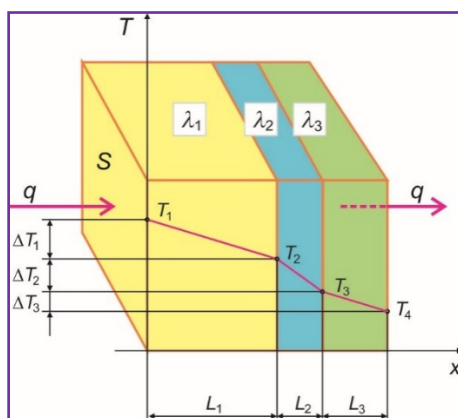

Figure 4. Heat conduction through multilayer wall

Taking into account equations (6) and (7), the amount of heat that passes through each layer can be determined individually [10-13]. As the heat flux of a single-layer wall is a constant quantity, it will be the same through each of the wall layers. After defining the boundary conditions, the following follows:

$$\begin{aligned} Q_1(T_2) &= Q_2(T_2); \\ Q_2(T_3) &= Q_3(T_3); \\ &\vdots \\ Q_{n-1}(T_n) &= Q_n(T_n); \end{aligned} \quad (8)$$

and replacing them in equation (7), after integrating expression (6) – a system of equations is obtained that describes the amount of heat in individual layers:

- for the 1st layer

$$Q_1 = \frac{\lambda_1}{L_1} (T_1 - T_2) S_1 t, \quad (9a)$$

- for the 2nd layer

$$Q_2 = \frac{\lambda_2}{L_2} (T_2 - T_3) S_2 t, \quad (9b)$$

- for the nth layer

$$Q_n = \frac{\lambda_n}{L_n} (T_{n-1} - T_n) S_n t. \quad (9c)$$

These relations represent the application of Fourier's law to multilayer walls. If heat passes through a system consisting of several layers of material arranged in parallel – next to each other, in the case of stationary conduction [6-9], the same amount of heat per unit time passes through each layer, ie:

$$\dot{Q} = \frac{\lambda_1}{L_1} S_1 \Delta T_1 = \frac{\lambda_2}{L_2} S_2 \Delta T_2 = \frac{\lambda_3}{L_3} S_3 \Delta T_3 = \dots \quad (10)$$

As all these surfaces are (approximately) equal, i.e. $S_1 = S_2 = S_3 = \dots \equiv S$, and if from (10) are expressed:

$$S \Delta T_1 = \dot{Q} \frac{L_1}{\lambda_1}; \quad S \Delta T_2 = \dot{Q} \frac{L_2}{\lambda_2}; \quad S \Delta T_3 = \dot{Q} \frac{L_3}{\lambda_3}; \quad \dots$$

and when we all these terms summarize, we get:

$$S (\Delta T_1 + \Delta T_2 + \Delta T_3 + \dots) = \dot{Q} \left(\frac{L_1}{\lambda_1} + \frac{L_2}{\lambda_2} + \frac{L_3}{\lambda_3} + \dots \right). \quad (11)$$

The sum of temperature differences through the layers is equal to the temperature difference between the two outer layers of the complex system, i.e. $\dot{Q} = -\lambda S \frac{dT}{dx}$. On the other hand, based on the definition of the heat transfer coefficient from (1), it follows:

$$\frac{L_1}{\lambda_1} + \frac{L_2}{\lambda_2} + \frac{L_3}{\lambda_3} + \dots = \frac{1}{K_1} + \frac{1}{K_2} + \frac{1}{K_3} + \dots \equiv \frac{1}{K_U}, \quad (12)$$

where K_U is the total (effective) heat transfer coefficient of the complex system, which is also expressed in $[W/(m^2 \text{ } ^\circ\text{C}) \equiv W/(m^2\text{K})]$. Based on expressions (10) to (12), the expression of heat

current - the amount of heat in a unit of time, a complex system - a multilayer wall, is given in the following form:

$$\dot{Q} = K_U S \Delta T. \quad (13)$$

This is one of the most important quantities that evaluates the energy efficiency of the wall, and heat transfer through the whole building (when considering the whole building as complex unity) [10-13]. We have calculated the heat transfer coefficients of individual layers based on standard data (given in following data tables). Thermal conductivity coefficients of observed (and used) materials are known, and we vary their required thicknesses, and the wall surface sizes, according to specification of the building design, while the largest temperature differences are set in relation to the geographical position and orientation of the object.

3. EXTERNAL WALL INSULATION

Today, a large number of insulating materials are used. Depending on the degree of insulation, an appropriate combination of materials can be chosen [1,4,8-15]. This section will present several possible combinations and consider their applicability in the light of energy efficiency. From the external walls are also required thermal stability, i.e. characteristic (or property) that the wall in the summer retains the relevant temperature stability on its inner surface. If a ventilated air layer is provided in the wall cladding on the outside, it is not necessary to check the thermal stability. This air layer also serves to remove water vapor from thermal insulation materials (Figure 5). The calculated values for such an assembly are given in Table 1 and graphically presented in Figure 6.

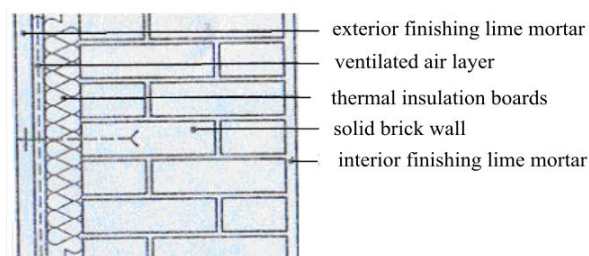

Figure 5. The cross section of the constructions for the external insulation for the air-layer

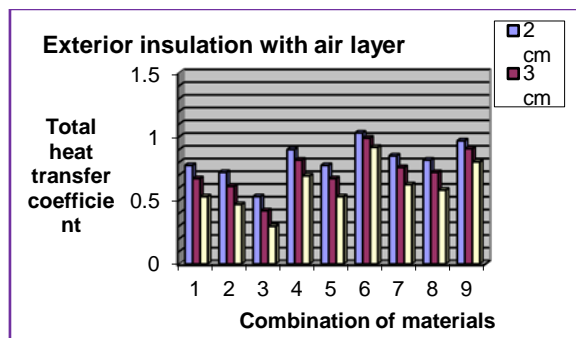

Figure 6. The total coefficient K_U in dependence of the layer combination (Table 1) and thickness of thermo-insulating material (given in legend)

Table 1. The total transfer coefficient for various compounds of the material; calculated for the combination of two lime mortar with an air interlayer, solid brick facade and thermo-insulation material (from [15])

The # of combination	Material		The heat conductance	The heat transfer coefficient $K = \lambda/L$ [W/(m ² °C)]				The heat transfer coefficient $K = \lambda/L$ [W/(m ² °C)]		
				Insulation thickness L			Insulation thickness L	$L = 0.02$ m	$L = 0.03$ m	$L = 0.06$ m
				0.02 m	0.03 m	0.05 m				
	Lime mortar 2 cm		0.85				42.50			
	Layer of air 1 cm		0.02				2.30			
1.	Insulation thickness L plate of:	Styrofoam-expanded polystyrene	0.04	2.5	1.67	1.0		0.77	0.67	0.53
2.		Cork	0.03	2.0	1.33	0.8		0.72	0.61	0.47
3.		Polyurethane	0.02	1.0	0.67	0.4		0.53	0.42	0.29
4.		Stitched straw	0.09	4.5	3.00	1.8		0.90	0.82	0.69
5.		Stitched reed	0.05	2.5	1.67	1.0		0.77	0.67	0.53
6.		Durisol	0.25	12.5	8.33	5.0		1.30	0.99	0.92
7.		Expanded perlite	0.07	3.5	2.33	1.4		0.85	0.76	0.63
8.		Honeycomb plastic	0.06	3.0	2.00	1.2		0.82	0.72	0.58
9.		Mineral wool	0.14	7.0	4.67	2.8		0.97	0.90	0.80
	Solid brick 25 cm		0.61				2.44			

As can be easily seen from Table 1 and the graph in Figure 6, the total wall thickness does not exceed 35 cm. Judging by these values, the air layer contributes greatly to the thermal insulation of a given assembly. It is noticed that the combination 3 gives the lowest value of the total coefficient of heat transfer, therefore it provides the best thermal insulation. Combinations 1 and 2, as well as 5 and 8 also give very good results. Lately, hollow blocks are used more, partly because masonry is faster, buildings are lighter, and because of the need to save thermal energy (regulations for thermal protection are stricter, so the thickness of external walls built of solid brick would increase significantly). Table 2 will give the same combination of materials as Table 1, only with hollow brick. A graphical representation of these results is given in Figure 7.

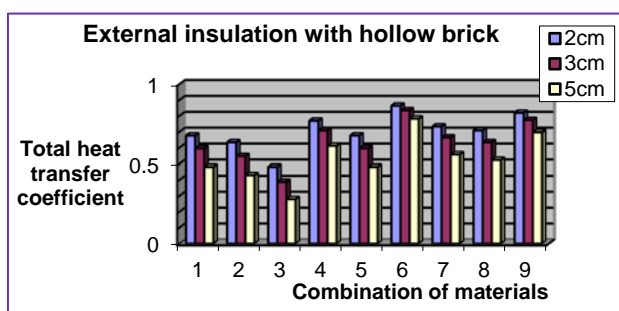

Figure 7. The total coefficient K_u in dependence of the layer combination (Table 2) and thickness of thermo-insulating material (given in legend)

Table 2. The total transfer coefficient for various compounds of the material; calculated for the combination of two lime mortar with an air interlayer, hollow brick and thermo-insulation material (from [15])

The # of combina	Material	The heat condu	The heat transfer coefficient $K = \lambda/L$ [W/(m ² °C)]	The heat transfer coefficient
------------------	----------	----------------	---	-------------------------------

			Insulation thickness L			Insulation thickness L	$K = \lambda/L$ [W/(m ² °C)]			
			0.02 m	0.03 m	0.05 m		$L = 0.02$ m	$L = 0.03$ m	$L = 0.05$ m	
	Lime mortar 2 cm		0.85						42.5	
	Layer of air 1 cm		0.02						2.3	
1.	Insulation thickness L plate of:	Styrofoam-expanded polystyrene	0.04	2.5	1.67	1.0		0.68	0.60	0.48
2.		Cork	0.03	2.0	1.33	0.8		0.63	0.55	0.43
3.		Polyurethane	0.02	1.0	0.67	0.4		0.48	0.39	0.28
4.		Stitched straw	0.09	4.5	3.00	1.8		0.77	0.71	0.61
5.		Stitched reed	0.05	2.5	1.67	1.0		0.68	0.60	0.48
6.		Durisol	0.25	12.5	8.33	5.0		0.86	0.84	0.78
7.		Expanded perlite	0.07	3.5	2.33	1.4		0.73	0.66	0.56
8.		Honeycomb plastic	0.06	3.0	2.00	1.2		0.71	0.63	0.52
9.		Mineral wool	0.14	7.0	4.67	2.8		0.82	0.77	0.70
	Hollow brick 25 cm		0.42						1.7	

It can be seen from Table 2 and Figure 7 that the maximum wall thickness is 35 cm, but very good insulation was obtained even with a total wall thickness of 32 cm. It can be noticed that the best insulation is provided by the combination with a 5 cm thick polyurethane board, given under no.5. 2 cm thick Durisol plate provides the weakest protection. It can be noticed that approximately the same value of the total coefficient heat transfer is given by the combination of 5 cm thick expanded polystyrene, cork and reed. The combination with 2 cm thick polyurethane provides almost the same protection. The 5 cm thick straw or mineral wool joint provides similar protection as the combination of reed, expanded perlite or 3 cm thick honeycomb plastic. Comparing the results from Tables 1 and 2, as well as the graphs from Figures 6 and 7, it is noticeable that better protection is obtained with each combination when hollow is used instead of solid brick.

4. CONCLUSIONS

In this paper, we have calculated heat conduction coefficients through different walls. The advantages and necessity of installing thermal insulation are stated and examples of several combinations for two ways of passive insulation are given and analyzed. Only thermal insulation of the wall was considered. Numerous thermal insulation materials are presented and the value of the total heat transfer coefficient for a large number of combinations is given. It was stated that it is more adequate to install the outer insulation than the inner one, because the insulating shell does not break, which avoids the formation of "thermal bridges" and the protection becomes more complete. The results obtained when calculating the total heat transfer coefficient speak for themselves. It is clear that leaving an air layer not only regulates the removal of water vapor from thermal insulation materials, but also provides better protection. It has been shown that the use of hollow bricks in combination with an air layer provides the best insulation. There are several other reasons why it is more convenient to use hollow bricks instead of solid bricks. The disadvantage of this construction in relation to the external insulation is that the walls are very thick, for example 40 or 45 cm, although this thickness can be reduced to 32 cm and meets the minimum of energy requirements.

The next important result of the simulations is yet to come. The test simulation proved to be accurate because it confirmed the well-known results and facts about the importance of installing insulation layers, the use of air layers inside walls and finally the use of composite structures. The next phase of research will include the use of very thin insulation layers and simulation of heat flow through these structures, when made in the form of composite layers or superlattices. In that sense, previous research and developed simulations have a test or control function.

ACKNOWLEDGEMENT

The research presented in this paper was financially supported by the Ministry of Scientific and Technological Development, Higher Education and Information Society of the Republic of Srpska (Projects No. 19.032 / 961-36 / 19 and 19.032 / 961-42 / 19).

LITERATURE

- [1] M. Muravljov, *Construction materials*, ISBN: 978-86-395-0512-7, Građevinska knjiga, Belgrade, 2007, pp. 33-40, 135-137, 242-245. – In Serbian
- [2] J.P. Šetrajić and S.M. Vučenović, “Energy resources – potentials and perspectives”, in *Proc. Retrospective of Scientific Thought and Vision of AGF Development in Banja Luka*, Vol. 1, 2006, pp. 52-58.
- [3] J.P. Šetrajić and D.Lj. Mirjanić, *Biophysical foundations of technology and medicine*, ISBN: 987-99938-21-36-6, Academy of Sciences and Arts of the Republic of Srpska, Banja Luka, 2012, pp. 127-128, 132-133. – In Serbian
- [4] B.M. Živanović, *Materials in construction*, Faculty of Technical Sciences, Novi Sad, 1981, pp. 2-65. – In Serbian
- [5] W.S. Janna, *Engineering heat transfer*, 2nd Ed., ISBN: 0-8493-2126-3, CRC Press, New York, 2000, pp. 1-24, 35-98.
- [6] “Conductive Heat Transfer”, Internet: https://www.engineeringtoolbox.com/conductive-heat-transfer-d_428.html
- [7] “Steady Heat Conduction“, Internet: <http://cecs.wright.edu/~stthomas/hchapter03.pdf>
- [8] “Heat Conduction through Walls – Thermal Engineering”, Internet: <https://www.engineeringenotes.com/thermal-engineering/heat-conduction/heat-conduction-through-walls-thermal-engineering/30104>
- [9] “Conduction Heat Transfer”, Internet: <https://www.sciencedirect.com/topics/engineering/conduction-heat-transfer>
- [10] Wei Chen, *A Study of Heat Transfer in a Composite Wall Collector System with Porous Absorber*, Proceedings of the Sixth International Conference for Enhanced Building Operations, (Shenzhen, China, November 6 - 9, 2006), Vol.VIII-3-1.
- [11] K. Fodor, *Conducting heat through the wall*, Diploma work, Faculty of Sciences, Novi Sad, 2011, pp. 5-21. – In Serbian
- [12] N. Nenadov, *Energy efficiency project for a residential building in Novi Karlovci*, Diploma work, Faculty of Technical Sciences, Novi Sad, 2014, pp. 5-19. – In Serbian
- [13] N. Šetrajić, S.K. Jaćimovski, J.P. Šetrajić: Heat exchange through composite walls, *Zaštita Materijala* 58/2, 163-170 (2017).
- [14] “Portal of the construction industry of Serbia”, Internet: www.gradjevinarstvo.rs/
- [15] “Rulebook on energy efficiency of buildings”, *Službeni glasnik RS*, No. 61, 2011. – In Serbian



Slobodan Bulatović, University of Belgrade, bulatovic-s@hotmail.com

THE INFLUENCE OF A REGULATED CITY COAST ON THE QUALITY OF LIFE IN THE CITY OF BRČKO

Abstract

Urban development has always been related to the proximity of watercourses and the possibility of their use. Water in urban areas is essential for various infrastructure systems. Water areas in cities are also crucial for the population because they enable multiple activities. On the city shores along rivers or lakes, different spatial concepts are being developed that have a specific impact on the quality of life of the city's inhabitants. In this paper, the influence of such shores on the quality of city life will be examined in the example of the arranged city coast in the city of Brčko. Therefore, a structural analysis of the coast will be done, followed by an analysis of the quality of that area. The research results seek to raise awareness of the importance of these areas in cities.

Keywords: city coast, structure, quality criteria, impact

УТИЦАЈ УРЕЂЕНОГ ГРАДСКОГ ПРИОБАЉА НА КВАЛИТЕТ ЖИВОТА У ГРАДУ БРЧКО

Сажетак

Урбани развој је одувек био везан за близину водотока и могућност његовог коришћења. Вода у урбаним срединама је неопходна за различите инфраструктурне системе. Водене површине у градовима су значајне и за становништво јер омогућавају вишеструке активности. На градским обалама уз ријеке или језера развијају се различити просторни концепти који специфично утичу на квалитет живота становника града. У овом раду ће се на примјеру уређене градске обале у граду Брчко испитати утицај оваквих обала на квалитет градског живота. Због тога ће бити урађена структурна анализа обале, као и анализа квалитета тог подручја. Резултатима се настоји подићи свијест о значају ових подручја у градовима.

Кључне ријечи: градско приобаље, структура, критеријуми квалитета, утицај

1. INTRODUCTION

Cities and their development have always been related to waters and shores. The importance of watercourses for the inhabitants of a particular area has been crucial throughout history because its proximity to the place of residence meant the possibility of water supply, irrigation of the agricultural regions, and many other benefits [1]. Such importance of water is identical in modern cities, with, of course, different ways of treatment. In urban agglomerations, water surfaces are unavoidable elements of city infrastructure. These areas are an integral part of the supply of residential buildings with sanitary water and drinking water and maintaining urban cleanliness [2]. Water in cities is also used as a recipient of wastewater, i.e. wastewater from households and industry is discharged into it. Unfortunately, these wastewaters are not adequately treated and thus pollute watercourses and affect their quality and capacity [3]. Therefore, it is clear that water surfaces directly impact the functioning of cities and hence the quality of life in them. Another vital role of watercourses in cities is the impact on the quality of the environment. Water surfaces in urban areas are regulators of harmful effects, but they also can cause specific adverse effects. Watercourses affect the air quality in urban areas because they enable air circulation over their surfaces. In the warmer months, they regulate thermal differences in their environment [4]. The advantage of water in cities is that they encourage the development of green areas in their immediate environment, but course, if that space is not concreted [5]. All this, of course, indicates that water affects the environment in cities and thus improves citizens' quality of life. On the other hand, polluted or blocked watercourses can cause damage to urban areas due to floods [6]. The rapid urbanization of space, which increases built and paved sites, dramatically affects the increasing floods in urban settlements, especially those located along rivers [7].

However, watercourses play another crucial role in urban areas. Rivers or lakes in cities can be considered parts of the landscape that give a unique quality to urban environments. Namely, in addition to water surfaces in cities, it is almost always possible to find coastal areas with specific economic, sociological, cultural, ecological, or other values. Due to the proximity of water, flat terrain, width or different potentials, these spaces are often used in cities to develop quality housing. However, on the other hand, many cities worldwide treat these spaces differently, i.e. as open public spaces. Coastal areas are, without a doubt, places that have historically attracted the population of the urban regions in various ways. These areas, as mentioned, were primarily forested, grassy areas that allowed the people to connect with nature [8]. Also, the coastal parts of cities have attracted, and still attract, anglers and all other lovers of activities related to water areas [9]. Due to the mentioned numerous other qualities, these spaces are still one of the essential open public spaces in cities. In urban areas, spaces for sports activities are being developed in coastal areas today, making them more attractive to different population categories. Also, in recent years, catering facilities have been a natural magnet for people and these spaces. If we consider the fact that open public spaces are places that should allow residents of a particular city to spend quality free time [10], it can be concluded that well-equipped coasts are. Urban spaces, including coastal areas as open public spaces, attract more attention from researchers and various actors in space [11]. This can be especially noticed if we analyze the New Urban Agenda of UN-Habitat, in which inclusive, accessible and green public spaces are characterized as very important in the formation and regeneration of healthy, smart cities [12].

From the above, it can be concluded that open public spaces are significant parts of urban areas and that urban areas and water areas are substantial for urban spaces. However, this paper raises the question of whether this is the case, i.e. how vital the city coast is in quality of life. More precisely, the specific question is: What is the impact of an organized urban space on the quality of life in the city? The term "arranged coastline" can mean a built space intended for housing and work, but it can also be an open public space adapted to citizens' needs. These needs certainly include performing recreational activities or physical and mental rest [13]. Precisely such a coast will be analyzed in this paper. In other words, this paper aims to investigate the impact of the urban coastline, which is characterized as a public space, on the quality of life based on its morphological characteristics. According to Cliff Mougthin [14], the morphological component of a specific space is very important because urban forms and space configurations play a crucial role in terms of the quality of life in the city.

The real impact of public space along the river on the quality of life in the city will be researched in the example of the city of Brčko, i.e. the coast in this city. First of all, a structural analysis of the regulated coastal area will be done and shown on the map. After that, the elements located along the river will be evaluated according to specific criteria to determine their importance in attracting residents. The quality of the city's coastline certainly directly impacts the quality of life. Finally,

based on the results obtained in this research, relevant conclusions will be drawn on the effect of the regulated urban coastline, which is characterized as an open public space, on the quality of life in the city. These conclusions will undoubtedly raise awareness of the importance of water bodies and their immediate environment for the city. Also, the research aims to remind all actors in spatial planning of the importance of natural open public spaces in urban areas.

2. BACKGROUND RESEARCH

Urban coastlines, as mentioned in the introductory part of the paper, are of great importance for metropolitan areas and the quality of life in those areas. That is why these spaces are exciting for all actors in the processes of urban development. This primarily refers to city architects and urban planners, then investors who want to use these spaces for personal profit, including citizens. During the development of these spaces, the decision of local authorities is the most important because it depends on whether the areas along the water surface will become part of the built structure intended for housing or enjoyment only by specific layers of society or will be treated as quality public spaces that all residents can use. Examples of the use of the coast as new development centres in urban areas can be found around the world. Such a case can be observed in Hamburg, Germany, where a completely new city called Hafen City has sprung up on the coast. The area where the new city was developed was once used for the needs of the port of Hamburg, and today it is one of the most attractive spaces in this City in northern Germany [15]. It is important to emphasize that the development of this new settlement in Hamburg has affected the overall quality of life in the city by increasing new open spaces by the water and increasing the number of jobs.

Another example is the City of Belgrade, Serbia, where the Belgrade Waterfront project is underway, seeking to create an entirely new urban identity for the city coast [16]. This project also encourages the settlement of people but also forms new open public spaces. However, it is vital to conclude that such restoration of neglected urban coasts can be considered projects for restoring brownfield sites [17].

In addition to treating coastal areas as neglected sites needing restoration, there are many cities where these sites are open public spaces. Many cities worldwide located along the coastal waters use promenades that attract visitors and are, therefore, critical local public spaces [18]. Such promenades in themselves indeed represent public spaces that, due to the environment in which they are located, which certainly includes watercourses as a fundamental element, affect the presence of a more significant number of people and thus the interactions between them. In addition to the riverfront promenade, Mark Francis defines waterfronts as open public spaces in his research on urban public areas [19]. He explains that these are spaces that cities along the watercourses are trying to develop as public and therefore form various parks or playgrounds with them. Although it is clear that urban shores with housing infrastructure are rarely designed to support biodiversity and other ecosystem features [20], it is evident that spaces treated as open public support this to a large extent. In recent years, the general awareness among the city's residents is that the city's shores are ideal places for rest and recreation. Many cities strive for this kind of coastal treatment, and one example is undoubtedly the coast in the City of Kuching, Malaysia, which has been going through a sort of transition for many years from the historic coast, through neglected space to new mixed development with the coastal park [21]. Also, throughout North America and Europe in recent decades, the flourishing of parks and other facilities on the coast has been recorded, so in addition to the development of mixed-use space on the coast, an increasing number of different activities such as exhibitions on the coast and some festivals and other events in such public areas [22]. All this certainly shows that using city shores as public spaces is a specific way to group people and raise the quality of their lives.

In this paper, however, this statement is analyzed, i.e. it is difficult to define the precise impact of the regulated urban coast, which is treated as an open public space, on the quality of life of urban residents. Coastal areas used as open public spaces can be considered golden urban zones because they provide access to freshwater air and, most importantly, allow escaping from city crowds and pressure [23]. Furthermore, parks and arranged public spaces on the city shores can be defined as extremely valuable and unique because they represent a combination of watercourses and green areas that meet urban residents' physical and social needs [24]. Finally, it is essential to note that residents in cities worldwide believe that landscaped coastal areas, treated as open public spaces, impact the quality of life, as shown by various studies in Boston, USA [25].

Without a doubt, it can be said that there is a strong link between urban space and the quality of life in the city, which can be seen in the example of the city of Barcelona. There is a policy of reducing carbon emissions in this city. This is achieved by providing residents with more accessible and

efficient access to quality open public spaces. However, an aggravating circumstance for these residents is a large number of tourists every day who make it difficult to access these areas, resulting in dissatisfaction among the population. Of course, all this reflects on the quality of life in Barcelona [26]. Also, when it comes to quality open public spaces that attract citizens and other visitors, it is necessary to list the essential features they must possess. First of all, these spaces must be comfortable, enjoyable, and inclusive [27]. Indeed, these spaces must provide a sense of security, physical and environmental comfort, and feelings of control and enjoyment [28].

The city of Brčko is undoubtedly one of the cities that was developed on the river banks, so even today, the coast is a crucial segment of the urban structure. In the example of the city coast, i.e. one part of the coast called Ficibajer, in this paper, we will investigate the contribution of a landscaped coast to a better quality of life in the city. The mentioned locality is a city picnic area used daily and has the infrastructure typical of open public space. Structural analysis of the Ficibajer picnic area will be done with a clear definition of all segments used by the population to determine the real impact of the coast on the quality of life. Then these elements will be assessed using quality criteria. Finally, the analysis will be performed with the help of a map to make it easier to understand the space.

3. METHODOLOGY

Analyzing the structure or form of a particular phenomenon or entity is called morphological analysis [29]. With the help of morphological analysis of a city or a specific space, it is possible to obtain relevant data on all the elements that create that space. For this particular case, in the example of the analysis of the urban coast, it is possible to obtain data on the distribution, connection and representation of various elements and spatial functions through morphological or structural analysis. In her research on park elements as bearers of recreational potential, Petra Pereković [30] states that structure is defined as a set of pieces of which that space is composed in open spaces. With such analyses, it is undoubtedly possible to separate individual elements from the whole and then classify them into specific categories according to the idea of the research [31]. This is precisely the analysis of space that is the core of this research. By isolating the spatial elements that create a particular open public space, the city coast in this research, it is possible to examine its direct impact on the quality of the coast and thus the effect of the overall observed space on the quality of life in the city. Of course, the connection between spatial elements, the quality of open public space, and quality of life can be made because each spatial piece affects visitors' feelings or creates a specific feature of open public space. For example, a bench allows them to develop a sense of comfort, security or connection with space and, at the same time, influences the creation of a spatial landscape.

When it comes to the criteria for the quality of open public spaces, it can be said without a doubt that they are numerous and represent an entire area ideal for research. However, in this paper, certain specific criteria will be used to show the influential spheres of any particular space on the life of urban residents. It is important to note that many researchers have dealt with quality criteria, and many of them are still dealing with this topic. One of the researchers is Jan Gehl, who classified the criteria into three categories and defined them on specific issues [32]. For the analysis of the city coast in Brčko, a criterion will be used to analyze comfort, which Gehl states is satisfied if the space allows users to sit, talk, watch, enjoy or play. Another crucial criterion for the analysis of the city coast is the representation of green areas and the quality of the environment. For an open public space located along a river or other body of water in the city, it is crucial that it has green areas or is not fully concreted or built, and this certainly affects the quality of the environment that the population has within the built urban space [33]. For the area to have a broader impact on society, all demographic categories must visit it. Therefore, it is imperative to analyze whether the space in the structure has elements that attract all types of people, regardless of whether they are the oldest or youngest citizens [34]. With the help of these three criteria, it is possible to clearly define whether the regulated city coast impacts the quality of life in the city. Of course, a much more extensive range of quality criteria can be used. Still, with the three described, it is possible to explore the spatial elements isolated through structural analysis and determine their impact on the quality of urban life.

As mentioned, the area of the city coast in Brčko will be shown on the map with all the elements of the spatial structure. Mapping spatial elements are beneficial because it helps all stakeholders discuss a particular space. After all, it helps form an image of a specific area [35]. Therefore, in this research, the map will certainly be significant to justify the results obtained by structural and qualitative analysis. Furthermore, by mapping the space, the results of a morphological analysis can be

presented, and the study of the quality of open public space because they define the arrangement of spatial elements. Therefore, a map of a specific area, together with morphological analysis and analysis of the quality of open public space, can undoubtedly help obtain clear answers to whether and in what way the city coast affects the quality of life in the city.

4. CASE STUDY - CITY OF BRČKO

The city of Brčko is one of the cities in Bosnia and Herzegovina, located along the Sava river in the country's northeastern part. This city represents a specific local community because it primarily functions independently of the entities located in BiH and the state itself [36]. The position of the city, as well as the entire municipality, is designed so that it stretches from the mountain Majejica in the south to the river Sava in the north [37]. In that way, hilly and lowland areas participate in the relief. From the entire geomorphological structure of the city, one site along the Sava River is interesting for this work, which represents an arranged city coast. This locality is called Ficibajer, and in the Urban Plan of the city of Brčko, it is characterized as the most crucial city park [38]. The plan states that the advantage of this location is that clean air comes from the river, which has a specific impact on the microclimate of the coast. The total area of this space is just over 40ha. However, only the part located next to the river, which was developed as a picnic area, will be analyzed in this research.



Figure 1. *The position of the arranged urban coast in the structure of the City of Brčko*

As shown in Figure 1., the Ficibajer public space is located within a narrower urban area. It is a location accessible to all residents of the city of Brčko. The name of this location dates back to the period of Austro-Hungarian rule, which can be concluded based on the words from which the name was formed. "Bayer" in German means hill, coast, uphill, while the etymology of the word "Fici" is not known [39].

5. RESULTS

Urban coasts in recent decades have influenced the movement of urban development by opening new aesthetic, economic, social and environmental opportunities to cities [40]. The regulated coastline in Brčko shows its importance precisely through the stated potential. The social possibilities of such spaces attract the population and enable their connection with the help of various structural elements [41].

5.1. STRUCTURAL ANALYSIS OF THE CITY COAST

As stated, this part of the paper analyzes the morphology of the city coast in Brčko. Based on this analysis, it is possible to determine the purpose of the space elements. Also, with the help of this analysis, it is possible to find out further what impact these spatial elements have in attracting the population. Finally, the structural analysis will be done with the help of a table that will list the spatial features, their total number, and information on whether these elements are currently in operation.



Figure 2. Morphological map of the city coast of Ficibajer

Figure 2. presents the morphological structure of the city coast in Brčko. As can be seen on the map, the morphological structure is dominated by space for sports and recreation, while also a large part of the coast is predestined for day trips with barbecue and entertainment. Paths have a crucial role in the structure of this coast because they connect all morphological units.

Table 1. Structural analysis of the urban coastline

<i>Land use</i>	<i>Land description</i>
<i>Sports and recreational space</i>	<i>Area for sports and recreational activities with lots of green spaces and forests.</i>
<i>Barbecue and entertainment space</i>	<i>Space intended for barbecue and socializing.</i>
<i>Space for rest and enjoyment</i>	<i>Part of the city coast is destined for enjoying the landscape and mental and physical rest.</i>
<i>Coastal belt</i>	<i>Part of the open public space along the river with defined access to water.</i>
<i>Paths</i>	<i>Hiking trails that connect different spatial units of the city coast.</i>

Table 1. defines the purposes of spatial units that participate in the structure of the city coast in Brčko. Different spatial units within this open public space provide all visitors with many different ways to use their free time. Pedestrian paths that pass along all the listed spatial units have a significant role. Also of great importance are the green areas present in all these spatial units, the presence of the river, and the access to the river. Certainly, spaces for socializing and entertainment and a space for rest are essential. It is clear that the whole area has excellent potential and the quality to provide entertainment to citizens every day and thus improve their life in the city.



Figure 3. *The position of the arranged urban coast in the structure of the City of Brčko*



Figure 4. *The position of the arranged urban coast in the structure of the City of Brčko*

Figures 3. and 4. show their actual appearance and purpose and the presence of almost all spatial elements on the city's coastline.



Figure 5. Map of the city coast of Ficibajer

As can be seen on the map (Figure 3.), the city coast of Ficibajer possesses a large number of different spatial elements. Therefore, based on the map (Figure 3.), all the features that make up the structure of this open public space will be recorded.

Table 2. Spatial elements on the city coast

<i>Spatial elements</i>	<i>The total number of the specified element</i>	<i>In the function of (+/-)</i>
<i>Sports fields</i>	4	+
<i>Concrete table tennis</i>	2	-
<i>Great chessboard</i>	1	+
<i>Paths</i>	2	+
<i>Shed tables with benches</i>	13	+
<i>Benches</i>	16	+
<i>Concrete grills with tables</i>	10	+
<i>Catering facilities</i>	3	+
<i>Showers</i>	3	-
<i>Water plateau</i>	1	+

<i>Forests</i>	<i>1</i>	<i>+</i>
<i>Outdoor gym</i>	<i>1</i>	<i>+</i>
<i>Beaches</i>	<i>0</i>	<i>-</i>
<i>Parking</i>	<i>1</i>	<i>+</i>
<i>Other facilities</i>	<i>3</i>	<i>+</i>

As can be seen in Table 1, there are a large number of different spatial elements in the Ficibayer coastal area. Almost all the listed features have the fundamental purpose of attracting the population to the location of the observed coast. Also, these elements are characteristic of open public spaces, such as the city coast of Ficibayer. This coast has all the necessary elements to attract the population and their mental and physical rest and perform recreational activities in morphological structure. Also, these elements certainly encourage mutual interaction between different demographic categories of the people. However, it is undoubtedly important to note that some spatial elements in this locality are not in function. Their re-training would undoubtedly raise the quality and attendance of this city coast. Also, this space has a lot of potential for further development and progress. This primarily refers to the possibility of introducing content such as water sports or the use of free space for exhibitions and other activities.

5.2. QUALITY ANALYSIS OF THE CITY COAST

In this part of the paper, the quality of the city coast of Ficibajer will be examined. This study should help define the answers to the impact of the city's coastline on the quality of life in the city. To accurately determine the quality of this public space and its effect on the quality of life in the city, a descriptive criterion will be analyzed with the help of the already presented spatial elements.

Table 3. The quality of the city coast as an open public space

<i>Quality criteria</i>	<i>Description</i>
<i>Comfort</i>	<i>The visible presence of many different spatial elements enables the comfort of all visitors to this space.</i>
<i>Green spaces; environment</i>	<i>As shown in the morphological analysis, this space has many green areas and, with their help, creates an exciting, attractive, and relaxing environment.</i>
<i>Demographic categories of visitors</i>	<i>The city coast in Brčko has many different spatial elements that meet the needs of all users, regardless of which demographic category they belong to.</i>

Table 3. defines the answers to the quality criteria based on the analysis of the morphological structure and existing spatial elements within the scope of the regulated urban coast in Brčko.

Based on the spatial elements, it can be concluded that there is spatial heterogeneity, i.e., fragments from different categories are represented. In this regard, it can be supposed that comfort as a quality criterion is satisfied because all visitors to this area are allowed to spend their free time and rest excitingly. Furthermore, the space for recreational activities is undoubtedly provided, which improves the quality of this location and the existence of catering facilities which, together with water surfaces and other segments of the structure of this area, are a magnet for most residents of Brčko.

When it comes to the criteria related to the representation of green areas and the quality of the environment, it is clear that he is also satisfied. As already mentioned in the paper, water surfaces with open public spaces are essential in creating a microclimate with lower temperatures than within

the built urban fabric and cleaner and better quality air. Also, as can be seen on the map (Figure 5.), in the area of the studied urban coast, green spaces make up much more than half of the spatial coverage, which certainly means that they are represented in a large percentage. Of course, there is a lot of potential for the introduction of other elements of landscaping, such as new flower beds or a city garden.

The city coast in Brčko, treated as an open public space, is indeed a location that can complete the free time of all residents of Brčko, and this can be seen based on the presence of various facilities such as sports fields, chess boards, barbecues, etc. Undoubtedly, it can be stated that multiple elements on this coast of the city can attract entire families on full-day trips or at shorter intervals. The advantage of this coast is that it creates a charming and attractive urban landscape with all the built elements and natural resources.

6. DISCUSSION AND CONCLUSIONS

Examining the impact of a specific open public space on the quality of life in an urban environment is exciting research. Seeking answers to this question can be helpful to the urban profession but also to science in defining the interrelationships between a particular space and its users. Therefore, three interrelated types of analysis were applied in this paper. First, with the help of the map of the arranged city coast in the city of Brčko, the morphological structure of this area was defined. Also, all the elements that make up this space are determined based on the map. All this was done to get a clear picture of the arranged city coast in Brčko, which represents this city's vital open public space. As mentioned, such spaces are part of the everyday life of citizens, and therefore they must be adequately equipped and accessible [42]. After the structural analysis of space, this paper uses specific criteria that can answer the connection between the quality of open public space and its impact on the lives of residents in the city. In that way, the answer was given to how much the structure of the arranged city coast is adjusted to all citizens and whether it affects the improvement of the quality of their life in the city.

City coasts are vital segments of the urban structure. Regardless of whether these spaces are intended for housing or are used as open public spaces, their spatial potential and the impact on the quality of life in the city are of great importance. These spaces in cities are a fascinating field of research because, in recent decades, these spaces have become attractive to various private investors. On the other hand, their importance for society and the city, in general, is far-reaching [43]. City coasts with a specific infrastructure are undoubtedly areas that are interesting to all city residents and, as such, have a crucial role in their lives.

As can be seen in this research, landscaped urban coastlines treated as open public spaces are elements of the urban structure that directly impact the quality of life of the city's residents. Let's go back to the beginning and consider that open public spaces are those parts of cities that allow informal socializing and rapprochement of different demographic categories of the population while providing the possibility of physical or mental rest and recreation. It is clear that Brčko certainly is. With the help of various spatial elements that participate in the morphology of the city coast in Brčko, this space can attract almost all city residents and provide them with a wide range of activities. All this certainly speaks enough in favour of the fact that these spaces certainly impact the quality of life in the city.

It is essential to point out that many coasts worldwide are not adequately developed and that their full potential is not being used. With intelligent planning policies, these spaces can become the central places of cities in terms of their sociological, economic, and social life. However, suppose these spaces are left to the will of various investors without the control of the local government or responsible planners. In that case, it can cause adverse effects on that location and the environment of the entire city. Therefore, to use such spaces in cities more actively and thus raise the quality of life in the city, it is proposed:

- Location of adequate locations along watercourses in cities that have spatial and social potential to become new open public spaces;
- Development of a plan for a new open public space along the river in which citizens, i.e. future users of that space, would participate throughout the entire process to express their wishes and requests to visit that space in the future;
- The existing open public spaces along the watercourses in the cities must be supplemented with different contents and green areas, if possible, to increase the quality of life in the city.

LITERATURE

- [1] Z. Živaković-Kerže, "Voda – osnova života Osijeka," *Anali Zavoda za znanstveni i umjetnički rad u Osijeku*, vol. No. 24, pp. 51 - 63, 2008.
- [2] I. Ipšić and I. Lazarević, "Water in the urban space of Dubrovnik," *Historical contributions = Historische Beiträge*, vol. 38, pp. 181 - 198, 2019.
- [3] S. Tedeschi, "Društvena opravdanost izgradnje uređaja za pročišćavanje otpadnih voda Zagreba," *Građevinar*, vol. 53, pp. 205 - 210, 2001.
- [4] G. Rosada, "Abitare ad Altinum. Topografia territoriale e urbana di una terra anfibia," *Histria antiqua*, vol. 20, pp. 11 - 32, 2011.
- [5] I. Anguelovski, J. Connolly and L. A. Brand, "From landscapes of utopia to the margins of the green urban life," *City*, vol. 22, pp. 417 - 436, 2018.
- [6] B. Restemeyer, J. Woltjer and M. van den Brink, "A strategy-based framework for assessing the flood resilience of cities – A Hamburg case study," *Planning Theory & Practice*, vol. 16, pp. 45 - 62, 2015.
- [7] V. Petrić-Stepanović, "Zaštita Slavenskog Broda od poplava bujičnih potoka," *Građevinar*, vol. 60, pp. 695 - 703, 2008.
- [8] A. Stupar, M. Milaković and A. Graovac, "Reaktivacija prirodnih potencijala Beograda - biofilija i biomimikrija kao nove komparativne prednosti," *Arhitektura i urbanizam*, vol. 37, pp. 35 - 42, 2013.
- [9] R. Boelens, J. Forigua-Sandoval, B. Duarte-Abadia and J. C. Gutierrez-Camargo, "River lives, River movements. Fisher communities mobilizing local and official rules in defense of the Magdalena River," *The Journal of Legal Pluralism and Unofficial Law*, vol. 53, pp. 458 - 476, 2021.
- [10] A. D. Nasution and W. Zahrah, "(2011). Public open space privatization and quality of life, Case study Merdeka square Medan. Bandung, Indonesia: Asean Conference of Environment – Behaviour Studies 15 – 17 June 2011.," in *Asean Conference of Environment – Behaviour Studies*, Bandung, Indonesia, 2011.
- [11] P. Hall, *Global city-regions in the twenty-first century*, Oxford: University Press, 2002.
- [12] M. W. Mehaffy, T. Haas and P. Elmlund, "Public space in the New Urban Agenda: Research into implementation," *Urban Planning*, vol. 4, no. 2, pp. 134 - 137, 2019.
- [13] A. Đukić, T. Vlastos and V. Joklova, "Liveable open public space – From Flaneur to Cyborg," in *CyberParks – The Interface Between People, Places and Technology*, Cham, Springer, 2019, pp. 38 - 49.
- [14] C. Moughtin, *Urban Design: Street and Square*, London: Routledge, 2003.
- [15] T. Krüger, "HafenCity Hamburg – ein Modell für moderne Stadtentwicklung?," *RaumPlanung*, vol. 146, pp. 193 - 198, 2009.
- [16] M. Petrović-Balubdžić, "Creating the Belgrade waterfront identity through a prism of architecture and urban planning competitions," *Spatium*, no. 37, pp. 74 - 81, 2017.
- [17] M. Grubbauer and N. Čamprag, "Urban megaprojects, nation-state politics and regulatory capitalism in Central and Eastern Europe: The Belgrade Waterfront project," *Urban studies*, vol. 56, no. 4, pp. 649 - 671, 2019.
- [18] M. Tanko, "Urban Waterfront Promenades," *Urban Policy and Research*, vol. 36, no. 3, pp. 388 - 389, 2018.
- [19] M. Francis, "Urban Open Spaces," in *Advances in Environment, Behaviour and Design*, New York, Springer, 1987, pp. 71 - 106.
- [20] K. Dyson and K. Yocom, "Ecological design for urban waterfronts," *Urban Ecosystems*, vol. 18, pp. 189 - 208, 2015.
- [21] S. M. Ali and A. H. Nawawi, "The social impact of urban waterfront landscapes: Malaysian perspectives," in *Proceedings REAL CORP 2009 Tagungsband*, Schwechat, Austria, 2009.
- [22] R. B. Mann, "Ten trends in the continuing renaissance of urban waterfronts," *Landscape and Urban Planning*, vol. 16, no. 1-2, pp. 177 - 199, 1988.
- [23] Z. Liu, X. Dong, Z. Liu and Q. Liu, "Waterfront as the Public Space of the City - Research on the Waterfront Park of the North Bund in Shanghai," *Advanced Materials Research*, Vols. 807-809, pp. 1733 - 1736, 2013.
- [24] H. Turkoglu and S. Secmen, "The role of urban waterfront parks on quality of life in İstanbul," *A/Z ITU Journal of the Faculty of Architecture*, vol. 16, no. 1, pp. 53 - 66, 2019.
- [25] J. B. Hollander, "Stakeholder Preferences on a Working Waterfront: Quality of Life, Land Uses and Planning Processes in Chelsea, Massachusetts," in *Handbook of Community Well-Being Research*, Dordrecht, Springer, 2016, pp. 339 - 354.

- [26] J. H. Kain, M. Adelfio, J. Stenberg and L. Thuvander, "Towards a systemic understanding of compact city qualities, "Journal of Urban Design, t. 27, br. 1, pp. 130 - 147, 2022.
- [27] V. Mehta, "The Continued Quest to Assess Public Space, "Journal of Urban Design, t. 24, br. 3, pp. 365 - 367, 2019.
- [28] V. Mehta, "Evaluating Public Space, "Journal of Urban Design, t. 19, br. 1, pp. 53 - 88, 2014.
- [29] N. A. Arghandwal, "The land use change analysis of the walled city in Afghanistan," Urban, Planning and Transport Research, vol. 9, pp. 306 - 318, 2021.
- [30] P. Pereković, "Parkovni elementi kao nositelji rekreacijskog potencijala," Prostor, vol. 25, no. 2, pp. 342 - 357, 2017.
- [31] N. K. Booth, Basic Elements of Landscape Architectural Design, Illinois: Waveland Press, 1983.
- [32] J. Gehl, Life between Buildings, New York: Van Nostrand-Reinhold, 1987.
- [33] M. Hough, City form and natural process, New York: Van Nostrand Reinhold, 1984.
- [34] R. Hart, Children's experience of place, New York: Irvington, 1978.
- [35] J. Hohtenthal, P. Minoia and P. Pellikka, "Mapping Meaning: Critical Cartographies for Participatory Water Management in Taita Hills, Kenya," The Professional Geographer, vol. 69, pp. 383 - 395, 2017.
- [36] F. Bieber, "Local institutional engineering: A tale of two cities, Mostar and Brčko," International Peacekeeping, vol. 12, no. 3, pp. 420 - 433, 2005.
- [37] A. Jeffrey, "Building state capacity in post-conflict Bosnia and Herzegovina: The case of Brčko District," Political Geography, vol. 25, no. 2, pp. 203 - 227, 2006.
- [38] a. B. L. Urbanistički zavod Republike Srpske, Izmjene i dopune Urbanističkog plana grada Brčko (II), Brčko: Vlada Brčko distrikta BiH, 2007.
- [39] A. Akbarov, Linguistic, Culture And Identity In Foreign Language Education, Sarajevo: International Burch University, 2014.
- [40] K. Dovey, Fluid city: transforming Melbourne's urban waterfront, Routledge, 2005.
- [41] R. Sairinen and S. Kumpulainen, "Assessing social impacts in urban waterfront regeneration," Environmental Impact Assessment Review, vol. 26, no. 1, pp. 120 - 135, 2006.
- [42] V. Mathews, "Reconfiguring the breastfeeding body in urban public spaces, "Social & Cultural Geography, t. 20, br. 9, pp. 1266 - 1284, 2019.
- [43] P. Boland Dr., J. Bronte and J. Muir Dr., "On the waterfront: Neoliberal urbanism and the politics of public benefit," Cities, vol. 61, pp. 117 - 127, 2017.
- [44] M. Francis, "Urban Open Spaces, "In: Advances in Environment, Behavior and Design, New York, Springer, 1987, pp. 71 - 106.
- [45] K. Y. K. Dyson, "Ecological design for urban waterfronts, "Urban Ecosystems, t. 18, pp. 189 - 208, 2015.



Ognjen Šukalo, University of Banja Luka, ognjen.sukalo@aggf.unibl.org

Maja Milić Aleksić, University of Banja Luka, maja.milic-aleksic@aggf.unibl.org

Slobodan Peulić, University of Banja Luka, slobodan.peulic@aggf.unibl.org

HOUSING NATURE, REPRESENTING »NATURE«: ARCHITECTURE OF CONSERVATORIES, GREENHOUSES AND THEIR TRANS-PROGRAMMATIC SCIIONS

Abstract

Buildings intended specifically for growing plants – greenhouses, glasshouses, conservatories, orangeries and similar – represent relatively recent addition to the history and repertoire of architecture. In their three centuries of notable existence these structures managed to not only enable cultivation of climatically-exotic plants far away from their natural range, but also to form a particular genre of architecture, which developed through different phases, from high exclusivity to near irrelevance. Starting, not only from historical examples, but also from the general promise of enclosed ecologies, this paper aims both to analyze the phenomenon of greenhouse, as well as to propose directions for its possible further developments.

Keywords: greenhouse, glasshouse, conservatory, nature presentation, programmatic integration

ОКУПИТИ ПРИРОДУ, ПРЕДСТАВИТИ ПРИРОДУ: АРХИТЕКТУРА СТАКЛЕНИХ БАШТИ И ЊИХОВИХ ТРАНС-ПРОГРАМСКИХ НАСЉЕДНИКА

Сажетак

Грађевине намијењене гајењу биљака – стаклене баште, стакленици, оранжерије и сл. – релативно скоро ступају на историјску сцену и у општи репертоар архитектуре. Током своја три вијека постојања овакве структуре успјеле су, не само да омогуће узгајање егзотичних биљака далеко ван њиховог природног станишта, него и да се успоставе као посебан жанр архитектуре, који се развијао кроз више фаза, крећући се између високе ексклузивности и скоро потпуне ирелевантности. Полазећи, не само од историјских примјера, него и од обећања које са собом носе затворене екологије, у овом раду једнако се анализира постојеће стање феномена стакленика, као што се предлажу правци за његов могући даљи развој.

Кључне ријечи: стакленик, стаклена башта, репрезентација природе, програмске интеграције

1. INTRODUCTION: ORIGINS AND RELATIONSHIPS

Relationship between built space and plants is one of the most basic propositions of our experience of the world. Vegetation – or “nature” as it is often simplified to – represents the most basic context for architecture, save for climatic zones of extreme aridity, salinity or cold, and save for environments composed predominantly of built forms. Only sky “surrounds” architecture more often than plants. Still, for the most part of the architectural history, plants and buildings (especially interiors of building’s envelope) very rarely entertained any sort of interconnectedness or close interaction. In classical antiquity such connections, on a grand enough scale and in royal interpretation, even qualified for a “world wonder” [1].

Several reasons for this lack of interaction appear as almost self-evident:

- Built space, as ever, being supremely resource demanding, costly and in short supply;
- Traditional building materials being often incompatible with humidity that larger plant ensembles demand (and also transpire).
- Translucent and transparent materials being (for a very long time) virtually non-existent and, later, very expensive.

Despite these reasons being crucial - and some of the associated problems insurmountable - no less important was also the lack of specific cultural, political and ideological preconditions for emergence of architectural-horticultural spaces. These preconditions have slowly started to emerge with early modern period and rise of two specific socio-cultural phenomena:

- Intense European exploration of the XV and XVI century, together with the fact that these (mostly naval) explorations were focused primarily on geographical areas with climatic conditions warmer than those found in Europe (that is, mostly tropics). From such locations, early (and later) explorers, often with some members of the crew versed in natural sciences, started to bring numerous seeds and live specimens of exotic plant life.
- Rise of the scientific method and worldview and, within it, clear emergence of distinct disciplines such as botany.
- Additionally, new narratives were also called for in the course of greenhouse building revivals of 1960/70’s and 2010’s. For seventies those were narratives of emerging (geo)systemic scientific disciplines, while the most recent impulses relate to either sustainability of food production, or to conservation of biological diversity - in an age of possible serious climatic disruptions.

With these historical conditions met, technological advances in iron and glass manufacturing started to shape the classical glasshouse - or ‘conservatory’ - of the XIX century. Still being very expensive, especially in light of existing glass and window taxations in England, France and other countries of Western Europe [2], the conservatory became the signaling device for wealth and social status. Initially being used for a wide variety of horticultural and social purposes, the glasshouse quickly became prime focus for many botanical institutions, which were in existence for decades and even centuries prior. Large conservatories, glasshouses, palm houses (etc.) were erect in Kew, Paris, Brussels, Copenhagen, Berlin, Vienna, St. Petersburg, New York, as well as in aristocratic estates, especially in Britain [3].



Figure 1. *Glasshouses at the Royal botanical garden Edinburgh [4],*

displaying an array of periods and elements: on the left side is the Temperate Palm House (Matheson, 1858) with substantial part of solid-wall envelope (quite unusual trait for the time, outside of the range of orangeries) and clearstory central nave for the tallest of species. On the photo, the Temperate palm house blocks the view to the octagonal Tropical Palm House (unknown architect, 1834). To the rear, research greenhouses (for nursery production, scientific work etc.) are visible, while the right side of the photograph reveals the Front Range (main glasshouse range, architect G. Pearce, 1960) with its hi-tec structural exoskeleton.

However, this glass-builders peak (exemplified most notably in Paxton's non-horticultural edifice of 1851) lasted only for several decades (approximately from 1830s to 1880s) and it brought forth buildings in relatively narrow stylistic range: cast- and wrought-iron girders, assembled for maximum span, and embellished in high ornamentation (traditional in appearance, but with few precise historical stylistic references) [3].

In this paper we will aim to outline the conceptual boundaries of the phenomenon of horticultural-architectural space, specifically in its version of botany-oriented programmes. We will explore reasons for the short-lived expansion of the XIX century and the logic (and inconsistencies) of the phenomenon's revival of recent decades. Further, we will try to (de)construct the conceptual apparatus for understanding and designing the botanical-architectural space, guided by its history, its general components, by recent examples and by our own design explorations in the field. Moreso, we will propose that there is a specific programmatic and aesthetic field in architecture, which is based on (re)presentation of botanical world. We find compelling reasons to increase clarity in this field, since the inflation of vegetation-related concepts threatens to unnecessarily and regrettably collapse the "bubble" in a similar fashion to the way it has happened at the end of XIX century.

2. DEFINING THE FIELD: CONTROLLED ENVIRONMENT

Great botanical conservatories⁹, as well as their small, private, offshoots are far from being the only – or even representative – forms of plants grown in enclosure. The broadest typology, according to purpose, might be summed up through four broadest designations: general gardening, agriculture, special purposes and botany.

2.1. GENERAL GARDENING

These often combine several purposes, but also remain present in many other types, since interest in the practices of gardening and resulting ambiances are hardly ever absent from precisely designated botanical spaces. However, they do exist as a type in itself, in countless small conservatories, most often private, intended for growing of food, ornamentals and simply for pleasure.



Figure 2. Interior of the Embarcadère Greenhouse, Royal Greenhouses of Laeken (arch. Alphonse Balat, 1874-1890), Brussels: glasshouse designed and used predominantly for enjoyment of garden atmosphere, without any botanical pretensions. [5]

⁹ Note on terminology: "conservatory", "greenhouse" and "glasshouse" can often be used interchangeably, except when the applied materials dictate otherwise. "Glasshouse" is obviously inappropriate when glass is substituted with other translucent material. "Greenhouse" is the most general term, though it has its narrower connotation: small garden structure, often with glass alternatives. Here, interchangeable use is often only due to stylistic requirements of the text.

Historical accounts often mention origins of controlled environment gardening as being the matter of courts and royal wishes and excesses. According to Pliny the Elder [6], physicians of Emperor Tiberius (cca. 30 AD) proposed to the Caesar to eat a certain kind of vegetable (a cucurbite) every day of the year. Imperial gardeners achieved the task by devising carts that were drawn inside buildings by night, drawn outside by day – and on cold days covered with semi-transparent mineral slates (selenite). Much later, in different part of the world (but a few centuries prior to any European example of the age) Korean royalty in 1450's also enjoyed prolonged growing season of citrus trees, housed in structures covered in with *hanji* (specific kind of oiled paper), heated with *ondol* (underfloor heating), with substantial thermal mass of several earthen walls [7].

Proper greenhouses and orangeries started to appear in Western Europe in XVII century, mostly enticed exactly by gardeners (for citrus and other fruits, as well as for apothecaries) [3].

General gardening – for purposes of enhancing ambience and character of architectural spaces – remains today by far the most dominant form of horticultural-architectural space, from modest attached extensions in residential context, through all kinds of “green” embellishments of commercial enterprises (including housing), up to large public projects for new or revitalized spaces.

2.2. AGRICULTURE

Outside of scope of gardening and its multilayered interests, bulk production of food did not converge with controlled environments for very long time. It can be argued that demise of glasshouses as architecture coincides with continued improvements in glass and iron/steel manufacturing, which, especially during last decades of XIX century, democratized ownership of conservatories, thus decreasing its allure as wealth signaling item [8]. These same improvements brought forth opportunities for mass production of food, thus removing almost all practical limits to spread of agricultural controlled environments. The greenhouse escaped the realm of architecture, first into only specific tasks of agriculture and, later, into becoming significant force in shaping entire landscapes - like in Netherlands (where glass as material of choice still dominates) or south Spain (with polyethylene or other kinds of oil-derived translucent materials).



Figure 3. *Landscape dominated by agricultural glasshouses in Westland, Netherlands.*[9]

Past two decades has seen reconceptualization of agricultural greenhouse as particularly useful to architecture. Environmental costs of food production and transportation have made urban environments to be seen as adequate locations for reintegration of urban life with agriculture/gardening. [10] New concepts of “urban farms” emerged, either as mono-thematic or overlapping with other architectural programmes. Up until now, few have been built and put to (effective) production.



Figure 4. *Agrotopia, agricultural greenhouse with visitor and research facilities atop the agricultural market, Oostnieuwkerksesteenweg Roeselare, Belgium (Meta Architectuurbureau and Van Bergen Kolpa Architecten, 2022) [11]*

2.3. SPECIAL PURPOSES

During second part of XX century, specific qualities of light-admitting controlled environments attracted attention for experiments which surpassed individual disciplines such as botany or horticulture. Drawing both from theories of ecological microcosms [12], earth system science and perceived need to develop material and operational basis for outer space colonization, experiments such as Biosphere 2 were established, in which broader (systemic) parameters of general climate, energy circulation, biological productivity and human integration were deemed more important for exploration, than researching and presenting individual species¹⁰. [13]

Light-admitting and heat-retaining enclosed spaces do offer themselves for numerous other tasks, sometimes highly derived and quite innovative. For example, practices of ecological design, originating profusely in 1970's, greatly emphasized potentials of the greenhouse, in many combinations (for example, animal husbandry with entrapment and use of residual animal heat [14]). Perhaps the most interesting, both technically and culturally, is the use of greenhouses for biological wastewater purification. Pioneered by John Todd, these systems used complex assemblies of many kinds of organisms (fungi, algae, bacteria, protozoa, up to molluscs, fish and higher plants). These would be assembled in purification sequences, in order to use up the organic matter in wastewater or bind the inorganic pollutants. Controlled environment envelope would be indispensable for optimal and consistent functioning of such systems, especially in temperate or cold climates [15]. The resulting appearance is that of a multifunctional greenhouse, where plants do dominate in size, but it is not strictly botanical or horticultural structure, but a *biological* one (in a sense of encompassing many kingdoms of life: plants, fungi, animals, bacteria etc.). It is also *ecological* (in a sense of both spontaneous and purposeful arrangements of organisms into interconnected systems). Finally, it is also *technological* (in a sense of having precise tasks, utilitarian boundaries and strict performance parameters). In addition, it represents an object with wider cultural mission: to address usual (mis)understandings about water, pollution, interconnectedness of life, and vitality of natural systems. Todd's work resulted in establishment of several smaller (often experimental) waste water treatment facilities, but it also fundamentally influenced a specific niche in waste water treatment technology. There, plants and glasshouses are being presented as tools for new urban integrations of these formerly unsightly technological facilities.

¹⁰ Biosphere 2 included two research "missions": with human crew being closed inside this ecological microcosm for up to two years, with food production and other life-sustaining systems being set up inside.



Figure 5. *Figure 5. South Pest Wastewater treatment facility (Budapest, 2012, architecture authorship unknown to us): Plants grown in controlled environment assist in the process of aerobic/oxygenated fixed-film waste water treatment.) Photo: paper's first author*

2.4. BOTANY

Botanical greenhouse (*stricto sensu* speaking) represents only a special purpose, if judged by predominance of use – since agriculture and general gardening cover by far the most of space and of individual examples. However, in terms of architectural achievements and paradigm framework, both historical and recent, it is botany (and its adjacent life science disciplines) which define the field.

There is a great degree of overlap between botanical conservatory and the one for general gardening and amenity purposes. Differences are linear, rather than discrete, but the main defining parameter remains probably the level – and the whole narrative – of *information* related to plants and their assemblies. In following sections, we will further explore properties and opportunities of botany-oriented conceptions.

3. BASIC SPATIAL AND MATERIAL PROPOSITIONS

In regards to the way architectural-horticultural spaces are conceived and materialized, we propose relatively simple set of parameters, leaving more complex ones for elaboration on a more conceptual level, as well as for exploration of design possibilities. Controlled environments on the interface of horticulture and architecture can be structured through:

3.1. TYPE AND DEPLOYMENT OF A LIGHT ADMITTING ENVELOPE

3.1.1. Translucent envelope being nonexistent

This possibility pertains, for the most part, to the creation of favourable microclimates through (partial) encirclement of plant-growing space by buildings, free standing walls, depressions in the ground etc. It offers relatively little in terms of increasing critical minimal annual temperatures. (For example, cloudy winter days with little solar gains, followed by clear night sky can result in temperatures similar to those outside of this microclimate.)[16] Still, there are possibilities for advancement of growing conditions on the opposing side of the spectrum: developing extremely warm (and dry) conditions for proper fruiting or flowering of certain species (as well as for avoiding certain plant diseases).

Traditional walled growing enclosures (either ancient or in XIX century intensive urban agriculture) are the principal example, but there are examples of combined use of this approach even in the relatively recent large scale botanical conservatories



Figure 6. Walled orchards in suburbs of Paris, first half of the XX century.[17]

3.1.2. Translucent envelope being auxiliary

Most (older) historical examples revolve around this concept: Tender exotic (or out of season) plants do grow outside in favourable weather conditions, but remain housed under translucent material in colder weather and/or by night. First (large and formal) European solutions for controlled-environment horticulture were *orangeries*, high-ceiling, high-aperture and multiple-door buildings intended for housing citrus (and other) plants during winter or night. During warmer parts of the year plants, in pots, would be carted outside, often to be formally presented in designated park-like spaces adjacent to the building itself.[18] Similar to the previous category, solar orientation of the buildings and yards would be such as to maximize thermal and light gains. Versailles orangerie, designed by Luis Jules Hardouin-Mansart, built from 1684 to 1686, represent one of the most prominent examples of this type of building. Smaller and simpler orangeries of the similar age exist in many other locations, with examples from Kensington (1705, Hawksmoor), Belvedere (Von Hildebrandt, 1714), Kew (1761, Chambers), Kuskowo (Argounov, 1764) and other accros Europe and somewhat later North America. [18]



Figure 7. Orangery at Royal Botanical Gardens Kew (arch. William Chambers, 1761), now serves as a restaurant. [19]

3.1.3. Buildings with (significant) translucent envelope - proper greenhouses.

Since this category comprises the central theme of this paper, here we will only note certain trajectory of change in the nature of the envelope itself: namely the innovation in designs of larger spans and hemispheric spaces. Second part and the end of the XX century saw large botanical conservatories being constructed in some form of geodesic dome, but it also saw acceptance of translucent materials other than glass. Most prominent examples include The Climatron, the greenhouse of the Missouri Botanical Gardens (Murphy and Mackey 1960) and much later the Eden Project (Grimshaw, 2001). These innovations were partially led by ambitions for both greater light penetration and increased energy efficiency: Replacement of heavy glass asks for fewer and smaller construction members, especially since single paneled glass remains unacceptably bad at conserving

heat, while multiple paneled glass elements would add even more to the weight. Advancements can be considerable, such as in the Eden Project, where main hexagonal elements span 11 meters, due to the lightness of ETFE insulated „pillows“ and with proportionally very thin and scarce structural members [20]. New and prominent glass envelopes are still being constructed, however. Remaining issues with thermal properties of glass are addressed either by adequate placement of other elements of envelope (see further: The Great Glass House by Foster and Partners), or by substantially less need for heat conservation (subtropical climate of Singapore's Garden by the Bay, Grant Associates et al., 2006-2012).



Figure 8. *The Eden Project, Cornwall, UK (arch. Nicolas Grimshaw, 2001), the largest public/botanical greenhouse in the world. The envelope is comprised of hexagonal-triangular tubular steel structure, covered with inflated panels made of ETFE (ethyltetrafluoroethylene). [21]*

3.2. TYPE AND DEPLOYMENT OF A NON-TRANSLUCENT (HARD MATERIAL) ENVELOPE

Besides being the important from the point of view of architectural composition, solid (and especially high mass) materials represent the valuable repository of heat, often gained in large quantities on clear days. This thermal mass enables moderation of temperature extremes – an uncommon concern of the XIX century classical conservatories of Europe's temperate and humid North-West, unheeding regarding energy, at the time.

Deployment of hard materials in greenhouses can be structured as following.

3.2.1. None - ground being the only hard material, besides the skeleton

It is worth noting that the relationship of the ground and the upper translucent envelope can vary, from ground being flat, through constructing dug-ins on slopes (properly oriented, as in classic passive solar design of the 1970's), to construction of greenhouses in depression. For example, Nicolas Grimshaw's Eden Project is constructed on top of abandoned kaolin surface mine, While Norman Foster's design for Great Glasshouse of the National Botanic Garden of Wales (2000) creates intentional earth banks on the lower (especially northern) parts of the greenhouse.

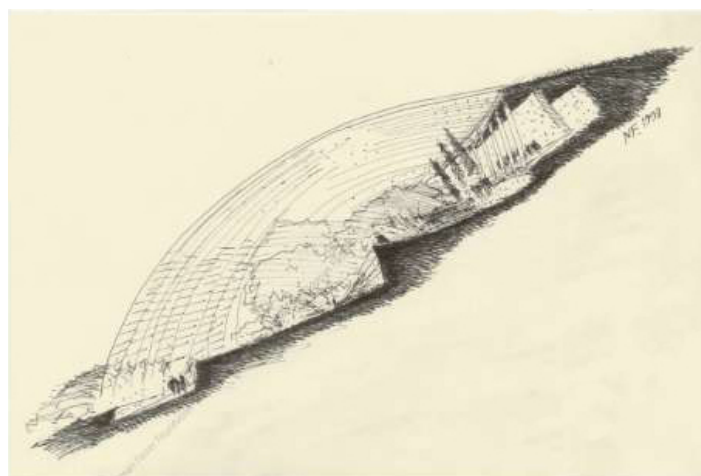

Figure 9. *Norman Foster's sketch for the Great Greenhouse (arch. Foster and Partners, 1995-2000) of the National Botanic Garden of Wales. Ground "envelope" has several indentations across the section, in order to provide opportunities for heat capture and microclimate formation.*

[22]

3.2.2. Hard materials being integrated in the envelope

As a type, classic orangeries, provide the most illustrative range of this integration: from solid materials dominating and forming inconspicuous (non horticulture-related) architecture, to roofs, and other parts of the envelope dissolving into transparent glass domes.

An important design consideration here becomes the ratio of thermal protection (provided by mass) to light penetration (provided, of course, by translucent materials)[16] The aforementioned orangeries – the more enclosed ones - could do away with maximum light penetration due to seasonal nature of their operation. Most of their plants were not tropical and thus had some form of dormant season, which, when acclimatized to temperate climate conditions, could be spent in less than ideally lit buildings.



Figure 10. *(Half)greenhouse, Banja Luka, Republic of Srpska, Bosnia and Herzegovina (arch. papers first author, 2011-2014) during construction of the heat-retaining northern wall and roof structure. Materials: earth, straw, wood, glass. Photo: paper's first author*

3.2.3. Greenhouses attached to other buildings

Here, besides architectural composition (both visual and spatial-programmatic), the main subject becomes the thermal and ambient interdependence between the main (hard material) space and the attachment. Unlike attachment, integration of greenhouse space with that of hard material architecture belongs to different conceptual domain, and in this paper will be explored in following sections.

4. CONCEPTUAL PARAMETERS AND POSSIBLE DESIGN AVENUES

I think one of the big architectural issues of the future is realizing the real significance of plants in human life. And the connection between plants and buildings can only get closer, I think.

Nicolas Grimshaw[20]

Enclosed – architectural that is - spaces admitting enough light and providing enough room for not only plants but their whole assemblies to grow, represent a rare addition to the historical *progress* of architecture – obviously not in a sense of material improvements, but in the sense of paradigm expansion. World of vegetation accepted into the world of *shelter* seems to offer a promise upon which indeed has been acted upon, but whose potentialities have hardly been exhausted.

Based on previously elaborated history and typology, herein we propose a matrix of parameters for design of greenhouses, as fully integrated elements and entities of architecture.

4.1. PROGRAMMATIC INTEGRATION AND SPATIAL DISPERSAL

Despite attached greenhouses being an established genre for considerable time, further integration still remains a fecund possibility – especially in domain of plant assemblies intended for botanical presentations. Botanical conservatories have historically, almost exclusively, tended to be isolated programmes, spaces and forms (and this includes the *attached* version). Modernist as well as more recent attempts certainly made steps toward further integration, but mostly in some form of a ‘great hall’. A decent example of this approach is found in Sheffield Winter Garden (by Pringle, Richards, Sharratt, 2002), while New York’s Ford Foundation (Roche, Dinkeloo, Kiley, 1968) remains one of the earliest - and arguably one of the most successful - integrations of semi-botanical plant assemblies and large, unifying hall-like spaces in buildings not primarily related to plant-presentation or leisure.

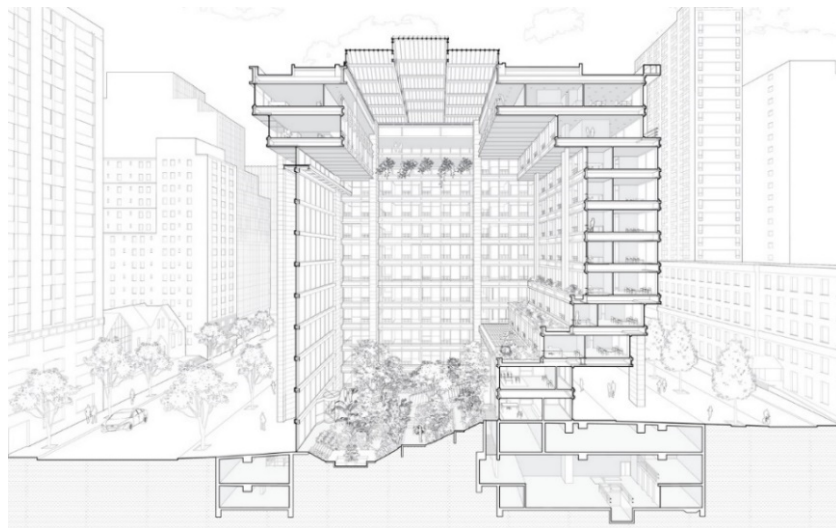

Figure 11. *The Ford Foundation, New York (arch. Kevin Roche, const. John Dinkeloo, 1968), perspective section. [23]*

Indoor botanical presentations have predominantly tended to form ever more isolated units, which was based on both botanical categorization/grouping as well as on needs for maintaining of proper climatic conditions. These conditions can differ strongly in between, for example, spaces devoted to desert plants and those devoted to warm humid environments. Further development of conservatory concepts stressed even more these groupings based on climate, rather than strictly botany. If this tendency to isolate space strictly along “scientific” lines is at least modified then broad opportunities arise to weave botanical narratives with other architectural programmes.



Figure 12. *Concept for the central building of Trapisti Arboretum, Banja Luka (arch. Paper's first author, third author and second author (exact order), 2020). Section through glasshouse and entry space, showing also use of ground indentation for thermal as well as spatial reasons (lowering of building's profile, while increasing the useful height). General spatial disposition, with glasshouse being an integral part of architectural form; its presentational function is continued into the solid envelope, which it transforms through thin clearstory roof opening. Photo: paper's third author.*

4.2. HIGHT VS GROUND

The dimensional range of different plant species is very broad – and it is conceptually relatable to dimensional-programmatic range of human built structures. Great conservatories, both contemporary and historical, have mostly responded to these botanical spatial requirements by creating spaces with balanced spread of ground surface to height – by creating, in the broadest sense, the hemispheric “bubbles”. Variations, in XIX century examples, amounted mostly to incorporation of basilical structural and spatial composition, which allowed for taller plants to stand in central nave, and smaller ones in aisles. Still, geodesic domes of the past several decades contributed to the homogenization of the vertical-horizontal composition of the greenhouse. We believe it can be argued that this insistence on all-encompassing, even-spreading and homogeneous space greatly contributed to architecture of conservatories rarely surpassing its ascribed domain of aristocratic *folie* or scientist's glassed garden. Differences in plant height – and, additionally, in root space requirements – offer a much more diverse and structured palette of elements for architectural

composition. Here, the theme of *ground* shouldn't be overlooked: the rooting space of smaller plants is much more architecturally malleable than the verticality of palms and trees.

4.3. OBJECTS VS LANDSCAPES

Leaving (relatively) small botanical domain aside, we should pay additional attention to the main field of *production of space* in regards to enclosed horticulture – that of sprawling landscapes of agricultural greenhouses. Rather than confining it out of scope of architecture (or viewing it only in terms of the “phenomena” to be researched) these landscapes can be recognized as legitimate context of any architectural incursion. This seems especially valid in light of intensive (controlled environment) agricultural systems near or within urban centers having ever more importance for providing food for growing population. It is in these “seas of glass” that the solid-material architecture can play an organizing role, especially in conjunction with pronounced verticality or visible, out-of-glass, greenery.

5. CONCLUSION

Cultivation of plants in controlled environments – in *greenhouses, conservatories, glasshouses* - has been a very specific programme of architecture since its inception in XVII or XVIII century. Different demands for light (compared to those related to human indoor use) have at first prevented this architecture from emerging, but later, with advancements in iron and glass production, it quickly went to create fully illuminated, completely glazed buildings. These buildings, having their first and highest peak in XIX century, quickly created its somewhat simple and soon irrelevant genre– despite the ethos of the age being very favourable of glass as an instrument of architecture. A certain revival does appear from the 1960's onwards, but with high correlation to new types of construction (geodesic domes) with still little scrutiny given to the exclusivity of glass-only envelope and to the detriments of form based only in geometry. Adoption of the greenhouse in commercial agriculture, with the resulting uncontrolled growth of its use, pushes this type of structure further away from generally accepted realms of architecture and complex design. (Recent explorations of urban agriculture did however provide some renewed interest and relevance.)

Starting with the idea that basic tenants end elements of the *idea of greenhouse* promise substantially more than the history of its implementation has yet managed to provide, in this paper we proposed the structure for understanding this idea, as well as what could be, in our analysis, key design landmarks. Understanding begins with covering of basic domains of appropriate use of controlled horticultural environments, where historical dominants of gardening and agriculture are supplemented with special applications, such as constructed ecological systems for research, wastewater treatment etc. This analysis places the historical flag-bearer – the botanical conservatory – only in ‘special’ category, but, in doing so, implies different quality and potentiality of narratives of botanical/climatic/ecological assemblies compared to those intended only for general gardening/amenity.

Analysis of essential spatial and material propositions determines the typology according to the nature and potentialities of different types of envelopes, starting from the main one – the ground. Distribution of hard envelopes proves to be undeservedly neglected, thus suggesting the direction for possible programmatic and design improvements. However, surpassing the mere remodeling of the mono-programmatic greenhouse, certain opportunities arise for (as of yet) sparsely explored cross-programme *integrations*. As the most promising among many, three conceptual parameters of integration are proposed for further expansion of the field:

- A) rejection of the paradigm of the single, unified and maximized greenhouse space, or, in other words, suggestion for its *dispersion* throughout other spaces and programmes with which enclosed botanical spaces are being integrated;
- B) malleability and expressive potential of markedly vertical plant spaces, along with the horizontal axes and pronounced adaptability of the concept – and spatial distribution – of growing *ground*.
- C) Acceptance of sprawling agricultural *greenhouse landscapes* as a legitimate and interesting contexts for interpolations of solid-materials architecture.

In its most developed conceptual form, controlled environments containing exotic plants – organized and presented precisely as such (as ambassadors of biological and planetary riches from far away) – can play a role of secondary context. It would make for a complete additional layer of natural surroundings added to the one existing in location. It also expands the notion of location, including the orientations according not only to near and far surroundings, but to the place and role of buildings and humans in larger processes of the Earth.

LITERATURE

- [1] Diodorus Siculus. *Bibliotheca Historica*, Book II, section 2.2. Perseus Project, Tufts University. [On-line] Available: <https://www.perseus.tufts.edu/hopper/text?doc=Perseus%3Atext%3A1999.01.0084%3Abook%3D9%3Achapter%3D1%3Asection%3D1>
- [2] The national archives. *Windows tax*. [On-line] Available: <https://www.nationalarchives.gov.uk/education/resources/georgian-britain-age-modernity/window-tax/>
- [3] Woods M., Swartz Warren A., *Glass Houses: History of Greenhouses, Conservatories and Orangeries*. Aurum Press, London [1996]
- [4] Royal botanic garden Edinburgh, *History of the glasshouses*. [On-line] Available: <https://www.rbge.org.uk/collections/living-collection/living-collection-at-the-royal-botanic-garden-edinburgh/glasshouses-history/>
- [5] Grandmont Jean-Pol, CC BY-SA 3.0 licence
- [6] Jones WHS. *Pliny natural history*. Vol. VI. Cambridge, MA: Harvard University Press [1951]
- [7] Yoon, S. J.; Woudstra, J., "Advanced Horticultural Techniques in Korea: The Earliest Documented Greenhouses". *Garden History*. Vol. 35 (1): 68–84, January [2007]
- [8] Stein A., Virts N., *The Conservatory: A Celebration of Architecture, Nature, and Light*, Princeton Architectural Press, New York [2020]
- [9] Hegen Tom, Greenhouse series. [On-line] Available: <https://www.tomhegen.com/collections/the-greenhouse-series>
- [10] Farhangi, M., Turvani, M., Van der Valk, A., Carsjens, G. "High-Tech Urban Agriculture in Amsterdam: An Actor Network Analysis", *MDPI Sustainability*, Vol. 12, 2020 (May 12), 3955.
- [11] Dujardin Filip, [On-line] Available: https://www.vanbergenkolpa.nl/en/552_rooftop_greenhouse_agrotopia.html
- [12] Beyers R. J., Odum H. T., *Ecological Microcosms*, Springer, New York. [1993]
- [13] Nelson M., *Pushing Our Limits: Insights from Biosphere 2*, University of Arizona Press, Tucson. [2018]
- [14] Mollison B., *Permaculture Two*, Tagari, Sister Creek, [1982]
- [15] Todd N. J., Todd J., *From eco-cities to living machines: principles of ecological design*. North Atlantic Books, Berkeley, California. [1994]
- [16] Roesler S., "On Microclimatic Islands", *Les Cahiers de la recherche architecturale urbaine et paysagère*, 6 | 2019, [Online] Available: <http://journals.openedition.org/craup/2712> [accessed 29 December 2019]
- [17] Unknown author. Public domain, Claude Villeteuse personal collection.
- [18] Saudan-Skira S., Saudan M., *Orangeries. Palaces of Glass - Their History and Development*, Tachen, Köln, [1998]
- [19] Evans Benjamin, public domain.
- [20] Grimshaw N., The Eden Project promotional video. [On-line] Available: <https://grimshaw.global/projects/the-eden-project-the-biomes/>
- [21] Matern Jürgen, Creative Commons_licence_BY-SA 2.5
- [22] Norman Foster Foundation Archives. [On-line] Available: https://archive.normanfosterfoundation.org/workspace_and_bonding/es/consulta/registro.do?id=5808
- [23] Lewis P., Tsurumaki M., Lewis D. J., *Manual of Section*, Princeton Architectural Press, New York, [2016]



Milka Šarkanović Bugarinović, University of Novi Sad, milkasb@uns.ac.rs

Aleksandar Ristić, University of Novi Sad, aristic@uns.ac.rs

Željko Bugarinović, University of Novi Sad, zeljkob@uns.ac.rs

Milan Vrtunski, University of Novi Sad, milanv@uns.ac.rs

Dušan Jovanović, University of Novi Sad, dusanbuk@uns.ac.rs

ANALYSIS OF DYNAMIC LOAD OF SIMPLE BEAMS USING GEODETIC AND GEOTECHNICAL SENSORS IN LABORATORY CONDITIONS

Abstract

In this paper, the analysis of the dynamic load of the beam using geodetic and geotechnical sensors was performed. From the group of geodetic sensors, GPS/GNSS receivers were used, while from the group of geotechnical sensors, an accelerometer was used. The measurements were performed in laboratory conditions, and the experiment itself was designed so that the measurements from several series were independent of each other. For the experiment, a construction was made on which all sensors are mounted, which ensures their smooth operation in real time, as well as the setting of different loads. Based on the obtained measurement results, the analysis was performed and conclusions were drawn, as well as the directions of future development.

Keywords: GNSS, accelerometer, beam load, deformation detection

АНАЛИЗА ДИНАМИЧКОГ ОПТЕРЕЋЕЊА ПРОСТЕ ГРЕДЕ ПРИМЕНОМ ГЕОДЕТСКИХ И ГЕОТЕХНИЧКИХ СЕНЗОРА У ЛАБОРАТОРИЈСКИМ УСЛОВИМА

Сажетак

У оквиру овог рада извршена је анализа динамичког оптерећења греде применом геодетских и геотехничких сензора. Из групе геодетских сензора коришћени су GPS/GNSS пријемници, док је из групе геотехничких сензора коришћен акцелерометар. Мерења су извршена у лабораторијским условима, а сам експеримент је осмишљен тако да мерења из више серија буду међусобно независна. За експеримент је израђена конструкција на коју су монтирани сви сензори, а која обезбеђује њихов несметан рад у реалном времену, као и поставку различитих оптерећења. На основу добијених резултата мерења извршена је анализа и донети закључци као и правци будућег развоја.

Кључне ријечи: GNSS, акцелерометар, оптерећење греде, детекција деформација

1. INTRODUCTION

Geodetic and geotechnical sensors are being applied in monitoring of various objects (such as dams, bridges and other constructions) and terrain (e.g. landslides) more and more. In this paper we analyzed the application of these sensors on bridge model in laboratory conditions.

Different types of deformations are inevitable due to material ageing, ecological erosion of the bridge, as well as to increased load by vehicles [1]. Large span bridges are susceptible to external influences, such as strong winds [2, 3], quakes [4], traffic load and temperature changes [5, 6]. Monitoring of dynamic deformations and assessment of bridge condition in real-time are important for providing the load capacity, durability and construction safety, alarming in cases of danger and in prevention of material damage and casualties in extreme conditions [7]. This task, known as Structural Health Monitoring (SHM), is done using different sensors in order to early detect and later mitigate potential damage of the object.

In general sensors can be divided into three groups: geodetic (GNSS/GPS receivers, robotic total stations, etc.), geotechnical (accelerometers, piezometers, extensometers, inclinometers, etc.) and other sensors (temperature, humidity, anemometers, etc.). In this paper GNSS receiver and accelerometers were used. History of development of SHM based on GPS and some examples are described in [8]. GPS-based SHM has evolved from static into dynamic system, and different data processing strategies have been developed as well [8].

GPS provides a great potential for bridge monitoring. Being a very useful sensor follows from several facts [9, 10]:

- Measured values are mutually independent;
- GPS receiver can operate continuously, during day or night-time, regardless of weather conditions;
- High-precision positioning;
- Short observation time;
- Static and dynamic 3D coordinates can be determined concurrently;
- Error cannot be accumulated;
- Receivers are easy to handle.

The development of techniques for dynamic monitoring of bridge movements caused by wind, traffic and temperature changes is described in [9]. Integration of GPS and other sensors for dynamic monitoring is analyzed, e.g. integration of GPS and accelerometers, GPS and robotic total stations. Besides, problems appearing in dynamic monitoring with GPS-based systems are examined (bad satellite geometry, tropospheric and ionospheric delays). Dynamic tests on a series of sine input waves with various frequencies are analyzed in [11]. The results show that the ability to track the signal (oscillations, vibrations) with frequency lower than 2Hz and amplitude higher than 2cm is very good. In this paper, an analysis of the monitoring of the bridge with dynamic loads is conducted. Measurements are done using GPS receivers at the highest frequency, while accelerometer measurements are used as a reference values.

2. SENSORS

In our experiment a combination of geodetic and geotechnical sensors is used. From geotechnical group an accelerometer is used and from geodetic group GPS receivers. Characteristics of used sensors are given in following sections.

2.1. GPS/GNSS RECEIVERS

Global Navigation Satellite System (GNSS) is a satellite navigation system used to determine the position of certain location. It provides reliable data on space and time in all weather conditions, anywhere on Earth or close to Earth, provided that the signal from at least four satellites can be tracked simultaneously. One of basic requirements that have to be met is that there are no obstacles between the satellites and the receiver.

Currently there are several satellite systems, including [12]:

- Global Positioning System (GPS),
- Glonass,
- Galileo,
- Compass, etc.

If the receiver can register signals from all available systems it is called GNSS receiver, although manufacturers do not always follow this convention (e.g. Leica GS15 GNSS receiver cannot register Compass signal, Table 1). Using more systems provides higher accuracy of the measurement [13]. Positioning methods can be static, fast-static, post-processing kinematic (PPK), real-time kinematic (RTK), etc. In this paper a post-processing kinematic method is used. It requires two receivers of similar characteristics. One receiver is a base station that is static during the measurement. Other receiver, called rover is moving during the measurement. The position of the rover is determined relative to the base station. This way measurement errors are greatly reduced. Since base station and rover are very close to each other (few meters), clock errors and atmospheric delays can be neglected [9].

Receivers used in this experiment are Leica GS15 (Fig. 1a) and Trimble R8s (Fig. 1b). Trimble R8s is used as a base station, while Leica GS15 is used as a rover. Rover is rigidly attached to the object, so that there is no movement relative to the object. Trimble R8s has 440 channels and can receive signals from GPS, GLONASS, Galileo, Compass and QZSS satellites [14].

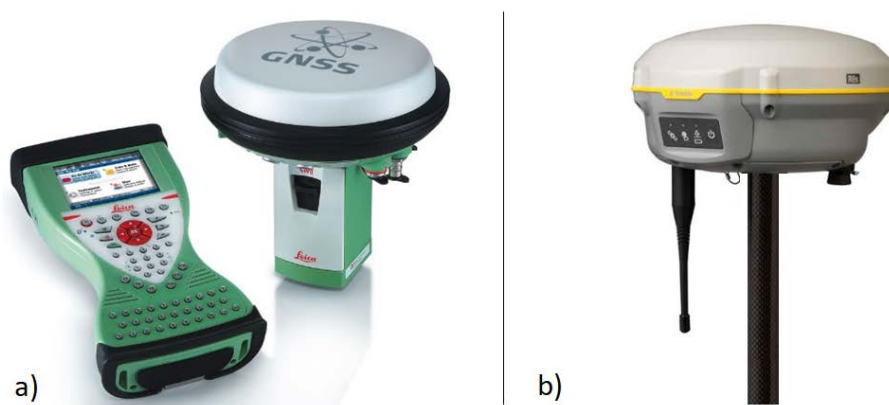

Figure 1. Leica GS15 receiver and Leica CS15 controller (a), Trimble R8s receiver (b)

Characteristics of used receivers are given in Table 1.

Table 1. Leica GS15 and Trimble R8s specifications

	<i>Leica GS15</i> [15]	<i>Trimble R8s</i> [14, 16]
Satellite signals	<ul style="list-style-type: none"> • GPS: L1, L2, L2C, L5 • GLONASS: L1, L2 • Galileo (Test): GIOVE-A, GIOVE-B • Galileo: E1, E5a, E5b, Alt-BOC • BeiDou: B1, B2 • SBAS: Waas, Egnos, Gagan, Msas, Qzss 	GPS: L1C/A, L1C, L2C, L2E, L5 GLONASS: L1C/A, L1P, L2C/A, L2P, L3 SBAS: L1C/A, L5 (for SBAS satellites that support L5) Galileo: E1, E5A, E5B BeiDou (COMPASS): B1, B2 SBAS: QZSS, WAAS, EGNOS, GAGAN
Maximum measurement frequency	20Hz	10Hz
Positioning performance	Post-processing kinematic H . . . 8 mm + 1 ppm RMS V . . . 15 mm + 1 ppm RMS	Post-processing kinematic H . . . 8 mm + 1 ppm RMS V . . . 15 mm + 1 ppm RMS

2.2. ACCELEROMETER

Accelerometer is geotechnical sensor used for precise measurements of oscillations (acceleration) [17]. According to the number of measurement axes they can be single, two and three-axis. In this experiment the two-axis accelerometer ADXL203 is used (Fig. 2).

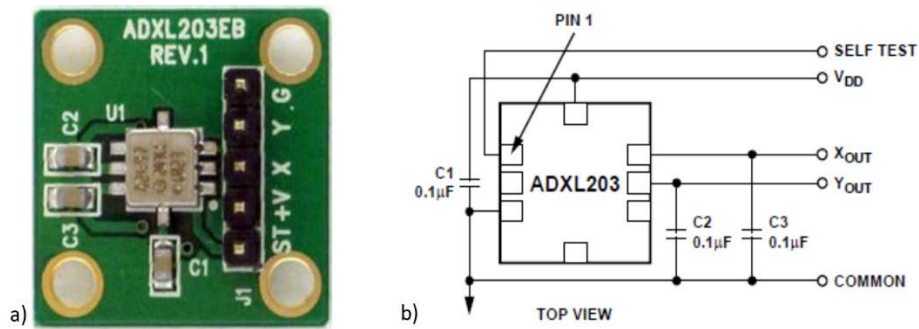

Figure 2. ADXL203 accelerometer (a); ADXL203ED schematic (b)

Accelerometer's sensitivity is inversely proportional to the square of the first resonant frequency [18]. Most important parameters from ADXL203EB datasheet are given in Table 2.

Table 2. ADXL203EB specification

	Value
Measurement scale	$\pm 1.7g$
Linearity	$\pm 0.2\%$ FS
Sensitivity	1000mV/g
Bandwidth	50Hz
Supply voltage	3-6V
Output voltage at 0g	2.5V (supply 5V)

3. EXPERIMENTAL SETUP

An experiment is conducted in laboratory environment to simulate the dynamic load of a single beam (bridge segment/entire bridge). As stated in previous sections GNSS receivers and accelerometer are used, as well as additional equipment. In order to obtain the best possible GNSS signal reception the experiment is conducted on the roof of building of Science and Technology Park (STP) in Novi Sad.

Construction used in experiment is consisted of a wooden beam, 1.30m long, 0.20m wide and 0.008m thick. On one end it is fixed using clamp (Fig. 3b), while the other end is leaned on the desk. Accelerometer is firmly attached to a piece of steel pipe (rectangular cross section), and then to the beam using screws (Fig. 3a). Leica GS15 receiver is placed on the beam using tribrach and carrier. This provides the centering error not greater than 0.2mm. Tribrach is firmly attached to the beam using the screw. On the part of screw beneath the beam a cut is made to enable the placement of the load below the beam (Fig. 4).

Base station, Trimble R8s receiver, is mounted on a 2m long carbon pole, fixed using bipod and placed in the close vicinity of the construction. Different scenarios of beam loading are simulated combining weights of 1kg and 2kg.



Figure 3. Accelerometer, tribrach and GNSS receiver carrier (a), construction with beam and sensors (b)

Schematic of beam construction with installed sensors is given in Fig. 4.

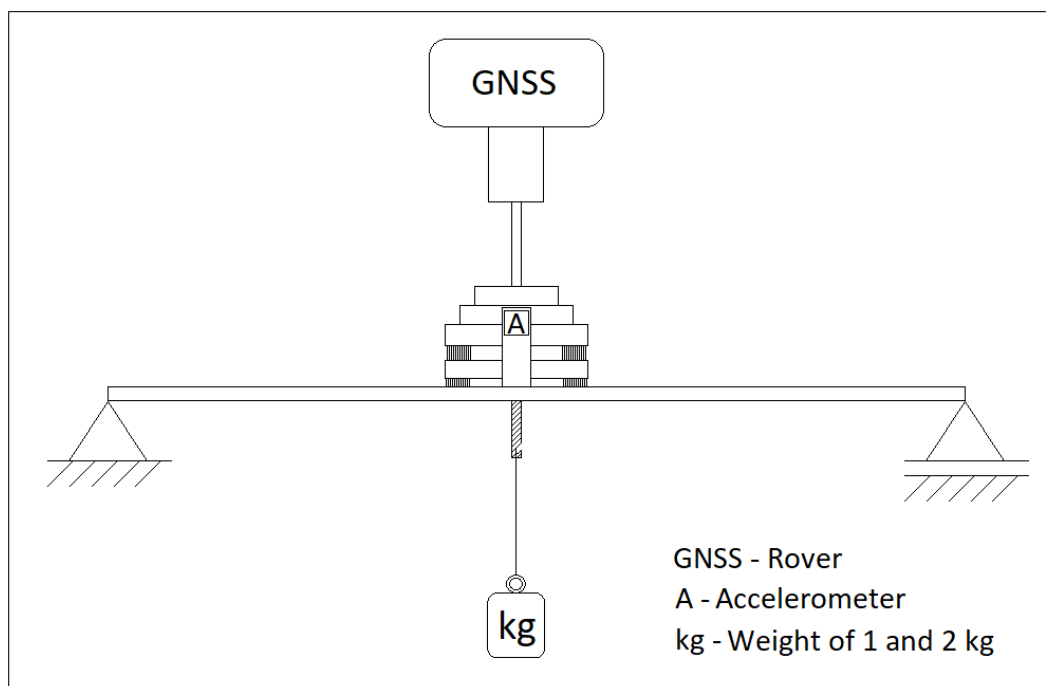

Figure 4. Beam, sensors and load

4. MEASUREMENTS

Experiment includes two series of independent measurements, with different beam loads. Before each measurement the beam is loaded using the weight which is placed below the center point of the beam. Non-elastic thread is used to attach the weight. This way controlled dynamic loading of the beam is obtained. Considering that the weight is hung before the measurement the force is applied to the beam, i.e. the beam is statically loaded.

First series of measurements involved releasing the 1kg weight from 30cm height. Controlled release is obtained using two threads, one of which (the shorter one) is cut. This way the loading of the beam is retained. After the oscillations disappear the beam settles down in its initial state (steady state). Next measurement is conducted after the weight is taken down, threads replaced, and the weight hung again. The fixed end of the beam is checked after each measurement. Main parameters of the measurements are given in Table 3.

Table 3. Measurements setups

Height [cm]	Weight [kg]	GNSS measurement frequency [Hz]
30	1	20
30	2	20

Oscillations induced by different loads are registered using sensors measuring 20 times per second, i.e. 20Hz. Both GNSS receivers enable this rate of measurement. Accelerometer is installed with one axis being vertical, i.e. aligned to Z-axis.

Data obtained from accelerometer represent the acceleration of the beam center point along the Z axis every 0.05s (20Hz), while GNSS data represent the displacement of the center point from its initial position along the Z axis in meters. In order to compare the data, GNSS results are recalculated to acceleration using well known equations [19].

5. RESULTS AND DISCUSSION

Considering that ADXL203 accelerometers provides much higher rate of measurement compared to GNSS receiver, data obtained with this sensor are taken for reference values within this experiment.

Also, it has to be mentioned that all GNSS measurements have fixed solutions, which provides highest accuracy in given environment.

The first test includes loading the beam using 1kg weight free falling from the height of 30cm. The moment of cutting the thread can clearly be seen in Fig. 5. Immediately after this moment the highest value of acceleration amplitude is reached (measured by both accelerometer and GNSS) and afterwards it gradually decays. Values of global maximum and minimum amplitude are approximately equal by both sensors, while local values can be significantly different at various time instances. Accelerometer data show that the beam returns into its rest state in approximately 5 seconds after the loading is applied.

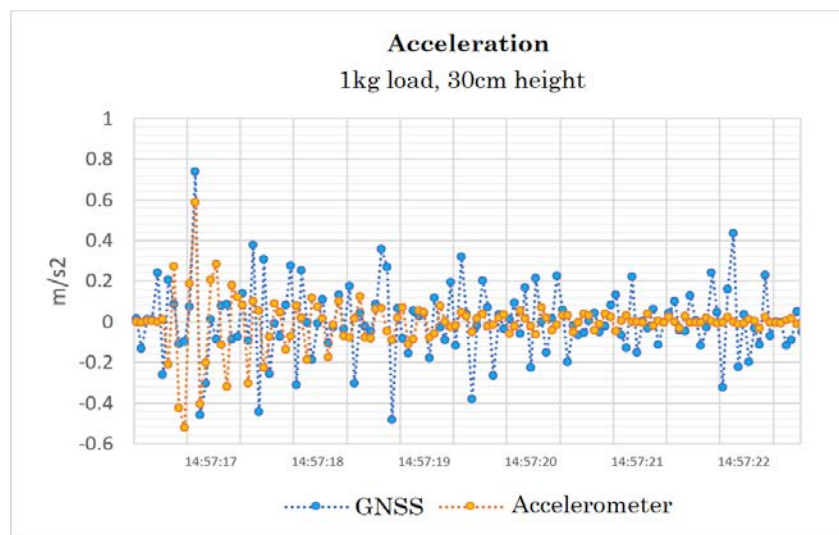

Figure 5. Measured acceleration, 1kg load, 30cm height

Results obtained within the second independent measurement are shown in Fig. 6. Here the beam is loaded with the 2kg weight, at the height of 30cm. In this data maximum value can be seen in the early phase of the measurement. Positive peaks have similar values at both sensors, but the negative peak in GNSS data is significantly higher (in absolute terms) than the negative peak in accelerometer data.

It can be seen that by both accelerometer and GNSS oscillations are detected, but they are more obvious in the curve derived from accelerometer data. These data also show that the beam returns into its rest state in approximately 6 seconds. However, besides global maximum and minimum, in GNSS data local maximum and minimum values are obtained. Therefore it is difficult to determine the moment when the beam returns into its steady state based on GNSS data.

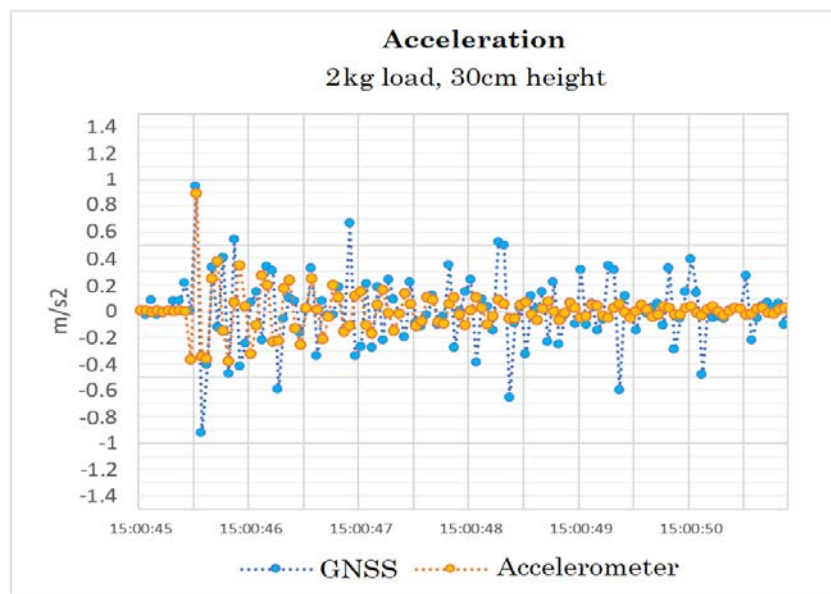

Figure 6. Measured acceleration, 2kg load, 30cm height

Measurement results show that smaller differences are in the case of loading the beam with 2kg weight. Before steady state is established, only in few moments the deviation is larger than 0.2m/s^2 (1kg weight) and 0.4m/s^2 (2kg weight). The biggest issue is in the steady state where GNSS data show that there is still some movement. This can be troublesome in the case of small amplitude oscillations. Longer duration and higher amplitude of oscillations could help to overcome this problem. Global maximum coincides well in both cases. The differences are 18% (1kg weight) and 9% (2kg weight). On the other hand, global minimum coincided better in the case of 1kg weight (8% difference) than in the case of 2kg weight (39% difference). Considering values for both cases the acceleration amplitude is almost twice bigger when the load is doubled. Taken that into account the biggest difference in global minimum should have been present in accelerometer measurements. A new experiment could show whether increasing the measurement rate would correct this issue or not.

6. CONCLUSIONS

Complex structures such as bridges, tall buildings, tunnels etc., require the usage of both geodetic and geotechnical sensors for successful monitoring. In this paper an experiment is conducted simulating controlled dynamic loading of a basic bridge element. Geodetic and geotechnical sensors are placed in the middle of the beam and they continuously measure the displacement (GNSS receiver) and acceleration (accelerometer). Measurements are done in two series, loading the beam with different weights. GNSS receiver is set to its highest measurement rate (20Hz) and all observations have fixed solutions. Even though its measurement rate can be higher the rate for accelerometer is also set to 20Hz in order to provide more adequate comparison. For the same reason the values obtained with GNSS receiver (displacement) are converted to accelerations.

Results obtained in the experiment show that, if 20Hz measurement rate is applied, it is possible to utilize GNSS receiver for displacement measurement in dynamic tests. With 2kg load similar values of global maximum and minimum are measured with both sensors. In both accelerometer measurement series, the transient process and the moment of entering the steady state are clearly visible. This moment is less visible in GNSS measurements, especially when amplitudes are lower. This is a consequence of the error in height measurement in the rest state, which influences the acceleration. More base stations can increase the accuracy of GNSS measurement.

Further experiments could include more elastic or longer beam in order to achieve higher oscillation amplitudes. Heavier loads can be applied as well. Also, an algorithm to filter GNSS data, such as AFEC [12], could be utilized.

LITERATURE

- [1] R. Karoumi, J. Wiberg, A. Liljencrantz, "Monitoring traffic loads and dynamic effects using an instrumented railway bridge," *Engineering Structures*, vol. 27, pp. 1813-1819, Oct. 2005.
- [2] S. De Miranda, L. Patruno, F. Ubertini, G. Vairo, "Indicial functions and flutter derivatives: a generalized approach to the motion-related wind loads," *Journal of Fluids and Structures*, vol 42, pp. 466-487, Oct. 2013.
- [3] A. Kopáček, I. Lipták, J. Erdélyi, P. Kyrinovič, "Structural Health Monitoring of bridges using accelerometers – a case study at Apollo Bridge in Bratislava," *Geonauka*, vol. 3, pp. 9-15, Apr. 2015.
- [4] R.L. Boroschek, M.O. Moroni, M. Sarrazin, "Dynamic characteristics of a long span seismic isolated bridge," *Engineering Structures*, vol. 25, pp. 1479-1490, Oct. 2003.
- [5] S. Montassar, O.B. Mekki, G. Vairo, "On the effects of uniform temperature variations on stay cables," *Journal of Civil Structural Health Monitoring*, vol. 5, pp. 735-742, Nov. 2015.
- [6] N. Martins, E. Caetano, S. Diord, F. Magalhães, Á. Cunha "Dynamic monitoring of a stadium suspension roof: wind and temperature influence on modal parameters and structural response," *Engineering Structures*, vol. 59, pp. 80-94, Feb. 2014.
- [7] H. Jain, A. Rawat, A.K. Sachan, "A review on advancement in sensor technology in structural health monitoring system," *Journal of Structural Engineering and Management*, vol. 2, pp. 1-7, Sep. 2015.
- [8] S.B. Im, S. Hurlbauss, Y.J. Kang, "Summary review of GPS technology for structural health monitoring," *Journal of Structural Engineering*, vol. 139, pp. 1653-1664, Oct. 2013.

- [9] T. Yi, H. Li, M. Gu, "Recent research and applications of GPS based technology for bridge health monitoring," *Science China Technological Sciences*, vol. 53, pp. 2597-2610, Oct. 2010.
- [10] N. She, L. Chen, J. Liu, L. Wang, T. Tao, D. Wu, R. Chen, "A Review of Global Navigation Satellite System (GNSS)-Based Dynamic Monitoring Technologies for Structural Health Monitoring," *Remote Sensing*, vol. 11, pp. 1-45, Apr. 2019.
- [11] Y. Tamura, M. Matsui, L.C. Pagnini, R. Ishibashi, A. Yoshida, "Measurement of wind-induced response of buildings using RTK-GPS," *Journal of Wind Engineering and Industrial Aerodynamics*, vol. 90, pp 1783-1793, Dec. 2002.
- [12] C. Xiong , H. Lu, J. Zhu, "Operational Modal Analysis of Bridge Structures with Data from GNSS/Accelerometer Measurements," *Sensors*, vol. 17, pp. 1-20, Feb. 2017.
- [13] J. Yu, X. Meng, X. Shao, B. Yan, L. Yang, "Identification of dynamic displacements and modal frequencies of a medium-span suspension bridge using multimode GNSS processing," *Engineering Structures*, vol. 81, pp. 432-443, Dec. 2014.
- [14] "Trimble R8s GNSS SYSTEM," Datasheet, 2015.
- [15] "Leica GS10/GS15 User Manual," User Manual, 2009.
- [16] "Trimble R8S GNSS Receiver," User Guide, 2015.
- [17] N. Ravi, N. Dandekar, P. Mysore, M.L. Littman, "Activity recognition from accelerometer data," in *Proc. IAAI*, 2005, pp. 1541-1546.
- [18] S. Kavitha, R.J. Daniel, K. Sumangala, "Design and Analysis of MEMS Comb Drive Capacitive Accelerometer for SHM and Seismic Applications," *Measurement*, vol. 93, pp. 327-339, Nov. 2016.
- [19] R. L. Lehrman, *Physics the Easy Way*. Hauppauge, NY: Barron's Educational Series, 1998, pp. 17-29.



Dragan Lukić, University of Novi Sad, drlukic.lukic@gmail.com
Dragoslav Rakić, RGF Beograd, dragoslav.rakic@rgf.bg.ac.rs
Irena Bašarić Ikodinović, RGF Beograd, irena.basaric@rgf.bg.ac.rs

CONTROL OF SUBSTRUCTURE CONSTRUCTION OF RAILWAYS IN THE REPUBLIC OF SERBIA

Abstract

Control of compaction of natural soil (in excavation) or compacted in the embankment during the construction of roads is one of the basic forms of quality control of the substructure. When building high-speed roads (highways and high-speed railways), the priority is to achieve a high level of control over the performed work. In order to prevent differential settlement (during the construction of the embankment), or to change the volume due to additional compaction of the material, which inevitably leads to deformations, it is necessary to perform optimal compaction of the material. Within this paper, the technical regulations governing the control of compaction in the construction of railway infrastructure in the Republic of Serbia are presented.

Keywords: substructure, technical regulations, embankment, compaction, control

КОНТРОЛА ИЗГРАДЊЕ ДОЊЕГ СТРОЈА ЖЕЛЕЗНИЧКИХ ПРУГА У РЕПУБЛИЦИ СРБИЈИ

Сажетак

Контрола збијености природног тла (у ископу) или збијеног у насипу при изградњи саобраћајница представља један од основних облика контроле квалитета доњег строја. Код изградње брзих саобраћајница (аутопутеви и брза железница) приоритет је постизање високог нивоа контроле извршених радова. У циљу онемогућавања диференцијалног слегања (при изградњи насипа), или промене запремине услед допунског збијања материјала, које неминовно доводе до деформација, потребно је извршити оптимално збијање материјала. У оквиру овог рада приказује се техничка регулатива која регулише контролу збијености при изградњи железничке инфраструктуре у Републици Србији.

Кључне ријечи: доњи строј, техничка регулатива, насип, збијеност, контрола

1. INTRODUCTION

For many years, the railway network of the Republic of Serbia was unmaintained, technically lagging behind the railway networks of surrounding and developed European countries. With the started works of reconstruction and modernization of the railway, there was a need, for various reasons, to build substructure of the railway as high quality as possible, whether it is the reconstruction, rehabilitation of the existing or construction of a new one. As a consequence, there is a significant control of construction, especially compaction.

Taking into account the above, the technical regulations applied during construction were adopted, which are harmonized with the regulations of European countries, as follows:

In 2006, Instructions 338 were adopted for the control of compaction of the substructure of railway tracks by the dynamic method with a light falling weight (Light Weight Deflectometer) device on the JŽ railway network.

In 2012, the Regulations on the design of reconstruction and construction of specific elements of the railway infrastructure of certain main railway lines were adopted ("Official Gazette of the RS", No. 100/2012).

In 2016, the Regulations on technical conditions and maintenance of the substructure of railways were adopted ("Official Gazette of RS", No. 39/2016 and 74/2016).

The paper presents the technical conditions for compaction testing according to the mentioned regulations as well as the state of control applied in practice (during construction). Also, the paper points out the shortcomings of such application of control and the proposal of a possible solution.

2. EXISTING TECHNICAL REGULATIONS

This chapter presents the conditions for controlling the compaction of the protective layer, transition layer, embankment, foundation soil under the embankment and soil control on the part of the railway trunk in the cut.

2.1. INSTRUCTION 338

Table 1. Required values of compaction and degree of unevenness [1:12-12]

Type of railways	Planum of the railway /on top of the protective layer /				Planum of the railway /on top of the transition layer/					
	Rc*	Ev ₂ N/mm ²	Degree of unevenness	Evd N/mm ²	Rc*	Ev ₂ N/mm ²	Soil groups by AC classification	Evd N/mm ²		
C o n s t r u c t i o n	Main arterial route	1,03	120	U>15	50	1,00	80	GU,GP,GW, GF,SP,SW all other soil types	40 35	
	Regional railway	1,00	100	U>15	45	0,97	60	GU,GP,GW, GF,SP,SW all other soil types	35 30	
	Local railway and industrial rails	0,97	80	U>15	40	0,95	45	GU,GP,GW, GF,SP,SW all other soil types	30 25	
M a x i m i z a c i o n	E x i s t i n g	V >160 km/h	0,97	80	U>15	40	0,95	45	GU,GP,GW, GF,SP,SW all other soil types	30 25
		V ≤160 km/h	0,95	50	U>15	35	0,93	20	GU,GP,GW, GF,SP,SW all other soil types	25 20

*in the Instruction Dpr

According to Instruction 338, the conditions for the installation of the protective and transition layer are given. Table 1 shows the required values of the dynamic modulus of deformation E_{vd} together with the required values of the modulus of deformation E_{v2}. Determining the correlation coefficient between the deformation modulus E_{v2} and E_{vd} can be applied in special cases when soil

homogeneity is ensured (by composition, by granulometric composition and moisture) and in statistically reliable research conditions [1:11-11].

2.2. REGULATIONS FOR MAIN RAILWAYS ("OFFICIAL GAZETTE OF RS", NO. 100/2012)

These Regulations define the minimum quality requirements for materials installed in the layers of the substructure. The minimum requirements are prescribed by the values of the degree of compaction Rc^* , ie the values of the deformability modulus E_{v2} whose definition is contained in SRPS U.E1.010, ie in DIN 18134. The criteria to be met by the materials installed in the protective and transition layer are given in Table 2, while the criteria for embankments are given in Table 3.

Table 2. Minimum value of deformability modulus E_{v2} and degree of compaction Rc^* for the protective and transition layer of the substructure [2:37-37]

Type of railways	Planum of the railway protective layer		Transition layer		Minimum thickness constructions safe on frost including the protective layer of the planum		
	E_{v2} (MN/m ²)	Rc^*	E_{v2} (MN/m ²)	Rc^*	Frost action zone		
					I (m)	II (m)	III (m)
Open track tracks, running (through) track and relief tracks	120	1,00	80	1,00	0,50	0,60	0,70
other tracks	80	0,97	45	0,95	0,30	0,40	0,50

Note: Until the detailed zoning of Serbia on frost for all railways within the Corridor X project, adopt zone III of the area of frost for calculations.

*in the Regulations Sd

Table 3. Minimum values of deformability modulus and degree of compaction for embankment [2:37-38]

a) Embankment height $H > 2,00$ m	
Railway planum level	$E_{v2} = 120 \text{ MN/m}^2$
Protective layer	$E_{v2} = 80 \text{ MN/m}^2$
Transition layer	$E_{v2} = 60 - 45^{**} \text{ MN/m}^2$
Below the transition layer to depth 2,0 m	$E_{v2} = 45 \text{ MN/m}^2$ or $Rc^* > 100\%$
Below the transition layer to depth $> 2,0$ m	$E_{v2} = 20 \text{ MN/m}^2$ or $Rc^* > 95\%$
b) Embankment height $H \leq 2,00$ m	
Railway planum level	$E_{v2} = 120 \text{ MN/m}^2$
Protective layer	$E_{v2} = 80 \text{ MN/m}^2$
Transition layer	$E_{v2} = 60 \text{ MN/m}^2$
Below the transition layer	$E_{v2} = 45 \text{ MN/m}^2$ or $Rc^* > 100\%$
v) For the railway in the cut	
Railway planum level	$E_{v2} = 120 - 80^{**} \text{ MN/m}^2$
Protective layer	$E_{v2} = 80 - 45^{**} \text{ MN/m}^2$
Transition layer	$E_{v2} = 45 \text{ MN/m}^2$
Below the transition layer	$E_{v2} = 45 - 20^{**} \text{ MN/m}^2$ or $Rc^* > 95\%$

- *in the Regulations Sd
- values with ** are valid for other tracks, according to the table

- *the degree of compaction R_c^* is applied here on the soil with a maximum grain size of 5 mm, and in relation to the maximum value of the unit weight in the dry state obtained by the experiment of laboratory compaction according to SRPS U.B1.038, ie according to St. Proctor Test.*

The following conditions are defined for the protective and transition layer [2:38-38]:

The protective layer is formed of coarse-grained gravelly soil with a coefficient of uniformity greater than $U = 15$, provided that it does not contain more than 3% of grains up to 0.02 mm in size, which achieves safety against frost. The granulometric composition should meet the filter criteria in relation to the underlying layer. The maximum grain size is up to 60 mm, water permeability coefficient $k \geq 1 \times 10^{-4}$ m/s at the degree of compaction $R_c = 1.0$. The minimum thickness is 0.20 m, and together with the transition layer, it should meet the conditions of safety against frost [2:38-38]. The transition layer is formed of coarse-grained gravelly or sandy soil, provided that at a uniformity coefficient $U \geq 15$ it must not contain more than 3% of grains up to 0.02 mm in size, and at $U \leq 5$ it must not contain more than 10% (Casagrande's criterion). For the intermediate values of the coefficient U , the grain content of fractions smaller than 0.02 mm is determined by linear interpolation [2:38-38].

The material in the transition layer should meet the filter criteria in relation to the underlying layer or to be protected by geotextile filter plastic, defined by the project [2:38-38].

In the zones with water protection of the foundation soil and the surrounding terrain, protective sealing measures are applied both in and outside of the transition layer for the purpose of controlled drainage of polluted water (or other liquids), and according to the pollution protection solution.

The transverse slopes of the planum are 5%, with a protective layer being formed on the embankments up to the edge of the embankment, and in the cuts or railway stations to the facilities for longitudinal drainage [2:38-38].

2.3. REGULATIONS FOR MAINTENANCE OF SUBSTRUCTURE ("OFFICIAL GAZETTE OF RS", NO. 39/2016 AND 74/2016)

These regulations regulates the construction of the substructure with defined criteria.

The compaction and bearing capacity of the earth carcass layers is assessed by the static deformation modulus E_{v2} , which is determined by the test plate, while the control is performed by the dynamic deformation modulus E_{vd} , which is determined by the light falling load experiment with base plate $\varnothing 300$ mm. Technical conditions for the quality of the material installed in the layers of the substructure in terms of the value of the degree of compaction R_c^* , ie the size of the deformation modulus E_{v2} , are determined by the standard SRPS U.E1.010 and SRPS U.B1.047.

When building new and improving and renovating existing railways, the installation of a protective layer is mandatory.

The surface of the protective layer meets the conditions [3:3-4]

- flatness of the soil material layer ≤ 20 mm / 4 m;
- flatness of the stone material layer ≤ 30 mm / 4 m;
- transverse slope of the layer $\geq 5\%$ with a tolerance of up to $\pm 0.4\%$;
- the maximum deviation of the elevation from the projected one is ± 10 mm;
- the minimum thickness of the protective layer is 20 cm, and in the case of thickness > 30 cm it is installed and compacted in two layers.

Load-bearing capacity at the level of the railway planum meets the following requirements:

- for the construction and improvement of open track tracks and main tracks on main railways $E_{v2} > 120$ MN/m², $E_{v2} / E_{v1} \leq 2.2$, $E_{vd} > 50$ MN/m², $100\% \leq R_c^* \leq 103\%$;
- for the construction and improvement of open railway tracks and main tracks on regional railways $E_{v2} > 100$ MN/m², $E_{v2}/E_{v1} \leq 2.2$, $E_{vd} > 45$ MN/m², $R_c^* \geq 100\%$;
- for the construction and improvement of tracks on local railways and secondary tracks on all railways $E_{v2} > 80$ MN/m², $E_{v2}/E_{v1} \leq 2.2$, $E_{vd} > 40$ MN/m², $R_c^* \geq 97\%$

where the ratio $E_{v2}/E_{v1} \leq 2.2$ is valid for E_{v1} less than the minimum value prescribed for E_{v2} .

The protective layer as a filter must have water permeability, and the flow rate cannot be so high that the particles are washed away. To achieve this:

- the diameter of the grain belonging to the ordinate 15% of the granulometric curve of the protective layer must be four times smaller than the grain size in the ordinate 85%, $d_{85} \geq 4 \times d_{15}$; [6:2-2]
- the maximum grain size should be ≤ 60 mm;
- the degree of non-uniformity must be $U = d_{60}/d_{10} \geq 15$;

- the water tightness coefficient should be $K \geq 10^{-4}$ m/s at $Rc^* = 1$, which ensures that the leakage curve should end in a protective layer on the slope of the embankment or drainage ditch at maximum precipitation.

It is necessary to dimension the protective layer to protect the soil from frost. The necessary condition is that $U \geq 15$ does not contain more than 3% of fractions smaller than 0.02 mm, which prevents capillary rise of water and the formation of ice lenses, which causes uplift during formation, and when melting, the track settles.

The protective layer cannot be located in the area of groundwater impact.

The transition layer is a compacted or improved layer made of coarse-grained gravel or sandy material and together with the protective layer forms frost protection [3:4-5].

Clay materials and materials that can be compacted and consolidated cannot be installed in the transition layer.

The surface of the transition layer meets the conditions:

- flatness of the soil material layer ≤ 20 mm/4 m;
- flatness of the stone material layer ≤ 30 mm/4 m;
- transverse slope of the layer $\geq 5\%$ with tolerance up to $\pm 1\%$.

The load-bearing capacity of the transition layer meets the conditions:

- for the construction and improvement of open track tracks and main tracks on main railways $Ev_2 > 80$ MN/m², $Ev_2/Ev_1 \leq 2.2$, $Evd \geq 35$ MN/m², $Rc^* \geq 100\%$;
- for the construction and improvement of open railway tracks and main tracks on regional railways $Ev_2 > 60$ MN/m², $Ev_2/Ev_1 \leq 2.2$, $Evd \geq 30$ MN/m², $Rc^* \geq 97\%$;
- for the construction and improvement of tracks on local railways and secondary tracks on all railways $Ev_2 > 45$ MN/m², $Ev_2/Ev_1 \leq 2.2$, $Evd \geq 25$ MN/m², $Rc^* \geq 95\%$

where the ratio $Ev_2/Ev_1 \leq 2.2$ is valid for Ev_1 less than the minimum value prescribed for Ev_2 .

When creating a transition layer, the following is used:

- capillary rise resistant material;
- unbound aggregate, grain size 0/125 mm;
- percentage of aggregate grains below 0.063 mm $< 12\%$;
- percentage of aggregate grains below 0.02 mm $< 5\%$;
- $U \geq 15$ does not contain more than 3% of fractions smaller than 0.02 mm and $U \leq 5$ does not contain more than 10% of fractions smaller than 0.02 mm.

The material in the transition layer should meet the filter criteria in relation to the underlying one or be protected by the use of artificial filter materials, such as geotextiles.

The load-bearing capacity of the embankment layers, except for the load-bearing capacity at the level of the protective and transitional layer planum, for the construction and improvement of open track tracks and main tracks on main and regional railways meets the conditions [3:5-6]:

- at the level of the embankment planum below the transition layer $Ev_2 > 60$ MN/m², $Ev_2/Ev_1 \leq 2.2$, $Evd \geq 30$ MN/m², $Rc^* \geq 100\%$;
- at the level below the embankment planum to a depth of ≤ 2.0 m $Ev_2 > 45$ MN/m², $Ev_2/Ev_1 \leq 2.2$, $Evd > 25$ MN/m² or $Rc^* > 100\%$;
- at the level below the embankment planum for depths > 2.0 m $Ev_2 > 20$ MN/m², $Ev_2/Ev_1 \leq 2.2$, $Evd > 20$ MN/m² or $Rc^* > 95\%$;
- for railways in the cut $Ev_2 > 45$ MN/m², $Ev_2/Ev_1 \leq 2.2$, $Evd > 25$ MN/m² or $Rc^* > 95\%$

where the ratio $Ev_2/Ev_1 \leq 2.2$ is valid for Ev_1 smaller than the minimum value prescribed for Ev_2 .

The load-bearing capacity of the embankment layers, except for the load-bearing capacity at the level of the protective and transition layer, for other tracks and local railways meets the conditions:

- at the level of the embankment before the transition layer $Ev_2 > 45$ MN/m², $Ev_2/Ev_1 \leq 2.2$, $Evd \geq 25$ MN/m², $Rc^* \geq 100\%$;
- at the level below the embankment planum to a depth of ≤ 2.0 m $Ev_2 > 45$ MN/m², $Ev_2/Ev_1 \leq 2.2$, $Evd > 25$ MN/m² or $Rc^* > 100\%$;
- at the level below the embankment planum for depths > 2.0 m $Ev_2 > 20$ MN/m², $Ev_2/Ev_1 \leq 2.2$, $Evd > 20$ MN/m² or $Rc^* > 95\%$;
- for railways in the cut $Ev_2 > 20$ MN/m², $Ev_2/Ev_1 \leq 2.2$, $Evd > 20$ MN/m² or $Rc^* > 95\%$

where the ratio $Ev_2/Ev_1 \leq 2.2$ is valid for Ev_1 smaller than the minimum value prescribed for Ev_2 .

Embankment materials must also meet the conditions:

- maximum aggregate grain size ≤ 300 mm;

- maximum aggregate grain size $\leq 2/3$ of the thickness of the layer being performed;
- chemical stabilization is used to improve the load-bearing capacity of the material.

The foundation soil planum must meet the geometric requirements [3:6-6]:

- flatness of the soil material layer 30 mm/4 m;
- flatness of the stone material layer 50 mm/4 m;
- transverse slope of the layer $\geq 5\%$ with a tolerance of $\pm 1\%$;
- the maximum allowed deviation of the elevation of the planum of the foundation soil from the projected elevation is ± 2.5 cm for soil or improved soil, and ± 4.0 cm for cuts in the rock mass.

The required degree of compaction of the foundation soil R_c^* should be higher than:

- 98% for a layer ≤ 0.5 m below the planum of the railway;
- 95% for a layer $0.5 \leq 2.0$ m below the planum of the railway;
- 92% for a layer > 2 m below the planum of the railway.

The load-bearing capacity of the foundation soil under the embankment meets the conditions:

- below the upper surface of the embankment to a depth of ≤ 1.0 m $Ev_2 > 45$ MN/m², $Evd > 25$ MN/m²;
- below the upper surface of the embankment for depths ≤ 2.0 m $Ev_2 > 20$ MN/m², $Evd > 20$ MN/m².

If the embankment is not made, usually on the part of the railway body in the cut, at the level of the foundation soil, the conditions prescribed by Article 7a para. 3 and 4 of this regulation for the transition layer.

*in the Regulations Dpr

3. ADOPTED PRACTICE OF CONTROL OF COMPACTIONS, SHORTCOMINGS AND PROPOSED SOLUTION

In the last few years, the Republic of Serbia has been working on the reconstruction of existing railways, construction of new high-speed railways, and especially on the construction of a large number of industrial tracks for the economy needs. Almost as a rule, the control of embankment construction is performed only by determining the dynamic deformation modulus Evd , and without determining the degree of compaction Dpr and determining the correlation coefficient between Ev_2 and Evd as well as the ratio Ev_2/Ev_1 . Also, when testing with a light drop weight, the required moisture is not checked, and testing of layers is not performed in the same height profile, so the obtained results cannot be compared by layers.

This practice of compaction control and substructure construction is not in line with existing regulations. The consequences of such tests often lead to the degradation of the substructure, which results in the need to repair and reduce the speed.

It is an indisputable fact that this test method is used as faster one in the world, but it is carried out with other tests: determination of Dpr , water content, correlation relations Ev_2/Ev_1 , correlation between Ev_2 and Evd , determination of degree of unevenness, coefficient of water resistance (for protective layer).

In the Republic of Serbia, this test method is not yet standardized (so the ASTM E 2835 standard is used) and can be applied only in correlation with standardized methods. According to the provisions of the mentioned Instruction and the Regulations of testing, determination of the dynamic modulus of deformation, Evd is obligatorily performed along with other tests and the stated correlation relations. Due to the fact that it is not standardized in the Regulations for main railways, tests by determining the dynamic modulus of deformation Evd are not even listed, so based on the application of these Regulations, they are not even authoritative. Applying only this method, which has a high percentage of subjectivity (depending on the expertise of the examiner) can have a number of negative consequences, some of which are listed. This should be especially kept in mind when building high-speed railways (with speeds higher than 200 km/h) because here the consequences can be much greater.

In order to speed up the testing process, the authors of this paper propose the following methodology:

- determine profiles for testing according to the standard and technical conditions (harmonized with the standard)
- determine in examination process the zone where soil homogeneity is ensured (by granulometric composition and moisture) and in statistically reliable research conditions. Perform the necessary tests and correlations and, based on them, perform further tests with a

4. CONCLUSION

The aim of the author of this paper is to present the state of regulations related to the construction of the railway substructure in the Republic of Serbia. In addition, the paper points out the increasing practice of non - compliance with existing regulations and the possible consequences.

Therefore, it is necessary that the tests of embankment construction, especially for high-speed railways, are clearly defined in the project documentation (geotechnical study, technical report, technical conditions, bill of quantities and estimate of works and graphic details).

During the construction, internal and external control tests are required, based on the stated technical documentation. The important role of the responsible contractor and responsible professional supervision should be emphasized.

Very often in practice (in court disputes), designers, responsible contractors and professional supervisors are prosecuted for the consequences of a poorly constructed facility. It is necessary to add controllers to this list, because it often happens that all test results are in accordance with the required values, and the facility is poorly built and requires repair work. The question is how this is possible. There are several answers to this question: the use of inadequate materials that do not meet the required criteria, so the results are often falsified, not enough control tests are performed, which are often not adequate. Therefore, the responsibility of the control performer is great.

In this paper, the authors proposed the possibility of speeding up the testing process with a clear procedure that includes compliance with existing regulations.

LITERATURE

- [1] Instructions 338 were adopted for the control of compaction of the substrate of railway tracks by the dynamic method with a device with a light falling weight on the JŽ railway network, Official Gazette ZJŽ No. 1/2006, Belgrade, Serbia, 2006.
- [2] Regulations on the design of reconstruction and construction of certain elements of the railway infrastructure of certain main railway lines were adopted, Official Gazette of the RS, No. 100/2012, Belgrade, Serbia, 2012.
- [3] Regulations on technical conditions and maintenance of the substructure of railways were adopted, Official Gazette of RS, No. 39/2016 and 74/2016, Belgrade, Serbia, 2016.
- [4] S. Lehmann, 'Investigation of the correlation between static and dynamic plate load tests,' BSc thesis, Technische Universität Darmstadt, Germany, 2011.
- [5] P. Anagnosti and M. Rašula, 'Application of German railways regulations on use of falling weight testing device for assessment of soil compactness,' in Proceeding of International conference Geotechnical aspects of Construction, 2005, pp. 469-472.
- [6] D. Rakić, I. Basarić Ikodinović and M. Ljubojev, 'Filter rules for soil and geosynthetics,' Mining and Metallurgy Engineering Bor, No. 1-2, pp. 1-12, 2021.



Vasko Gacevski, University in Skopje, gacevski@gf.ukim.edu.mk
Riste Ristov, Ss. Cyril and Methodius University in Skopje, ristov@gf.ukim.edu.mk
Ivona Nedevska, Ss. Cyril and Methodius University in Skopje, nedevska@gf.ukim.edu.mk
Zlatko Zafirovski, Ss. Cyril and Methodius University in Skopje, zafirovski@gf.ukim.edu.mk
Slobodan Ognjenović, Ss. Cyril and Methodius University in Skopje, ognjenovic@gf.ukim.edu.mk

COMPARATIVE ANALYSIS OF EXCAVATION AND TUNNEL SOLUTIONS FOR THE ROAD DRENOVO - RAEC

Abstract

When withdrawing the route of the expressway Drenovo - Raec, the axis of the road is forced to stretch near or through the mountain massifs. This created a general dilemma, whether to make classical excavations or tunnel constructions in certain locations. Considerations were also made for the decision on high embankments or viaducts. The characteristic location presented in this paper is located between the existing national road and the river Raec. For this location, a comparative analysis of the variant solutions for excavation and tunnel was made and the main parameters that affect the final solution were indicated.

Keywords: road, route, excavation, slopes, tunnel, analysis.

КОМПАРАТИВНА АНАЛИЗА ИСКОПА И ТУНЕЛСКЕ РЕШЕЊА ЗА ПУТ ДРЕНОВО - РАЕЦ

Сажетак

Приликом повлачења трасе аутопута Дреново - Раец, осовина је принуђена да се протеже у близини или кроз планинске масиве. То је створило општу дилему да ли на одређеним локацијама радити класичне ископе или тунелске конструкције. Разматрано је и о одлуци о високим насипима или вијадуктима. Карактеристична локација приказана у овом раду налази се између постојећег магистралан пут и реке Раец. За ову локацију урађена је упоредна анализа варијантних решења за ископ и тунел и назначени су главни параметри који утичу на коначно решење.

Кључне ријечи: пут, траса, ископ, косине, тунел, анализа.

1. INTRODUCTION

The intensive construction of the road infrastructure in Macedonia started with the realization of the project A1 Prilep - Gradsko. As part of this project, three sections have been developed, two of which are full expressway, and the middle section is a three-lane road.

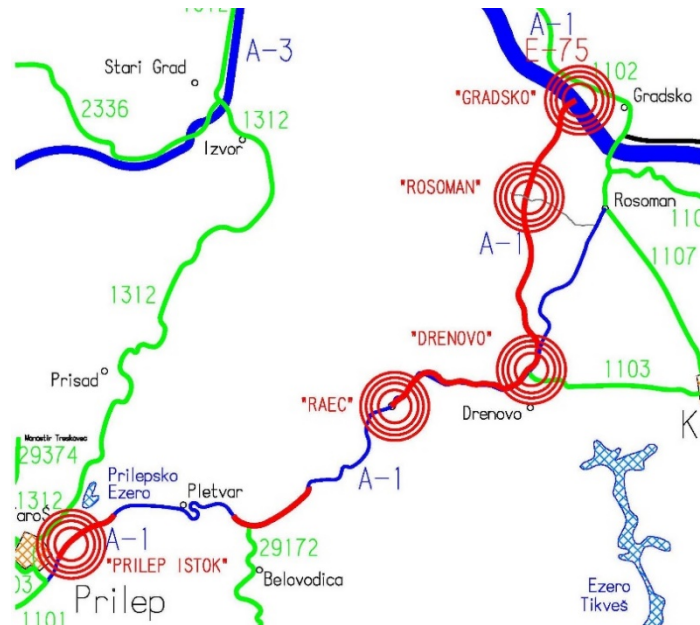

Figure 1. Overview map of sections

The critical section which is analyzed is the section between Raec and Drenovo. The length of this section is 7 km and the road is a reduced highway with the total width of both roads of 25.4 m. The reason for this solution is the possibility for physical separation of the roads in the part of the tunnel constructions.

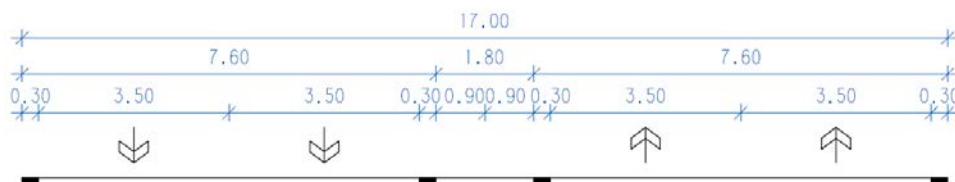

Figure 2. Geometric cross section

Characteristic of this part is that the axis must pass through a narrow gorge. The subject section that is being analyzed is right next to the beginning of the route between two bridge constructions which are two fixed points through which the route must pass. It should be noted here that the area where the analysis is done belongs to the highest environmental protection area (at the level of national parks).

2. DESIGN SOLUTIONS

With the geological characteristics and the disposition of the route, it is possible to prepare two variant solutions with complete excavation with a height of over 40 m and a tunnel solution with a middle overlay of about 30 m. The geological profile of the terrain at this location consists of three zones:

- Zone 1 - strongly cracked to crushed limestone;
- Zone 2 - weakened limestone;
- Zone 3 - relatively compact limestone.

2.1. DESIGN SOLUTION 1 - EXCAVATION

With this Technical Solution, the subject zone is designed as a classic cut, by applying the necessary measures for stabilization and protection of the slopes, ie designing the geometry of the slopes in

accordance with the analysis and calculations and their protection. Due to the fact that the excavation is unusually high, the first and last berm (seen from below) are widened by 2 m, for safety reasons, but also to reduce the negative visual effect when driving, ie to get the impression that it is an excavation with lower height. The excavation is 170 m long with a slope of 5:1, and the berms are 9 m high and 3 m wide. The protection of the slope from surface landslides is planned to be performed with a steel mesh, anchored at the top of the slopes and additionally tightened with finishing weights in the lower part. On the higher side of the terrain, a concrete trapezoidal ditch with dimensions 0.5x0.5x0.5m is provided with sufficient capacity to receive surface water from the surrounding terrain [1]. When making this solution, there is no need to expand the separation lane and on this part the profile will remain with a fixed width as the cross-section profile shown above (Figure 2).

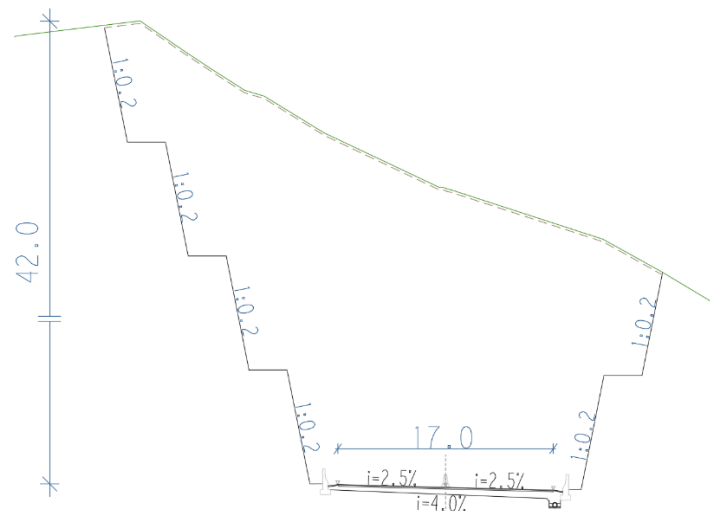

Figure 3. Cross section excavation profile

2.2. DESIGN SOLUTION 2 - TUNNELS

The second project solution consists of two tunnel pipes with an average length of 145 m. The tunnels have a longitudinal slope of 0.3% and a maximum transverse slope of 2.5%. The width of the lane is 2x3.5 m and the edge lanes on both sides are 2x1.00 m. According to the Bieniawski Tunnel Classification (RMR - System), rock masses in these sections are classified into categories III and IV. Several types of substructure are envisaged including: anchors, sprayed concrete, steel arches and final concrete cladding. The New Austrian Tunneling Method (NATM) has been chosen as the general method for tunnel construction. The entrance-exit portals are made with Cut & Cover up to the first 20 m, with a slope of the portal slopes of 3: 1. The project tunnel solution also includes two classic retaining walls located on the outside of the tunnel pipes to the terrain [2].

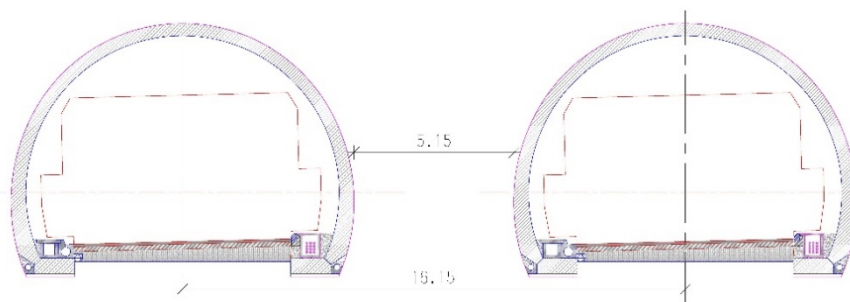

Figure 4. Cross section of tunnel solutions

3. COMPARATIVE ANALYSIS OF VARIETY SOLUTIONS

The following factors are taken into account in the comparative analysis: performance, maintenance, safety and environmental impact. The comparison is made for the same climatic-hydrological conditions, the same traffic load and the possibility of performance by parties. The analysis is made by assessing the advantages and disadvantages of both variant solutions.

3.1. EXCAVATION

3.1.1. Advantages

- Easy, fast and relatively safe performance;
- No need for specialized mechanization and staff;
- The projected part of the route in the situational solution remains the same;
- It is not necessary to redesign the facilities that are adjacent to that part of the route;
- Satisfactory safety in the exploitation phase.

3.1.2. Disadvantages

- Increased excavation;
- Need for new landfills;
- Unfavorable visual effect; Possible additional means for protection of the slopes from erosion;
- Increased means for maintenance, in terms of local landslides in conditions of high waters and winter maintenance;
- Additional expropriation;
- Adverse environmental impacts.

3.2. TUNNELS

3.2.1. Advantages

- Minimal excavation;
- No need for additional landfills;
- High reliability in the exploitation phase;
- Minimal maintenance;
- No further expropriation;
- Beneficial impacts on the environment.

3.2.2. Disadvantages

- Increased risk in the construction phase;
- Specialized mechanization and staff;
- Short distance between tunnel pipes (which affects increased costs);
- Difficulties in construction of the entry-exit portals;
- Increased construction time;
- Necessary relocation of adjacent structures (bridges, viaducts);
- The designed road axis changes;
- Higher cost for construction;
- Additional operating costs for electricity supply and substation.

3.3. ADOPTED SOLUTION

Both solutions have certain advantages and disadvantages, and in terms of the financial part, the tunnels are about 10% more expensive than the excavation. But although the difference in cost is greater and the time period for construction is longer, here the biggest factor for the final decision will be the one for the environment. Thus, the final solution that would pass the route through the hilly massif is a tunnel.

4. CONCLUSION

From the presented comparative analysis between a classic excavation and a two-pipe tunnel solution, it can be seen that from a financial and time point of view the excavation is a more acceptable solution, but since the most important factor in the final decision is the environmental impact, the more expensive solution is adopted. The final decision for the adopted solution should be made in coordination with the Consultant / Auditor and the Investor. According to the specific example, the following general conclusions can be drawn:

- The choice between two or more solutions, whether it is a comparison between an excavation-tunnel or an embankment-bridge, one should always make an appropriate analysis and consider all relevant factors that would influence the solution;

- In the analysis, the most important factors required in the given situation should be defined first, whether it is a financial, time, safety or environmental aspect;
- It is best to make such analyzes at an early stage of the design, to avoid any unforeseen effects on the project;
- The determination of the final geometry of the road should follow after the adoption of the solution from the comparative analysis.

LITERATURE

- [1] Conceptual design for expressway A1 Prilep-Gradsko, Section Raec-Drenovo, 2011.
- [2] Conceptual design for tunnel at the expressway A1 Priler-Gradsko, Section Raec-Drenovo, 2013.
- [3] A. Sev, "A comparative analysis of building environmental assessment tools and suggestions for regional adaptations", *Civil Engineering and Environmental Systems*, Vol. 28, No. 3, pp. 231-245, September 2011.
- [4] B. Rihoux, C. C. Ragin, *Configurational comparative methods: Qualitative Comparative analysis (QCA) and realated techniques*, Applied Social Research Methods Series: Volume 51, SAGE Publications, 2009.
- [5] European commision project: Assessment of unit costs (standard prices) of rail projects (CAPital EXpenditure), Annex 13 – Case study on tunnels, 2018.
- [6] R. Tatiya, *Civil Excavations and Tunnelling – A practical guide*, second edition, ICE Publishing, 2017.

60

Professional paper | Стручни рад
DOI 10.7251/STP2215613V
ISSN 2566-4484



Radovan Vukomanović, University of Banja Luka, radovan.vukomanovic@aggf.unibl.org
Slobodan Popadić, INK Constructor, popadicslobodan1990@gmail.com
Snježana Milovanović, University of Banja Luka, snjezana.milovanovic@aggf.unibl.org

CRANE GIRDER DESIGN ACCORDING TO EUROCODE – NUMERICAL EXAMPLE OF A CRANE GIRDER IN A HYDROPOWER PLANT

Abstract

With the adoption of Eurocodes in the field of civil engineering in Bosnia and Herzegovina, analysis of structures becomes more complex compared to previous regulations. Consequently, the analysis of crane track girders becomes more detailed, with a higher degree of analysis controls during dimensioning. This paper presents the load analysis and design checks of crane girders for ultimate limit state and serviceability limit state, according to Eurocode, with the presentation of the most important parameters and design limitations, such as load classifications, dynamic coefficients, limitations for serviceability states. Furthermore, a numerical example of a crane track support for a bridge crane in the machine building of a 25t hydropower plant is given.

Keywords: crane girder, load analysis, ULS, SLS, Eurocode

ПРОРАЧУН НОСАЧА КРАНСКИХ СТАЗА ПРЕМА ЕВРОКОДУ – ПРИМЈЕР КРАНА У МАШИНСКОЈ ЗГРАДИ ХИДРОЕЛЕКТРАНЕ

Сажетак

Увођењем Еврокодова у области грађевинарства у Босни и Херцеговини, прорачуни конструкција постају сложенији у односу на досадашње прописе. Сходно томе и прорачун носача кранских стаза постаје детаљнији, са већим степеном прорачунских контрола приликом димензионисања. У овом раду приказана је анализа оптерећења и димензионисање кранских носача за гранична стања носивости и употребљивости према Еврокоду, са приказом најважнијих параметара и прорачунских ограничења, као што су класификације оптерећења, динамички коефицијенти, ограничења за стања употребљивости. Дат је нумерички примјер носача кранске стазе за носну дизалицу у машинској згради хидроелектране носивости 25t.

Кључне ријечи: носач кранских стаза, анализа оптерећења, ГСН, ГСУ, Еврокод

1. УВОД

Различити типови кранова имају широку примјену у индустријским објектима за транспорт терета у склопу технологије производње, или за транспорт дијелова механизма и машина приликом сервисирања и ремонта. Обзиром на величину терета као и начина транспорта постоји неколико различитих типова кранова. С аспекта прорачуна кранских носача грађевинским прописима су обухваћени кранови који се крећу по горњој фланши кранских носача, кранови који се крећу по доњој фланши кранских носача, монорејл дизалице, мосни кранови. Увођењем Еврокодова у области грађевинарства, као и за друге типове конструкција, прорачун кранова постаје детаљнији, са већим степеном прорачунских контрола приликом димензионисања у односу на претходно важеће прописе за челичне конструкције. Прорачун кранских носача обухваћен је Еврокодом 3 – Прорачун челичних конструкција – Дио 6: Носачи кранских стаза (ЕН 1993-6). Осим Еврокода 3, оптерећења од кранова дефинисана су у Еврокоду 1 – Дејства на конструкције – Дио 3: Дејства усљед кранова и машина (ЕН 1991-3). У овом раду приказана је анализа оптерећења и димензионисање кранских носача за гранична стања носивости и употребљивости према Еврокоду кроз примјер носача кранске стазе за мосну дизалицу у машинској згради хидроелектране носивости 25t, за потребе монтаже/демонтаже и ремонта турбинско-генераторског постројења.

2. АНАЛИЗА ОПТЕРЕЋЕЊА И ПРОРАЧУНСКЕ КОМБИНАЦИЈЕ ПРЕМА ЕВРОКОДУ

2.1. ОПТЕРЕЋЕЊА

Оптерећења крана можемо подијелити на сопствену тежину крана (Q_c) и тежину терета који се диже (Q_n), а према начину дјеловања могу бити статичка и динамичка оптерећења. Еврокод утицај кранова разматра као промјенљива и инцидентна дејства која подразумијевају како вертикално оптерећење од сопствене тежине и терета тако и хоризонтална оптерећења усљед покретања крана, кочења и закошења кранског моста при кретању, те удар крана или мачке у одбојнике и удар терета приликом подизања у препреке. Динамички карактер дејства који је посљедица вибрација и дејства инерцијалних сила при кретању крана узима се као квази-статичко оптерећење увећањем силе са динамичким коефицијентом. [4]

$$F_{\phi,k} = \phi_i F_k \quad (1)$$

гдје је:

$F_{\phi,k}$ карактеристична вриједност оптерећења од крана,

F_k карактеристична вриједност статичког оптерећења,

ϕ_i динамички коефицијент.

Табела 1. Динамички коефицијент ϕ_i [1]

Динамички фактор	Утицаји који се разматрају	Примјена
ϕ_1	Побуда конструкције крана усљед подизања терета са тла	Сопствена тежина крана
ϕ_2	Динамички утицаји усљед подизања терета са тла до крана	Терет који се диже
ϕ_3	Динамички утицаји усљед наглог испуштања терета када се користе кљешта или магнет	Терет који се диже
ϕ_4	Динамички утицаји усљед кретања крана по шинама или кранској стази	Сопствена тежина крана и тежина терета који се диже
ϕ_5	Динамички утицаји изазвани погонским силама који се јављају при кретању или кочењу крана по шинама (хоризонталне попречне и подужне силе)	Погонска сила
ϕ_6	Динамички утицаји од пробног оптерећења	Пробно оптерећење
ϕ_7	Динамички утицаји при удару у одбојнике	Сила удара

Истовремено дејство више оптерећења од крана узима се у обзир кроз групе оптерећења које су дате у Табели 2. Свака од наведених група сматра се карактеристичним оптерећењем и комбинује се са осталим врстама оптерећења на конструкцију.

Табела 2. Групе оптерећења и динамички коефицијенти [1]

Дејство		Групе оптерећења									
		Гранична стања носивости							Пробно опт.	Инцидентно опт.	
		1	2	3	4	5	6	7			
Сопствена тежина крана	Q_c	φ_1	φ_1	1	φ_4	φ_4	φ_4	1	φ_1	1	1
Тежина терета	Q_h	φ_2	φ_3	-	φ_4	φ_4	φ_4	η^*	-	1	1
Убрзање и кочење крана	H_i, H_t	φ_5	φ_5	φ_5	φ_5	-	-	-	φ_5	-	-
Закошење крана	H_s	-	-	-	-	1	-	-	-	-	-
Убрзање и кочење „мачке“ или колица	H_{T3}	-	-	-	-	-	1	-	-	-	-
Вјетар	F_w	1	1	1	1	1	-	-	1	-	-
Пробно оптерећење	Q_T	-	-	-	-	-	-	-	φ_6	-	-
Сила удара у одбојник	H_B	-	-	-	-	-	-	-	-	φ_7	-
Сила удара склопа за подизање	H_{TA}	-	-	-	-	-	-	-	-	-	1

* η – дио терета који се диже и који остаје након уклањања корисног терета, а који није урачунат у сопствену тежину крана.

Приликом анализирања вертикалног оптерећења на кранске носаче, разматрају се различити положаји мачке (колица) на крану, као и различит положај крана на кранском носачу, како би се добили мјеродавни утицаји на носачу. Прорачуни се врше за комбинације са корисним теретом и без терета, узимајући у обзир и могуће ексцентрично дејство вертикалног оптерећења. Препорука је да се ексцентричност узме као 25% од ширине главе шине [1]. Прописима [1] су у поглављу 2.5.2.1. дефинисани мјеродавни положаји оптерећења како је приказано на Сликама 1. и 2.

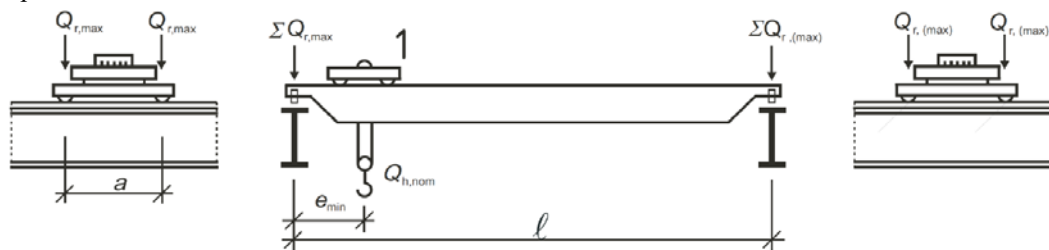

Слика 1 Приказ положаја оптерећења од крана за одређивање максималног утицаја на носачу [1]

Максимална реакција на носач од вертикалног оптерећења $Q_{r,max}$ одређује се тако што се кран оптерећен максималним теретом $Q_{h,nom}$ постави у најближи могући положај посматраној кранској стази e_{min} . Овако одређен утицај $Q_{r,max}$ потребно је подужно на носачу крана посматрати као покретно оптерећење како би се добила анвелопа мјеродавних максималних утицаја за његово димензионисање у зависности од статичког система кранског носача.

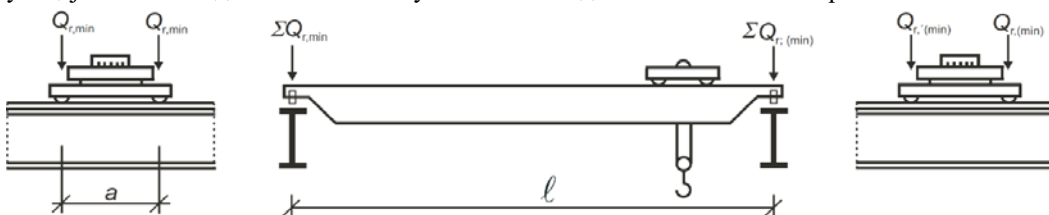

Слика 2. Приказ положаја оптерећења од крана за одређивање минималног утицаја на носачу [1]

Минимална реакција на носач од вертикалног оптерећења $Q_{r,\min}$ одређује се тако што се кран без терета постави у најудаљенији могући положај од посматране кранске стазе. Овако одређен утицај $Q_{r,\min}$ потребно је подужно на носачу крана такође посматрати као покретно оптерећење како би се добила анвелопа мјеродавних минималних утицаја за његово димензионисање.

Вриједности динамичких коефицијената за вертикална оптерећења ($\varphi_1, \varphi_2, \varphi_3, \varphi_4$) дате су у [1] у табели 2.4. у зависности од карактеристика крана и терета, типа и класе уређаја за подизање терета, те толеранције шина по којима се кран креће.

Хоризонтална оптерећења која треба узети у обзир су:

- хоризонталне силе које настају због убрзавања и успоравања кретања кранског моста,
- хоризонталне силе које настају због убрзавања и успоравања кретања „мачке“ (колица) по кранском мосту,
- хоризонталне силе које настају због закошења при кретању кранског моста,
- ударне силе у бранике због кретања крана,
- ударне силе због кретања „мачке“ (колица).

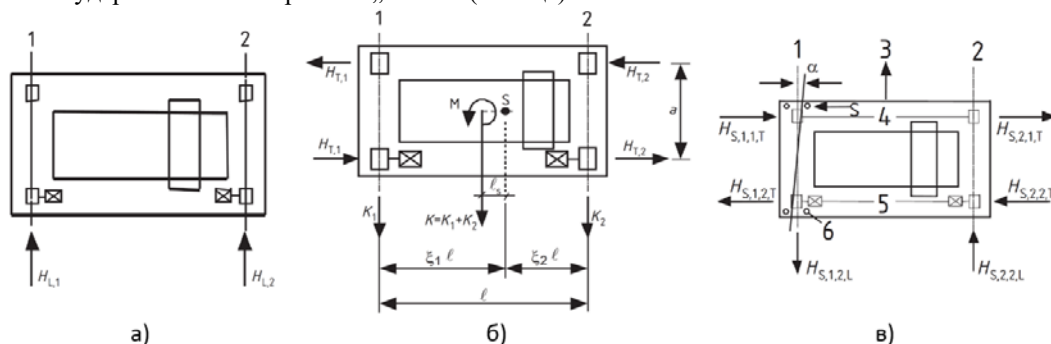

Слика 3. Хоризонтална оптерећења од крана: а) подужне хоризонталне силе; б) попречне хоризонталне силе усљед убрзања и кочења; в) подужне и попречне силе усљед закошења крана [1]

Подужне хоризонталне силе се израчунавају из израза:

$$H_{L,i} = \varphi_5 K \frac{1}{nr} \quad (2)$$

гдје је:

K погонска сила,

φ_5 динамички коефицијент,

nr број носача кранске стазе (број шина).

Попречне силе усљед убрзања и кочења крана приказане на Слици 3.б) рачунају се према изразима (3-9):

$$H_{T,1} = \varphi_5 \xi_2 \frac{M}{a} \quad (3)$$

$$H_{T,2} = \varphi_5 \xi_1 \frac{M}{a} \quad (4)$$

$$\Sigma Q_r = \Sigma Q_{r,\max} + \Sigma Q_{r,(max)} \quad (5)$$

$$\xi_1 = \frac{\Sigma Q_{r,\max}}{\Sigma Q_r} \quad (6)$$

$$\xi_2 = 1 - \xi_1 \quad (7)$$

$$M = K l_s \quad (8)$$

$$l_s = (\xi_1 - 0.5) l \quad (9)$$

Уколико погонска сила K није дефинисана од стране произвођача крана потребно је усвојити према [1], члан 2.7.3.

Вриједност динамичког коефицијента φ_5 такође дефинише произвођач крана, у супротном потребно га је усвојити из [1], члан 2.7.2. према табели 2.6.

Попречне и подужне силе које настају као посљедица закошења крана приказане на Слици 3.в) одређују се према изразима (10-13):

$$H_{S,1,j,L} = f \lambda_{S,1,j,L} \Sigma Q_r \quad (10)$$

$$H_{S,2,j,L} = f \lambda_{S,2,j,L} \Sigma Q_r \quad (11)$$

$$H_{S,1,j,T} = f \lambda_{S,1,j,T} \Sigma Q_r \quad (12)$$

$$H_{S,2,j,T} = f \lambda_{S,2,j,T} \Sigma Q_r \quad (13)$$

гдје је:

i редни број шине,

j одговарајући пар точкова,

f фактор који зависи од мјеродавног угла закошења α , $f = 0.3 (1 - \exp(-250 \alpha)) \leq 0.3$, α угао закошења дефинисан у [1], члан 2.7.4. Слика 2.8, $\lambda_{S,i,j,k}$ фактор силе.

Оптерећење које настаје приликом удара крана у одбојник може се одредити према изразу :

$$H_{B,1} = \varphi_7 v_1 \sqrt{m_c S_b} \quad (14)$$

гдје:

v_1 (m/s) представља 70% максималне брзине кретања крана,

m_c (kg) маса крана или терета који се диже,

S_b (N/m) еластична крутост одбојника,

φ_7 динамички коефицијент који је дефинисан у [1], члан 2.11. Табела 2.10.

2.2. ПРОРАЧУНСКЕ КОМБИНАЦИЈЕ

Димензионисање носача према Еврокоду подразумева прорачуне према граничним стањима носивости (ULS) и граничним стањима употребљивости (SLS). Контрола граничних стања носивости подразумева провјеру носивости карактеристичних попречних пресека кранског носача, провјеру локалних напрезања од притиска точка, контролу интеракције локалних и глобалних напрезања носача, провјеру стабилности носача која подразумева носивост носача на бочно торзионо извијање и носивост на избочавање ребра, као и контролу замора материјала. [5]

Приликом прорачуна претходно анализирана оптерећења од крана комбинују се са осталим оптерећењима на кранским стазама као што су температурни утицаји, ревизионе стазе и платформе, изузетна оптерећења, друга корисна и стална оптерећења која дјелују на носач. Ова оптерећења комбинују се према изразу (15) и (16) множењем са одговарајућим парцијалним коефицијентима за оптерећења дефинисаним у [3]. За сталне и пролазне прорачунске ситуације:

$$\Sigma \gamma_{G,i} G_{k,i} + \gamma_P P + \gamma_{Q,1} Q_{k,1} + \Sigma \gamma_{Q,i} \psi_{0,i} Q_{k,i} \quad (15)$$

За инцидентне прорачунске ситуације:

$$\Sigma G_{k,j} + P + A_d + (\psi_{1,1} \text{ или } \psi_{2,1}) Q_{k,1} + \Sigma \psi_{2,i} Q_{k,i} \quad (16)$$

Вриједности парцијалних коефицијената дате су у Табели 3.

Табела 3. Парцијални коефицијенти сигурности према Еврокоду [3]

Дејства	Симбол	Прорачунске ситуације	
		Сталне и пролазне	Инцидентне
Стална дејства од крана			
неповољна	$\gamma_{G,sup}$	1.35	1.00
повољна	$\gamma_{G,inf}$	1.00	1.00
Промјенљива дејства од крана			
неповољна	$\gamma_{Q,sup}$	1.35	1.00
повољна	$\gamma_{Q,inf}$	1.00 (0.00)	1.00 (0.00)
Остала корисна оптерећења			
неповољна	γ_Q	1.50	1.00
повољна	γ_Q	0.00	0.00
Инцидентна дејства			
Инцидентна дејства	γ_A		1.00

Вриједност коефицијената ψ_i узима се према [3], и износе $\psi_0=1.0$, $\psi_1=0.9$, док се ψ_2 израчунава као однос сталног и укупног оптерећења од крана.

Контрола челичних носача кранских стаза врши се према [2], а поред глобалних провјера подразумијева и претходно наведене локалне контроле напона и стабилности. Контрола локалних напона од притиска точка подразумијева контролу нормалних и смичућих напона, а зависи од ширине шине и фланше, као и начина на који је остварена веза између шине и носача. Приликом контроле избочавања ребра кранског носача потребно је извршити провјеру за дејство нормалних напона притиска код класе пресјека 4, смичућих напона, локалног притиска точка, а за случај дејства трансверзалне силе на притиснутој ножици и провјеру интеракције нормалних напона са смичућим односно са локалним притиском. Контрола замора кранских носача такође је дефинисана у [1], израчунава се према изразу (17) и зависи од динамичког коефицијента $\varphi_{fat} = \frac{1+\varphi_2}{2}$, максималног притиска точка крана $Q_{max,i}$ и фактора динамичког оптерећења λ_i који зависи од класе крана.

$$Q_e = \varphi_{fat} \lambda_i Q_{max,i} \quad (17)$$

Провјере за гранична стања употребљивости прописују:

- контролу вертикалних помјерања - угиба кранских носача,
- контролу хоризонталних помјерања - хоризонтални угиби, размицања шина, помјерања стубова (рамова) у нивоу шине крана,
- контролу напона – повратно еластично понашање носача за комбинације оптерећења за контролу употребљивости,
- „web breathing“ контрола ребра носача,
- контрола вибрација ножице кранског носача.

Према [3] за прорачун граничних стања употребљивости, изостављају се сви парцијални коефицијенти сигурности, и анализа се спроводи за комбинације утицаја дефинисане у Табели 4.

Табела 4. Мјеродавне комбинације утицаја за SLS прорачуне

Комбинација	Стална дејства		Корисна дејства	
	неповољна	повољна	неповољна	повољна
Карактеристична	$G_{kj,sup}$	$G_{kj,inf}$	$Q_{k,1}$	$\Psi_{0,i} Q_{k,i}$
Честа	$G_{kj,sup}$	$G_{kj,inf}$	$\Psi_{1,1} Q_{k,1}$	$\Psi_{2,i} Q_{k,i}$
Квази-стална	$G_{kj,sup}$	$G_{kj,inf}$	$\Psi_{2,1} Q_{k,1}$	$\Psi_{2,i} Q_{k,i}$

Граничне вриједности угиба дефинисане су у [2], Дио 6 – Табела 7.1, и одређују допуштене вертикалне угибе кранског носача, разлику вертикалних помјерања лијевог и десног кранског носача, хоризонтални угиб кранског носача, размицање носача кранских стаза, хоризонтално помјерање стуба (рама) у висини горње ивице шине крана као и разлику хоризонталних помјерања односно закошење сусједних рамова или стубова у раму у нивоу ГИШ.

Провјера напона подразумијева еластично понашање при употребном оптерећењу кроз контролу нормалних, смичућих и упоредних напона. Контрола вибрација и „web breathing“ обавезно се провјеравају за ребра велике висине и виткости, а прописима се ограничава виткост доње ножице кранског носача на $\lambda \leq 250$ како би се избјегао проблем вибрација.

3. НУМЕРИЧКИ ПРИМЈЕР НОСАЧА КРАНСКЕ СТАЗЕ

3.1. АНАЛИЗА ОПТЕРЕЋЕЊА И УСВАЈАЊЕ ДИМЕНЗИЈА КРАНског НОСАЧА

За потребе монтаже/демонтаже и ремонта машинске опреме у машинској згради хидроелектране инсталиран је кран носивости 25t, димензија и карактеристика према спецификацији произвођача на Сликама 4 и 5.

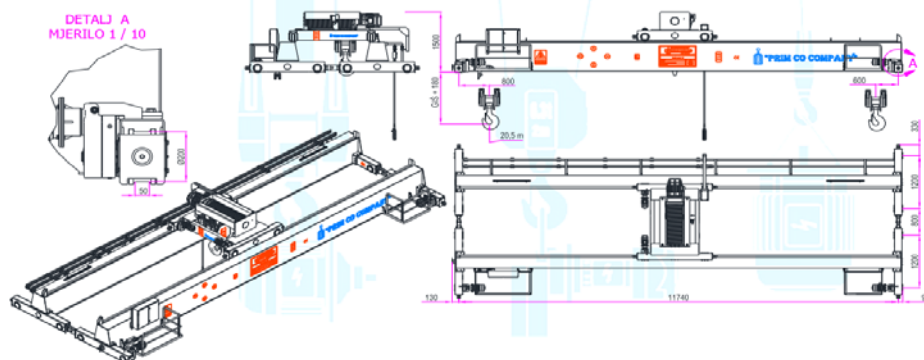
1. PREDMET : Dvogredna električna mosna dizalica DMD 25 t x 11,74 m

Слика 4. Изглед мосног крана носивости 25t (PRIM CO Company)

Opis kрана	DMD 25 t x 11,74 m		
Sopstvena težina kрана	$Q_{c1} =$	62	kN
Sopstvena težina kolica	$Q_{c2} =$	75.6	kN
Opterećenje dizalice	$Q_{h,nom} =$	250	kN
Raspon kрана	$L_c =$	11.74	m
Visina dizanja	$h =$	20.5	m
Brzina kretanja kрана	$v_{cn} =$	0÷25	m/min
Brzina kretanja kolica	$v_{cn} =$	0÷15	m/min
Brzina potizanja	$v_{cn} =$	0.6÷2.5	m/min
Dimenzija šine	$b/h =$	50/50	mm
Broj osa	$n_a =$	4	kom
Razmak osa 1	$a_1 =$	1.2	m
Razmak osa 2	$a_2 =$	0.8	m
Razmak osa 3	$a_3 =$	1.2	m
Dužina odbojnika nosača kрана	$a_L = a_R =$	0.33	m
Dužina odbojnika kрана	$b_L = b_R =$	0	m
Minimalni ekscentricitet kolica	$e_{min} =$	0.8	m
Veza šina - nosač	<i>kruta</i>		
Klasa podizanja	<i>HC1</i>		
S klasa (klasa zamora)	<i>S2</i>		

Слика 5. Основни технички подаци за мосни кран носивости 25t (PRIM CO Company)

Као што се види из проспекта произвођача у питању је двогредна мосна дизалица са колицима, распона 11.74 m, висине дизања 20.50 m. Осим геометријско машинских карактеристика крана, на основу намјене и предвиђене употребе крана одређени су и остали параметри неопходни за прорачун као што су класа дизања, класа замора, те изабран тип везе шине за крански носач. Према датим подацима одређени су динамички коефицијенти приказани у Табели 5.

 Табела 5. Вриједност динамичких коефицијената φ_i

Дејство	Ознака динамичког коефицијента	Вриједност коефицијента	Референца EN 1991-3; EN 1993-6
Тежина крана	φ_1	1.1	чл. 2.6 Табела 2.4
Терет	φ_2	1.06	чл. 2.6 Табела 2.4 и Табела 2.5
Нагло отпуштање терета	φ_3	1	чл. 2.6 Табела 2.4

Кретање крана	φ_4	1	чл. 2.6 Табела 2.4
Сила покретања	φ_5	1.5	чл. 2.7.2 Табела 2.6
Сила удара у пригушивач	φ_7	1.25	чл. 2.11.1 Табела 2.10

Прорачунске вриједности улазних оптерећења од крана разврстане су према прописима на хоризонталне и вертикалне, како је то претходно описано и износе:

Вертикална оптерећења:

$$\begin{aligned} \sum Q_{c,min} &= \frac{1}{2} Q_{c1} + Q_{c2} \frac{e_{min}}{L_c} = 36.21 \text{ kN} \Rightarrow Q_{c,min} = \frac{\sum Q_{c,min}}{n} = 9.05 \text{ kN} \\ \sum Q_{c,max} &= \frac{1}{2} Q_{c1} + Q_{c2} (1 - \frac{e_{min}}{L_c}) = 102.29 \text{ kN} \Rightarrow Q_{c,max} = \frac{\sum Q_{c,max}}{n} = 25.57 \text{ kN} \\ \sum Q_{h,min} &= Q_{h,nom} \frac{e_{min}}{L_c} = 17.04 \text{ kN} \Rightarrow Q_{h,min} = \frac{\sum Q_{h,min}}{n} = 4.26 \text{ kN} \\ \sum Q_{h,max} &= Q_{h,nom} (1 - \frac{e_{min}}{L_c}) = 232.96 \text{ kN} \Rightarrow Q_{h,max} = \frac{\sum Q_{h,max}}{n} = 58.24 \text{ kN} \end{aligned}$$

Хоризонтална оптерећења:

$$\begin{aligned} H_{L1} = H_{L2} &= \frac{K}{n_r} = 1.81 \text{ kN} \quad H_{T1} = \xi_2 \frac{M}{a} = 0.66 \text{ kN} \quad H_{T2} = \xi_1 \frac{M}{a} = 4.16 \text{ kN} \\ H_{S,1,0,T} &= f \lambda_{S,1,0,T} \sum Q_r = 3.03 \text{ kN} \quad H_{S,2,0,T} = f \lambda_{S,2,0,T} \sum Q_r = 19.08 \text{ kN} \\ H_{S,1,1,T} &= f \lambda_{S,1,1,T} \sum Q_r = 1.55 \text{ kN} \quad H_{S,2,1,T} = f \lambda_{S,2,1,T} \sum Q_r = 9.73 \text{ kN} \\ H_{S,1,2,T} &= f \lambda_{S,1,2,T} \sum Q_r = 0.56 \text{ kN} \quad H_{S,2,2,T} = f \lambda_{S,2,2,T} \sum Q_r = 3.50 \text{ kN} \\ H_{S,1,3,T} &= f \lambda_{S,1,3,T} \sum Q_r = -0.93 \text{ kN} \quad H_{S,2,3,T} = f \lambda_{S,2,3,T} \sum Q_r = -5.84 \text{ kN} \end{aligned}$$

За срачуната оптерећења извршено је димензионасање носача кранске стазе према граничним стањима носивости и употребљивости. Крански носач је статичког система континуалне греде, распона $l_1=l_2=8.12 \text{ m}$ и $l_3=2.65 \text{ m}$. Висина усвојеног кранског носача је 600 mm , дебљина ребра је 10 mm , ширина горње ножице 380 mm , дебљина 30 mm , док је ширина доње ножице 300 mm , а дебљина 20 mm . Вертикална укрућења ребра су предвиђена како би се обезбиједила стабилност на избочавање и бочно торзионо извијање, постављају се приближно на сваких 160 cm .

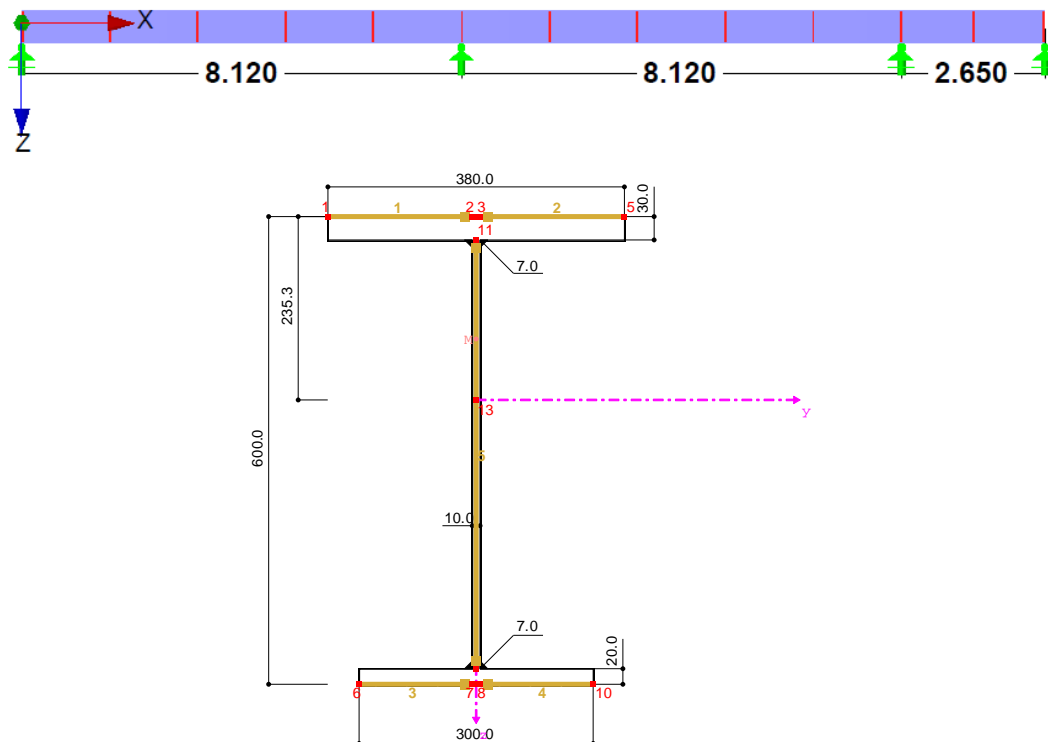

Слика 6. Геометријске карактеристике носача кранске стазе (приказ из софтвера CRANEWAY за прорачун)

3.2. ПРИКАЗ РЕЗУЛТАТА ДИМЕНЗИОНИСАЊА

Водећи рачуна о обимности, у овом раду неће бити дат детаљан поступак прорачуна, већ само најзначајнији резултати анализе носивости и употребљивости кранског носача, али је увид у процедуру и детаље димензионисања могуће остварити контактирајући ауторе. Спроведени прорачун носача кранске стазе за гранично стање носивости састоји се од:

- класификације попречног пресека,
- доказа носивости ребра носача на трансверзалне силе,
- доказа носивости горње ножице на смицање,
- доказа носивости на комбиновани утицај смицања и торзије носача,
- доказа носивости на бочно савијање због закошења крана при кретању уз подужну силу,
- доказа носивости на бочно торзионо извијање,
- доказа носивости ребра услед концентрисане силе притиска точка,
- доказа носивости шавова на споју ребра са ножицама носача.

Доказ носивости носача кранске стазе за гранично стање употребљивости састоји се од:

- прорачуна угиба од вертикалног оптерећења,
- прорачуна угиба од хоризонталног оптерећења,

Остале контроле прописане Еврокодом као што су размицање носача кранских стаза и отклони услед помјерања стубова (рамова) у висини шине прорачунате су на другом, просторном моделу машинске зграде.

Контрола замора састоји се од:

- прорачуна еквивалентног оптерећења за класу замора C2,
- поступка прорачуна замора између ребра и горње ножице за нормалне и смичуће напоне, те за интеракцију тих напрезања.

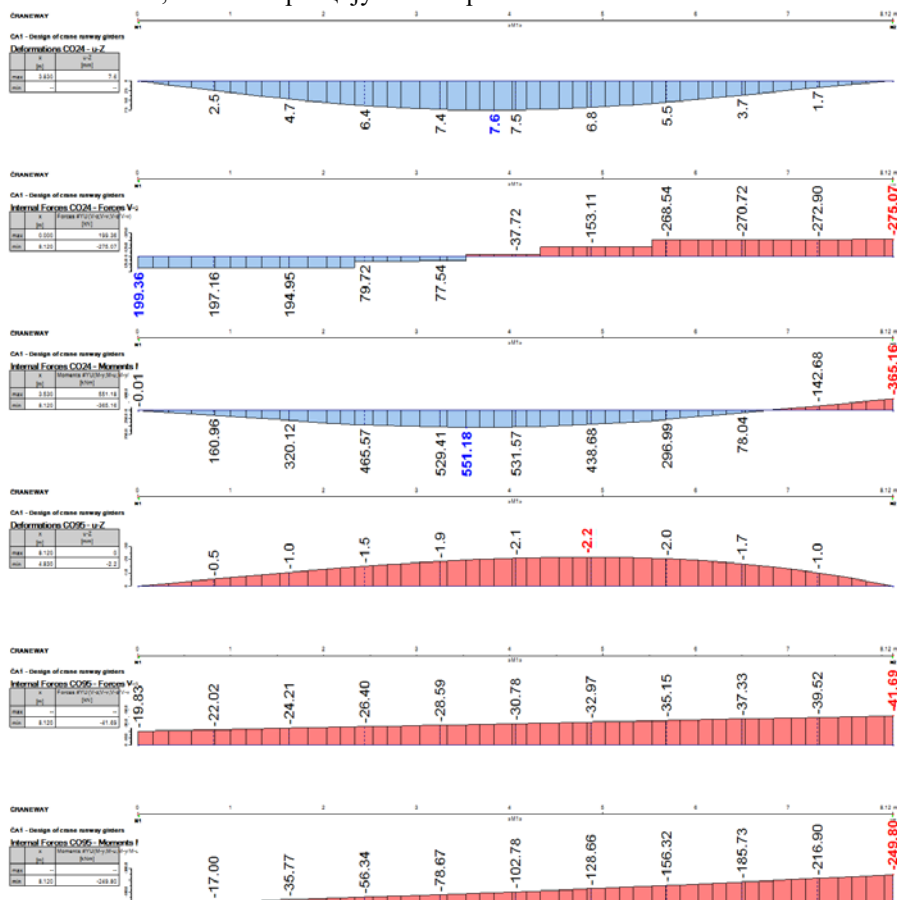

Слика 7. Пресјечне силе и угиби на носачу за мјерадавне комбинације оптерећења у мјерадавом распону носача

Формирањем одговарајућих прорачунских комбинација у складу са прописима, добијени су мјеродавни утицаји за димензионисање носача. На Слици 7. приказане су вриједности угиба, трансверзалних сила и момената, за доњу и горњу зону, респективно. Прорачунски угиби се крећу између вриједности од 7.6 mm и -2.2 mm, зависно од положаја оптерећења дуж континуалног носача крана. Ови угиби су у границама максимално допуштених помјерања према Еврокоду. Максимални моменат у доњој зони носача је 551.18 kNm, док је у горњој зони 365.16 kNm. Трансверзална сила у носачу у правцу Z осе кретала се у интервалу од 200.0 kN до -275.07 kN. Дејства у хоризонталном правцу која су углавном посљедица хоризонталних оптерећења краном су знатно мања, а изазивају хоризонталне угибе до максимално 4.6 mm. Суперпонирањем хоризонталних утицаја од торзије, смичуће силе и савијања добијене су и деформације ротације пресека у износу од 24.1 mrad, док су од вертикалних оптерећења -10.0 mrad. Приказани утицаји на носачу кранске стазе изазивају различита напрезања, која су у границама допуштених за изабрану геометрију носача, а што је приказано на сликама 8, 9 и 10 на подужном приказу носача, односно на слици 11. у приказу мјеродавног попречног пресека за напрезања и деформације.

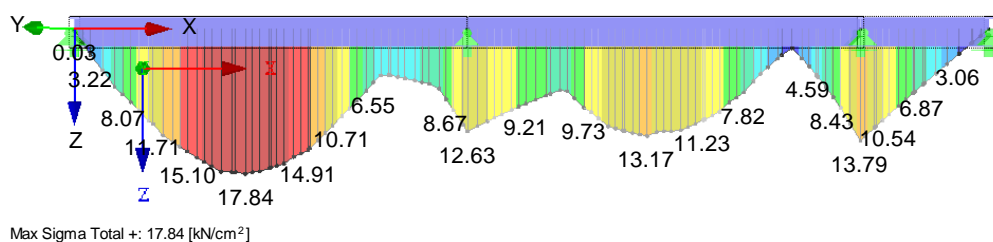

Слика 8. Приказ максималних нормалних напрезања дуж носача

На слици 8. приказани су нормални напони у носачу. Наведени утицаји представљају анвелопу напона за мјеродавне комбинације оптерећења према Еврокоду, статичка и покретна оптерећења, умножена одговарајућим факторима. Максималан нормални напон износи $\sigma_x = 17.84 \text{ kN/cm}^2$.

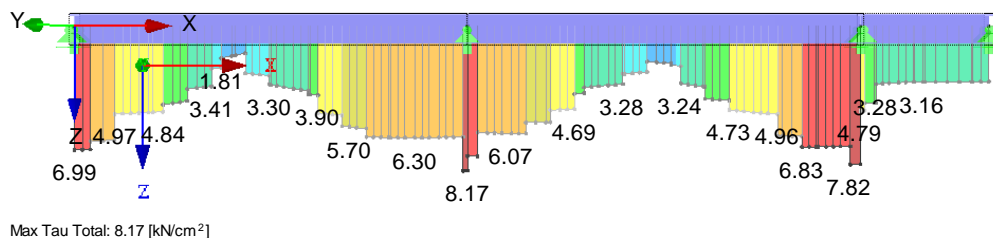

Слика 9. Приказ максималних смичућих напрезања дуж носача

На слици 9. приказани су максимални смичући напони у носачу за анвелопу утицаја. Максималан смичући напон износи $\tau_t = 8.17 \text{ kN/cm}^2$.

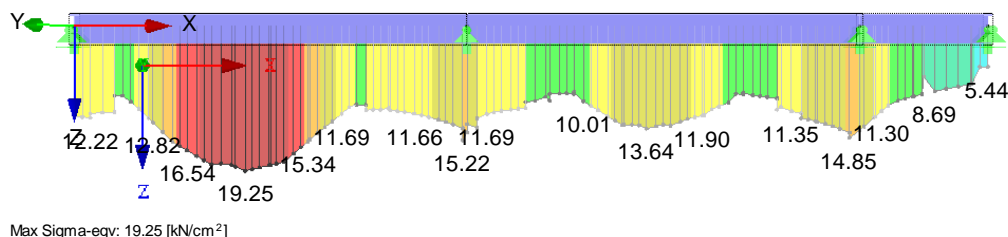

Слика 10. Приказ упоредног напона за носач кранске стазе

На слици 10. дат је упоредни напон са максималном вриједношћу од $\sigma_{eqv} = 19.25 \text{ kN/cm}^2$. Искоришћење носача на мјесту максималног напрезања износи приближно 86% у односу на допуштену носивост за дату класу пресека.

Осим напонских провјера, испоштована је и стабилност носача на локална избочавања, као и бочна торзиона извијања, те су усвојена укрућења ребра кранског носача. Такође извршена је и контрола вибрација у складу са прописима, те контрола замора материјала. Провјером на замор материјала добијени су коефицијенти $\eta_{\Delta\sigma_x} = 0.36 < 1$ и $\eta_{\Delta\sigma_{E2}} = 0.51 < 1$. Контролом стабилности на избочавање и извијање носача добијен је максимални коефицијент $\eta_{init} = 0.52 < 1$ за интеракцију нормалне силе, момената савијања и смичуће силе, што задовољава

прописане захтјеве. Појединачни коефицијенти отпорности пресјека за раздвојена напонска стања, те отпорност ребра и ножица носача су такође задовољавајућа и са мањим степеном искоришћења у односу на приказани коефицијент. Такође, извршена је и провјера носивости и замора шавова с обзиром на то да је носач формиран заваривањем, као и крута веза шине за горњу ножицу носача. Носивост шавова је задовољена за све прорачунске комбинације, са максималним коефицијентом искоришћења шавова од $\eta_{\text{weld}}=0.61 < 1$.

Важно је напоменути да се приликом прорачуна односно моделирања носача правилно усвоји и тип везе кранског носача са остатком конструкције. За конкретан носач усвојене су зглобне везе кранског носача које се формирају вијцима за кратки елемент на армирано бетонским стубовима. Осим тога, у циљу смањења утицаја од температуре и других паразитних дејстава потребно је правилно конструисати ове везе или уобзирити дата оптерећења у складу са прописима.

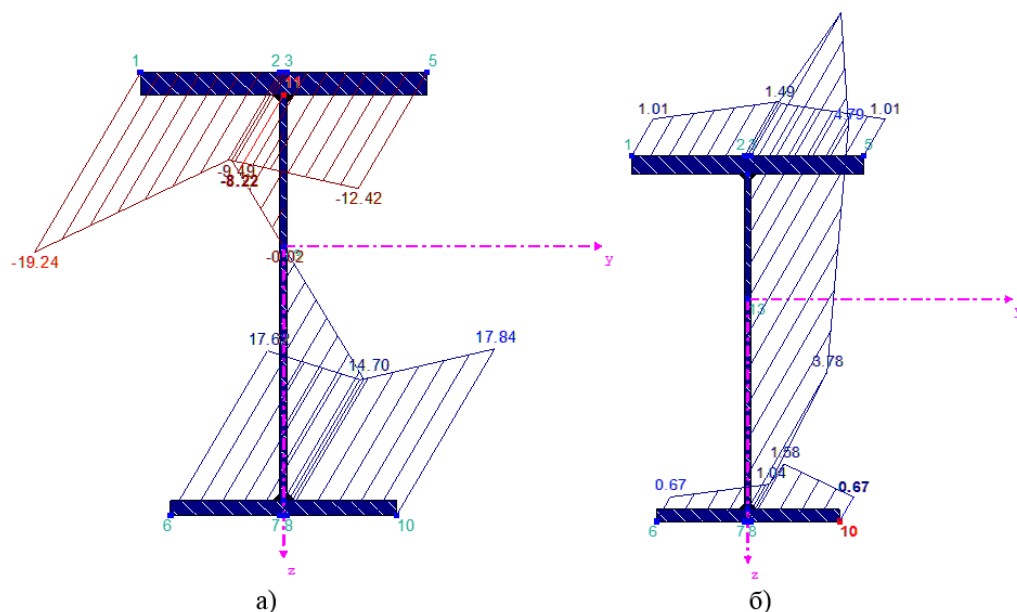

Слика 11. Приказ а) нормалног и б) смичућег напона у попречном пресеку кранског носача

На слици 11. дата су напрезања за карактеристични пресјек кранског носача, односно расподјела напона у ножицама и ребру попречног пресека. На слици а) приказан је максимални нормални напон који износи $\sigma_{\text{eqv}}= 19.25 \text{ kN/cm}^2$ за пресјек на дужини $x=3.53\text{m}$ од почетка носача и њему одговарајући смичући напони б). Максимални смичући напон је у пресеку на дужини $x=8.12 \text{ m}$ и износи $\tau_t= 8.17 \text{ kN/cm}^2$.

4. ЗАКЉУЧАК

Различити типови кранова имају широку примјену у индустријским објектима за транспорт свих врста терета. Нови европски прописи који су у процесу усвајања и у нашој земљи доносе бројне новине у димензионисању носача кранских стаза. Процедура и примјер предочен у овом раду, скупа са специфичним случајевима који због обимности рада нису обухваћени а прописани су према [1] и [2], показују сложеност и обимност димензионисања носача кранских стаза према Европским нормама у односу на до сада важећи правилник за прорачун ове врсте челичних конструкција. Детаљност овог прорачуна оставља мање простора за грешку и евентуалне пропусте пројектанта, али захтијева већи ниво експертизе и инжењерског знања. Олакшавајућу околност представља чињеница да већина комерцијалних софтвера предвиђена за димензионисање челичних конструкција у себи већ садржи уграђене прописе, са свим потребним коефицијентима и процедуром прорачуна, те се највећи задатак пројектанта своди на правилну израду анализе и задавања оптерећења, те израду модела носача са одговарајућим граничним условима, укрућењима и сл.

Према тренутно важећим прописима за прорачун челичних носача према теорији допуштених напона, поред разлика у прорачунском приступу за гранична стања носивости и употребљивости постоји доста дилема за пројектанте приликом усвајања појединих коефицијената уколико нису дефинисани од стране произвођача опреме, а који се усвајају на

основу искуства и субјектвне процјене, док Еврокод нормe дефинишу препоручене прорачунске вриједности у таквим случајевима.

ЛИТЕРАТУРА

- [1] Eurocode 1991 – Actions on structures - Part 3: Actions induced by cranes and machinery, European committee for standardization-CEN, July 2006
- [2] Eurocode 1993 – Design of steel structures - Part 6: Crane supporting structures, European committee for standardization-CEN, April 2007
- [3] Eurocode 1990 – Basis of structural design, European committee for standardization-CEN, December 2005
- [4] З. Марковић, „Гранична стања челичних конструкција према Еврокоду“, Академска мисао, Грађевински факултет Универзитета у Београду, Београд, 2014
- [5] Д. Маркулак, „Прорачун кранских носача према Еурокод нормама“, Електронички часопис Грађевинског факултета Осигек, мај 2011



Dragan Nikolić, Visoka građevinsko-geodetska škola, Beograd, nikolic@vggs.rs

Dragan Bojović, Institut IMS, dragan.bojovic@institutims.rs

Goran Ćirović, University of Belgrade, cirovic@sezampro.rs

USING AND MODELING GROUND PENETRATING RADAR ON DENSELY REINFORCED SLABS

Abstract

Ground Penetrating Radar - GPR by modern equipment has grown in importance in recent years in non-destructive testing. Estimating steel rebar position and diameter is the main focus for assessment of existing reinforcement concrete facilities. This paper presents the latest modern non-destructive technique – suitable for testing reinforcement concrete members. The capabilities of this technique for locating reinforcement bars in unilaterally accessible, densely reinforcement slab are described.

Keywords: Densely reinforcement slab, ground penetrating radar, stepped-frequency wave GPR

ПРИМЕНА И МОДЕЛИРАЊЕ ГЕОРАДАРА НА ГУСТО АРМИРАНИМ ПЛОЧАМА

Сажетак

Испитивање бетона георадаром у последњих неколико година је добило на значају у односу на примену осталих метода без разарања. Мерење положаја и пречника шипки су основни фактори за процену стања постојећих армиранобетонских објеката. У раду је приказана примена ове неструктивне методе са модерном опремом за испитивање армиранобетонских елемената. Приказане су могућности лоцирања положаја шипки арматуре на густо армираним плочама чија је само једна страна доступна за испитивање.

Кључне ријечи: Густо армиране плоче, георадар, stepped-frequency continuous wave GPR

1. INTRODUCTION

Ground penetrating radar (GPR) is a non-destructive technique with a wide range of potential applications in the testing of concrete structure. Large part of domestic industrial facilities and infrastructure was built between 1960–1980. The most of them have unknown rebar spacing, cover and diameter due to the non-availability of their structural drawings. Information on rebar diameter, spacing and cover depth is essential in determining the structural capacity. It is gaining acceptance as a useful and rapid technique for non-destructive detection of inhomogeneities and the types of other defects, which can occur in reinforced concrete elements. When evaluating structural integrity or carrying out retrofits in concrete structures, it is also important that you detect embedded objects. The operating principle of GPR is based on detecting discontinuities of dielectric properties that are caused by one or more targets at different depths and orientations within the object under investigation. At the boundaries of such discontinuities, electromagnetic energy is partially transmitted through the targets and partially reflected in various directions, among which also towards the surface of the object [1].

Most GPR consist of three components: a console, an antenna, and an encoder. The first two are mandatory. The console is the brains of the system. This data logger communicates with both the encoder and the antenna to initiate a signal and record the responses. The antenna is where the GPR signal is produced.

The main advantages of GPR are: its fast data acquisition capability, its high resolving ability and the fact that it responds equally well to metallic and nonmetallic targets. Its main drawback is the complex nature of its data and the difficulty that the GPR user faces when trying to interpret them. Interpretation of the data acquired using a GPR is often a complicated and error-prone procedure, mainly due to the complexity of the GPR signals and the variety of factors that influence and determine them [2].

The dielectric properties of the object determine the speed of the electromagnetic waves within it. This enables the user to estimate the absolute depth of the reflecting targets. Precise speed estimation depends on knowledge of tabulated values of dielectric properties, such as those of wet or dry concrete.

Estimated depths and locations are then graphically represented in 2D or 3D views. Further physical effects within the object itself, its embedded targets and their interfaces, such as attenuation, scattering, and losses, affect the signal strength adversely. The strength of some of these unwanted effects depends on the frequency of the transmitted electromagnetic wave.

2. PHYSICAL PRINCIPLES AND THEORY

GPR principles are based on the electromagnetic (EM) theory where the physics of the EM field propagation is described by Maxwell's equations and material properties are quantified by constitutive equations. As a combination of these two factors, the GPR signal is an output that provides information about the properties and configuration of the subsurface [3].

The propagation of the EM waves depends on the three main EM properties of the host material: the dielectric permittivity ϵ , the electric conductivity σ and the magnetic permeability μ . The dielectric permittivity and the electric conductivity are strictly related to the EM wave features. ϵ affects the wave velocity, and σ controls the wave attenuation. On the contrary, the magnetic permeability μ does not relate to the propagation of the wave for all the non-magnetic materials, as it is equal to the free-space magnetic permeability μ_0 . On the other hand, the main factors affecting the penetration depth are the frequency of the emitted signal (for structural inspections, antennas with central frequencies above 1 GHz are used) and the type of material investigated [3,4].

Theoretical background of EM fields is described by Maxwell's equations as follows:

$$\nabla \times E = -\frac{\partial B}{\partial t} \quad (1)$$

$$\nabla \times H = J + \frac{\partial D}{\partial t} \quad (2)$$

$$\nabla \cdot D = q \quad (3)$$

$$\nabla \cdot B = 0 \quad (4)$$

where E is the strength vector of the electric field ($V m^{-1}$); q the electric charge density ($C m^{-3}$); B is the density vector of the magnetic flux (T); J is the density vector of the electric current ($A m^{-2}$); D is the electric displacement vector ($C m^{-2}$); t is the time (s); and H is the intensity vector of the magnetic field ($A m^{-1}$).

Material properties are instead quantified by the following constitutive relationships:

$$J = \sigma \cdot E \quad (5)$$

$$D = \varepsilon \cdot E \quad (6)$$

$$B = \mu \cdot H \quad (7)$$

Combination of the EM fields' theory and the material properties allows to describe comprehensively a GPR signal.

The speed of propagation of electromagnetic waves in a different environment is:

$$v = \frac{1}{\sqrt{\varepsilon_0 \cdot \varepsilon_r \cdot \mu_0 \cdot \mu_r}} = \frac{c}{\sqrt{\varepsilon_r \cdot \mu_r}} \quad (8)$$

For materials where the radar method is applicable, it can be assumed that $\mu_r \approx 1$ (in ferromagnetic materials this is not valid but ferromagnetic materials can not be investigated with the radar method):

$$v = \frac{c}{\sqrt{\varepsilon_r}} \quad (9)$$

This means that the signal velocity within materials is mainly defined by their relative permittivity. For practical purposes, it can be assumed that dielectric constants of materials are in the range between 1 (air) and 84 (water) which leads to signal velocities between 3×10^8 m s⁻¹(air) and 0.33×10^8 m s⁻¹(water).

The high velocity of the radar signal is responsible for one of the main advantages of the radar method. As the signals travels with such a high velocity, a single measurement takes very little time and therefore the number of measurements per second is, from a physical point of view, almost unlimited [5,6].

Reflection coefficient R is:

$$R = \frac{\sqrt{\varepsilon_1} - \sqrt{\varepsilon_2}}{\sqrt{\varepsilon_1} + \sqrt{\varepsilon_2}} \quad (10)$$

If an electromagnetic wave hits an interface, part of the energy will be transmitted and part will be reflected. For a plain electromagnetic wave in a low loss material hitting at vertical incidence an interface between two materials with ε_1 and ε_2 , the reflected wave can be described as:

reflected wave = R × incident wave

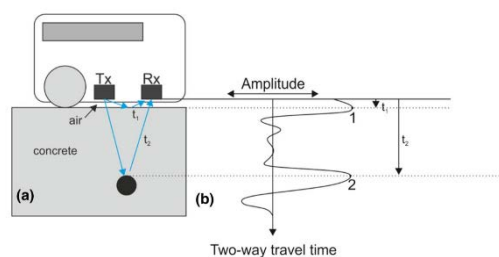

Figure 1. Layout of a survey on a reinforced concrete structure using a ground-coupled GPR system, b corresponding GPR signal output

The usual maximum penetration depth in concrete is about 60-65cm. However, it may not always achieve maximum penetration. Water in concrete is the biggest contributor to electrical conductivity. Generally, the wetter concrete has the higher its electrical conductivity, and the penetration will be worse [7].

The size of the required target affects the strength of the returning GPR wave. Larger targets that present a greater cross-section return more GPR wave energy to the receiver.

Typically, three visualisation modes can be listed for a GPR signal that provide three different levels of information: an A-scan (Figure 1), a single radar trace along the depth axis; a B-scan, a set of sequential single radar traces collected along a specific scanning direction; and a C-scan, a set of B-scans extrapolated at a certain spacing along the depth axis.

3. STEPPED-FREQUENCY CONTINUOUS WAVE GPR

Radar imaging is performed by transmitting an impulse of electromagnetic energy, which is then followed by capturing its echoes. Characteristics of an object being observed are extracted from these echoes, which contain useful information, such as range, speed, and reflectivity of the object. Instead of transmitting an impulse directly in the time domain, stepped-frequency continuous-wave (SFCW) radars synthesize the impulse in the frequency domain. Since a time, recent innovations in

the field of structural GPR now enable us to largely resolve the long-standing trade-off between resolution and penetration depth.

Proceq GPR Live uses SFCW technology, i.e. it continuously broadcasts electromagnetic waves and gathers data from the reflected component of the waves in the frequency domain. Until recently, the time-consuming calculations associated with the real-time inverse Fourier transforms in SFCW systems limited its application.

Proceq GP8800 equipment is used (Figure 2). Features the unique implementation of SFCW radar technology by Proceq, is delivering the most ultra-wide bandwidth ever in a handheld GPR device. The Proceq GPR Live app connects to the Proceq GP8800 probe and runs on any recent iPad, bringing concrete imaging to your eyes through crisp and high-resolution. Proceq GP8800 features the unique implementation of SFCW radar technology by Proceq, delivering the most ultra-wide bandwidth ever in a handheld GPR device.

Thanks to faster processing capabilities available nowadays, this limitation no longer applies to GPR. Additionally, through electronics design optimization, the maximum signal acquisition time has more than doubled compared to traditional GPR systems, as shown in the next section. Effectively, this enables a longer period during which signals can be gathered with a high signal-to-noise ratio from deeper within the object. Moreover, instead of operating using pulses centred around a single nominal frequency, it relies on multiple frequency steps with a transmitter frequency response that corresponds to the full range of modulated frequencies between 0.4 and 6.0 GHz.



Figure 2. *Proceq GPR Live 8800*

In a more realistically representative setup with the system fully coupled to a concrete structure, an ultra-wide net component between 1.0 and 3.5 GHz has been established to be practically available in the field, and immune to lower and higher frequency noise effects.

These technological features provide a distinct advantage compared to traditional GPR devices: target detection is now possible with a higher accuracy, without the need of a priori expectations of what could be detected and at which depths within the object. Additionally, the received data is processed by the onboard electronics and then visualized in 2D and 3D using a tablet.

Maximum depth range is about 65 cm in dry concrete. Measurement modes include line scan mode and area scan mode with flexible grid.

4. NUMERICAL MODELLING OF GPR

Modelling of GPR responses – either analytically or numerically – plays a central role in advancing our understanding of GPR as well as providing the means for testing new data processing techniques and interpretation software.

Most of the proposed approaches are based on the finite difference time-domain (FDTD) method. The main reasons for such widespread use of the FDTD method are: its ease of implementation in a computer programme – at least at a simple introductory level – and its good scalability when compared with other popular electromagnetic modelling methods such the finite-element and integral techniques.

The availability of a free GPR modelling tool gives both researchers and practitioners the opportunity to numerically “experiment” with GPR on their computers without incurring a substantial cost by creating expensive physical models – at least at an initial stage of a project. Simulating what-if scenarios can save money and time as well as provide data to support project proposals that could employ GPR but need some preliminary evidence in order to convince more sceptic project managers of GPR’s suitability to solve a given problem. Most importantly however,

a freely available and well documented modelling tool avoids the syndrome of re-inventing the wheel that plagues many new research efforts that need GPR modelling facilities. All electromagnetic phenomena, on a macroscopic scale, are described by the Maxwell's equations. The FDTD approach to the numerical solution of Maxwell's equations is to discretize both the space and time continua. Thus, the spatial and temporal discretization steps play a very significant role since the smaller they are the closer the FDTD model is to a real representation of the problem [8,9,10].

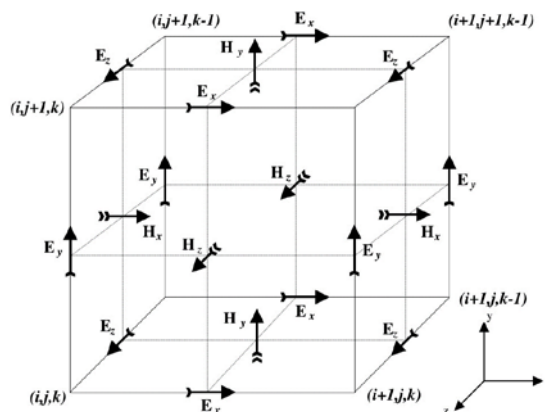

Figure 3. Yee cell.

The FDTD model represents a discretized version of the real problem and of limited size. The building block of this discretized FDTD grid is the Yee cell named after Kane Yee who pioneered the FDTD method [11]. The 3D Yee cell is illustrated in Figure 3. The 2D FDTD cell is easily obtained as a simplification of the 3D Yee cell [11].

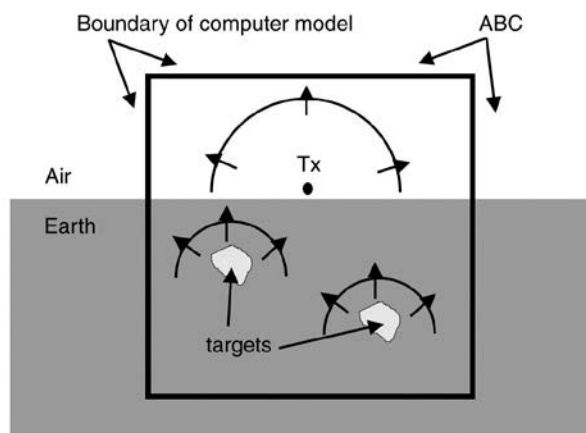

Figure 4. FDTD view of the model's space

Figure 4 illustrates the basic difference between a real problem's space and the actual FDTD modelled space. In Figure 2 it has been assumed that the half-space, where the target is situated is of infinite extent.

GprMax2D is a computer program that implements the FDTD method for GPR modelling in 2D. GprMax2D uses a simple ASCII (text) file to define the model's parameters. In this file special commands are used which instruct the software to perform specific functions that are required by the type of the model the user wants to create. Some of the commands of GprMax2D are shown in Table 1.

Table 1. Some of GprMax2D commands

Command	Function
#domain:	Controls the physical size of the model
#dx_dy:	Defines the discretization steps

#time_window:	Defines the simulated time window for the GPR trace
#medium:	Introduces the electrical properties of different media in the model
#box:	Introduce a rectangle of specific properties into the model's space
#cylinder:	Like the box: but introduces a cylinder into the model
#triangle:	Like the box: but introduces a triangular patch
#tx:	Specifies the details of a transmitter (Tx)
#rx:	Specifies the details of a receiver (Rx)
	Defines the simulated time window for the GPR trace
#scan:	Can be used to automatically generate B-Scans

The flexibility of GprMax2D allows the modelling of complex what-if scenarios. In the following a simple example of modelling rebars in concrete is presented. The geometry of the problem consists of a 2 m wide slab, where rebars of 32 mm diameter are located at an average depth of 150 mm from the slab surface. Although, the horizontal distance between each rebar is fixed at 100 mm, their cover depth is randomly varied between ± 4 mm from the average cover depth of 150 mm.

An illustration of the model's geometry is presented in Figure 5:

#title: B-scan from a steel rebars buried in a dielectric half-space (concrete)

#domain: 0.740 0.280 0.002

#dx_dy_dz: 0.002 0.002 0.002

#time_window: 5.5e-9

#material: 7 0 1 0 half_space

#waveform: ricker 1 3.5e9 my_ricker

#hertzian_dipole: z 0.200 0.240 0 my_ricker

#rx: 0.240 0.240 0

#src_steps: 0.003 0 0

#rx_steps: 0.003 0 0

#box: 0 0 0 0.740 0.240 0.002 half_space

#cylinder: 0.30 0.150 0 0.30 0.150 0.002 0.032 pec

#cylinder: 0.42 0.150 0 0.40 0.150 0.002 0.032 pec

#cylinder: 0.54 0.150 0 0.50 0.150 0.002 0.032 pec

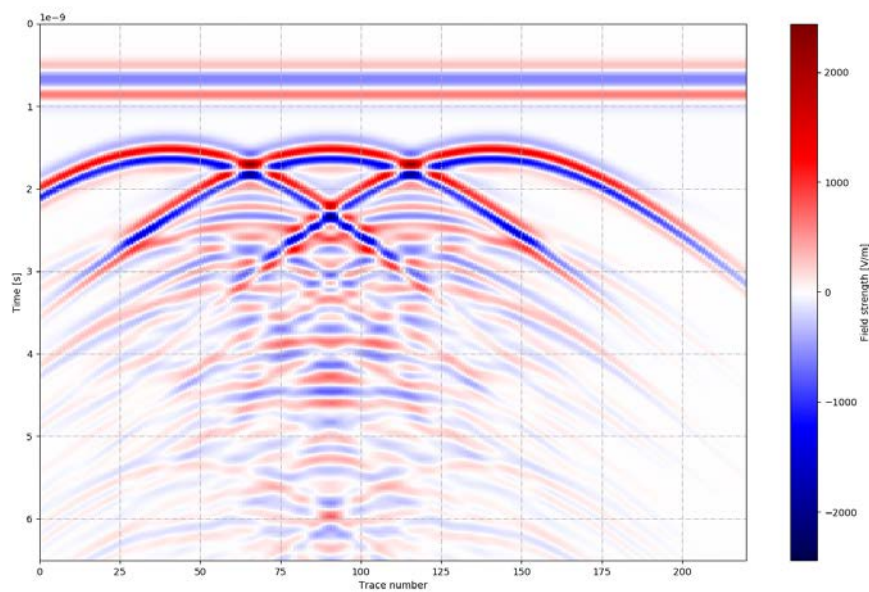

Figure 5. Simulated GPR scans from the 2D concrete slab model

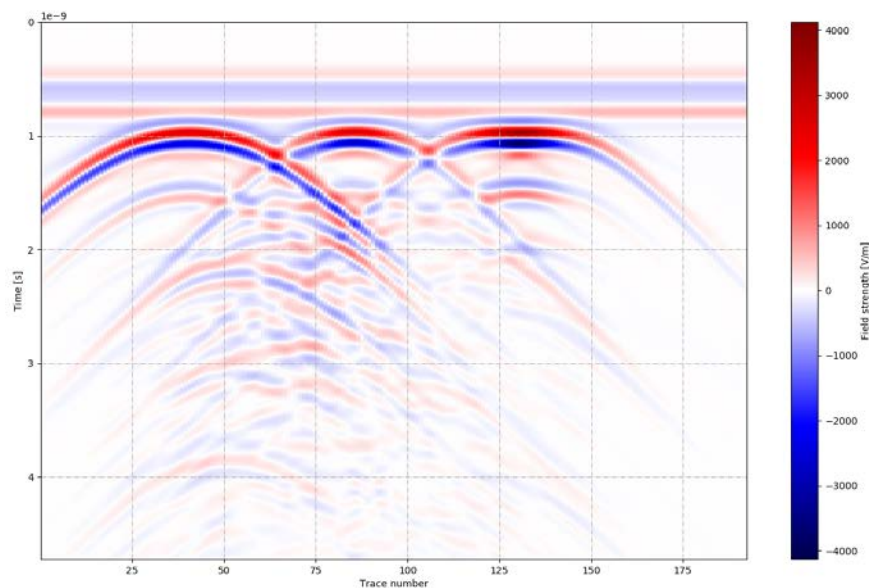

Figure 6. Simulated GPR scans with reduced cover depth

The horizontal distance between rebar remained the same and cover depth is reduced from 150 mm to 50 mm. The changed model is shown on Figure 6. It can be clearly noticed that the changed value of cover depth is approaching the threshold where clearly expressed results are lost.

5. EXPERIMENTAL EXAMPLE

The aim of experimental example was focused on densely reinforced elements. The subject of testing was deck slab of the bridge 11 in Lot 4 Ring road over Belgrade (Figure 7). The bridge deck slab is designed as a full deck slab facilitated with Styrofoam. The upper and lower zone of the deck slab is heavy reinforced with 32 mm diameter bars. In the transverse sense, 9 rows of Styrofoam rollers were installed. The rollers are 90 cm in diameter and the axial distance between the rollers is 130 cm (Figure 8 and 9).

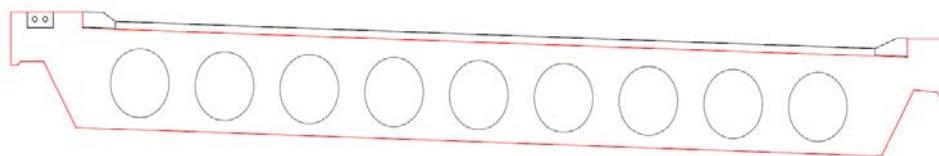

Figure 7. Cross-section of decking slab



Figure 8. Deck slab



Figure 9. Deck slab reinforcement

To keep the styrofoam rollers at the projected position, the Contractor has installed 2 cm wooden slats along the extensions. A reinforcement mesh was laid over the rollers thus formed. The reinforcement mesh is tied to the installed reinforcement, which prevents the movement of the Styrofoam rollers.

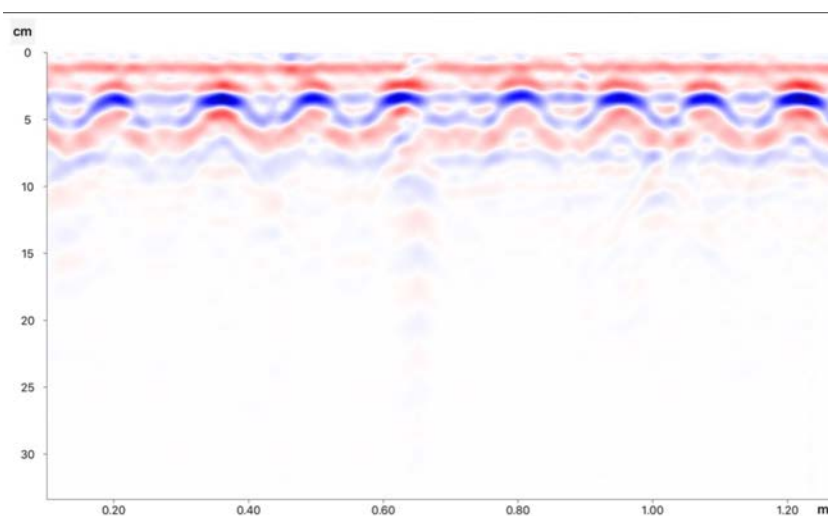

Figure 10. GPR live line scan

Proceq GPR Live GP8800 were used (Figure 10 and 11). As can be seen on figures, heavy and densely reinforced bars have been successfully identified. The aim of the experimental work was to investigate the possibility of scanning large diameter reinforced bars at a clear distance of 10-12 cm. GP8800 makes clear that it is possible to compare software modelled and in-situ scanned data.

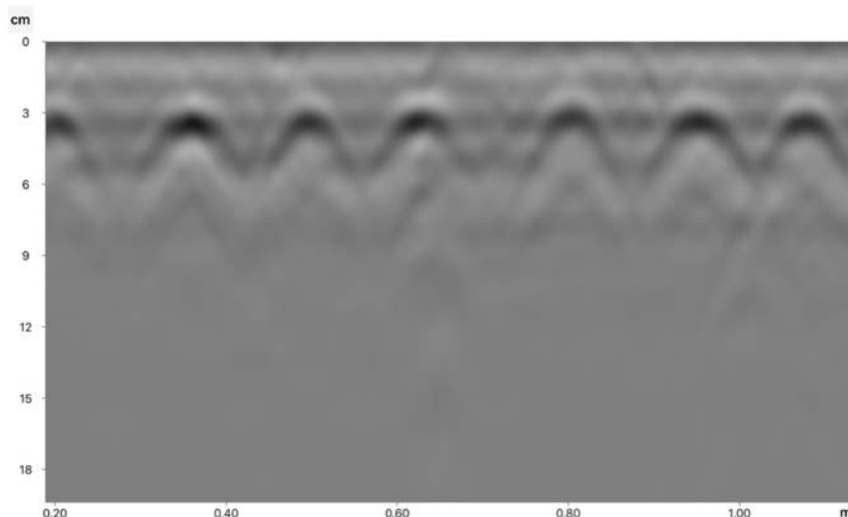

Figure 11. GPR live line scan - radargram

6. CONCLUSIONS

Non-destructive technique of GPR has been successfully implemented to detect the foreign entities and anomalies in concrete elements. Using this approach, it has been possible to monitor the various type of defects or eliminate doubt that something has not been performed according to the technical documentation.

Numerical modelling of GPR is very useful in enhancing our understanding of the GPR detection mechanism. The GprMax suite of programmes allows the simulation of realistic scenarios encountered in everyday use of GPR. As computer power is constantly increasing GPR modelling will become an important tool in training new GPR users as well as improving data interpretation of complex GPR sections.

The presence of steel rebars, which were covered with the concrete layer, could be detected clearly with ease and this is noticeable. The position of rebar from the top surface is seen at 30-50 mm in the depth profile of concrete element. Two layers of rebar could also be detected. It can be seen in the form of triangular shaped ripples separated by the second black thick strip.

GPR provides an efficient and versatile means for detecting rebars in the reinforced cement concrete slabs in rigid pavements along with their real depths and rebar array dimension. Single layer and double layer rebars have been successfully detected due to the use of advanced hardware and software features of the system being used.

LITERATURE

- [1] S. Koppenjan, "Ground Penetrating Radar Systems and Design," in *Ground Penetrating Radar Theory and Applications*, 1st ed., H.M. Jol, Ed. Amsterdam:Elsevier Science, 2009, pp.73-99.
- [2] J. Hugenschmidt, "Ground Penetrating Radar For The Evaluation of Reinforced Concrete Structures," in *Non-Destructive Evaluation of Reinforced Concrete Structures - Non-Destructive Testing Methods*, 1st ed., Vol2., C. Maierhofer
- [3] H.W. Reinhardt and G. Dobmann Ed. Cambridge: Woodhead Publishing Limited, 2010, pp.317-369.
- [4] M. Gehrig, M. Derek and J. Bryant, "Ground Penetrating Radar for Concrete Evaluation Studies," *Technical Presentation Paper for Performance Foundation Association*, Voll1, pp.1-17, 2004.
- [5] X. Xie,P. Li,H. Qin, L. Liu and D. C. Nobes, "GPR Identification of Voids Inside Concrete Based on The Support Vector Machine Algorithm ," *Journal of Geophysics and Engineering*, vol.10, 034002 pp.1-10, 2013.
- [6] Ł. Drobiec, R. Jasinski and W. Mazur, "Accuracy of Eddy-Current and Radar Methods Used in Reinforcement Detection," *Materials*, Vo., 12, 1168 pp.1-24, 2019.
- [7] A. Giannopoulos, "Modelling ground penetrating radar by GprMax," *Construction and Building Materials*, vol. 19,pp. 755–762, 2005.

- [8] G. Tronca, S. Lehner, L. Raj, I. Tsalicoglou, J. Meier and R. Mennicke, "Looking into concrete – multiple frequency usage in radar products to detect structural parameters and defects faster and more accurately," in 15th Asia Pacific Conference for Non-Destructive Testing (APCNDT2017), ID274/3963 pp. 1-8, 2017.
- [9] K. A. Lakshmi and A. Rahamath, "Estimation of Rebar Diameter Using Ground Penetrating Radar," *International Journal of Advances in Scientific Research and Engineering*, vol. 3, pp. 370-376, 2017.
- [10] H. Rathoda, S. Debeck, R. Gupta, B. Chow, "Applicability of GPR and a rebar detector to obtain rebar information of existing concrete structures," *Case Studies in Construction Materials*, vol. 11, e00240 pp.1-11, 2019.
- [11] D. P. Bigman, *GPR Basics: A Handbook for Ground Penetrating Radar Users*. Suwanee, USA: Bigman Geophysical LLC, 2018, pp.33-87.

62

Professional paper I Стручни рад
DOI 10.7251/STP2215635P
ISSN 2566-4484



Milan Prokopić, University of Belgrade, milanprokopic@gmail.com
Aleksandar Savić, University of Belgrade, sasha@grf.bg.ac.rs
Stefan Marjanović, University of Belgrade, marjanovic_stefan@yahoo.com
Predrag Petronijević, University of Belgrade, pecap@grf.bg.ac.rs

ANALYSIS AND EXPERIMENTAL TESTING OF PHYSICAL AND MECHANICAL PROPERTIES OF FLOORING EPOXY

Abstract

Epoxy resins are a class of reactive oligomers and polymers with epoxide groups. Depending on the type of epoxy and the hardener used, the curing (hardening) process can be regulated. Consequently, epoxy resins can be characterized by the "working time" or pot-life - the time it provides for certain technological operations to be performed with it. In the hardened state, epoxies are characterized by high strengths and high chemical resistance. Among other applications, they are widely used as materials for industrial floors, and for waterproofing. Laboratory optimization tests have shown that high strengths can be achieved with a lower density, and that the use of quartz filler does not necessarily improve the strength of the epoxy.

Keywords: epoxy, laboratory tests, physical and mechanical properties

АНАЛИЗА И ЕКСПЕРИМЕНТАЛНО ИСПИТИВАЊЕ ФИЗИЧКИХ И МЕХАНИЧКИХ СВОЈСТАВА ЕПОКСИДА ЗА ПОДОВЕ

Сажетак

Епоксидне смоле су врста реактивних олигомера и полимера који поседују епоксидне групе. У зависности од типа епоксида и употребљеног очвршћивача, процес неге (очвршћавања) може се регулисати. Последично, епоксидне смоле се могу карактерисати "радним временом" (pot-life), односно временом које је потребно да се обаве одређене технолошке операције. У очврслном стању, епоксиди се карактеришу високом чврстоћом и високом хемијском отпорношћу. Између осталих намена, они се широко употребљавају за индустријске подове, као и за остваривање водонепропустљивости. Оптимизацијом и лабораторијским испитивањима показано је да се са нижом запреминском масом могу постићи сличне чврстоће, као и да употреба кварцног пуниоца не резултира обавезно побољшањем чврстоће.

Кључне ријечи: епоксиди, лабораторијска испитивања, физичка и механичка својства

1. INTRODUCTION

The amounts of epoxy resins manufactured and consumed are insignificant in comparison with polyethylene, polypropylene and polystyrene. Even when resins such as polyesters and polyurethanes are considered, the amounts of epoxy resins produced are smaller. But in terms of complexity of technology, variety and breadth of application, epoxy resins are surely superior to all other plastics and resins. There is hardly an industry in which these resins are not used, and are especially used in construction [1]. They find applications in electrical and electronic devices and oil wells, in space satellites and stained-glass windows, on roads and bridges and in computers, in skis, and in supersonic aircraft. They form the basis of high-performance paints which are used on ships, automobiles and as food can linings. They are used in the factory, the artist's studio, the laboratory and in the home.

Epoxy resins can be used as adhesives, sealing compounds, casting resins, dipping compounds, molding powders, paints and varnishes. powder coatings, flooring and anti-skid surfacing, and as the resin matrix in reinforced composites. When in these various forms, they can be manipulated by hot or cold spraying, brushing, roller coating and all the other paint application methods, knifing, dipping, pouring, high- and low-pressure compression molding and injection molding. The reasons for this diversity of applications lie in the fundamental properties of the resins. Thus, during cure, no volatiles or other by-products are formed and volumetric shrinkage is very small of the order of -2%. The fully cured epoxy resin systems have the well-known properties of outstanding adhesion to many substrates, chemical resistance, toughness, mechanical strength, and high electrical resistance. Many variations of these properties can be achieved by adjustments in the formulation used.

1.1. BASIC EPOXY RESIN TECHNOLOGY

Epoxy resins, also known as epoxide or ethoxyline resins, contain the epoxy group which is the base of their structure. When manufactured, the resins are either liquids or solids and contain, on average, two epoxy groups per molecule. The resins are thermoplastic in this physical state, that is, they can be repeatedly softened by heat and hardened by cooling.

However, the essential feature of epoxy resin technology is the conversion of the resin into a hard, infusible three-dimensional network in which the resin molecules are crosslinked together by means of strong covalent bonds. This conversion can be termed "polymerization", but is more commonly called "curing" or "hardening" of the resin. The reagents that influence this change are known as "curing agents" or "hardeners". It is in this hardened (cured) form that the resins are almost always used; in the uncured, "non-crosslinked" state they are of limited use.

Hardening is an irreversible change and once the resin has been hardened, it cannot be recovered again in its original form. Hardening can be slowed down, stopped or speeded up, but it cannot be reversed. Hence resins fall into the category of thermosetting polymers, which, once polymerized, cannot be re-used by melting and reprocessing. Continued heating of a thermoset merely leads to softening and eventually degradation and breakdown of the material.

Some curing agents will react with the resins at room temperature or below, while others require heat to affect the polymerization, or the presence of the solvent. The curing reaction is exothermic, that is, heat is evolved during the crosslinking process, which causes an increase in the temperature of the system, sometimes 150-200°C or above.

The temperature level reached in any particular example will depend not only upon the reactivity of the resin and curing agent, but also upon the temperature of the reactants and of their surroundings, that is, upon the rate at which polymerization is occurring and the rate at which the heat evolved is being dissipated to the surroundings. Clearly, the ratio of the surface area to the mass of the reactants is important, as a large surface area would allow more heat to be dissipated compared with a smaller surface area for the same mass. This situation occurs if a mixture is being used as an adhesive rather than for casting purposes.

In practice, the attention is paid to ensure that the increase in temperature of a bulk mixture of resin and curing agent is not excessive. In the absence of such control, bubbling, cracking, charring and even complete degradation of the resin could occur in severe cases.

The time taken from the initial mixing of the resin and curing agent to the point when the viscosity of the mixture has become so high as to render the mix unusable is called the "pot life" of the system. This time is therefore the practical working life of the mix, during which the material must be applied efficiently. To a large extent, the pot life is influenced by the same factors that affect the exotherm, and pot lives can vary from a few seconds to several weeks, such is the wide range of possibilities with epoxy resin formulations.

To a large extent, the pot life is influenced by the same factors that affect the exotherm reaction, and pot lives can vary from a few seconds to several weeks, such is the wide range of possibilities with epoxy resin formulations. The pot life is also dependent upon the intended application of the system; thus, a viscous mixture may still be pourable into a mold, but would not be suitable for glass-fiber impregnation in a laminating process.

The simple resin-curing agent combination alone seldom provides a material with all the properties required for use in a given application, and other materials must be added so as to modify the properties of the cured resin or to make it cheaper. The correct choice of the types and amounts of the different components of an epoxy formulation is fairly precise, difficult and important task because the final properties and eventual performance of the system depend upon it. The various classes of materials that can be added to the resin and curing agent combination are in Table 1.

Table 1. Some of the different classes of materials that can be added to the resin-hardener mixture

Diluents	Liquids used to reduce the viscosity of the mixture
Inert fillers	Mainly used to make the system cheaper and to modify the physical and mechanical properties such as thermal conductivity and expansion, hardness and compressive strength
Fire retardants	Techniques employed to improve the fire-retardant properties of the cured resins mostly involve the incorporation of bromine or chlorine atoms into the system, usually by utilizing halogenated epoxy resins or chlorinated curing agents
Resinous modifiers	These systems have enhanced properties in certain respects over the properties of the individual, separate resins
Cure accelerators	Certain simple substances can increase the rate of reaction between the epoxy resins and some curing agents

Some modifying materials frequently perform more than one function at the same time [2].

1.2. ADVANTAGES OF USING EPOXY RESINS

For the designer and architect, the problem of material selection is often very complex and difficult. There is a bewildering variety of materials and processes available, and it is not easy to obtain a balanced and unbiased assessment of the merits and demerits of any individual material or group of materials from the information available. Load-bearing materials can illustrate the breadth of choice which confronts the design engineer. The range of suitable materials can extend from the traditional structural materials such as stone, wood, metals and concrete to the thermoplastic and thermosetting polymers, and to composite materials in which the stiffness and/or strength of a material is greatly enhanced by its combination with another material.

The relative advantages of epoxy resins have been discussed by a number of authors elsewhere, for example by Alexander [2], [3] and Miller [4]. Besides the basic advantages of epoxy resins, a question has to be answered why epoxy resins have been used for certain applications instead of another polymer or traditional material; what advantages epoxy resins have over other materials, and how these advantages can best be exploited. Plastics in general offer a combination of properties that are often superior to other materials in many respects. For example, plastics can have:

- The ability to be molded directly into complex shapes,
- High electrical resistance,
- High corrosion and chemical resistance,
- Optical clarity,
- High strength to weight ratios,
- Attractive surface texture and color.

In a similar way to metals, certain plastics can also be processed by mass production methods in which the product is made with consistent and reproducible accuracy. In contrast, large structures in glass-reinforced plastics are laid up by hand as single units.

1.3. COMPARATIVE ANALYSIS OF PROPERTIES

Some general physical and mechanical properties of an unfilled casting epoxy resin (such as specific gravity, thermal conductivity, coefficient of thermal expansion, hardness, tensile and compressive strength, elongation at break, modulus of elasticity) are given in Table 2.

Table 2. General physical and mechanical properties of an unfilled casting epoxy resin [3,4]

<i>Property</i>	<i>Value</i>
<i>Specific gravity</i>	<i>1.2-1.3 g/cm³</i>
<i>Thermal conductivity</i>	<i>4-5 x 10⁻⁴ cal/cm/s/deg C</i>
<i>Coefficient of thermal expansion</i>	<i>5-9 x 10⁻⁵ cm deg C/cm</i>
<i>Hardness</i>	<i>100-110 (Rockwell M scale)</i>
<i>Ultimate tensile strength</i>	<i>28-91 MPa</i>
<i>Elongation at break</i>	<i>1-8 %</i>
<i>Modulus of elasticity</i>	<i>1.4-3.5 GN/m²</i>
<i>Ultimate compressive strength</i>	<i>70-210 MPa</i>

A unique approach to the comparison of structural materials was made by Alexander [3,4] who compared the cost of "1 ton of strength" for various structural materials. Assuming an average manufactured cost of an epoxy-woven glass laminate of £4000/ton, the cost per ton per unit tensile strength was calculated to be 2.44 £/cm². On the same basis, the cost of structural steel was 0.19 £/cm², the cost of concrete 0.19-0.24 £/cm², timber 0.32-0.45 £/cm², copper castings 0.38-0.45 £/cm² and brass strip 1.1 -1.92 £/cm². Clearly, on the basis of this analysis, there was no clear reason why an epoxy laminate, or any other polymeric system, should replace steel or reinforced concrete at that time (1967). The data used to arrive at these costs should naturally be brought up to date if this approach is to be used today by an engineer, but on the contrary, this approach raises a question why epoxy or polyester-glass laminated pipes, for example, have ever replaced steel pipes. Clearly, it is not sufficient for material selection to be based on each property alone. A cost-benefit analysis should be carried out on each property of the material and additionally, on the other relevant aspects of the manufacture and use of the particular item under consideration.

The versatility of the resins and the advantages that can result from using them are really unique. The leading features of epoxy resins are:

- The ability to be cured rapidly or slowly over a wide range of temperatures,
- The ability to be processed by a large number of different techniques,
- The absence of volatile by-products formed during the curing reaction,
- Low shrinkage during cure,
- Excellent adhesion to many different substrates,
- A high level of mechanical strength, which is retained at elevated temperatures,
- Outstanding toughness,
- Good electrical properties,
- Excellent chemical resistance.

2. EXPERIMENTAL TESTING OF PHYSICAL AND MECHANICAL PROPERTIES OF EPOXY

The experimental tests were conducted on the epoxy resin "MC-DUR 1320 VK", of German production. As a transparent epoxy resin, it is recommended by the manufacturer for use in parking lots and industrial facilities. Technical values and product characteristics for MC-DUR 1320 VK are given in Table 3.

Table 3. Technical data for the applied epoxy resin [7]

<i>Property</i>	<i>Unit</i>	<i>Value</i>	<i>Comments</i>
<i>Mixing ratio</i>	<i>mass fractions</i>	<i>5:1</i>	<i>base : hardener content</i>
<i>Density</i>	<i>g/cm³</i>	<i>approx. 1,5</i>	-
<i>Viscosity</i>	<i>mPa`s</i>	<i>approx. 2400</i>	<i>at +20 °C and 50% rel. humidity</i>
<i>Working time</i>	<i>minutes</i>	<i>approx. 45</i>	<i>at +20 °C and 50% rel. humidity</i>
<i>Accessible after</i>	<i>hours</i>	<i>approx. 12</i>	<i>at +20 °C and 50% rel. humidity</i>
<i>Resilient after (full)</i>	<i>days</i>	<i>7</i>	<i>at +20 °C and 50% rel. humidity</i>
<i>Application conditions</i>	<i>°C</i>	<i>>10- <30</i>	<i>air and substrate temperatures</i>
	<i>%</i>	<i><85</i>	<i>rel. humidity</i>
	<i>K</i>	<i>3</i>	<i>above dew point</i>
<i>Consumption</i>	<i>kg/m²</i>	<i>~ 0,3</i>	<i>primer</i>
	<i>kg/m²</i>	<i>~ 0,7</i>	<i>scratch and levelling coat</i>
	<i>kg/m²</i>	<i>~ 0,9</i>	<i>for strewing layer</i>
	<i>kg/m²</i>	<i>~ 1,2</i>	<i>quartz leveling layer</i>

Samples were made by following the instructions from the technical sheet. The epoxy resin was poured into molds so that prismatic samples 4x4x16 cm were obtained. They were left to stand for two weeks at room temperature. Samples were made in the ratio 1: 5 = resin: hardener, as well as 1.5: 1 = MC DUR 1320 VK: quartz (0.1 - 0.3).

The test was performed on two types of samples: pure epoxy samples, and on samples with quartz filler. The experiment was done in two phases. The first phase was done with the 200 kN Amsler hydraulic press. Flexural strength and compressive strength were tested on three 4x4x16 cm prismatic specimens, which had previously hardened in the mold. It is important to note that the samples hardened for one month, instead of the prescribed one-week time. The reason for the longer hardening was the thickness of the prismatic sample of 4 cm, instead of the usual few millimeters, as much as this coating should be applied in practice, and the consequent slower hardening of inner material. The appearance of the samples and measurement of their weight are shown in Figure 1.



Figure 1. Epoxy samples and the measurement of mass

The results of testing of density, flexural and compressive strength are given in Table 4.

Table 4. Density, flexural and compressive strength of the tested epoxy resin

<i>Density</i>	<i>Mass (g)</i>	<i>Volume (cm³)</i>	<i>Density (g/cm³)</i>	<i>Average density (kg/m³)</i>
	287,9	254.24	1.132	1128
	286,5	249.6	1,148	
	288,0	260.76	1,105	
<i>Flexural strength</i>	<i>Ultimate load (kN)</i>		<i>Average (kN)</i>	<i>Average flexural strength (MPa)</i>
	10,1	9,1	10,3	25,8
	12,1	10,3		
	10,9	9,4		
<i>Compressive strength</i>	<i>Ultimate load (kN)</i>		<i>Average (kN)</i>	<i>Average compressive strength (MPa)</i>
	96	101	98,7	61,7
	95	102		
	94	104		

In the second phase, a "Pull-off" test, in order to obtain bond strength, was performed. The samples were made as a 2 mm cover over the C35/45 concrete plates, in two series – one with and the other without quartz filler. The epoxy cover is shown on Figure 4, and the results of the tests are given in Table 5.



Figure 2. Surface with, and without quartz filler (left) and the apparatus used (right)

Table 5. The obtained bond strength results

	<i>Pure epoxy</i>	<i>Comparison</i>	<i>Epoxy with quartz filler</i>	<i>Fracture</i>
1.	7,54 kN – 3,84 MPa	>	6,57 kN – 3,34 MPa	Fracture of the concrete
2.	7,28 kN – 3,71 MPa	<	9,33 kN – 4,57 MPa	Fracture of the concrete
3.	8,76 kN – 4,46 MPa	>	7,72 kN – 3,93 MPa	Fracture of the concrete

3. DISCUSSION

The obtained values of density ranged between 1105 kg/m^3 and 1148 kg/m^3 , with the average of 1128 kg/m^3 . Generally, these values are expectedly lower than the values for mortar and concrete, and lower than the values given in the technical data sheet. The values of flexural and compressive strengths ($25,8 \text{ MPa}$ and $61,7 \text{ MPa}$, respectively), obtained on $4 \times 4 \times 16 \text{ cm}$ prisms (Fig. 5) are uniform and moderately high. In comparison to the cement composites, and having in mind ranges of the values expected for epoxy resins, it can be noted that they have reached satisfactory strengths.



Figure 3. *Compressive strength test using Amsler hydraulic press*

The pull-off strengths were obtained in the second phase. On the basis of the results that ranged between $3,71$ and $4,46 \text{ MPa}$ for the epoxy with quartz, and between $3,34$ and $4,57 \text{ MPa}$ for pure epoxy without quartz, the observation is that very similar bond strengths were obtained.

4. CONCLUSIONS

Although not a relatively new material, and although it has various applications, epoxy is not used as often, compared to other competing materials. The most likely reason for this problem is their price. In the case of industrial floors, investors mostly lean towards the cheaper solutions, without considering the long-term benefits of such floors. Therefore, besides the importance to perform according to the instructions, regulations and correctly, laboratory tests can help to confirm the results, and to opt the performances.

Testing of epoxy, normally used as a coating for industrial floors, was done on prismatic samples measuring $4 \times 4 \times 16 \text{ cm}$, and without any filler. After a prolonged curing period, density of 1128 kg/m^3 was obtained, while the flexural and compressive strength reached $25,8 \text{ MPa}$ and $61,7 \text{ MPa}$ on average, respectively. The curing period had to be longer because the prescribed thickness for this material is only a few millimeters. Based on the investigated physical and mechanical properties of epoxy, it could be concluded that the use of this type of epoxy showed lower density and competitive values of compressive and flexural strength, meaning that high mechanical properties can be achieved even for lower density of the material. On the basis of bond strength test, it could be concluded that quartz filler slightly contributes to the improvement of strength, compared to pure epoxy sample. This effect was most likely due to the different procedure of the epoxy casting, than the one practiced on industrial floors. Also, quartz filler would significantly improve the anti-slip properties of epoxy coatings, but this test was not conducted. Regarding pot-life, a conclusion can be made that it was acceptable, and didn't induce additional time dependent stresses on the process of casting.

Future developments in epoxy formulations intended for parking lots and industrial floors include: price reduction, automated production of such floors (typical sizes of floors $1000\text{-}3000 \text{ m}^2$), increased speed of placement, as well as changing the consciousness of future users due to their

long-term advantages and possibilities. However, there are certain limitations in the use of these resins, such as their sensitivity to water and toxicity. Also, in order to ensure that epoxy floors maintain their high application rate and to be present in the industrial flooring market, improvements will need to be made in the following areas:

- Sand-filled floors often wear excessively if they are subjected to wet trucking, probably owing to sand worn from the surface forming a „grinding paste“ and causing rapid wear.
- For the efficient laying of trowelled floors, skilled labour is required. A mechanical means of laying would speed up the process and decrease the necessity for skilled manual trowelling.
- Epoxy floors will need to be made resistant to steam cleaning. At present they are failing, possibly due to the difference in the coefficients of thermal expansion of the floor and sub-floor concrete, or to the increase in the vapour pressure of the moisture held in the concrete sub-floor.

LITERATURE

- [1] M. Muravljev, Građevinski materijali, Beograd: Građevinska knjiga, IV izdanje, 2000
- [2] W. G. Potter, Epoxide Resins, London:Butterworths, 1970
- [3] W. O. Alexander, Contemporary Physics, 8, No. 1,5, 1967
- [4] W. O. Alexander, Futures 1, No. 6, 500, 1969
- [5] W. G. Miller, Br. Plast., 44, No. 10, 93,1971
- [6] Shell Chemical co. Technical Literature.
- [7] MC-Bauchemie: MC-DUR 1320 VK Technical datasheet, 2020

63

Professional paper I Стручни рад
DOI 10.7251/STP2215643K
ISSN 2566-4484



Hristina Krstić, University of Niš, hristinaa@hotmail.com
Vladana Petrović, University of Niš, s.vladana@gmail.com
Milica Živković, University of Niš, dia.milica@gmail.com
Slaviša Kondić, University of Niš, skondic555@gmail.com
Katarina Medar, University of Niš, katarinamedar@gmail.com

THE AMBIVALENCE OF SPACE IN HOUSING ARCHITECTURE AS A RESULT OF LAYERED ARCHITECTONIC STRUCTURE

Abstract

Space that cannot be precisely defined by certain conventional spatial category (for example as interior or exterior), because it takes over the characteristics of various spaces, expresses ambivalent features. Such a spatial category often occurs in complex architectonic structures, that are created by the insertion of spatial layers one within another. Its presence enriches the spatial experience of the architecture and contributes to the creation of unique ambience values, that affect the residents' lives. This paper has the goal to investigate the spaces of this kind in housing architecture and to determine their importance in the terms of housing comfort.

Keywords: ambivalent space, layered architecture, housing architecture

АМБИВАЛЕНТНОСТ ПРОСТОРА У СТАМБЕНОЈ АРХИТЕКТУРИ КАО РЕЗУЛТАТ СЛОЈЕВИТЕ АРХИТЕКТОНСКЕ СТРУКТУРЕ

Сажетак

Простор који се не може прецизно дефинисати неком конвенционалном просторном категоријом (нпр. као ентеријер или ектеријер), јер поприма карактеристике разних простора, изражава амбивалентне особине. Оваква просторна категорија се често јавља у сложеним архитектонским структурама које настају уметањем просторних слојева једног унутар другог. Њено присуство обогаћује просторни доживљај архитектуре и доприноси стварању јединствених амбијенталних вредности, које утичу на живот станара. Овај рад има за циљ да истражи просторе ове врсте у стамбеној архитектури и утврди њихов значај у погледу стамбеног комфора.

Кључне ријечи: амбивалентни простор, слојевита архитектура, стамбена архитектура

1. INTRODUCTION

Between open and closed, between in and out, between private and public, between light and dark, between past and future... the line is as narrow as it is wide. But, what happens when those opposites meet in the course of time, place and content? How do they interact with the structure? How do they move the architecture? How strong is the power that occurs when opposites collide?

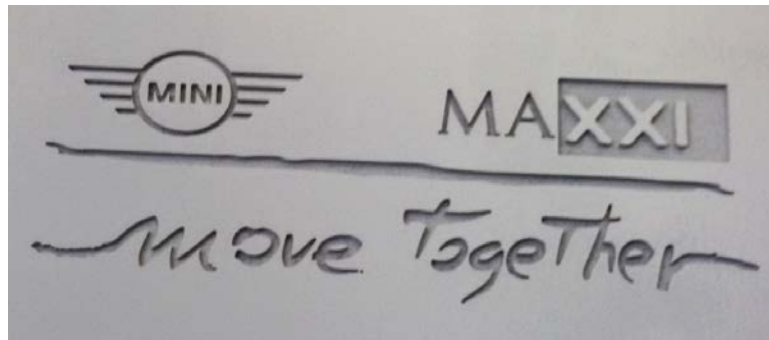

Figure 1. *MINI and MAXXI move together, motto of the Museum MAXXI in Rome, photo taken in 2017 during the exhibition: "The Japanese House. Architettura e vita dal 1945 a oggi", Museo Nazionale delle arti del XXI secolo - MAXXI, Rome*

Although the precise definition of space hasn't been specified yet, and would probably never be due to subjectivity of its perception, still the space remains the most important element of any architecture. When it comes to buildings, normally we single out two spatial categories: interior and exterior, whereby each has its own specific characteristics. If in some case, it happens that design concept messes a bit with those commonly established categories, we get to the point where it is hard to clarify the nature of each. We get confused. The boundary is blurred. We get to the space that can be either this or that. We get to the ambivalent space.

This kind of "spatial mess" is particularly characteristic in so called *space within a space concept*, a concept of spatial organization of an architectonic structure that bases its principles on the idea of nesting of a space inside a certain space, i.e. on the insertion of a smaller spatial whole within a larger spatial whole or wrapping a larger spatial whole around a smaller one in a certain sequence. [1] By inserting or wrapping, the architectonic composition of the building becomes layered and the number of layers can vary, depending on a case. Stretching from the inside to the outside, layers create a set of different spatial entities that interact with each other. Those spaces, that are placed between most inner and most outer part of the composition, also called *in between spaces* [2], are usually characterized as ambivalent spaces, because they take over the characteristics of different kind and possess very rich ambient value, which makes them be consider as an important element in spatial organization of the building. Such spaces create particular atmosphere, enhance the user's interaction within the building and reinforce the experience of the space.

This paper has the task to investigate the value of ambivalent space in housing architecture and its importance and contribution to the living comfort. The aim is to find out to what extent such spaces affect the quality of housing space and do they play any important role in the improvement of residents' lives. The paper is based on the short case studies, which will, through the further comparative analysis and synthesis of the obtained results, based on the induction-deduction method, lead to a certain conclusion.

2. SPATIAL CATEGORIES IN ARCHITECTURE

As the space is essential element in architecture, the one that creates architecture and the one that is created by architecture, it remains ever-actual topic. Many authors (Sigfried Giedion [3], Christian Norberg-Schulz [4], Frank Ching [5], Bryan Lawson [6] etc.) dealt with the problem of space. According to Dursun [7], space forms the core of architecture. Although the perception of space is variable category, having in mind that not every individual experiences the same space in the same way, most of the people have the clear idea about the classification of the space into inside and outside domain (interior and exterior).

Finding the similarities that exist between the architecture and nature (in and out), Japanese architect Sou Fujimoto [8], in the most of his projects (House N, House NA, House before House etc.),

confronts those opposites and investigates the relationship between them. As he explains¹¹, nature (whereby nature is not only considered as the physical greenery, but is also the wind, the air, the water, our body itself) and the architecture (manmade environment) are visually completely different or opposite, but the structure behind them is in a sense almost the same. Outside is more nature and inside is more architecture, but what happens, he asks, if we try to blur the boundaries and then the nature and the architecture, the outside and the inside, get closer. Trying to answer this fundamental question, he explores the space in-between opposing ideas: "I like to find something in-between. Not only (between) nature and architecture, but also (between) inside and outside. Every kind of definition has an in-between space. Especially if the definitions are two opposites, then the in-between space is more rich" [9].

German architect Oswald Mathias Ungers, a great part of his work dedicated to the research of the conceptual ideas that lie behind the scene of an architectural structure [10]. Apart from the other themes, he particularly dealt with the *space within the space idea*, or as he called it *doll inside the doll*, where he introduced new spatial categories in the spatial structure of the architectonic composition, as opposite to basic ones.

Many contemporary architects, among which also well-known Portuguese duo Aires Mateus [11], often base their architecture on the confrontation of opposite elements in order to create space of a particular atmosphere, where the structure is no longer considered only as a shelter for those who live inside, but as the place that triggers emotions, experiences and development.

Observing the works of abovementioned architects, it turns out that in many cases, the key moment in an architectonic composition of the structure is actually the space that is maybe not strictly pre-defined or not noticeable at the first glance, but emerges in the field where different, more dominant, elements or influences meet and interact, giving the space specific ambivalent character. Attracted and inspired by this "mystic" moment, it arose the need for a deeper examination of the phenomenon. The topic of ambivalent space is chosen as an interesting phenomenon always actual in the field of architecture. Although it is widely present, here, in the research, the topic is narrowed and focused on the housing architecture, with the main goal to clarify the characteristics of such a space and its importance and contribution to the value of the living space. The problem will be approached mostly from the phenomenological and functional point of view, through the analysis of the projects which were chosen to be present as case studies.

3. CASE STUDIES

The main selection criteria for the projects was diversity of approaches on the similar recognized topic.

3.1. PROJECT GLASS HOUSE (AUTHOR: PHILIP JOHNSON; LOCATION: NEW CANAAN, USA; YEAR: 1949)

Glass House is one of the best examples in housing architecture where ambivalent space dominates the architecture. Designed as a very simple structure, both in shape and function, it consists of a single transparent volume that unifies the content of the house. Functional organization in Glass House is based on an open-plan, where the functions are combined throughout one continuous space. There are no walls, and the furniture is the only element that defines the areas of use, subtly dividing the house into day and night zone. The only space set aside, as the most private one, is the bathroom, unified together with fire place, hidden inside a bricked cylindrical volume. Since the outer envelope of the house is completely transparent, the views from the interior of the house towards the nature and vice versa are open in all directions, without any barrier. This strong extrovert design approach results with the space that cannot be clearly defined as inside or outside space. Physically it is protected space, i.e. the interior, but visually that space blends perfectly with the surrounding nature, creating a continuum with no boundaries between. One can have a feeling of living outside, while being inside the house. Transparent envelope is present in the composition at the same time to set the boundary between two spatial categories and to allow their constant interaction, creating in this way an in-between layer, where residents actually live in a constant symbiosis with the environment. Although the presence of nature is always favorable, the extrovert building yet dictates a radical way of living, which means that this kind of architecture cannot be accepted by every user and is quite subjected to its personal preferences.

¹¹ Urban talks: Sou Fujimoto, The Center for Architecture and Metropolitan Planning (CAMP), Prague, 2019.

Table 1. Tabular presentation of the analyzed projects

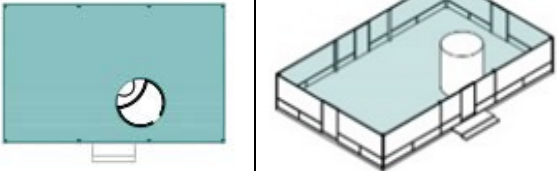
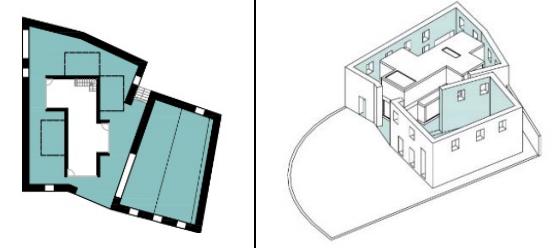
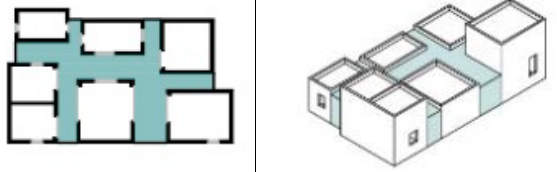
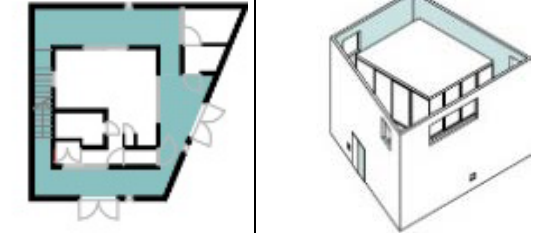
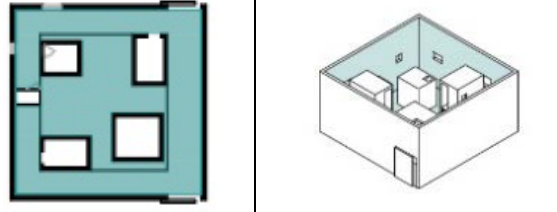
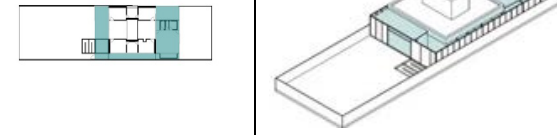
PROJECT	AMBIVALENT SPACE <i>*sketches made by authors, based on the architect's drawings</i>		CAUSATION	RESULT
Glass House			- Transparent envelope.	- Strong bound between the living space and the nature
House in Alenquer			- Existing external walls kept from the previous building on a site.	<ul style="list-style-type: none"> - Gradual spatial switch from the inside of the composition to the outside. - Specific experience that gives an impression of the artistic spatial perception.
House in Buzen			- Structural decomposition.	Unification of inside and outside functional contents.
Inside Out House			- Perforated volume around the house.	The house that is the equal home both for people and animals living there.
Light walls House			<ul style="list-style-type: none"> - Extrovert architecture. - Organizational scheme copied from the urban pattern. 	- The mixture of public and private characteristics.
House in a House			- Layered spatial form.	<ul style="list-style-type: none"> - Gradual spatial switch from the inside of the composition to the outside. - Changeable structure that follows the weather conditions.

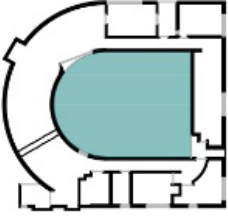
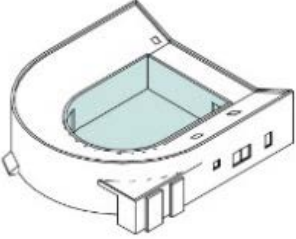
House U			<p>- Closed introvert U shaped structure.</p>	<p>- The house as a world unto itself. - Spiritual and sculptural expression.</p>
---------	---	--	---	---

3.2. PROJECT HOUSE IN ALENQUER (AUTHOR: AIRES MATEUS; LOCATION: ALENQUER, PORTUGAL; YEAR: 2002)

House in Alenquer, the project that in a very original way combines new and old architecture, expresses strong presence of ambivalent space, that comes from the design concept which relies on the direct combination of opposites: existing and new, subtracted and added, solid and void, shade and light.

The architectonic composition is created inside of the perimeter external walls from the old building which are kept and reconstructed [12], while new building, together with a pool, is inserted inside of them. In the conflict of contrasts created by the insertion of one structure into another, emerges the space of a very specific character, which takes on the characteristics of both old and new structures and becomes an important element within a newly created architectonic composition. The existing walls are accepted as an equal element that plays important role in creating a new perception of the old space. This perception should develop itself within the framework of the experience that arises when the new architecture approaches the old one, and when in their temporal encounter interactions appear, as a dynamic trigger of the architectural ambience.

Here, the design concept, based on the space within the space idea, expressed through a combination of existing and new structures, recognizes three spatial levels: the most inner (new house and pool), the most outer (garden) and one between them, defined by the remained walls [1]. This middle layer is the one that gives the particular significance to the architectural value and the one that mixes the characters of all the opposites that have taken part in the creation of the house. Since it emerges at the point where other two layers overlap, it can be considered both as the extension of the outer (like the closed garden) or the continuation of the inner (the open house) area. To be in this space leaves the unique feeling of being at the same time in and out, as well as in the past and present. It is some kind of the connection line that creates particular experience of the space, which also brings the artistic aspect to the spatial perception, having in mind the light and shadow play that is achieved by the perforations of the external shall.

3.3. PROJECT HOUSE IN BUZEN (AUTHOR: SUPPOSE DESIGN OFFICE; LOCATION: BUZEN, JAPAN; YEAR: 2009)

The architectonic composition of House in Buzen is very simple in its form and functional organization. The house is composed of six independent volumes, which are connected by a winding corridor. As the architects describe, the main concept lies on the idea of making *equal the relationship between inside and out by using courtyard as a part of everyday life and bringing inside activities outside* [13].

Except for the volume that combines two rooms for children, each volume fits one room (living room, dining area with a kitchen, main sleeping room, bathroom, wardrobe). The rooms are connected by the glazed corridor that runs around the volumes, simultaneously having a role of a garden and playground.

By the insertion of this glazed connecting volume, the initially compact structure has been decomposed into fragments, where domains of interior and exterior have been overlapped. [14] In this regard, based on the constant integration of inside and outside, a new ambivalent space has been created, where *an interior feels exterior, a private feels public, a hall feels like an avenue* [13].

3.4. PROJECT INSIDE OUT HOUSE (AUTHOR: TAKESHI HOSAKA; LOCATION: TOKYO, JAPAN; YEAR: 2010)

The Inside Out House is a structure designed to equally be home *for a married couple and two cats* [15]. That means, the house should provide a space that, at the same time, fits the humans and animals living together. It resulted in an unusual housing concept, in a set of the arrangements, that combine spaces of different characteristics – those oriented towards the open and enclosed. The

main structure of the composition is created by nesting two smaller volumes inside the one large perforated volume, which is placed on the plot. Perforated volume is the key element in the structure, that starts the spatial play. It works as the membrane between the real outside space and the filtered part that was brought inside, defining the mutual community where cats and people dwell together. Being closed associates to a shelter, while at the same time perforations indicate to a natural environment that penetrates inside. This is the primary house for animals (where they can run, lay beneath the sun, play) and the extended house for people (semi covered garden). Emerged right in the field where two spatial domains intersect, this huge spatial volume creates particular atmosphere that puts out together the characteristics of opposite spaces.

3.5. PROJECT LIGHT WALLS HOUSE (AUTHOR: MA-STYLE ARCHITECTS; LOCATION: TOYOKAWA, JAPAN; YEAR: 2013)

The design of the Light walls House is mainly caused by the location context. Since the plot, where the house is positioned, is very small and shaded by the surrounding buildings, main idea for the design lead to an introverted approach. The composition is completely wrapped inside the solid white cube, closed to the surrounding environment, but open to the sky. Lantern openings bring the diffuse light inside and distribute it around the huge inner open-space area which unifies the functional content in a very specific way. There are no usual partitions that divide the space into rooms, but instead, the interior is organized in a form of the scheme that reminds of the urban organization of the city [16]. More private areas (sleeping spaces) as well as auxiliary spaces are placed inside the enclosed small freestanding volumes, metaphor of buildings, while living and dining areas are conceived to be gathering places, metaphor of squares, and are placed between the enclosed volumes. Other common spaces, like kitchen, work space and wardrobe are lined up along the perimeter of the house. If we simplify the things, it can be said that the main structure of the composition is based on a huge box inside of which are inserted smaller boxes. Because the smaller boxes are visually secured, they retain the higher level of privacy, while the content that is distributed around reflects the sense of public. This content is still in the private space, since it is inside of the house, but compared to other spaces inside, it is placed in public domain of the house. And this is where the ambivalence arises - in the interweaving of public and private, whereby the term public has a dual meaning: the space defined by the external membrane in relation to the urban context is referred to be private, but in relation to the smaller volumes nested inside the big volume it can be comprehend as public.

3.6. PROJECT HOUSE IN A HOUSE (AUTHOR: PLURAL; LOCATION: BERNOLAKOVO, SLOVAKIA; YEAR: 2016)

In the project House in a House, the structure of living space is created by a gradual addition of the spatial layers from the center to the periphery of the architectonic composition. The most central element, the main core of the whole composition, is dining area, designed to be the focal point around which the rest of the functional content is spread, defining the primary living space - the enclosed part of the house. Further on, the enclosed house gradually opens itself to the front and back garden, through the unique transition space, that exudes dual character. This transition, semi open or semi closed space, depending on the point of view, combines content that is, by nature, intended for outdoor space, but since it's wrapped in partly transparent envelope, alludes to indoor space. The layer between the inside and the outside can be at the same time recognized as an open extension of the interior or closed continuation of the exterior. In wintertime, it can have a function of the green house, a winter garden, while during summer, by moving the sliding panels away, it connects itself to the front and back gardens, making a unity with them. In this way, the house follows the weather change, by periodical growth of its domain.

3.7. PROJECT WHITE U (AUTHOR: TOYO ITO; LOCATION: TOKYO, JAPAN; YEAR: 1976)

With the intention to make its own world within the urban context of the busy overcrowded city, the design of White U house uses particular spatial arrangement of a simple form to create an introvert structure compound of different spatial domains nested one within another. It could be said that the concept is mainly influenced by the request to use the living space as a tool that will help in strengthening the connection between family members: *The owner expressed a desire for a visual connection between different parts of the house.* [17] In this regard, the emphasis in the project is given to the symbolic value of the space and therefore comes the circular shape, that results in continuous structure wrapped around the atrium. Here, the atrium is not perceived only as courtyard, but rather as an equal part of the architectonic structure, which takes the important role in the

operation of the house. It can be recognized as an open room within the set of other spaces. Also, it plays another role as a detail that contributes to the spirituality of the building and its sculptural expression, in the game triggered by light and shadows.

4. DISCUSSION

In all projects of the houses, which are shown through case studies, it is recognized the strong presence of spatial categories that reflect a dose of uncertainty and ambiguity. They arise in the parts of the architectonic composition where the overlapping or intersection of certain spatial domains appears. Usually, they are imposed somewhere between clearly defined areas and operate in between, connecting them in a certain way. They may be created for a reason (for example in his works, Oswald Mathias Ungers uses the theme of incorporation called “the doll within the doll” to arrange the building’s organization; he creates the architecture based on the fractal idea of continuous flow where an object continues to turn up inside another object consciously and introduces this idea as a principle of design [10]) or may be the consequence of other circumstances (they appear as an accidental consequence of some other ideas). The researched projects show following causes of the occurrence of such spaces: the tendency to make a strong bond between living space and the environment, the way to band together structures from different contexts, the mode to find the unique space that works for various occasions, the unification of various houses in one single, the answer to the unfavorable location framework, the gradation of living space, spirituality of architectural expression.

Table 2. The main reasons of the emergence of ambivalent spaces in researched projects

PROJECT	REASON OF OCCURRENCE
Glass House	connection of living space and natural environment
House in Alenquer	confrontation of various opposites
House in Buzen	merging of indoor and outdoor functional contents
Inside Out House	overlapping of animals’ and people’s living space
Light walls House	contextual framework
House in a House	gradual shift from interior to exterior
White U	structure’s form

The ambivalent space in Glass House is in the first place caused by its transparency. The house is visually completely exposed to the surrounding area, which contributes the interior space to seamlessly merge with the environment. The nature is considered to be equal part of the house, like other spaces are, and vice versa, the house is conceived as natural element in the wider landscape. However, the strong relationship between the nature and the house, i.e. the close interaction between the living space and the surrounding nature, achieved in this way, causes the low level of privacy, which makes the house not be suitable for general population. The life inside such a space is, to a large extent, subjected to the individual preferences of a person. In Glass House the whole living space is actually ambivalent, except for the separated bathroom.

On the other hand, the ambivalent space in House in Alenquer is generated by the collision of various opposites. It is not only the overlapping of inside and outside domains, but the mutual interaction of different epochs, different shades, different forms. Each of the influencing factors has left its own trace, which lead to the space that radiates the unique atmosphere and experience for the one who finds himself in it. This space alludes also to the artistic moment of the building, giving it a sense of sculptural expression

Ambivalent space in House in Buzen is again caused by the mixture of inside and outside content. The complete organization of the house is subordinated to the merging of functions that are of different nature. What is especially interesting is the way in which the common space is organized. It meanders all around the composition, shaping it and giving it fragmental arrangement. The composition is, in a way, put upside down and the house is actually composed by decomposing [14]. So, also in this case, the ambivalent space expresses the connecting role, whereby the corridor is, apart from its basic purpose, used as garden, playground and rest area. Being in that space means at the same time being in the house and being outside the house. One is neither inside enough, nor outside enough.

In the Inside Out House ambivalent space is the direct result of overlapping of two houses - one adjusted to people and one adjusted to animals. It creates the region that is intended for coexistence of all house members, where animals are equal family members as people. In the intersection area of two houses occurs the space that meets all the needs together. It allows the nature to penetrate

inside to a certain extent – to the extent that is enough to provide the animals with the shelter and people with the garden and to allow them enjoy the sun, the rain, the breeze together within the structure they all call home.

Ambivalent space in Light walls House, caused by the introverted architecture and unusual house plan, primary lies on the gradual shift of private and public ambient inside the same architectonic composition. Gradation of the privacy and its impossibility of accurate definition create the space that is ambiguous and therefore diverse from conventional. The project is interesting because it introduces some new approaches to the housing design, that open up possibilities when it comes to spatial-functional organization of living space. However, being delicate in many aspects and affecting in a great manner the life style of the residents, it is questionable the wide acceptability of this design solution.

House in a House reflects ambient space as a direct consequence of concentric sequencing of different spatial levels between two endpoints. In this gradual sequence, one space slowly changes itself till it turns to other space. The way from the inside to the outside is not direct, but developed step by step through the insertion of spatial layers that enrich the transition way and are in constant interaction.

Finally, the ambivalent space in White U is mainly result of the building's form. The artistic moment, present here, also plays an important role. Solid and void parts of the composition, as well as light effects, have the significant function in the creation of the particular atmosphere that is based on ambiguous character.

Table 3. The colors show the level of influence of ambivalent space on the life in the house – black color represents the highest impact, while white color represents no impact.

PROJECT	THE INFLUENCE LEVEL
Glass House	
House in Alenquer	
House in Buzen	
Inside Out House	
Light walls House	
House in a House	
White U	

Spaces researched here consequently have impact on the life of dwellers. The table 3 shows the level of such impact, which is defined based on the previous project analysis and observation. The result shown in the table may not be fully objective, since the perception of space always lack the objectivity and is influenced by the personal preferences of the viewer's perspective, but is conducted upon the established criterions which tend to be objective in a great manner: the level of user residence in the space, the physical characteristics of the space, user exposure to the space out of the architectonic composition caused by the "ambivalent" zone.

According to the comparison made among researched projects (table 1), based on the motives of the appearance, it can be derived the classification of the structures into few groups:

- the group of structures where the ambivalent space is related to the tendency of connecting the interior space of the house with the environment;
- the group of structures where the ambivalent space is related to the poetic expression of the structure;
- the group of structures where the ambivalent space is related to the gradation of the spaces;
- the group of structures where the ambivalent space is related to the unification of contents of a different nature.

5. CONCLUSION

Existence of ambivalent space in spatial structure of a house can enrich the spatial experience of the architecture. Having in mind that *identity is closely related to the experience of space* [4], this space can be considered as crucial architectonic element in creating balanced and personalized structure. It offers different areas inside the same house under which residents can organize their lives, according to the current wishes and needs. If set in the relation between indoor and outdoor, those spaces act like filters between inside and outside world, between interior and exterior of the house. They can direct the influences from one side to another in a way that is convenient to residents. For

example, they can dose amount of light that can enter inside, the level of visual openness towards the surrounding etc. They create unique atmosphere for stay, that differs from the common one. The most emphasized advantage of such a space is the stronger relationship between inside and outside domains, mainly arranged in a gradual way. There is no sharp boundary, and the transition from one to another point within the architectonic composition is smoot. There are not only black and white, but the whole pallet of spaces is reinforced with the shades of gray that coexist among them.

The bivalent space can be introduced to the design by intention or can be the result of other tendencies or can even be created more or less by chance. Anyway, once set, it affects the internal relations and gives an opportunity to users to choose between the various spatial categories.

Based on the table 3, it can be concluded that ambivalent space influences the residents' life in any case, but depending on the situation, the influence level can be more or less strong. The most powerful impact is noticeable in the situations when its role is to make the link between certain spaces – indoor and outdoor or private and public. As a connecting element, it takes over the characteristics of both sides and, by mixing them, introduces a new spatial category of a very particular character. As it is explained in Elemental living [18], *a fine line exists between those houses that simply speak to their surrounding landscape, and those that both speak and respond to it, emphasizing the dialogue, as elementally important tool, without which the architecture can feel both anachronistic and out of touch.*

Finally, it can be derived the conclusion that the existence of ambivalent spaces in the architectonic composition of housing building is favorable, because they broaden the opportunities offered by the architecture and create a variety of new spaces that can be enjoyed. That means that they directly affect the development of housing quality and the improvement of residents' lives.

LITERATURE

- [1] H. Krstic, "Research of the architectonic space structure in the domain of housing – space within a space concept", PhD thesis, University of Nis, Serbia, 2018.
- [2] H. Krstic, A. Trentin, G. Jovanovic, "Interior-exterior connection in architectural design based on the incorporation of spatial in between layers", SPATIUM, No 36, pp. 84-91, Dec. 2016.
- [3] S. Giedion, Prostor, vreme i arhitektura – Razvoj nove tradicije, Beograd: Građevinska knjiga, 2012.
- [4] K. Norberg Šulc, Egzistencija, prostor i arhitektura, Beograd: Građevinska knjiga, 2002.
- [5] F. D. K. Ching, Architecture Form Space and Order, New York: Van Nostrand Reinhold, 1996.
- [6] B. Lawson, The language of space, Great Britain: Architectural Press, 2001.
- [7] P. Dursun, "Dialogue on space: Spacial codes and language of space", A|Z ITU Journal of the faculty of architecture, vol 9, pp. 104-119, 2012.
- [8] S. Fujimoto, T. Ito, J. Worrall, "Sou Fujimoto International Architecture Review", 2G International Architecture Magazine, vol. 50, 2009.
- [9] S. Knott (Discussion). "Sou Fujimoto: The spaces in-between.", Internet. <https://architectureau.com/articles/sou-fujimoto-the-spaces-in-between/>, Sep. 25, 2014 [Apr. 29, 2022].
- [10] O. M. Ungers, Architettura come tema / Architecture as theme, Milano: Quaderni di Lotus / Lotus Documents, Electa, 1982.
- [11] General de Ediciones de Arquitectura, "Aires Mateus, Arquitectura 2003-2020", TC cuadernos, vol 145, 2020.
- [12] Aires Mateus Arquitectos, "Works Aires Mateus Arquitectos", Arquitecturas de autor / Author architectures AA25, T6 ediciones, Escuela Técnica Superior de Arquitectura, Universidad de Navarra, España, 2003.
- [13] ArchDaily. "House in Buzen / Suppose Design Office", Internet: <https://www.archdaily.com/50701/house-in-buzen-suppose-design-office>, Feb. 26, 2010 [Feb. 15, 2022].
- [14] H. Krstic, A. Dib, M. Cvetkovic, "House design: making the composition by decomposing", in Proc. PhiDAC 2019, 2019, pp. 117-123.
- [15] ArchDaily. "Inside Out House / Takeshi HosakaArchitects", Internet: <https://www.archdaily.com/560419/inside-out-takeshi-hosaka>, Nov. 18, 2019 [Feb. 15, 2022].

- [16] H. Krstic, M. Cvetkovic, G. Jovanovic, V. Petrovic, S. Spasic Đorđević, “*Home between the house and the city - architectural concept that uses urban pattern for housing design*”, in Proc. ICUP2018, 2018, pp. 131-139.
- [17] Rory Stott. “AD Classics: White U / Toyo Ito”, Internet: <https://www.archdaily.com/345857/ad-classics-white-u-toyo-ito>, Mar. 20, 2013 [Feb. 15, 2022].
- [18] Elemental living, Phaidon, 2016.



Aleksandar Videnović, University of Belgrade, videnovic.a@gmail.com

Miloš Arandjelović, University of Belgrade, mls.arandjelovic@gmail.com

AESTHETIC CONTRASTS OF CONTEMPORARY URBAN ARCHITECTURE: RARE HIGH ACHIEVEMENTS AND PREVAILING WANDERING

Abstract

The period between the two World Wars was a golden age of the rise of Belgrade and other cities in Serbia. After the Second World War, there was a period of stagnation in urban areas, but there were also high achievements in the field of urban reconstruction. With the social changes that took place in the last two decades of the 20th century, with the advent of transition, the attitude towards the urban renewal of cities in Serbia, especially Belgrade, also changed. These changes brought higher quantity, and lower and lower aesthetic quality of new construction in cities. This possible view of a small part of quality, but also inappropriate architectural - urban practice in the field of urban reconstruction of Belgrade, is accompanied by a picture of the social context in its basic features.

Keywords: Urban renewal, Discontinuity, Architectural achievements, Urbanization process.

ЕСТЕТСКИ КОНТРАСТИ САВРЕМЕНЕ ГРАДСКЕ АРХИТЕКТУРЕ: РЕТКА ВИСОКА ДОСТИГНУЋА И ПРЕОВЛАДАВАЈУЋА ЛУТАЊА

Сажетак

Период између два Светска рата био је златно доба успона Београда и других градова у Србији. После 2. Светског рата у урбаним срединама долази до периода стагнације, али и високих достигнућа у области урбане реконструкције. Са друштвеним променама које су се догодиле у последње две деценије 20. века доласком транзиције, променио се и однос према урбаној обнови градова у Србији, посебно Београда. Ове промене донеле су већи квантитет, а све нижи естетски квалитет новоградње у градовима. Сагледавање малог дела квалитетне, али и неодговарајуће архитектонско – урбанистичке праксе у области урбане реконструкције Београда, праћено је сликом друштвеног контекста у основним обележјима.

Кључне ријечи: Урбана обнова, дисконтинуитет, архитектонски домети, урбанизација.

1. INTRODUCTION

Reasons for interest and selection of this topic should be sought in further elucidation of the circumstances for the consequences of discontinuity of urban development in Serbia on the example of Belgrade, as well as the desired response of the scientific and professional public, through establishing a dialogue on focused issues and possible comparisons in the near or distant environment.

The process of urban development in Serbia experienced serious discontinuities at the end of the 19th century and during the 20th century. Interruptions in development were relatively short but radical during the World Wars. In peacetime, after World War II, urbanization flowed past the old city cores, on new avenues in a socialist-realist manner, encroaching on traditional settlement matrices with less intensity of change. Spatial interventions in the formed tissues of cities were only sporadic, either in devastated areas on the edges of the centers, or within relatively preserved environments, with limited intensity.

In the decades after World War II, the rare new architecture that appeared in the old core of Belgrade followed the dictates of the proclaimed ideology. Later, in the 60s of the last century, there was a liberalization in design, foreign influences penetrated, and production was increasing. In the years to come, in the eighth decade of the 20th century (70s), Belgrade became richer for a series of extraordinary architectural works, especially within the framework of urban reconstruction.

Since 1980, the architectural milieu of Belgrade and other cities has first been gripped by global wandering in search of a new direction in architectural design. In that period, the more or less preserved decency and logic in the development of urban aesthetics were captured by the influences of the quasi-postmodern direction in architecture on the one hand, and the negative influences of transition in social relations in the 90s, on the other. With the transition to the new millennium, in the years that followed after 2000, the new architecture and quality professional skills and resourcefulness of its authors (mainly the Belgrade School of Architecture), successfully coped with the modern practice of development and renewal of cities.

2. TIME OF MOTIVATION AND RATIONALITY

A pictorial description of the architecture of Belgrade in the years after World War II was given by B. Stojanović: "Another beginning in the chain of beginnings within the violent discontinuity of material - cultural development of this city in its long history." [1] It can be stated purity, honesty and integrity in the expressions of architecture of this time. A certain dose of asceticism in the materialization and content of buildings was a reflection of the post-war material poverty of society. Nevertheless, the authors relied on the aesthetics of the pre-war years and created rational modernist structures, with skillful studiousness in finding measure and proportion.



Figure 1. Architecture of Belgrade in the 6th decade of the 20th century (from left to right): 1-Business building, 1956, arch. A. Brkić, 2-Business building, 1958, arch. S. Mihailović, 3-Residential building, 1957, arch. D. Nastić, 4-Resid.-public building, 1958, arch. R. Bogojevic, 5-Residential building, 1959, arch. Z. Petrović [1]

This period is characterized by the absence of wandering and aesthetic failures. The reason should be sought in the required and implied rationality, the limited possibility of creating unnecessary decorations and elements, and relying on previous quality periods of city construction. The period of the dictates of socialist realist construction left crucial traces of modernism in Belgrade, where, in addition to architecture, deprived of emphasized aesthetic values, embodied in workers' settlements and objects of social standard, a kind of pearl of authorial creative architecture was created. (Figure 1)

In this period, investments are treated through the interest of rapid consolidation of social needs, and the endeavors themselves are perceived as a matter of expertise and the privilege of the creative act,

whether it is basic or secondary needs. Awareness of the planned urban renewal of the old city center is still not maturing. Except in negligible traces, there is no incompetence, amateurism, illegal construction and kitsch at this time.

3. TIME OF URBAN RENEWAL AND SUPERIOR ARCHITECTURE

In the seventh and eighth decades of the 20th century, Belgrade continued to develop intensively in a positive direction, bearing in mind all aspects of good architecture, both function and form, and less often but important for the city, growing awareness of the need for urban renewal or urban reconstructions. Thanks to a solid planning basis, based on respect for a wide range of city functions and awareness of the need for multipurpose use of space, interventions of a more delicate nature are being realized, which had not been practiced in Belgrade's architectural practice until then.

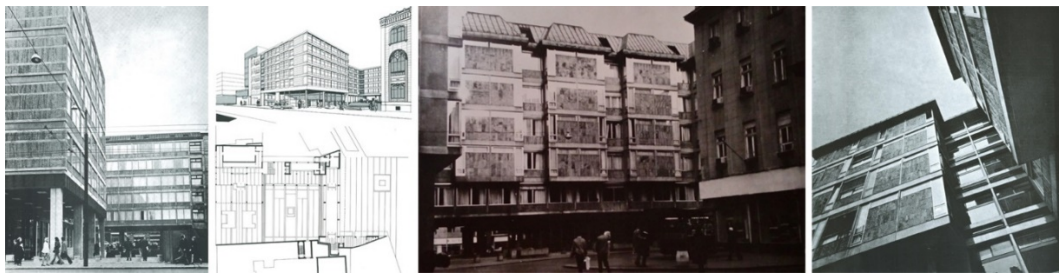

Figure 2. *Successful urban reconstruction, center of Belgrade, Faculty of Philosophy, 1974, Author: arch. S. Ličina [2]*

Several successful urban interventions in the old city center, which, in addition to the main theme, also developed the needs of users of open city contents, nurturing multifunctionality as a need for modern treatment of public space, showed that Belgrade can follow the development of modern centers. (Figure 2) At the same time, the realization of "individual" investments continued, with dedicated, targeted users. Quality in the opening of modern urban architectural themes was the simultaneous education and habituation of the population to higher standards of urban life and the newly set aesthetic and design boundaries below which the city should not be planned in the future. At this time, awareness of the need to create secondary city centers is being established. The architecture of this period also hinted at the first attempts to transpose vernacular sources to modern construction.



Figure 3. *Significant - reference architectural works of Belgrade: Urban Institute (Author: arch. B. Jovin, 1970) (left) and Residential Block (Author: arch. M. Jovanović, 1978) (right) [3]*

The most important architectural works of modern Belgrade were created in the time of "modern" at the beginning of the last century and in the period of the 7th and 8th decades of same 20th century, whether they were small or large themes. (Figure 3) Many of these works can be interpreted as the zenith of modernism, international style, with the predominant use of natural classical materials in construction, in natural concrete (but also facade bricks). Many mistakenly call this architecture "brutalism", and the curators of the exhibition of architecture of the former Yugoslavia at MoMA in New York in 2018, conceived the name of the event using the ambiguity of the word "concrete" in English, combining it with the word "utopia", which is not only inappropriately, but by allusion to futility, it degrades the value and significance of the achieved high artistic level of the presented architecture. [4]

The term and achievements of "Belgrade residential architecture", as well as crucial works of public character were created at this time. As the strength of social realism weakened and the liberalization of society strengthened, the appearance of insolent inappropriate interventions (upgrades, upgrades,

remodeling, conversion) manifested itself, but also clumsy investments, which indicated the coming transitional time and the collapse of aesthetics and logic of city development in the next period.

4. TIME OF TRANSITION AND CHANGE OF VALUE SCALES

The last two decades of the 20th century in the urban development of Belgrade were marked by all the difficulties of changing the social system (transition), as well as the collapse of the federal state in the circumstances of civil war in the immediate vicinity, to be finalized by NATO aggression against Serbia and Belgrade, as its capital. Apart from human sacrifices, many masterpieces of architecture and symbols of the city, created in the same century, also suffered as intentional or collateral targets.

The mentioned circumstances, as well as global trends, have caused a radical disruption of the measure of all values and quality relations on the line: investor - city administration - designer - builder - user. All of the aforementioned inappropriate interventions in space continued and intensified. Apart from the fact that unaesthetic phenomena and habits in spatial action were multiplied, they were also aggressive in their expression, so over time, in many elements, they became the rule of behavior.

The ineffective fight against such phenomena started late, with documents and new decrees and regulations of urban regulation. These new rules did not set the regulation on firm postulates, relying on everything that has proven to be good in the urban development of the city over time, but were prescribed consequently, with the intention of preventing an increased number of inappropriate behaviors in space. Thus, investors, who are by definition greedy in business and blind to aesthetics and art, have accelerated finding new ways of designing without building permits and regulations, in order to achieve as large a building area as possible, or a substantial profit. (Figure 4)



Figure 4. *Fragmentation of form, absence of regulation, excessive exposure, no proportion. New architecture of small value*

To a large extent, there has been a construction of "ready-made architecture", which does not have its ambient foundation and relation to tradition, which can be seen everywhere, which lacks in finding good measures and proportions, and causes a feeling of excessive tendency to expose in inappropriate environments. Such a combination of circumstances significantly violated the ambient values of the traditional parts of Belgrade. Instead of urban reconstruction taking place in larger strokes, the new image of the city is formed as a consequence of small parcelling, cacophony in styles and a pronounced disorder in regulation.

This period also brought the greatest wanderings in search of architectural expression, and the greatest among them is wandering in the fog of the postmodern. Trying to follow that unfortunate, fashionable style of the 80s of the last century, which was essentially never accepted, some architects realized in Belgrade objects that represent illogical volumes of provincial spirit with a bunch of irrationally placed eclectic elements, without foundation in the environment and ambience of a European city.

However, this period also gave rise to essentially high-quality architectural achievements, which, although carrying the difficulties of the time in which they were created, guided by the experience and talent of the author, reached to be quality representatives of one time and a button with modernity. It can be stated that in the 1990s, Belgrade followed the currents of world architecture in individual ups, and this tendency continued in the new millennium. (Figure 5)

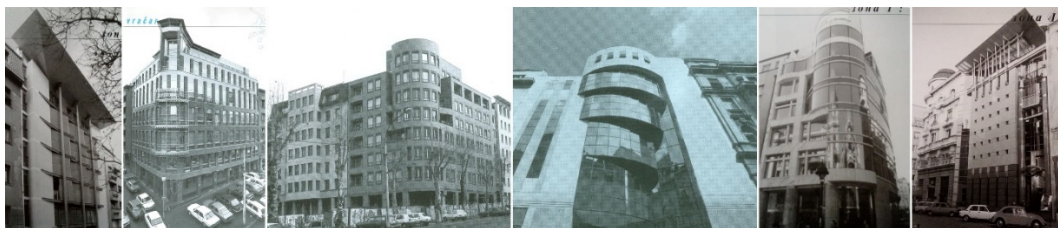

Figure 5. *New rappers at the end of the millennium - quality architectural achievements of the 90's in Belgrade (from left to right): 1-Residential building, 2000, arch. B. Mitrović, 2-Business building, 2001, arch. S. Rogan, 3- Residential block, 1999-2000, arch. M. and Đ. Bobić, M. Lojanica, M. and D. Marušić, S. Ličina, 4- usiness building, 1995, arch. S.Krunić, S. Rajović, 5-Business building, 1994, arch. M. Mirković, 6-Business building, 1997, arch. V. Milunović, B. Mitrović, D. Tešić [3]*

5. TIME OF CONSOLIDATION, SEARCH FOR CONTINUITY AND NEW WANDERINGS

After 2000 until today, the tendencies in the urban development of Belgrade that took place towards the end of the last century, have continued. In the first years of the new millennium, the city repaired the consequences of NATO's destructive aggression in a short time. In the visible ruins, as a testimony to that unfortunate event of several months, only a masterpiece of modern architecture, the Old Army Headquarters of the architect Nikola Dobrović, remains. The city has once again kept pace with modernity.

The appearance of exceptional, authorial achievements continued to the same extent as before, generally viewed as a small share in the total production. There is a calming of differences in styles, or the crystallization of a new approach in quality projects and construction, which could be subsumed under the term new modern or "neo-modern". This is especially noticeable in controlled and professionally - creatively led endeavors on larger interventions and moves, while in the wider city center it is a matter of individual extraordinary creations. (Figure 6)



Figure 6. *Architecture in context (residential buildings in the old ambiances of the city) - respect for the immediate environment by finding a measure in volume relations (Architects: G. Vojvodić, P. Cagić)*

What the city lacks are serious urban reconstructions, especially in the wider center, where small parcelling and interest in capital limit creativity and result in a chaotic overall picture of new structures. Rehabilitation, adaptation and reconstruction of existing contents is becoming more frequent, with the obligatory conversion of space, but also remodeling of facades. (Figure 7–left) This can be considered a positive trend in urban renewal of the city. The arrangement and redefinition of city squares, parks and ambiances is also important, including the installation of a significant number of new and the renovation of existing memorials and fountains.

Another bad tendency can be noticed: the appearance of a series (as from the catalog of standard projects) of new residential buildings built in an eclectic manner with many decorations and appearance from the beginning of the last century, with white facades in artificial stone and many wrought iron elements. These buildings do not belong to the milieu of Belgrade, favor kitsch, and caricature ridicule a city with an enviable tradition, rich history and a solid level of achieved urbanity. (Figure 7–right) The following is also written about the described phenomenon: "Everything that modernists taught with a lot of wisdom - thrift, modesty, honesty, simplicity and "beauty of convenience", and especially the distant coldness, which is often a feature of good art - was abolished by fanfare and false fireworks." [5]



Figure 7. Renovation of facades on the existing three office buildings (Authors: Remorker Architects, 2018-2019) (left) and „Starletarchitecture“ (eclectic manner and bad tendency) (right)

Positive and negative tendencies in the development and urban renewal of Belgrade will reappear. The speed and intensity of their arrival is surprising, creating the impression that entire parts and ambient values of the city disappear overnight and are replaced by new aesthetics. The paradox that arises and warns is the fact that a century ago (then in new directions in architecture and art) Belgrade followed in step with time and the world, building in the style of "modern", and today, in a time of changing values, found in a situation to represent a polygon for the construction of buildings with greatly outdated functional and aesthetic features.

LITERATURE

- [1] Stojanović B., Martinović U. *Belgrade 1945-1975, Urbanism, Architecture*, Technical Book, Belgrade, 1978, 13 p. (on Serbian)
- [2] Brkić A. *Signs in Stone, Serbian Modern Architecture 1930-1980*, Association of Architects of Serbia, Belgrade 1992 (on Serbian)
- [3] Milašinović Marić D., *Guide to modern architecture in Belgrade*, Association of Belgrade Architects, Београд, 2002. (on Serbian and English)
- [4] *MoMA Exhibition, Toward a Concrete Utopia, Architecture in Yugoslavia, 1948-1980*, Museum of Modern Art, New York, Jul 15, 2018/Jan 13, 2018.
- [5] Bogunović S. *Starletarchitecture, Reading the City*, Culture Art, Science, Politika Daily, February, 2016, 4 p. (on Serbian)
- [6] Rajović S. *Architecture 33 competition projects, Architect Slobodan Mića Rajović*, Grafiprof, Belgrade, 2011. (on Serbian)
- [7] *Portraits of Architects - Retrospective of Members of the Architectural Section - Ulupuds 1953-2010*. Vizuelno, Belgrade. 2010. (on Serbian and English)
- [8] Videnović, A., Arandelović, M. *City discontinuity - Traditional urban structures Redefining*, University of Belgrade - Faculty of Architecture, Belgrade, 2020. (on Serbian)
- [9] *Register of modern Architecture and Urbanism in Serbia 1945-1990*, Society of Architects of Belgrade – Docomomo Serbian, Belgrade, 2018. (on Serbian)
- [10] Milić, A., V. *ArchiTEXTure -Essays on Architecture*, Matica Srpska, Novi Sad, 1992. (on Serbian)
- [11] Foster, H. *The Return of the Real*, Orion Art, Belgrade, 2012. (on Serbian)
- [12] Friedmann, J. *The World City Hypothesis*, Development and Change, vol. 17, 1986.
- [13] Kofman, E., Lebas, E. (eds.) *Writing on Cities*, Oxford: Blackwell, 2000.
- [14] Mendieta, E. *A Phenomenology of the Global City, Philosophy and the City*, State University of New York, New York, 2008.
- [15] Petrović, M. *Globalization and cities*, Sociology, Vol. XLVI, no. 1, Belgrade, 2004. (on Serbian)
- [16] Bullen, P., Love, P. *Factors influencing the adaptive re-use of buildings*, Journal of Engineering, Design and Technology no. 9, 2011.
- [17] Milenković, A. *Architecture evaluation horizons*, Naučna knjiga, Belgrade, 1988. (on Serbian)
- [18] Jevtić, H., M. *Critical reflexes - 101 reviews of contemporary Serbian architecture*, NIN, Belgrade, 2004. (on Serbian)
- [19] Putnik, Prica, V. *Residential architecture of Belgrade 1918-1941*. Institute for the Protection of Cultural Monuments, Belgrade, 2021. (on Serbian)



Jovana Vukanić, University of Belgrade, jovanavukanic96@gmail.com

ANALYSIS OF REVITALIZATION AND CONVERSION OF CULTURAL AND HISTORICAL SITES ON THE EXAMPLE OF RENZO PIANO BUILDING WORKSHOP-PATHE FOUNDATION

Abstract

Designing and building a new building in a historic city block is connecting modern and contemporary architecture with existing historically significant buildings. The Pathe Foundation of the Renzo Piano Building Workshop design team is located in Paris, France. The subject of research of this paper would refer to the analysis of revitalization and conversion of cultural and historical objects. The aim of this paper is to use a detailed analysis of the origin and development of all buildings on the site to indicate the ability of designers that their architectural building can get a good aesthetic solution that fits into the environment and does not disturb the cultural and historical significance of previous and existing buildings.

Keywords: Renzo Piano, Pathe Foundation, preservation, conversion, cultural heritage, glass.

АНАЛИЗА РЕВИТАЛИЗАЦИЈЕ И КОНВЕРЗИЈЕ КУЛТУРНО-ИСТОРИЈСКОГ НАСЛЕЂА НА ПРИМЕРУ ПРОЈЕКТАНСКОГ ТИМА RENZO PIANO WORKSHOP-PATHE FOUNDATION

Сажетак

Пројектовање и изградња нове зграде у историјски градски блок јесте повезивање модерне и савремене архитектуре са постојећим историјски значајним објектима. Пате фондација пројектантског тима Рензо Пиано Буидинг Воркшоп налази се у Паризу у Француској. Предмет истраживања овог рада би се односио на анализу ревитализације и конверзије културно историјских објеката. Циљ рада је да се помоћу детаљне анализе настанка и развоја свих објеката на локацији укаже на способност пројектаната да њихово архитектонско здање може да добије добро естетско решење које се уклапа у окружење и не нарушава културни и историјски значај претходних и постојећих објеката.

Кључне ријечи: Renzo Piano, Pathe Foundation, очување, конверзија, културно наслеђе, стакло.

1. INTRODUCTION

The design of the building for the Pathe Foundation by architect Renzo Piano combines the preservation of the demolition and the new building in same time. The Jerome Seidou Foundation was once the largest film equipment and production company in the world, and now serves as an organization to promote the history and heritage of film and Pathe. The curved form of the building, lined with glass and perforated panels is hidden from view behind the historically significant facade, but protrudes above it, announcing its presence. And if the eggshaped structure seems to be squeezed between the surrounding buildings, ready to burst, it actually has enough space to breathe to allow even the neighbors enough daylight and ventilation. The foundation's new program includes showrooms, a 70-seat film screening room, Pathe Foundation offices and an archive.

2. OBJECT ANALYSIS

2.1. HISTORICAL REVIEW

The foundation was founded in 2006 with the aim of creating a center in Paris that will promote cinematography with the help of the historical collection of the company for the production and distribution of film equipment, which was founded by the Pathe brothers in 1886. The building of the cinema was chosen as the new headquarters of the foundation, where the Gobelins Theater used to be, with a cult facade that has been preserved to this day, which can be seen in Figure 1 (Figure 1). The facade on Gobelins Avenue has been restored and preserved due to its historical and artistic value. There are sculptures on it, a man representing a drama and a woman representing a comedy, by the famous sculptor Auguste Rodin, which is why it is considered a cult building in the Gobelins area.



Figure 1. *Pathe Foundation, Renzo Piano, Paris, France: Gobelins Theater Façade*

2.2. TYPE OF INTERVENTION

The project required the demolition of two existing buildings in order to create an architectural form of organic shape that corresponds to the location and its limitations. The designers did their best to respond to the functional and representative program requested by the Foundation, as well as to make the space surrounding the building better and more functional. The foundation is conceived as a multidisciplinary space dedicated to the film industry that meets all the needs of visitors. Within the building there are rooms for silent film, exhibition spaces with the heritage of the center for research and documentation, as well as rooms for various workshops and trainings. (1)

2.3. THE CONCEPT OF THE REVITALIZATION SOLUTION

From an architectural point of view, two aspects especially characterize this Piano design. The first important thing is the way the architect dealt with the problem of natural light, since the foundation's

headquarters is almost completely closed to other buildings, which can be seen in Figure 2 and is located in one of the inner courtyards of the Gobelins area (Figure 2). The distance from the neighboring buildings did not allow openings on the facades of the newly designed building, so the architect found a solution in a domed transparent roof over which the last two floors with offices and a library are naturally lit, so natural lighting is necessary. The remaining three levels above the ground where the permanent exhibition is located in the exhibition gallery, warehouses and archives do not require natural lighting, so the condition that the facades do not have openings is met. (2)



Figure 2. *Pathe Foundation, Renzo Piano, Paris, France: Location of the building on the plot (2)*

Another fascinating thing is how the designer managed to design the smallest possible foundations of the building with a satisfactory shape, forming a buffer zone between the existing buildings and the newly designed building, so as not to disturb the intrusion of natural light and ventilation of existing buildings surrounding the yard (Figure 3). This facility causes delight and surprise among visitors when they see an amazing building inside the courtyard that is almost invisible from the street. The new transparent façade immediately behind the restored façade represents the main public entrance to the foundation (Figure 4). This so-called greenhouse offers a direct view of the inner courtyard. In this case, the formation of such a facility is solely the result of location conditions. The distance from the neighboring buildings, access to the plot and other location conditions were well analyzed, everything was respected so as to create a more than pleasant ambience that is naturally well lit and ventilated. Seen from the street, a discreet light can be seen through the retained and renovated facade of the foundation's buildings, and in the evening light penetrates.



Figure 3. *Pathe Foundation, Renzo Piano, Paris, France: The relation of newly designed with the existing buildings (2)*



Figure 4. *Pathe Foundation, Renzo Piano, Paris, France: Main public entrance to the Foundation (1)*

2.4. THE CONCEPT OF SPATIAL SOLUTION OF THE OBJECT

Architect Renzo Piano is behind the project of the new headquarters of the Jerome Seidouk-Pathe Foundation. He designed a five-story shell-like building with 7000 protective sunshades and an unusual way of using the material. In addition to the outer glass cladding, the interior of the building is treated with a combination of wood and steel (Figure 5).



Figure 5. *Pathe Foundation, Renzo Piano, Paris, France: Combination of wood and steel in interior (8)*

This rounded building of 2200m² is integrated into an inner courtyard surrounded by several Parisian buildings in the Gobelins area. On the first level there is a permanent exhibition dedicated to the history of cinema. At the second level of the foundation, some of the first cameras are on display. A total of 200 pieces of cinematographic equipment that follows the development of the apparatus that Pathe sold from 1897 to the 1980s (Figure 6). The foundation's collection also includes footage and photographs taken on sets and filming.

The marketing collection contains printed archives, film scripts, theater programs. Exhibited on two floors, these temporary exhibitions will serve as an illustration of different film cycles and allow visitors to discover a specific age, theme or director (Figure 7). (3)



Figure 6. *Pathe Foundation, Renzo Piano, Paris, France: Exhibition item (2)*



Figure 7. *Pathe Foundation, Renzo Piano, Paris, France: Archive (2)*

This architectural work is a great example of how an avant-garde building is inserted into the historical environment, many call it an organic work and compare it to an armadillo and it is considered one of the best Piano buildings.

2.5. THE CONCEPT OF A FUNCTIONAL SOLUTION OF THE OBJECT

As already mentioned, the ground floor of the building was formed inside a block of buildings in the Gobelins area of Paris. It is of the transit type, it is possible to pass through the ground floor from one side of the location and exit to the other side and the other street. At the back of the location, connected to the ground floor, there is a garden with birches visible through a glass wall (Figure 8).

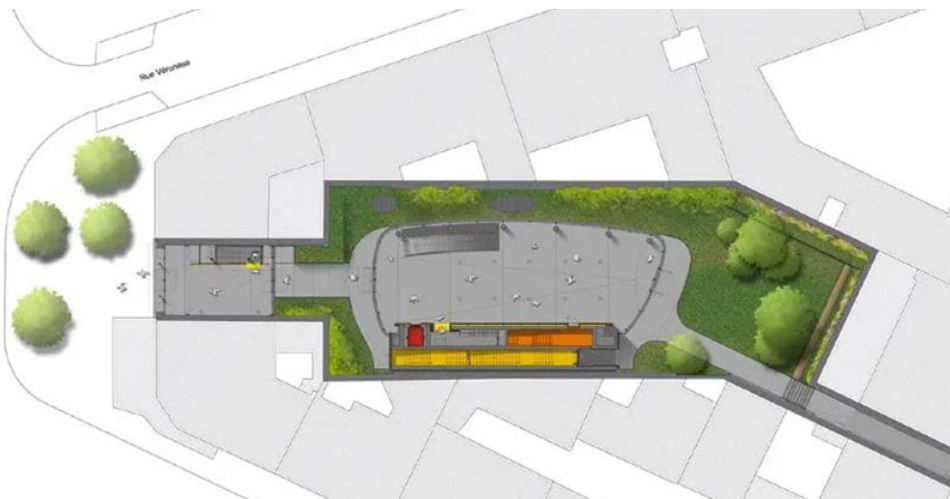

Figure 8. *Pathe Foundation, Renzo Piano, Paris, France: Ground Floor (2)*

The space between the cult facade and the new building is used as a point of sale for cinema tickets in the basement available to the public. The rectangular shape of that passage is the only orthogonal shape in the base of the building, functionally used to accommodate the external fire escapes. Stairs from the ground floor lead to the basement, where there is a hall for showing silent films with seventy seats (Figure 9) as well as an exhibition gallery that exhibits changing settings, such as the exhibition of film posters from the beginning of the twentieth century. [4]

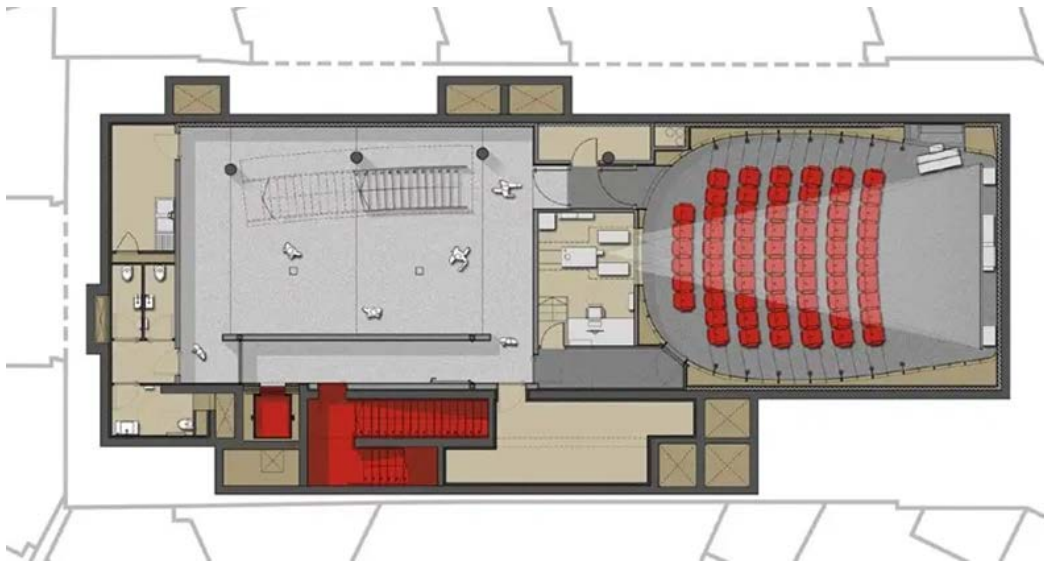

Figure 9. *Pathe Foundation, Renzo Piano, Paris, France: Basement Foundation (1)*

Figure 10 shows another gallery on the first floor, where film cameras and projectors are exhibited, placed on a long platform without protective glass, so as such the whole exhibition looks like a modern sculpture.



Figure 10. *Pathe Foundation, Renzo Piano, Paris, France: First Floor Foundation (1)*

A small location with great limitations gave birth to a great object, which gives the conclusion that necessity is the mother of invention. The most transparent area of the building is the research center on the fifth floor, shown in Figure 11, located in a vault with 32 parabolic arches made of glued laminated wood spanning over 15 meters (Figure 11.).

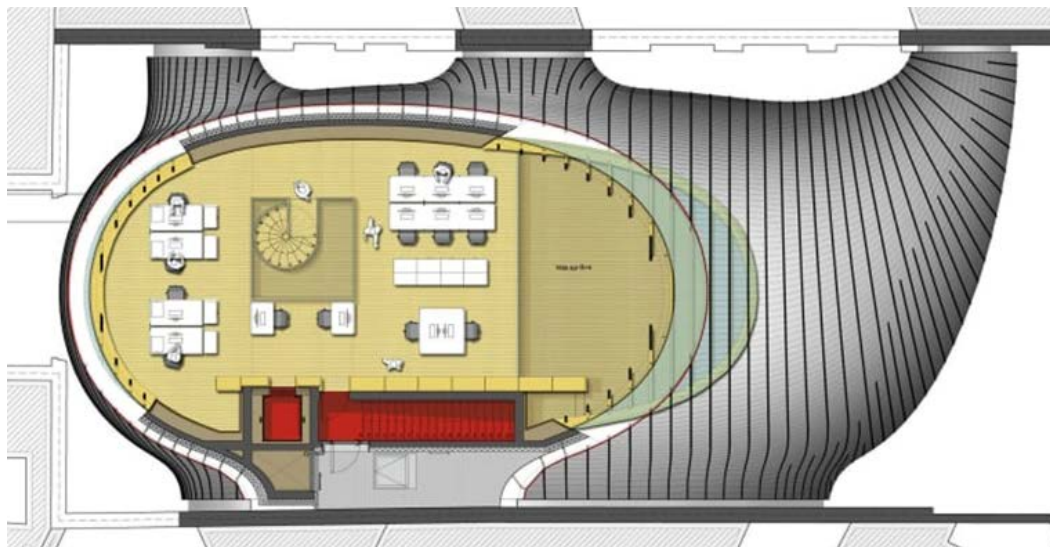

Figure 11. *Pathe Foundation, Renzo Piano, Paris, France: Fifth Floor Foundation (10)*

The design team chose the construction of laminated larch, both because of its appearance and beautiful effect in the interior, given that the construction is visible, and because of its flexibility. An interesting thing about how dedicated the team was in making this work and how much attention was paid to the smallest details is that the designer Sahlman went to a factory for the production of this wood in Italy and inspected and approved each bow before it was transported to the location. Due to the limitations on the location, the largest arches had to be delivered in two parts, so they were connected on the spot with steel screws and plates. One of the details of the construction is shown in Figure 12 (Figure 12). The arches are tied in a steel gutter, which runs along the perimeter of the building, because they could not directly rely on the concrete shell that goes from the second to the fourth floor.

The glass shell, which consists of double-curved glass, creates a domed roof opening 30 meters long. Seven thousand curved aluminum plates or slats form the outer cladding over the glazing as well as the rest of the concrete structure and function as protection from the sun and from neighbors. [5] In the vertical section shown in Figure 13. The arrangement of functions by floors can be best seen, which has already been discussed. Two basement floors of orthogonal shape, intended for visitors, and the ground floor where you can see through the glazed part of the garden in the back of the location, above are three floors where you can see that they have no window openings, and the last two integrated with the construction create a magical interior and special you experience a play of light penetrating an object.

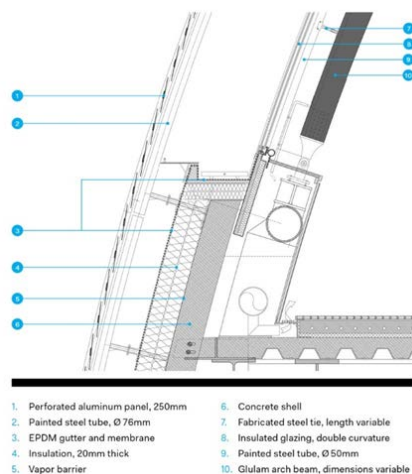

Figure 12. *Pathe Foundation, Renzo Piano, Paris, France: Construction Detail (7)*



Figure 13. *Pathe Foundation, Renzo Piano, Paris, France: Vertical cross section (3)*

With this project, the neighbors from the buildings that got more natural light and a better view from the windows around the perimeter of the location, are no longer looking at the windows of the six-storey building that used to be there. The designers were guided by which spaces they had to leave open, thus connecting directions, creating a concept and establishing that the shape of the building must be rounded, with arched girders and construction so that all neighbors have enough light and no one's comfort is disturbed. The intrusion of the sun's rays and exactly which parts are open can be seen in the longitudinal vertical section (Figure 14.).

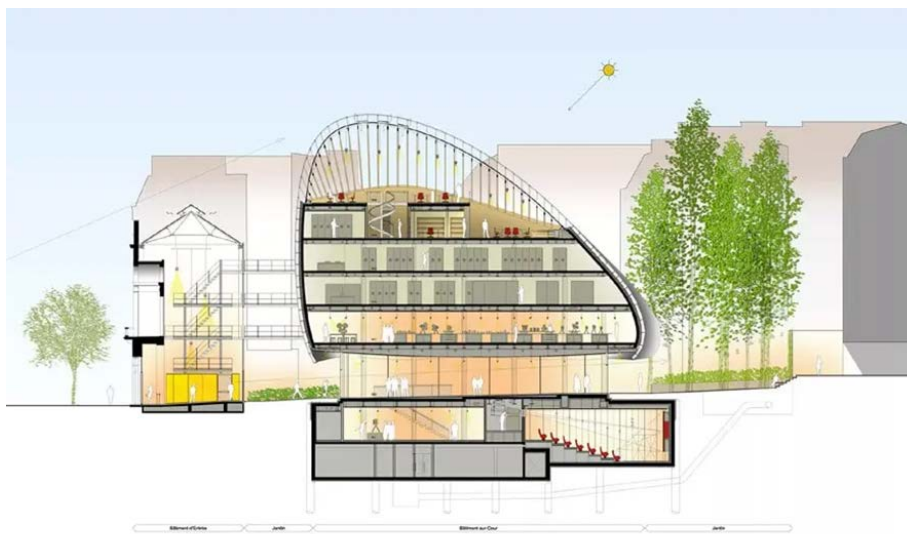

Figure 14. *Pathe Foundation, Renzo Piano, Paris, France: Longitudinal vertical section (3)*

The entire building is covered with a perforated aluminum casing, hiding the transition from the upper glazed layer of the building to the full concrete part. The transparency of the perforation is not the same everywhere, it is 30% to the south and 50% to the north, in order to establish a good balance of light penetration in the summer and winter months. [7]

3. CONCLUSION

The building, which features a long glass vault, covered with perforated aluminum panels of organic shape that compare to an armadillo, has the title of one of Piano's best works. The highest point of the building is concentrated approximately in the center of the location, where it rises to five floors, and then dramatically descends to the ends, keeping a view of the neighbor and access to daylight, while seeming almost invisible from the streets. This five-storey building is characterized by a sleek design of bold shapes, excellent interior design, the way in which the arched transparent roof lets in natural light in the building, as well as the overall shape of the building.

The applied research showed that the development of the conceptual architectural and urban design of the building is reflected in the solution of the urban functional and design concept as well as in the selection of adequate materials. The location, planned content and principles of work will be significantly used for the design of such facilities. The location on which the facility was built dictated the conditions of construction and analysis of the environment, and the importance of the neighboring buildings influenced the design and selection of applied materials.

Today, such facilities have become responsible for a wider audience and wider public access, so their availability is achieved through the field of entertainment, business, tourism and the economic market.

LITERATURE

- [1] www.archello.com
- [2] www.inexhibit.com
- [3] www.archdaily.com
- [4] www.nybooks.com
- [5] www.architectmagazine.com
- [6] www.architizer.com
- [7] www.architectureau.com
- [8] www.pinterest.com
- [9] www.google.com
- [10] www.divisare.com

66

Professional paper | Стручни рад
DOI 10.7251/STP2215668P
ISSN 2566-4484



Charikleia Pagouni, National Technical University of Athens, chara.pag@gmail.com
Nenad Nikolić, University of Priština - Kosovska Mitrovica, nenad.nikolic@pr.ac.rs
Thanos Iliodromitis, University of West Attica, ailiodro@gmail.com
Vassilis Pagounis, University of West Attica, pagounis@uniwa.gr
Saja Kosanović, University of Priština - Kosovska Mitrovica, saja.kosanovic@pr.ac.rs
Maria Tsakiri, University of Athens, mtsakiri@mail.ntua.gr

GEOMATIC DATA FOR HISTORIC BUILDINGS. THE CASE STUDY OF THE CATHOLIC CHURCH OF ST. LUKE IN ATHENS, GREECE

Abstract

The application of contemporary methods, tools and the equipment to produce technical documentation for heritage buildings is a cuttingedge topic that brings together engineers from various fields of technical sciences. Focusing on one specific heritage example, that is the church of St. Luke in Athens, this paper explains entire methodological process of generating the data on physical characteristics of architectural objects by combining several geo-spatial methods and techniques. The final product is the spatial model of church building, formed from generated point cloud. The model represents a basis from which different forms of technical documentation can be produced, from layouts and elevations, to sections, to details, to 3D representations.

Keywords: heritage buildings, geo-spatial methods, BIM, technical documentation.

ГЕОМАТСКИ ПОДАЦИ ЗА ОБЈЕКТЕ ОД ИСТОРИЈСКОГ ЗНАЧАЈА. СТУДИЈА СЛУЧАЈА КАТОЛИЧКЕ ЦРКВЕ СВ. ЛУКЕ У АТИНИ, ГРЧКА

Сажетак

Примена савремених метода, алата и опреме у сврху израде техничке документације за објекте који припадају градитељском наслеђу је актуелна тема која окупља инжењере из различитих области техничких наука. У овом раду је на примеру цркве Св. Луке у Атини објашњен целокупан процес генерисања података о физичким карактеристикама архитектонских објеката, комбиновањем више гео-просторних метода и техника. Затим је из генерисаног облака тачака формиран просторни модел објекта цркве. Тиме је успостављена основа са које се даље могу генерисати различите форме техничке документације, од основа, пресека, изгледа, детаља, до 3Д приказа.

Кључне ријечи: градитељско наслеђе, гео-просторне методе, БИМ, техничка документација.

1. INTRODUCTION

In contemporary concepts such as smart or the virtual city, the three-dimensional (3D) models of built structures play an important role. Geomatics techniques come to the fore in creating such models. The three-dimensional mapping techniques like photogrammetry, terrestrial and Unmanned Aerial Vehicle (UAV) / drone photogrammetry, or the terrestrial and aerial laser scanning, all enable efficient data acquisition. The application of mentioned techniques leads to the generation of point clouds, i.e., the 3D documentation of processed physical structures.

One common approach to generate 3D building models is to combine footprint data with the data collected by airborne laser scanning (ALS) for roof structures as well as the terrestrial laser scanning (TLS) for façades [1-3]. However, the ALS does not have the accuracy of TLS technology that remains the main data source for an exact 3D building model, e.g., [4-6]. In addition, the drone photogrammetry has gained much popularity due to the ease of use and the cost effectiveness in mapping sites and structures, all of which can successfully be achieved with a low-altitude image-based survey, e.g., [7-9]. In any case, the mapping of areas and the buildings requires a lot of human resources and a large amount of time. A community-based mapping or a participatory mapping method may be options to facilitate a 3D digitization process and support smart cities, especially when it comes to the built heritage assets, e.g., [10].

Heritage is almost always related to the concept of a territory, as both a geographical and a cultural entity. Heritage is also related to the social and community organizations that nowadays are often formalized as territorial administrative units. Being a collective property, heritage tells the history - of people or a territory - that is passed on from one generation to the next. Through the heritage, the features of communities and the territories gain timelessness and the distinctive character, thus representing the base of construction of a common cultural identity. One continuous task, therefore, is to keep recognizing those material and immaterial elements that are attached to a certain territory and its social environment as key components of cultural identification.

One such identified example is the Catholic church of St. Luke built in the middle of the 19th century in a newly formed settlement Heraklion in Athens. Spatial and socio-cultural development of Heraklion (Figure 1) over time was steady. Nowadays, this neighborhood represents a thriving suburb of Athens located about 7 km from the city center. In parallel, the church of St. Luke underwent a number of changes throughout its history, but to this day it remains a valuable example of sacred architecture that as such will be studied in this paper.



Figure 1. *Life in Heraklion over the course of the 20th century. Left: Year 1900. Middle: 1923 - The feast of Saint Luke (with photographed car of Otto Fix). Right: Heraklion in 1957. [11]*

The work carried out represents one part of a greater plan to establish the key aspects of local cultural identity of Heraklion. The study focuses on production of digital documentation record of the church of St. Luke, using a variety of geospatial techniques. Digital management of heritage buildings can be successfully achieved through the BIM (Building Information Modelling / Management) models. For historical buildings, BIM can be referred to as HBOM (Historical Building Object Modelling) [12], or hBIM (historical or heritage BIM). In geodetic and architectural surveying, BIM model is commonly displayed in a flexible form that allows to introduce physical changes in time, and to add different physical details. Such a model is proven to be very useful for heritage buildings, too, as it allows accumulating different types of data in one single database. Whilst the work regarding hBIM methodology has already been published, there still is a need to carry out researches that will provide an understanding of the potential of BIM for heritage buildings.

Relevant literature on hBIM is addressing several issues such as input data quality and the quantity, e.g., [13, 14]. Besides the geometrical content, the type of data texture is also important. Texture can present the information concerning age, material type, etc., but does not necessarily need to be realistic, because it can be created from other data sources like infrared images, e.g., [15]. The

texture can be provided by BIM software, or created in a customized way based on the images of a subject structure.

The paper is structured in four sections. Section 2 describes history and the architecture of selected case study that is the St. Luke church, and explains used geomatics methods and techniques, and the data field operations. Section 3 describes data processing of point clouds, and the development of 3D model to be imported to the BIM. Finally, Section 4 discusses practical application of produced results, and provides the concluding remarks.

2. MATERIAL AND METHODS

2.1. ST. LUKE CHURCH IN ATHENS

Dozens of Bavarians came to Athens with King Otto in 1832 and subsequently founded Heraklion (Arakli) settlement. The center of the settlement was so-called Old Heraklion, better known among locals as Germanochori (Eng. German village). The legend says that Otto looked for an area for his country house and the settlement for families of his entourages. To select an optimal location, Otto ordered his courtiers to slaughter lambs and hang them on trees in various parts of Attica. He would choose the place where the lambs would rot later, since there would be less humidity and generally a better climate. Eventually, the lambs rotted with a longest delay in today's Othonos Square in Old Heraklion. Thus, in 1837, Otto founded - with his first commander Christopher Nezer - the Bavarian Military Colony of Heraklion. About 33 persons, courtiers and mercenaries, so settled at the place that represents the yeast of today's Heraklion community. According to the 1838 census, Heraklion had 42 inhabitants, majority of which were the Catholics [18]. For spiritual needs of inhabitants, the priest of the Palace, Fr. Arneth, ascended to Arakli at that time, suggesting construction of a holy temple with the Evangelist Luke as patron.

The history of St. Luke church in Heraklion (Figure 2) can be observed through three phases of spatial expansion of the temple building (Figure 3), as well as through the critical damages, i.e., the extensive renewal works.



Figure 2. Location of the church of St. Luke. Left: Position in the City of Athens. Right: 3D presentation of Heraklion with the St. Luke church in the center. [16, 17]

The initial church project was developed in 1840, and the construction marked by ceremonial blessing of foundations began in 1842. The design features several architectural elements typical of the work of Danish designer Hans Christian Hansen who at that time was the most prominent architect and planner in Athens. Hansen's idea was to build a small temple with rectangular plan and the basic Gothic-style elements. The roof of the church is saddle-like. The base was 17,45 meters long.

Light-colored wooden ceiling that covers the nave is divided into aisles by septa, whose coffers - 105 in number - are ornamented with yellow patterns. Thirty sigmoid wooden jewels adorn the side walls. The roof, as well as all interior and exterior decoration of the church, was constructed by Joseph Martinellis. The entrance was crowned by lobed glass. Narrow and high window openings finish with a zigzagged line at the top. Two middle windows were added later. The triumphal arch is also zigzagged. Above the main steps is the icon of the Evangelist Luke. On each side of the apse are two altars, to the right of the Virgin Mary and to the left of the Sacred Heart of Jesus. The construction was completed in 1845, and the inauguration took place on the 18th of October the same year [19].

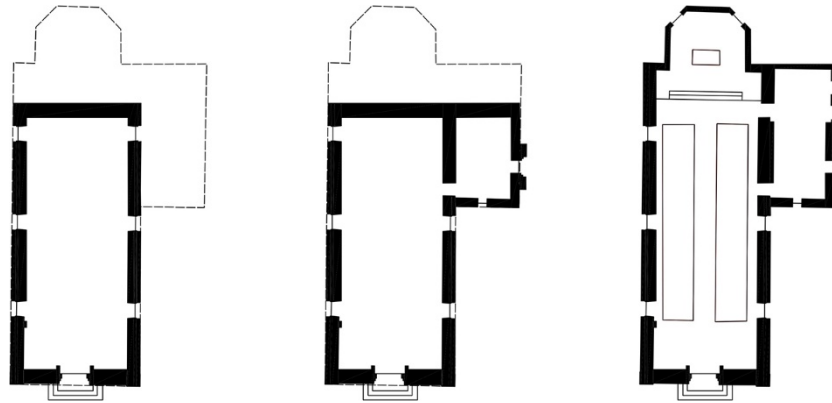

Figure 3. Three phases of spatial expansion of St. Luke church building. Left: Period 1845-1900. Middle: 1900-1972. Right: 1972-today. [Authors]

On May the 8th, 1847, lightning hit the St. Luke temple and destroyed one part of its spire, up to the roof, consequently breaking panes and the sanctuary. After more than half of century, at the beginning of 1900, architect Max Schultze initiated the renovation of damaged church. Present vestry and the spire originate from this period. Although the church was in bad conditions for a long period of time, its significance was not lost. This can be witnessed by the Kaupert's map from 1878 where the St. Luke church was shown probably for the first time. Namely, German topographer Johann August Kaupert, famous for land-surveying in Athens and the work "Atlas of Athens", represented the whole Attica in 1:25000 scale maps. In the specific map (Figure 4), one can see the St. Luke church (Kirche is the German word for church) with a few nearby houses. The village Heraklion continued to grow and subsequently became incorporated into urban area of Athens. Urban map from 1936 (Figure 5) shows the church and the adjacent buildings.

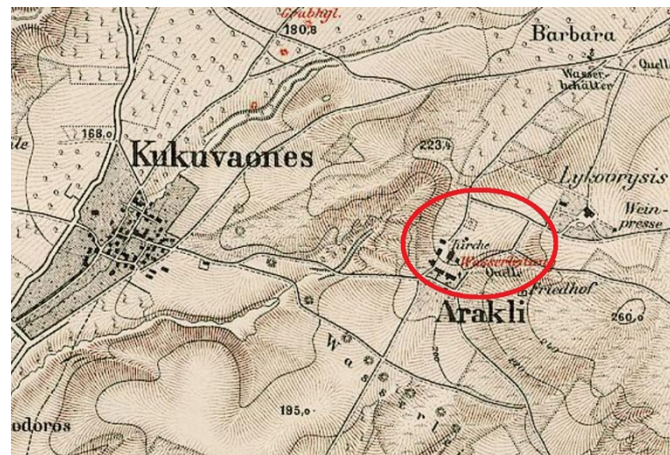

Figure 4. Kaupert's map with marked church of St. Luke, 1878 [20]



Figure 5. Urban plan of Heraklion, 1936 [21]

During extensive church repair in 1931, two marble inscriptions were built inside, from both sides of the entrance [22]. In 1950, the entrance door of the church was renewed, the new, larger bell named Hope mounted (Figure 6), and the facades were painted.



Figure 6. The bell Hope installed at the St. Luke church in 1950 [23]

The last sizable reconstruction of the St. Luke church building was initiated in 1965 and completed in 1972, under supervision of the Reverend Nicholas Vidalis. Introduced changes correspond to the spatial expansion of the temple (Figures 3, 7, 8). Namely, church building was extended in length to the side of the sanctuary. Next to that, several existing temple elements, such as the catechism room, priest's room, and the meeting room, were demolished and again rebuilt to improve overall structural and the aesthetic quality [22].

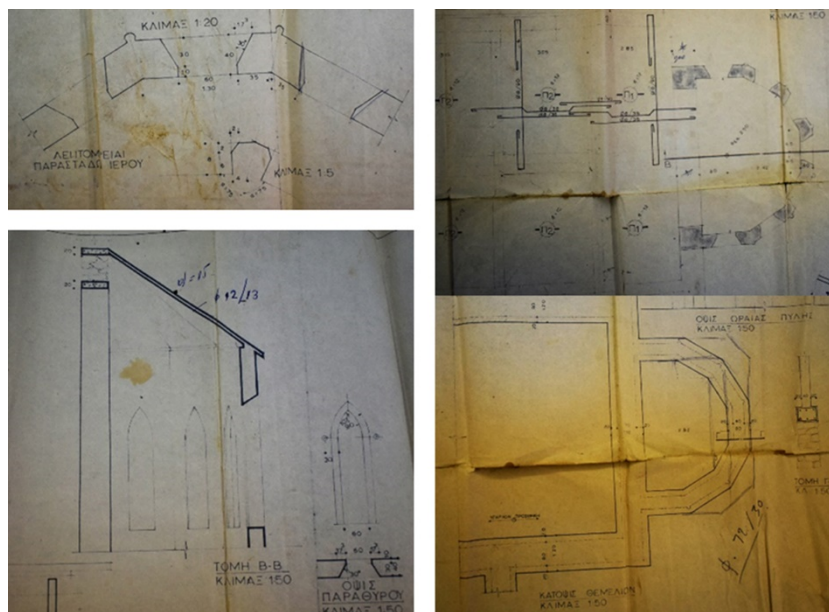

Figure 7. Drawings for spatial extension of the St. Luke church, 1970 [23]



Figure 8. Construction works at the St. Luke church in 1972 [23]

On the two columns at the church front, from both sides of the spire, two statuettes were placed, one of the Apostle Peter and another of the Apostle Paul, just as the architect Theophilus Hansen originally planned (Figure 9). Next to the works on the church building, the new presbytery was constructed, based on the project of Dimitris Sarros (Figure 10). Furthermore, Reverend don Vidalis

enriched the interior of temple with five large and three small reliquaries with bones of Christian “protomartyrs” originating from the Holy Church of St. Mark in Zakynthos, earlier destroyed in earthquake. The reliquaries bore old lead seals and illegible Latin inscriptions. For these sacred relics, wooden carved display cases of 1.85 m width and 2.15 m height were ordered. The showcases of Gothic style were crafted by woodcarver Efstathios Gaitanopoulos.

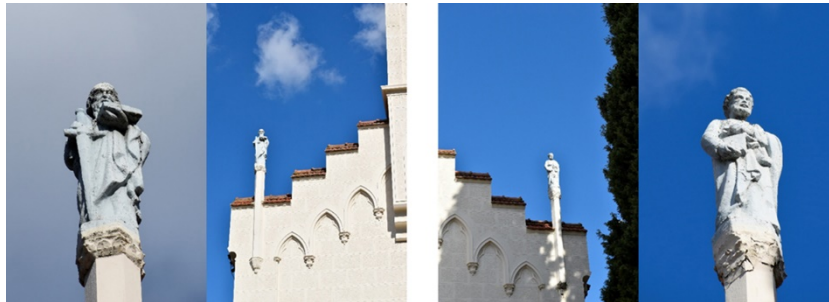

Figure 9. Statuettes of the Apostles Peter and Paul at the church front [Photos by authors]



Figure 10. Old and new presbytery next to the St. Luke church [23]

Parallel to the works on the church building, its immediate surrounding was changed as well. In 1968, the copper bust of King Otto was erected in church garden. The unveiling took place on the 16th of June, at the occasion of the 100th anniversary of his death. The bust was created by Georgios Maltezos, the well-known writer of the “Heraklion Chronicle”. Reimbursement of costs for melting the copper was offered by Paola Huber from Ellwangeu/Jagst, Germany, in memory of her father Maximilian who grew up in Heraklion. Other expenses were handled by the Church. This way, the descendants of Bavarians in the old military colony wanted to honor the founder of their settlement after 130 years.

The church of St. Luke is surrounded by the old Pine Park. In one of its corners, there is the Gothic-style column designed by sculptor Nick Georgantis. The column is fully aesthetically harmonized with the St. Luke church and the whole environment. To the right of the entrance to the park, there is a pilgrimage hall with an inscription. An inscription is also built into the left wall of the park, which belongs to the municipality of Heraklion. East of the church of St. Luke, and at a distance of about three hundred yards, the Cemetery of the Catholics of Old Heraklion extends on a hill. This cemetery is one of the most well-preserved monuments. The cemetery of the Orthodox inhabitants of Old Heraklion is located right next to that of Catholics since 1936. Among the many sepulchers, the Fix family tomb in the middle of the Orthodox cemetery is distinguishing.

2.2. METHODOLOGY

Geometric documentation of structures like churches presents certain difficulties due to large height differences, abundant surface details, or the existence of hidden surfaces. Therefore, the synergy of data is essential to significantly increase the amount of geospatial information and to obtain more accurate results from the documentation process. To date, 3-dimensional (3D) high detailed visualization products are easily available, which convey the accuracy of original data. In this work, the combination of laser scanner data with geodetic reference provided by GPS measurements (38° 03'34.94421"N 23° 46'21.49187"E 220.825) was implemented.

For complete church recording, the capture of twenty-seven scans was performed around the perimeter of the building (Figure 11), and inside (Figure 12). Leica Geosystems Blk360 laser scanner was used for scanning. The distances between the scanner and the object were less than 20 m. Scan overlap during data capture was between 40-60%.



Figure 11. *Point cloud externally capturing the church building [Authors]*



Figure 12. *Laser scanning process for capturing the church structure from inside [Authors]*

A custom-made mount was used during the capture of twenty scans so that the scanner could be mounted on a tripod and leveled. The acquired scans were directly referenced in the state reference system (namely EGSA87) using GNSS surveying. To calculate external accuracy of merged point cloud, the special targets (Figure 13) measured by using Leica Geosystems TCR1202 + total station (quoted precision of 2 " and 1mm + -2ppm) were used.

Due to occlusion during the scanning survey, and the difficulty to find suitable locations and set-up the scanner to have direct visibility of the roof, it was decided to use digital imagery taken from the drone and achieve the full building coverage that way. The model DJI Mavic Mini was used in that purpose. It is a light, compact and easy-to-use drone with a 12MP camera, suitable for close-range flights and applications. In total, 41 shot were made, from them 15 being vertical just above the church, and the rest were side shots with the angles from 30o-60o (Figure 14). The vertical shots were made from a height of 40 m above the ground. All of the images have an overlap of at least

40%. No flight planning software was used as it was quite easy to calculate the overlaps due to the small size of the church building.

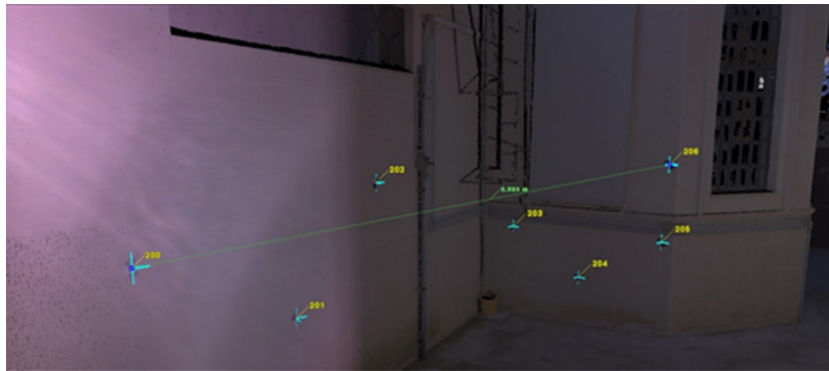

Figure 13. Tie points as seen in point clouds [Authors]

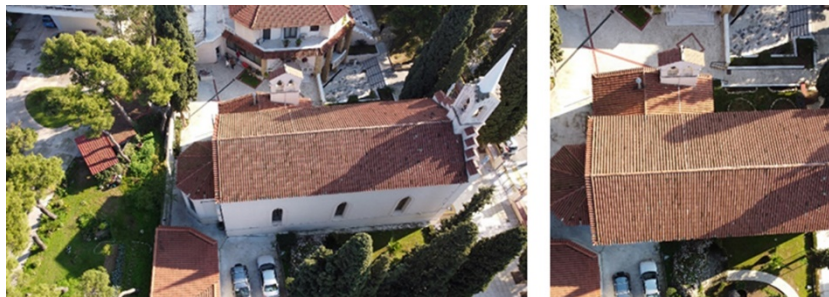

Figure 14. Side and vertical drone capture [Authors]

The proprietary software Agisoft Photoscan was used to process obtained images. All produced images were added to the model, but finally 35 of them were used. Following the alignment and the optimization of images, the sparse and the dense cloud were produced. Figure 15 depicts one detail of the dense cloud from the roof of the church. The dense cloud has an average density of 27.6 points/cm². Moreover, the model was georeferenced by using control points, so that the exported point cloud can be combined with the point cloud that was produced by using laser scanner.

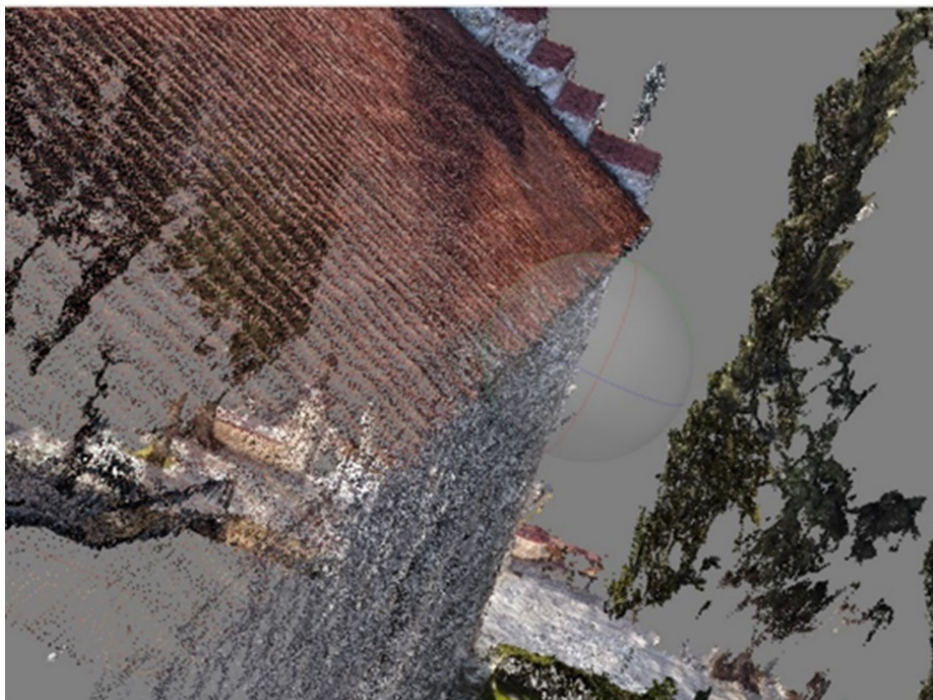

Figure 15. Dense cloud detail [Authors]

3. DATA PROCESSING AND RESULTS

Point clouds were processed using the proprietary software platform Leica Geosystems Cyclone. The final registered point cloud had an accuracy of less than 1 cm (Figure 16).

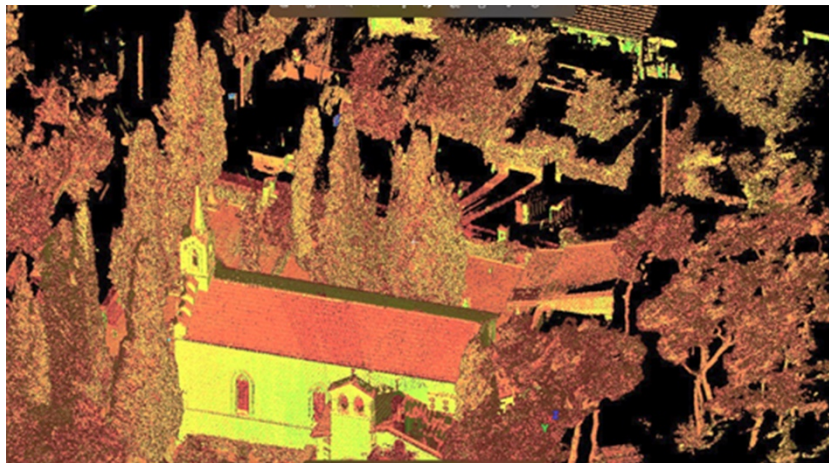

Figure 16. *The view of registered point cloud [Authors]*

The difference between the coordinates derived by total station measurements and the modelled point cloud gave RMS in the order of 1.2 cm.

The main product of combined laser data and imagery data was orthophoto of the church (Figure 17).

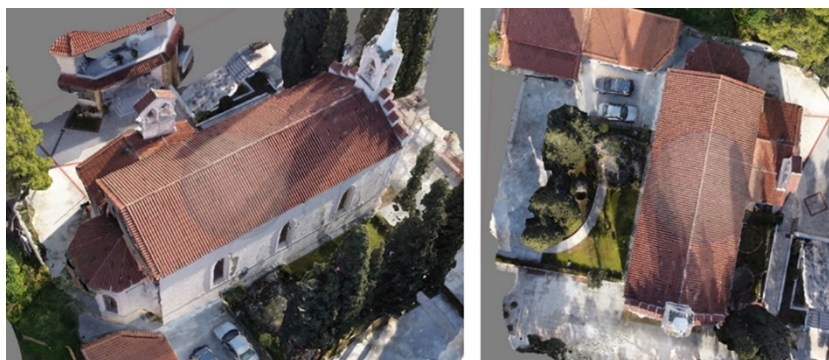

Figure 17. *Left: Textured side view of the model. Right: Orthophoto. [Authors]*

After determining the levels of modelled building and tying the objects to their levels, walls, windows, doors, roof and stairs were modelled with the use of created families (Figure 18).

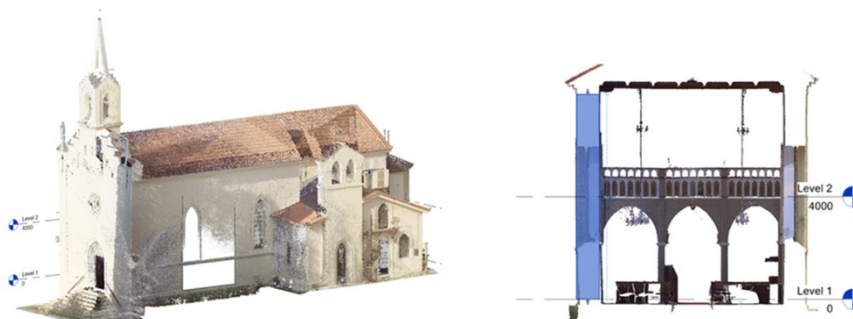

Figure 18. *Left: Reference height set at certain levels. Right: Remodeled BIM model along the point cloud data information. [Authors]*

The BIM church model was created in the last work stage. Generally, BIM offers advantages to architects and engineers as they can automatically extract 2D plans with all georeferenced views.

Moreover, additional views can be automatically extracted at any time and not limited to the predetermined set of 2D drawings.

In this work, the BIM - REVIT (Revit Autodesk) environment was used. Registered 3D point cloud was exported in Recap format and then imported to the BIM for further modelling. Although detailed description of modelling process is not within the context of this article, the indicative results are shown to depict some aspects of the model. Overall, regular surfaces were modelled using the Architecture tool that exists in Revit internal library. The irregular surfaces were modelled externally by creating Component Families. For presented model, the components from standard BIM content libraries were used (e.g., arched features) and others were created when structural components (e.g., the windows) were not readily available.

To model the subject church building, a mixed approach combining simple 3D geometry with a number of repeatable parametric components was applied. During the BIM modelling, a series of compromises between modelling time, file size and model functionality (e.g., using parametric BIM components rather than the imported mesh geometry), versus modelling tolerance (i.e., how close the model is to the point cloud dataset that constitutes the primary survey record) had to be made. Figure 19 presents the final produced 3D model of the St. Luke church.

Once the components are modelled, they could be used to further produce technical documentation such as horizontal plans, elevations, sections, details and perspectives. The advantage of the BIM model over the final point cloud of a structure, amongst others, is that it offers a possibility to extract sections in longitudinal and transversal directions. These sections show structural building composition and the dimensions of various elements and surfaces.

In conclusion, the church of St. Luke in Heraklion, Athens, was fully processed, from geomatics recordings to the BIM modelling, and every architectural component was parameterized.



Figure 19. BIM model of the St. Luke church building [Authors]

4. DISCUSSION AND CONCLUSIONS

This work presented one specific possibility to generate and process geomatic data for cultural heritage buildings. To demonstrate applied methods, and to explain the process of obtaining the data, a distinct example was chosen, and that is the Catholic church of St. Luke in the settlement Heraklion in Athens, the capital of Greece. The temple, built under the order of the Greek King Otto, underwent several significant changes over time, yet its symbolic, architectural and functional values are preserved. As such, the church of St. Luke represents a valuable example of historical buildings. The emergence and the changes on temple building over time have not been holistically described in literature so far, and, in that sense, the conducted work provides contribution to existing opus of valuable examples of sacred architecture in Greece and beyond. Next to that, the contribution of this work is reflected in its educational purpose, where growing interest in digital methods for cultural heritage documenting was met by the step-by-step explanation of methodology used to harvest and process relevant data.

Recording of heritage architecture using contemporary methods, tools and equipment, as shown in this paper, shortens the time required to collect input data on physical characteristics, and the reasons for collecting these data in practice are diverse [24]. Where obtained geomatic information about architectural objects represent an input for further digital processing exclusively for the purpose of visual presentation of cultural heritage [25], a variety of visualization software tools are available. On the other hand, geometric data harvesting can be the first step in the process of developing the projects to assess existing state of building structure, estimate risk of damage and the deterioration, develop maintenance plans, or plan reconstruction of heritage architecture. In these cases, the accuracy of recording, the details, and the possibility to manipulate with produced 3D models, 2D plans and the sections, are crucial. Consequently, the possibility of choosing the software tools comes down to complex building information modeling (BIM) programs, e.g., [26, 27], with multiple integrated functions necessary for the work of professional engineers from different technical branches. In this context, the use of the state-of-the-art digital methods represents an important issue in efforts to preserve tangible heritage assets.

LITERATURE

- [1] N. Haala and M. Kada, "An update on automatic 3D building reconstruction", *Journal of Photogrammetry and Remote Sensing*, vol. 65, pp. 570–580, 2010.
- [2] P. Musialski, P. Wonka, D.G. Aliaga, M. Wimmer, L.J. Gool and W. Purgathofer, "A survey of urban reconstruction", *Computer Graphics Forum*, vol. 32(6), pp. 146–177, 2013.
- [3] Y. Verdier, F. Lafarge and P. Alliez, "LOD generation for urban scenes", *ACM Transactions on Graphics*, vol. 34(3), pp. 1–14, 2015.
- [4] P. Dorninger and N. Pfeifer, "A comprehensive automated 3D approach for building extraction, reconstruction, and regularization from airborne laser scanning point clouds", *Sensors*, vol. 8(11), pp. 7323–7343, 2008.
- [5] L. Truong-Hong and D.F. Laefer, "Quantitative evaluation strategies for urban 3D model generation from remote sensing data", *Computers and Graphics*, vol. 49, pp. 82–91, 2015.
- [6] W. Ostrowski, M. Pilarska, J. Charyton and K. Bakula, "Analysis of 3D building models accuracy based on the airborne laser scanning point clouds", *The International Archives of the Photogrammetry, Remote Sensing and Spatial Information Sciences*, vol. XLII-2, pp. 797–804, 2018.
- [7] A. Çabuk, A. Deveci and F. Ergincan, "Improving heritage documentation. Photogrammetry and GIS in Turkey", *GIM International*, vol. 21(9), 2007.
- [8] K. Lambers, H. Eisenbeiss, M. Sauerbier, D. Kupferschmidt, Th. Gaisecker, S. Sotoodeh and Th. Hanusch, "Combining photogrammetry and laser scanning for the recording and modelling of the late intermediate period site of Pinchango Alto, Palpa, Peru", *Journal of Archaeological Science*, vol. 34(10), pp. 1702-1712, 2007.
- [9] M. Sauerbier and H. Eisenbeiss, "UAVs for the documentation of archaeological excavations", *IAPRS&SIS*, vol. 38(5), pp. 526-531, 2010.
- [10] K. Jaalama, N. Fagerholm, A. Julin, J-P. Virtanen, M. Maksimainen and H. Hyypä, "Sense of presence and sense of place in perceiving a 3D geovisualization for communication in urban planning – Differences introduced by prior familiarity with the place", *Landscape and Urban Planning*, vol. 207, 103996, 2021.
- [11] *Αρχαιολογία* Online. Internet: www.archaiologia.gr, [27.12.2021].
- [12] F. Chiabrando, L.M. Turco and C. Santagati, "Digital invasions: from point clouds to historical building object modeling (H-Bom) of a UNESCO WHL site", *The International Archives of the Photogrammetry, Remote Sensing and Spatial Information Sciences*, vol. XLII-2n(W3), pp. 171–178, 2017.
- [13] A. Fryskowska and J. Stachelek J, "A no-reference method of geometric content quality analysis of 3D models generated from laser scanning point clouds for hBIM", *Journal of Cultural Heritage*, vol. 34, pp. 95–108, 2018.
- [14] F.J. López, P.M. Lerones, J. Llamas, J. Gómez-García-Bermejo and E. Zalama, "A framework for using point cloud data of heritage buildings toward geometry modelling in a BIM context: A case study on Santa Maria la Real de Mave church", *International Journal of Architectural Heritage*, vol. 11(7), pp. 965-986, 2017.
- [15] D. Stober, R. Žarnić, D. Penava, M. Turkalj Podmanicki and R. Virgej-Đurašević, "Application of HBIM as a research tool for historical building assessment", *Civil Engineering Journal*, vol. 4(7), pp. 1565-1574, 2018.
- [16] Google Maps. Internet: <https://www.google.com/maps>, [26.02.2022].

- [17] 3D Imagery in Google Earth. Internet: <https://earth.google.com>, [26.02.2022].
- [18] Archives of the Catholic Church in Syros, Greece [20.01.2022].
- [19] Γ. Θ. Μαλτέζος, Το χρονικόν του Ηρακλείου – Αττικής. Αθήνα: Έκδοσις Ανατολής, 1970.
- [20] Heidelberg Historic Literature – Digitized. Karten von Attika: Karten — Berlin, 1895-1903. Internet: <https://digi.ub.uni-heidelberg.de/diglit/curtius1895a/0009>, [25.02.2022].
- [21] e-ΠΟΛΕΟΔΟΜΙΑ Γεωγραφική Αναζήτηση Πληροφοριών. Internet: <http://gis.epoleodomia.gov.gr/v11/#/23.7744/38.6426/6>, [25.02.2022].
- [22] Θ. Κοντερής, Έρευνα και οδηγός της Αττικής, Νέον και Παλαιόν Ηράκλειο. Αθήνα: Ν. Τυπέρογλου, 1935.
- [23] Archives of the Catholic Church of Saint Luke, Athens, Greece, [15.01.2022].
- [24] G. Pavlidis, A. Koutsoudis, F. Arnaoutoglou, V. Tsioukas and C. Chamzas, “Methods for 3D digitization of cultural heritage”, *Journal of Cultural Heritage*, vol. 8(1), pp. 93-98, 2007.
- [25] F. Windhager, P. Federico, G. Schreder, K. Glinka, M. Dörk, S. Miksch and E. Mayr, “Visualization of cultural heritage collection data: State of the art and future challenges”, *IEEE Transactions on Visualization and Computer Graphics*, vol. 25(6), pp. 2311-2330, 2018.
- [26] S. Fai, K. Graham, T. Duckworth, N. Wood and R. Attar, “Building information modelling and heritage documentation”, In *Proc. 23rd International Symposium, International Scientific Committee for Documentation of Cultural Heritage (CIPA)*, Prague, Czech Republic, 2011, pp. 12-16.
- [27] F. Chiabrando, V. Donato, L.M. Turco and C. Santagati, “Cultural heritage documentation, analysis and management using building information modelling: state of the art and perspectives”, in *Mechatronics for Cultural Heritage and Civil Engineering. Intelligent Systems, Control and Automation: Science and Engineering*, vol. 92. E. Ottaviano, A. Pelliccio and V. Gattulli, Eds. Cham: Springer, 2018, pp. 181-202.

67

Professional paper | Стручни рад
DOI 10.7251/STP2215680J
ISSN 2566-4484



Stefan Jovanović, Geovektor s.p. for design and construction, Široki Brijeg,
stefan.jova1990@gmail.com
Sanja Tucikešić, University of Banja Luka, sanja.tucikesic@aggf.unibl.org

3D MODELS BASED ON UAV IMAGES AND GNSS TECHNOLOGY IN THE FIELDS OF ARCHITECTURE, CIVIL ENGINEERING, SPATIAL PLANNING, AND ENERGETICS

Abstract

The paper presents projects in the fields of architecture, spatial planning and energetics, in order to analyze the quality of 3D terrain models obtained by combining photogrammetry using drone images (UAV) and terrestrial measurements obtained by GNSS technology. In terms of geometric accuracy, the geometry of the reconstructed point clouds was controlled in three different projects. The achieved geometric accuracy met the criteria of required accuracy defined by clients. Further, the paper provides an overview of the advantages and disadvantages of such a methodology, as well as a review of the legislation that accompanies UAV systems in Bosnia and Herzegovina / Republika Srpska.

Keywords: 3D model, UAV, GNSS technology

3D МОДЕЛИ НА ОСНОВУ UAV СНИМАКА И GPS ТЕХНОЛОГИЈЕ У ОБЛАСТИМА АРХИТЕКТУРЕ, ГРАЂЕВИНАРСТВА, ПРОСТОРНОГ ПЛАНИРАЊА И ЕНЕРГЕТИКЕ

Сажетак

У раду су представљени пројекти из области архитектуре, просторног планирања и енергетике, у сврху анализе квалитета 3Д модела терена добијених комбинацијом фотограметрије примјеном снимака беспилотне летјелице (UAV) и терестичких мјерења добијених примјеном GPS технологије. У погледу геометријске тачности у склопу сва три пројекта спроведене су контроле геометрије реконструисаних тачака. Постигнута геометријска тачност је испунила критеријуме захтјеване тачности. Даље кроз рад даје се осврт на предности и недостатке једне овакве методологије, као и осврт на законску регулативу која прати UAV системе на просторима Босне и Херцеговине/Републике Српске.

Кључне ријечи: 3D модел, UAV, GNSS технологија

1. INTRODUCTION

Geodesy, as an extremely practical scientific discipline, used the potential of information and technological development of society and led to the possibility of modernization in data collection procedures. Solutions developed exclusively for military purposes are now available for civilian use. One of them is a drone that has a camera or laser scanner on its platform. By definition, UAV (*Unmanned Aerial Vehicle*) is a device used for flying without the direct presence of the pilot or other crew member in/on the device itself [1]. The control of such an aircraft is performed with the help of a system for remote flight control and navigation or based on a previously defined flight path. The drone is certainly the most common synonym for UAV.

The division of unmanned aerial vehicles can be defined based on the maximum mass of the unmanned aerial vehicle during takeoff, range, ie. distances about the control/base point, flight altitude, construction, type of engine/drive, degree of flight autonomy and purpose. The maximum mass of the drone during takeoff varies from a few hundred grams to several tons. The distance to the control/base point can reach up to 500 km in the model of military-tactical drones. Flight altitudes range from a few hundred to several thousand meters.

Legislation that accompanies unmanned aerial vehicles on the territory of Bosnia and Herzegovina (and thus the Republika Srpska) is trying to keep pace with the development of technology, which greatly facilitates their application in geodesy, ie. in the fields of photogrammetry and remote sensing. In the territory of Bosnia and Herzegovina, drones with a maximum take-off mass of up to 25 kg may be used for civilian use. For performing, works from the air, and the official category to which photogrammetric recordings belong, BHDCA (Bosnia and Herzegovina Directorate of Civil Aviation) provides privileged flying opportunities, with the obligatory consent of the organization of the same name. This is mostly reflected in the maximum allowable altitude of drones (other categories, non-commercial and commercial operations must not exceed 120 m), as well as the maximum distance of the drone from the operator (for other categories this value is a maximum of 500 m) [2].

In terms of construction, two types of drones have been singled out for photogrammetry. These are multi-copters and unmanned aerial vehicles with fixed wings (Figure 1). Of course, it is important to accent that both types of these devices have advantages and disadvantages. Fixed-wing aircraft can reach higher altitudes and "cover" a larger area than multi-helicopters in the same period time. On the other hand, they require a specific space for takeoff and landing, the wind is a big obstacle, and the important fact is that they can not stay in one place in the air (which is the advantage of multi-copters, for example, while shooting facades with camera). The choice of aircraft for a particular photogrammetric survey will in any case depend on a number of factors, such as the scope of work, the location of the site, obstacles, and accuracy requirements.



Figure 1. *Unmanned aerial vehicles that have found their application in photogrammetry* [3], [4]

The question remains whether photogrammetry / remote sensing detection by drones will become an indispensable way of collecting data in certain branches of geodesy, ie. in jobs and projects on which architects, civil engineers and technicians, spatial planners, computer scientists, mechanical engineers, and experts in related sciences work. This paper presents examples from practices that were successfully implemented during 2021. The following text will present the methodology of data collection and processing, analysis of the obtained results as well as a review of the advantages and disadvantages of drone photogrammetry.

2. METHODOLOGY

Photogrammetric survey with the help of UAV has found practical application within projects in the field of architecture, construction, spatial planning and energetics in the territory of the Republic of Srpska. Specific tasks, presented in this paper, are related to:

- Development of a 3D model of the quarry for the purpose of monitoring the amount of stone ore excavation (Project 1),
- Development of a 3D model of the business zone for the needs of designing its reconstruction (Project 2), and
- 3D reconstruction of the industrial zone (facilities and terrain) for the needs of solar park design (Project 3).

It is important to note that in all these cases, the accent was placed on meeting the technical requirements of the tasks (in terms of accuracy and density of generated spatial data) and safe execution of data collection by drone in accordance with all prescribed laws to which these works are subject.

2.1. AREA OF PHOTOGRAMMETRIC SURVEY AND COVERAGE OF THE FIELD

Prior to the planning of the work from the air, a general check was performed on whether the survey area was banned from flying unmanned aerial vehicles, ie. whether a BHDCA permit is required. Figure 2 shows exactly one such location, where the territory (around Banja Luka airport) is divided into zones with a special regime for flying drones. The red zone prohibits flying, the blue zone requires BHDCA approval, while the gray zone sets limits on the maximum height of the drone.

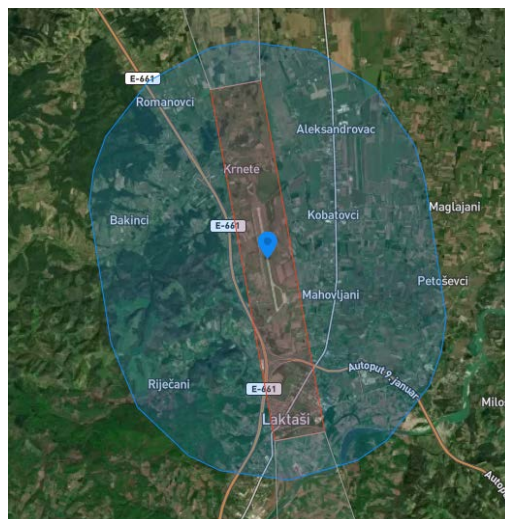

Figure 2. Prohibition and restriction zones for UAV [5]

2.1.1. Project 1

The quarry in question is located on the territory of the municipality of Laktaši in the village of Drugovići. It can be reached by the highway on January 9 (about 700 meters from the Drugovići exit) or on the main road Banja Luka-Prnjavor. The approximate area of the quarry is 18.5 ha. The subject of the survey was its southern and south-eastern branches, with an area of 3.2 ha, ie. the dimensions of the object to be photographed (average length and width) were 250 m and 130 m. The maximum relative height difference of the part of the quarry that was photographed was 60 m. The request of the client was defined on the basis of the allowed deviation of the geometric accuracy. For the detailed points it was 10 cm with respect 3 axes.

2.1.2. Project 2

The business zone is located in the municipality of Šipovo. Its distance from the municipal center is 400 m (on the left side of the Jezero-Šipovo road from the direction of Jezero). It includes a gas station with accompanying sales facilities (which are on two levels/floors), three industrial halls (for storage of pellets and other wood products, repair of machinery and vehicles), external storage of wood raw materials, and accompanying road and utility infrastructure. The average dimensions of the subject were 200 m in length and 100 m in width. The maximum allowed deviation of detailed points (defined by the client) was 5 cm.

2.1.3. Project 3

The industrial zone that was the subject of the survey is located on the territory of the city of Prijedor. The area survey covers a total area of 2 ha. On this surface, there are industrial facilities, warehouses, water towers, tool shops, warehouses of secondary raw materials, garages, and transformer stations. Unlike the previous two projects, the client required a more detailed reconstruction of the associated facilities. Emphasis is placed on the roof structure in order to obtain a base for the design of solar panels on these surfaces.

2.2. DATA COLLECTION METHOD

Data (photographs and coordinates of orientation/control points) for all three projects, were collected in the same way, ie. a combination of a drone (has an integrated GNSS receiver, but is not good enough to independently achieve the required accuracy of the reconstructed points) and GNSS terrestrial measurements (using the RTK method) are combined.



Figure 3. Overview of orientation points used in Project 1

The drone used on these projects is the DJI Phantom 4 Pro V2.0. Its take-off weight is 1375 g. The flight duration (using one battery) is 25 min. It has an integrated GNSS receiver that receives GNSS and GLONASS satellite constellation signals. The digital (integrated) camera (Table 1) is connected by a 3-axis gimbal. It can be rotated towards the nadir, which allows vertical shots.

Table 1. Characteristics of the DJI Phantom 4 Pro V2.0 drone camera

Focal length (f)	35 mm
Sensor width (WS)	35.9 mm
Sensor height (HS)	24 mm
Field of View (FOV)	37.8 °
Active pixels	20 million

Prior to the implementation of data collection, a detailed flight plan was prepared (Table 2), which includes the length and width of the area to be recorded (L and W), the height of the aircraft (H), Ground Sample Distance (GSD), longitudinal and transverse overlaps of attached photographs (LO and SO), longitudinal and lateral movement of the drone (LS and SS), number of shots per survey line (NI), number of shooting lines (NS), and the total number of shots (TI).

Table 2. Flight Plan for Project 2

L	200 m
W	100 m
H	40 m
GSD	5 mm
LO	75 %
SO	75 %
LS	6.84 m
SS	6.84 m
NI	29
NS	15
TI	426

2.3. DATA PROCESSING

The processing of the collected data (photographs and coordinates of orientation points) was performed using the 3Dsurvey program. The processing procedure is extremely intuitive and follows the following steps:

- Opening a new project and uploading photos,
- Adding telemetry to photographs (based on the aircraft model or by importing an additional document containing information related to the position of the cameras' center at the time of exposure),
- Choice of horizontal and vertical date/projection,
- Montage photos and create points cloud with connections points,
- Geo-referencing of the project (based on the coordinates of orientation points),
- Reconstruction of the dense point cloud (4 possible densities),
- Making of a digital surface model,
- Making of a orthophoto.

3D models for all three projects were delivered in the form of point clouds, so the reconstruction of the dense point cloud was the last step in the processing. The duration of individual phases within Project 2 is shown in Table 3.

Table 3. Step-by-step data processing time for Project 2

Upload photos	4 min
Adding telemetry and selecting geodetic dates	8 min
Making points clouds of the connections points	1 h 25 min
Geo-referencing	1 h 15 min
Reconstruction of the dense point cloud	6 h 32 min

3. RESULTS, ANALYSIS AND DISCUSSION

According to the program manufacturer's declaration, the geometric error of details (arbitrary points from the cloud) has a value 2.5 times higher than the maximum error of the orientation points. In order to be convinced of the truth of this statement, geometry checks were performed at checkpoints. In the case of Project 1, "redundant" orientation points were set up in the field, which did not enter the geo-reference process. They served as checkpoints. Information on their position was collected during field measurements with a geodetic GNSS receiver and after the reconstruction of a dense cloud of points, a comparison of the digitized point from the cloud and recorded with an instrument was made (Table 4). In Projects 2 and 3, in addition to the control points, clearly visible details (edges of sidewalks, terraces, manhole covers) were read with a geodetic GNSS receiver in order to control the geometry of the reconstructed points. The analysis of the comparison shows that the detailed points from the cloud (in all Projects) met the set accuracy requirements.

For each point obtained from the point cloud, in addition to its geometry, the color is copied in the RGB system based on photographs, ie. the point cloud got a real-world texture. This fact allows 3D modeling of terrain and objects with the help of unmanned aerial vehicles to give a multi-purpose product. Through the Projects, this was reflected in the following way:

- In Project 1, it was clear where the extraction of stone ore was performed and based on that, find out how much ore was exploited and in which part (Figure 4),
- In Project 2, using the CAD module of the 3Dsurvey program, details (for which no field sketch was kept at all) were mapped by layers, which were later merged in AutoCAD (Figure 5),
- In Project 3, in addition to the geometry of the buildings necessary for the design of the solar park, a solution was obtained that provides a clear insight into the current state (collapse) of roofs and walls of industrial buildings (Figure 6).

Table 4. Project result parameters

Project parameters	Project 1	Project 2	Project 3
Number of photos used	348	419	1321
Number of points in the 3D model	70 million	118 million	87 million
Average geometric accuracy of georeferencing [mm]	11	7	16
Total data processing time	8 h 44 min	7 h 22 min	10 h 17 min

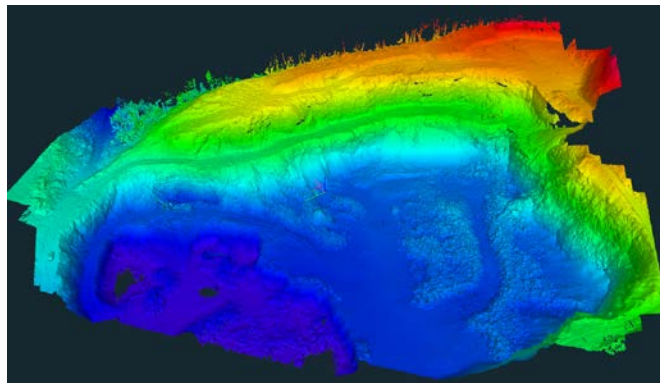

Figure 4. 3D model of the quarry with the help of a hypsometric scale



Figure 5. Part of the point cloud with mapped details



Figure 6. 3D view of the industrial zone model (left view) with automatically generated "X-ray" image of the walls (right view)

4. CONCLUSION

The shortcomings of the described methodology are not numerous, but certainly not negligible. Before the implementation of the project, several test flights were performed to define the best way to perform future air data collection operations. Applications that enable the automatic realization of flight and photogrammetric recording were tested. At that moment, none of them proved to be reliable, so each of the flights was controlled directly by the drone operator. Reduced or excessively large transverse/longitudinal folding of photos in the model is one of the potential problems that can be caused by manually guiding the drone. If there is too little overlap, the reconstruction will not be adequate. On the other hand, too much overlap will create redundant photos that will slow down the data processing procedure. The time that the drone will spend in the air will certainly increase. In addition, the general problem of photogrammetry is the reconstruction of surfaces that are uniform, such as aluminium roofs. This problem can be avoided by increasing the operational altitude of the aircraft, so that the photos "capture" another detail that will be crucial for finding the tie points and later reconstructions of the dense point cloud. This measure can impair positional accuracy and Ground Sample Distance (GSD). Absolute accuracy assessment RMSE for 3D spatial coordinates is 11.1 mm in project 1, RMSE for 3D spatial coordinates is 7.10 mm in project 2, and RMSE for 3D spatial coordinates is 16.3 mm in project 3. Accuracy is reported at the 95% confidence level. Relative changes in the RMSE show a clear decrease with an increasing mean distance. The technology that is present in the field of photogrammetry provides solutions that can speed up the data collection procedure. Unmanned aerial vehicles are being developed that collect data on the principle of Real-Time Kinematic (RTK) and Post-processed kinematic (PPK) methods. The costs of such equipment should certainly be taken into account, as well as the possibility of their cost-effectiveness. For practical examples, which are presented in this paper, drones are a great solution for obtaining 3D models. The results with their quality (in terms of geometric accuracy) and quantity (which surpasses all geodetic measurements except laser scanning / LIDAR) meet absolutely all the technical requirements set by the clients. In the near future, photogrammetry / remote sensing of drones will become an indispensable way of collecting data in certain branches of geodesy, ie in jobs and projects involving architects, civil engineers and technicians, spatial planners, computer scientists, mechanical engineers and experts.

LITERATURE

- [1] U.S. Department of transportation-Federal Aviation Administration (FAA). (2013). Integration of Civil Unmanned Aircraft System (UAS) in the National Airspace System (NAS) Roadmap. (First Edition) [On-line]. Доступно на: www.faa.gov/uas/resources/policy_library/media/uas_roadmap_2013.pdf [7.2.2022.]
- [2] Правилник о условима за извођење летачких опрација дрoновима. Закон о ваздухопловству Босне и Херцеговине („Службени гласник Бих“, број: 39/09 и 25/18).
- [3] DJI. „<https://www.dji.com/phantom-4-rtk>” [17.2.2022.]
- [4] WINGTRA. „<https://wingtra.com/>” [17.2.2022.]
- [5] DJI. „ <https://www.dji.com/flysafe/geo-map>” [19.2.2022.]



Vinko Šutalo, Hering dd, Široki Brijeg, vinkosutalo@gmail.com
Dragan Macanović, University of Banja Luka, dragan.macanovic@aggf.unibl.org
Dragana Skorup, University of Banja Luka, dragana.skorup@aggf.unibl.org

PROCEDURE FOR PREPARATION OF TECHNICAL DOCUMENTATION FOR REGISTRATION OF CONDOMINIUM OWNERSHIP

Abstract

For efficient state development, regulated land administration is core. The biggest part of achieving this goal is the activity on organizing efficient land administration. Implementing the number of projects in Federation of Bosnia and Herzegovina and Republic of Srpska is partially managed to get the administration to another level. The activity aims are to provide unambiguous data in and land register and to connect them with the real situation on the land. Recording of condominium units improves land administration and contributes to the development of the real estate market, making planning documents and economic development.

Keywords: land administration, real estate, floor unit, land register.

ПОСТУПАК ИЗРАДЕ ТЕХНИЧКЕ ДОКУМЕНТАЦИЈЕ ЗА УПИС ЕТАЖНОГ ВЛАСНИШТВА

Сажетак

Уређена земљишна администрација је основ за ефикаснији развој државе. За остваривање тог циља од великог значаја су активности на развоју ефикасне земљишне администрације. Реализацијом низа пројеката у Федерацији Босне и Херцеговине и Републици Српској, земљишна администрација је већ дјелимично подигнута на виши ниво. Циљ активности је да се обезбједе једнозначни подаци у катастру и земљишној књизи који одговарају стању на терену. Евидентирање етажних јединица унапређује земљишну администрацију и доприноси развоју тржишта некретнина, олакшава доношење планских докумената и покретање других активности битних за развој привреде.

Кључне ријечи: земљишна администрација, катастар некретнина, етажна јединица, земљишна књига.

1. УВОД

Уређена земљишна администрација и уређени земљишно-правни односи услов су за привредни развој било које земље или њеног дијела, јер се њиховим рјешавањем повећава могућност будућих инвестиција, које су јако отежане у условима потпуне неажурности и несређености система. У циљу уређења земљишне администрације и развоја исте по узору на развијене земље Европе, у Босни и Херцеговини (БиХ) се проводио низ пројеката из ове области. У раду се представља процес израде елабората етажирања на основу ког се врши упис етажних јединица, односно упис власништва у јавне регистре (земљишне књиге, књиге положених уговора и слично) у Федерацији Босне и Херцеговине (ФБиХ) и у катастар непокретности у Републици Српској (РС). Уписом етажних јединица у јединствену евиденцију постиже се висок степен уређености земљишне администрације, неопходан за тржиште непокретности, израду планских докумената и друго.

2. ПРЕДМЕТ ИСТРАЖИВАЊА

Развој градова условљава ширење урбане средине на којој се гради велики број стамбених али и пословних објеката. Потреба за сигурним власништвом захтијева утврђивање и регистрацију права на објектима али и посебним дијеловима објеката у јавним евиденцијама (регистрима).

Етажно власништво је власништво на посебном дијелу објекта који се може користити као самостална цјелина. [1] Иако је овај поступак на нашим подручјима познат још од осамдесетих година прошлог вијека, тек задњих неколико година постао је значајан, а нарочито реализацијом Пројекат регистрације некретнина (ПРН), који је уједно покренуо и дигао на виши ниво упис етажног власништва новоизграђених стамбених, стамбено-пословних и пословних објеката. Наизглед једноставан поступак отежавају многи фактори, а понајвише недостатак адекватних законских и подзаконских аката.

Предмет истраживања је израда техничке документације на основу које носиоци права на етажним јединицама стичу могућност уписа права на непокретностима у земљишну књигу у ФБиХ, односно у катастар непокретности у РС.

Конечно, уписом права на непокретностима у јавне регистре постиже се вишеструка корист за појединце, власнике етажних јединица и за читаво друштво, будући да стање земљишно-књижне политике увелико утиче на развој привреде.

У нашем окружењу, у задњих петнаест година, зачајан напредак у оснивању катастра недвижности и доступности података путем глобалне интернет мреже остварен је у Сјеверној Македонији, као и у Србији у оквиру катастра непокретности.

2.1. ПРОПИСИ

У ФБиХ, етажирање правно постоји, али не постоје довољно детаљно прописани стандарди везани за његово извођење. Углавном етажирање се врши у договору с урбанистичким службама локалних јединица. Постоје индиције да ће се у будућности и на том пољу десити неке промјене, али за сада се то своди на могућност различитог тумачења постојећих закона без одговорности.

Законска регулатива према којој се врши етажирање у ФБиХ је Закон о стварним правима ФБиХ („Службене новине Федерације БиХ“, број: 66/13); Закон о земљишним књигама („Службене новине Федерације БиХ“, број: 54/04); Закон о премјеру и катастру некретнина Социјалистичке Републике Босне и Херцеговине - СР БиХ („Службени лист СР БиХ“, број: 22/84). У Херцеговачко-неретванској жупанији Закон о управљању и одржавању заједничких дијелова и уређаја зграда („Народне новине Херцеговачко-неретванске жупаније“, број: 01/06). Дуги низ година актуелан је, али није још усвојен Преднацрт закона о премјеру и регистрацији некретнина.

У РС, такође постоји пракса уписа етажних јединица у јавни регистар. У поступку одржавања и провођењу промјена у Земљишној књизи, до ступања на снагу катастра непокретности законски основ за упис права у поступку етажирања је Закон о земљишним књигама РС, а на подручју гдје се оснива катастар непокретности то је Закон о премјеру и катастру РС („Службени гласник Републике Српске“, 06/12, 110/16 и 62/18), Правилник о оснивању и одржавању катастра непокретности РС („Службени гласник Републике Српске“, 11/14, 25/14 и 31/15) чиме се дефинише оснивање и одржавање катастра непокретности, гдје спада и етажирање и упис власништва на етажним јединицама [1].

2.2. ЕТАЖИРАЊЕ

Отварањем слободног тржишта и прелазак многих некретнина из државног или друштвеног власништва у приватно појавила се потреба за евиденцијом тих некретнина као и појмом етажног власништва.

Етажирање је поступак успоставе власништва на посебном дијелу некретнине и оно остаје неодвојиво од одговарајућег сувласничког дијела на објекту на чијем дијелу је успостављено власништво. Услов је да је посебни дио некретнине уједно и самостална употребна јединица (цјелина) јасно одвојена од других. Правно посматрано то је модификација сувласништва према којој власник посебног дијела некретнине успоставом етажног власништва може извршавати сва власничка овлаштења и дужности самостално.

Данас се углавном етажирање проводи у стамбеним и стамбено-пословним зградама и то за станове, пословне просторије, гараже и подрумске просторије (опционо) као самосталне јединице.

Такође етажно власништво може се протезати и на споредне дијелове који не служе за становање или обављање пословне дјелатности, односно најчешће имају секундарну функцију, као на примјер за складиштења ствари или за одмор, као што су балкони, терасе, подруми, тавани, кућни вртови и мјеста за паркинг. Да би се етажно власништво протезало и на споредне дијелове, они морају бити разграничени од некретнине и доступни с међе некретнине или из њених заједничких дијелова. Они требају представљати самосталне јединице што се тиче коришћења, имати властити улаз, имати одређеног власника, односно да нису остављени на коришћење свим станарима зграде.

У заједничке дијелове зграде спадају конструктивни елементи зграде, заједничке просторије зграде, инсталације зграде, уређаји у згради и остали заједнички дијелови зграде. Важно је раздвојити заједничке дијелове зграде од заједничких просторија у које спадају стубишни простори с оградом, ходници и галерије, подрумски простори, терасе, поткровља - тавани, заједничка спремишта, и просторије за скупљање отпада. Подрумски простори, терасе и поткровља спадају у заједничке просторије под условом да њихово коришћење не зависи од једне употребне цјелине.

Сврха етажирања је израда документације на основу које се врши упис посебних дијелова некретнине у јавне регистре некретнина и права на њима. У ФБиХ се за упис посебних дијелова некретнине у земљишну књигу, отварају земљишно-књижни улошци посебно за сваку употребну цјелину и тим поступком се коначно стичу стварна права на етажној јединици. Власник етажне јединице стиче власништво на њој као и на одговарајућем сувласничком дијелу парцеле на којој се налази. Етажирање се изводи прикупљањем података из постојеће документације и на терену на основу чега се израђује елаборат.

На основу одлуке власника или споразумом сувласника некретнине успоставља се етажно власништво тј. сувласници некретнине се могу договорити да своје идеалне дијелове претворе у етажно власништво тако што ће сваки сувласник имати власништво на етажној јединици повезано са сувласничким дијелом у згради.

План посебних дијелова зграде мора да садржи податке о катастарској парцели на којој је објекат изграђен као и адресу и кућни број објекта те тлоцрт из кога се види положај објекта у простору [2]. Садржај елабората углавном се израђује у договору с урбанистичком службом јединице локалне самоуправе, па се стога елаборати етажирања разликују, али сви садрже текстурални (описни) дио и графичке прилоге.

Елаборат етажирања могу израдити овлаштени пројектант архитектонске струке, овлаштени геодетски стручњак и овлаштени инжењер грађевинарства. Особе које врше поступак етажирања морају имати положен стручни испит код надлежних органа.

У ФБиХ, израђени елаборат претходно мора овјерити урбанистичка служба јединице локалне самоуправе, чиме потврђује исправност садржаја елабората, те да ли су предметне етажне јединице заиста самосталне цјелине у погледу коришћења на начин како је дефинисано законом, док у РС садржај елабората (тлоцрта) контролише и овјерава надлежна подручна јединица Републичке управе за геодетске и имовинско-правне послове (РУГИПП).

Овјерени елаборат у ФБиХ се предаје у земљишно-књижни уред надлежног суда за катастарску општину у којој се налази некретнина заједно са захтјевом за упис власништва. У РС елаборат се предаје у надлежну подручну јединицу РУГИПП-а. Надлежни радник подручне јединице провјерава техничку исправност елабората односно, садржај елабората прописан законом или пројектним задатком код ПРН и исправност докумената на основу којих се врши упис.

Битна ставка у елаборату су тлоцрти и рекапитулација површина. Тлоцрт етажне јединице требао би бити нацртан у одговарајућој размјери са оријентацијом положаја објекта у простору и положаја етажне јединице у објекту. Наведени услови често нису испуњени, али се упркос томе такви тлоцрти, неоправдано, ипак користе у пракси. Осим техничке исправности докумената провјерава постојање правног основа за упис власништва на етажној јединици у земљишној књизи (ЗК), односно катастру непокретности (КН), а након тога приступа се упису власништва на етажној јединици, како је прописано Законом о земљишним књигама у ФБиХ, односно Законом о премјери и катастру РС.

Етажирање се у већини случајева проводи на новоизграђеним објектима на захтјев инвеститора које треба уписати права на некретнинама у јавне регистре и веома је битно да се омасовљава овај поступак етажирања новоизграђених објеката прије продаје етажних јединица. У земљишну књигу уписују се и јединице староградње, рјеђе на захтјев странака, али чешће кроз ПРН који проводи Федерална управа за геодетске и имовинско-правне послове (Федерална геодетска управа - ФГУ). Што се тиче израда елабората било за новоизграђену зграду или само једну јединицу унутар ње или етажне јединице у староградњи алгоритам израде је увијек исти и на исти начин се проводи процедура независно о старости етажне јединице. Код етажних јединица у староградњи се често јављају компликације везане за власништво или неподударање површина из уговора и стварне површине.

Будући да се на овим просторима врши хармонизација, односно усклађивање катастарских и грунтовних података, етажирање се може посматрати као један аспект хармонизације и да се етажне јединице уписују (региструју) у ЗК, односно КН на основу података катастарске измјере (премјера) у оквиру ПРН који реализују ФГУ и РУГИПП.

2.3. КЊИГА ПОЛОЖЕНИХ (УЛОЖЕНИХ) УГОВОРА

У Књигу положених уговора (КПУ) се уписују етажне јединице у случају када некретнина није уписана у земљишну књигу. Води се одвојено за сваку катастарску општину и то у земљишно-књижном уреду надлежног суда. Уписи у КПУ су се најчешће вршили за етажне јединице које су стечене приватизацијом, на основу станарског права или када се некретнина налазила на парцели у друштвеној својини што је био најчешће случај у бившој држави (Слика 1).

КПУ се састоји од главне књиге и збирке исправа. Поред тога још се воде и помоћне књиге као што су: именик власника станова и попис уписаних станова.

Главна књига се састоји од подуложака, а сваки подуложак се води за један стан. Подуложак се састоји од три листа и то према [3] А лист или пописни лист, Б лист или власнички лист, и Ц лист или теретни лист са истим садржајем и функцијом као и ЗК уложак.

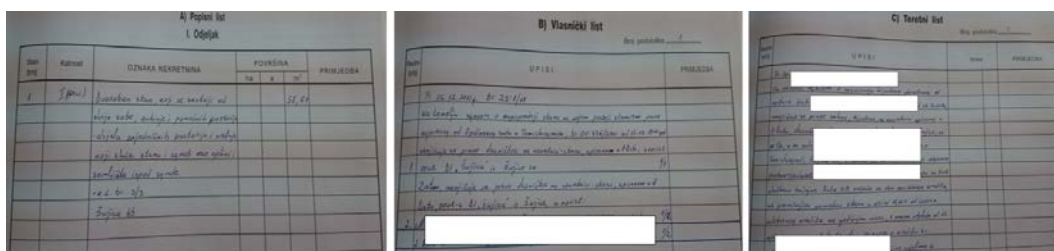

Слика 1. Пописни А лист, Власнички Б лист и Теретни Ц лист Књиге положених уговора [3]

Специфичан, модернизовани облик евиденције права на пословним просторима је Е-књига која егзистира само за пословне просторе у свега пар општина у ФБиХ (Неум, Чапљина, Завидовићи...)[4]

Други дио Е-књиге је земљишно-књижни спис који припада одговарајућем подулошку и он представља графички опис пословног простора. У одговарајући образац уцртава се тлоцрт предметног пословног простора те уносе основни земљишно-књижни и катастарски подаци те рекапитулација просторија.

За сваки пословни простор уписан у Е-књигу израђује се тлоцрт објекта који се прилаже у Е-књигу, и садржи најбитније информације о пословном простору (адреса на којој се налази објекат, назив КО, тлоцрт објекта, положај објекта у оквиру зграде и табела површина по просторијама са сумарником површина.

Пописни лист за зграде и посебне дијелове зграда се води у облику табеле са описним подацима о етажној јединици. Неке расположиве податке поједине судске службе за

имовинско-правне послове не региструју јер нису од значаја за власничке односе, док су ти подаци битни за урбанистичке службе јединица локалне самоуправе. Будући да Е-књига није заживела на ширем подручју јер се није радило на модернизацији и рационализацији саме књиге то је довело до тога да се у обрасцима води много непотребних информација. За идентификацију етажне јединице и власништва треба биљежити само неопходне информације. У скорој будућности биће неопходно усагласити сет потребних информација тако да се не оптерећује земљишна администрација, а електронске базе података ће омогућити увид и издавање података о етажним јединицама по различитим основама, као што су нпр. намјена етажне јединице, врста власништва и сл..

2.4. ПРИМЈЕР ИЗРАДЕ ЕЛАБОРАТА ЕТАЖНИХ ЈЕДИНИЦА

На копији плана су видљиве линије катастарских парцела, бројеви катастарских парцела, линије (границе) зграде, катастарски број зграде и предметна парцела.

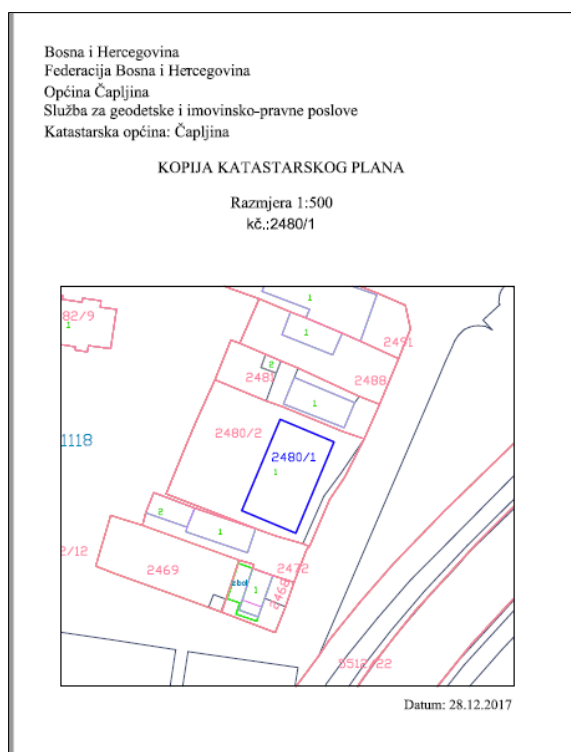

Слика 2. Примјер копије катастарског плана [4]

Када се прикупи потребна документација приступа се анализи исте и теренским радовима у сврху прикупљања осталих података о етажној јединици у склопу објекта, што подразумева израду тлоцрта етажне јединице и одмјерања елемената неопходних за рачунање корисне површине етажне јединице.

Приликом израде тлоцрта могу се користити рјешења из архитектонских пројеката, а уколико иста нису доступна, извођач радова својеручно скицира положај просторија унутар етажне јединице те их означава на прописани начин. Заједнички дијелови зграде, на скици означени као „ZDZ”, су дијелови који су неопходни за кориштење самосталних јединица, а није их могуће користити самостално. У њих спадају: ходиници зграде, стубишта, лифтови, терасе, балкони и слично.

Скице етажних јединица треба да буду израђене у размјери и етажна јединица треба бити оријентисана као што је на терену. У пракси је најчешће потребно само да су јасно разграничени дијелови етажних јединица, заједнички дијелови зграде и да се наведу њихови називи и површине (Слика 2).

Такође потребно је именовати сваку етажну јединицу у склопу објекта на начин да свака носи ознаку UnJn (n=1, 2, 3, ...) при чему слово У означава број улаза у склопу улице и слово J означава број етажне јединице у склопу зграде.

Именовање се врши на начин да се свакој етажној јединици додијели споменућа ознака кренувши од подрума према врху зграде, док се на сваком спрату додјељивање ознаке врши на начин да прво добијају јединице лијево од улаза па се даље додјељује у смјеру казаљке на

сату. На слици приказан је тлоцрт другог спрата зграде која је почетна у низу зграда. Сваки спрат има три стана. Водећи се овим алгоритмом предметни стан ће добити ознаку U1J5.

1. KAT

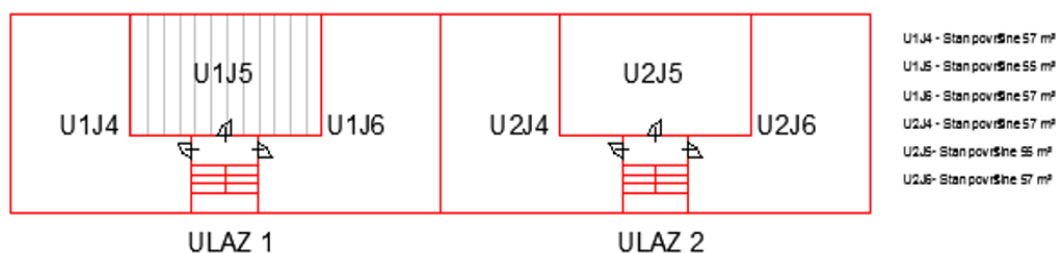

Слика 3. Предметни стан U1J5 [4]

Именовања се врше на основу тлоцрта који су саставни дио елабората и на њима је потребно именовати етажне јединице. Формирање тлоцрта одвија се у двије фазе. Првобитно се на предметној локацији ручно скицира предметна етажна јединица и премјере дужине страна зидова помоћу мјерних инструмената за то намијењених и на скици се на сваки зид исписује њихова дужина до на центиметар. Такође, уколико се премјеравају и унутрашње просторије потребно је назначити њихов назив, односно сврху. Након тога тлоцрт се исцртава у канцеларији у одређеној размјери и рачунају се површине. Раније се тај поступак радио ручно док се то данас обавља помоћу рачунара, користећи софтверски пакет AutoCAD.

Површина добијена рачунањем из одмјерања уноси се у елаборат и то би требала бити корисна површина. Према једној од дефиниција то је површина коју етажна јединица заузима, умањена за дебљину зидова [1]. Друга дефиниција каже да је збир површина свих подних просторија које одговарају намјени и функцији објекта помножених с одговарајућим коефицијентом за поједине просторије [5]. Појам корисна површина првенствено користе стручњаци грађевинске и архитектонске струке, за своје потребе и као такав за геодетске елаборате није прикладан. У катастарске евиденције уносе се површине објеката које својим габаритима заузимају у простору. При изради елабората користи се модификована корисна површина, коришћењем коефицијената за подне површине појединих просторија према грађевинским нормативима. Ова врста површине била би најприкладнија за унос у Регистар некретнина будући да се обично вриједност некретнине рачуна као производ квадратуре подних површина и вриједности једног квадратног метра изражена у одређеној валути. Могућа опција за навођење површине у Регистру некретнина могла би бити навођење површине коју објекат заузима, уз навођење ставки појединих квадратура подних површина свих етажних јединица. Овакав приступ садржи потребне информације за тржиште некретнина и тиме се осигурава поузданост и јединственост података Регистра некретнина. Остале врсте површина, као што је бруто грађевинска површина, више су податак који служи за контролу задовољења самог пројекта и добијање грађевинских дозвола, а такви подаци своју сврху проналазе у урбанистичким службама.

Након што је прикупљена документација и извршени теренски радови приступа се изради елабората. Већ је споменуто да не постоји конкретан правилник о изради елабората тако да га извођач углавном израђује према властитом шаблону или у договору с урбанистичком службом јединице локалне самоуправе. Према Закону о земљишним књигама потребно је посједовати уговор о диоби и диобни план етажних јединица, али у пракси је углавном садржај елабората нешто другачији.

2.5. ЕТАЖИРАЊЕ У СКЛОПУ ПРОЈЕКТА РЕГИСТРАЦИЈЕ НЕКРЕТНИНА

ПРН је пројекат чији је основни циљ развој одрживе земљишне администрације на подручју Босне и Херцеговине који егзистира с усклађеним катастарским и земљишно-књижним евиденцијама на подручју ФБиХ и РС, који је са реализацијом започео 2013. године када је ратификован Споразум о финансирању између БиХ и Међународне асоцијације за развој.

У ФБиХ пројектом управља ФГУ послове и Федерално министарство правде (одговорно за дио пројекта везан за земљишну књигу). Унутар ФГУ је успостављена Јединица за имплементацију пројекта према Пројектном задатку – Техничке спецификације за хармонизацију – усаглашавање података о некретнинама катастра и земљишне књиге [6]. Данас се проводе завршне активности пројекта и очекује се да ће друштво имати велике

користи од бољег управљања земљиштем, односно некретнинама подржаног ажурним и лако доступним просторним информацијама о некретнинама као и трансакцијама на њима.

Пројект се реализовао кроз три основне компоненте [6]:

- **Компонента А** односи се на ЗК са циљем побољшања транспарентности, брзине и тачности земљишнокњижних уписа путем развоја услуга, модернизације прописа и базе података, планирања приоритетних активности за сваку годину, унапређења радних услова модернизацијом опреме и просторија за рад, укључивања регистрације станова и осталих самосталних јединица у систем укњижбе у ЗК, хармонизације катастарских и грађевинских података и усклађивања података из ЗК са стањем на терену.
- **Компонента Б** односи се на катастар, а циљ активности је побољшање ефикасности и брзине пружања катастарских података путем развоја услуга, укључујући и пласирање података путем интернета, модернизације прописа, израде софтвера за похрањивање, обраду и дистрибуцију просторних података, подршке развоју пословног планирања, пружања материјалне и стручне помоћи за провођење подршке припреми законске регулативе и унапређења процедуралних приручника, пружања стручне помоћи развоју унапређења праћења и контроле квалитета, систематских уписа, картирања и анализе стања у одабраним зонама, ажурирања катастарских података кроз разне пилот пројекте, дигитализације катастарских планова и архива, превођење у електронску форму да би се сачувала и развијала информационо-комуникациона технологија и развоја јединственог катастарског рачунарског система.
- **Компонента Ц** се односи на развој и управљање Пројектом путем модернизованих законских регулатива, стратегија и правилника по узору на регулативе развијених европских земаља.

На подручју Републике Српске РУГИПП такође, проводи овај пројект и он има идентичне компоненте са специфичним изведбама, али са истим циљевима, да модернизују прописе, опрему и просторије за рад, оснују катастар непокретности са усклађеним подацима путем јавног излагања, те израде Централни адресни регистар. Такође, један од приоритета је модернизација информатичке опреме и система с циљем управљања подацима у дигиталном облику.

У ФБиХ, као што је наведено, дио овог пројекта је и хармонизација катастарске и грађевинске евиденције у оквиру које се врши идентификација и етажирање [6].

Етажирање у склопу овога пројекта врши се систематски за читаве катастарске општине у којима се налазе етажне јединице уписане у КПУ. Етажне јединице уписане у КПУ заправо представљају јединице које су биле предмет откупа током приватизације.

2.6. УПИС ЕТАЖНЕ ЈЕДИНИЦЕ У ЗК

Реализација пројекта врши се у складу са прописаним корацима дефинисаним од стране ФГУ у пројектном задатку [6]:

- Преузимање података и документације (из земљишне књиге и из катастра);
- Израда и усвајање санационог плана (ажурирање податка о некретнинама катастарског операт) и његово провођење кроз катастарски операт;
- Израда диобних планова зграда (означавање етажних јединица комбинацијом - УнЈн гдје је У број улаза, Ј број јединице, и премјером јединице уколико се површина у уговору и на терену не слаже) и пренос података о етажним јединицама постојеће земљишне књиге и књиге положених уговора у базу података земљишне књиге (БПЗК)-е по новом премјеру и
- Израду XML (Extensible Markup Language) документа у складу са XSD (XML Schema Definition) схемом за унос података о етажним јединицама у БПЗК.

Ова фаза подразумијева упис етажне јединице у земљишну књигу тако да се отвори нови ЗК уложак на основу израђене техничке документације. Примјер ЗК уложка за гаражу (слика 4).

Podaci o ulošku					
Broj uloška:	5990	KO:	ČAPLJINA		
Broj parcela u ulošku:	1	Suma površina parcela: 0ha 0a 15m ²			
Status:	Aktivan				
Na izabranom ulošku nema tereta.					
Lista nađenih parcela					
Red. št.	Broj parcele	Naziv	Adresa	Površina parcele	Plomba
1	5635/E25	Garaža broj 25 u suterenu u površini 15m ² sa suvlasničkim dijelom 15/2246 na zajedničkom dijelu nekretnine oznacene kao k.c. 5635		15m ²	Ne
Lista nađenih vlasnika					
Red. br. ↓	Omjer	Podaci o vlasniku	Adresa		
1	1/1	XXXXXXXXXXXX	XXXXXXXXXXXXXXXXXXXXXXXXXXXX		
Podaci o ulošku					
Broj uloška:	6491	KO:	ČAPLJINA		
Broj parcela u ulošku:	1	Suma površina parcela: 0ha 0a 66m ²			
Status:	Aktivan				
Na izabranom ulošku nema tereta.					
Lista nađenih parcela					
Red. št.	Broj parcele	Naziv	Adresa	Površina parcele	Plomba
1	5682/7-E10	Stan broj 10 na II katu u površini 66m ² sa suvlasničkim dijelom 66/1407 na zajedničkom dijelu nekretnine oznacene kao k.c. 5682/7		66m ²	Ne
Lista nađenih vlasnika					
Red. br. ↓	Omjer	Podaci o vlasniku	Adresa		
1	1/1	XXXXXXXXXXXX	ul. Petra Krešimira IV br 5 Čapljina		

Слика 4. Примјер уписа гараже [4]

Приказани начин нумерисања је једноставнији из разлога што се нумерација врши по редослиједу уписа, али тешко даје просторну представу локације етажне јединице, те је прихватљивији начин нумерисања етажне јединице унутар зграде.

Тренутна пракса је да се у грађевинској бази брише стара парцела, односно она егзистира у онолико дијелова колико се налази етажних јединица на њој. Претходно је споменут назив парцеле унутар кога се даје опис етажне јединице на начин да се наводи његова површина, матична парцела, те сувласнички удио који представља размјер површине етажне јединице и укупне површине етажних јединица на парцели.

Осим грађевинске, постоји и катастарска евиденција у катастрима јединица локалне самоуправе ФБиХ. У катастру се воде посједовни листови по катастарским општинама, а те парцеле на којима се налазе етажне јединице се воде као „друштвена својина” у власништву општина или друштвених фондова преосталих из бившег државног система.

3. СТАЊЕ У БОСНИ И ХЕРЦЕГОВИНИ

Ситуација на пољу земљишне администрације како у ФБиХ, тако и у РС још увијек није на задовољавајућем нивоу, али у последње вријеме реализује се неколико пројеката који би увелико земљишну администрацију дигли на одговарајући ниво. Осим великог броја различитих и застарјелих облика евиденција што их чини недоступним широј јавности и што у коначници ограничава анализирање стања, у пракси се често јављају проблеми дијелом настали због непостојања адекватне законске регулативе и тешко их је рјешити због локалне надлежности [7].

Катастарски подаци у РС воде се у централизираној управи (РУГИПП) са сједиштем у Бањој Луци и подручним јединицама на подручју читаве територије РС чиме је уједначена пракса и јасна одговорност запосленика подручних јединица РУГИПП-а.

За разлику од РС у ФБиХ постоји нешто компликованија ситуација у којој није јасно дефинисана одговорност појединаца запослених у институцијама јединица локалне самоуправе. За све послове у вези премјера и регистрације некретнина на нивоу ентитета одговорна је ФГУ.

Други ниво по важности су жупанијске институције у виду управа за геодетске и имовинско правне послове четири жупаније и то: Жупаније Западно-херцеговачке (Љубушки), Херцеговачко-неретванска жупанија (Мостар), Средњо-босанска жупанија (Бугојно) и Ливањска жупанија (Ливно). Запосленици ових управа одговорни су владама жупанија, односно премијеру жупаније.

Трећи, али можда и најважнији у погледу ажурирања, похране и дистрибуције података је локални ниво гдје су запосленици локалних служби за геодетске и имовинско-правне послове директно одговорни начелницима јединица локалне самоуправе. Овакав јаз између институција за геодетске и имовинско-правне послове у ФБиХ за посљедицу има смањен ниво контроле и одговорности у стварању, контроли и коришћењу података. Резултат овога је непостојање јавно-приватног партнерства те велики број неријешених предмета у већини општина ФБиХ, поготово на подручју ове четири жупаније на којима егзистирају жупанијске управе. Као што се може закључити у РС је боља ситуација јер постоји велики број приватних предузећа за геодетске послове и самим тим степен контроле је много развијенији.

Међутим, што се тиче проблематике овога рада евидентно је да постоји тренд уписа етажних јединица новоизграђених стамбено-пословних објеката. Претпоставка је да је овај тренд посљедица немилих ситуација које су се догађале у прошлости гдје се због несређених имовинско-правних односа купци етажних јединица нису могли уписати као власници. Управо то је утицало да се будући купци информирају код стручних служби о обавезама уписа у земљишну књигу. Данас, у вријеме када постоји високоразвијена технологија и већина становништва посједује интернет прикључак могуће је провјерити стање било које етажне јединице у земљишној књизи помоћу базе земљишно-књижних уреда постављене на веб сите „e-grunt.ba”. Оно што је битно да потенцијални купац уколико пронађе жељену етажну јединицу у горе наведеној бази може бити сигуран у истинитост података.

Нажалост, поред свега овога није било могуће доћи до података који би дали уопштену слику о стању уписа новоизграђених етажних јединица у земљишну књигу.

За разлику од новоизграђених етажних јединица, постоје и оне које су уписане у Књигу уложених уговора која је представљена у претходним поглављима. Управо те етажне јединице предмет су уписа у земљишну књигу у склопу ПРН односно једног облика усклађивања катастарских и грунтовних података. За реализацију било ког пројекта битни су претходни радови односно анализа постојећег стања.

Оно што је евидентно је да се посљедњих година земљишна администрација у оба ентитета у Босни и Херцеговини развија по узору на земљишну администрацију земаља западне Европе, те да су досад реализовани пројекти вјероватно почетак низа пројеката који ће се проводити на овом подручју у циљу стварања уређене земљишне администрације јавно доступне свим грађанима.

Развој информационих технологија и олакшан приступ интернету, геопросторне податке учинио је доступним на лак и разумљив начин. Појавом геопортала [8] и његовом једноставном употребом, сви подаци из ПРН, након што постану службени (најчешће за 3 до 6 мјесеци), могу се преклапати са сателитским и ортофото снимцима ради лакше оријентације. Ортофото снимке би требало ажурирати сваке године како би се испратиле све промјене простора које се дешавају невјероватном брзином и како би се добила релевантна представа простора. На подручју ФБиХ користи се ортофото из 2018. године.

Такође, познато је да се и у РС проводе многе активности на развоју земљишне администрације у склопу ЦИЛАП пројекта [9]. Проблематика у РС везана је за успоставу катастра непокретности на цијелом подручју РС будући да још увијек егзистира неколико врста, односно типова евиденција [10]:

- катастар на основу премјера који је извршила аустро-угарска на дијеловима на којима су успоставили катастар,
- катастар земљишта (катастар заснован на новом премјеру (измјери), који је најзаступљенији,
- пописни катастар на непремјереним територијама у мањем обиму,

- катастар непокретности (нова јединствена евиденција некретнина и права на њима).

Већ је споменуто да у РС постоји пракса уписа етажног власништва над новоизграђеним етажним јединицама и на етажним јединицама у староградњи које су биле предмет откупа, у склопу овога пројекта, односно у оквиру поступка оснивања катастра непокретности. Чињеница је да су ови пројекти земљишну администрацију у РС подigli на много виши ниво јер је убрзан и ефикаснији рад РУГИПП-а, а тиме су се створили услови за ефикаснији промет некретнинама, смањење броја неријешених предмета, лакше урбанистичко планирање и као један од важнијих показатеља повећање инвестиција.

4. КАРАКТЕРИСТИКЕ ПОСТУПКА ЕТАЖИРАЊА

Детаљно анализирајући овај поступак врло лако се може закључити да уређено стање на овом подручју увелико утиче на развој шире друштвене заједнице, те осим што представља основ за тржиште некретнина он омогућава просперитет и привредни раст одговарајуће средине. Међутим, чињеница да не постоји довољно детаљно и јасно дефинисана законска регулатива која би се посебно бавила овим подручјем, чини га непознатим широј друштвеној заједници. Крајњи резултат овог поступка је израђена техничка документација на основу које се стиче правни основ за упис власништва на етажној јединици у ЗК. Власник етажне јединице тим чином може у потпуности изводити радње за правни промет, али у складу с постојећом законском регулативом. За подручје БиХ карактеристична је несређеност евиденција некретнина, и овим поступком се даје допринос рјешавању имовинско-правних односа.

Такође, предност је израда елабората у дигиталном облику и унос података у дигиталне базе земљишно-књижних уреда, односно у базу Федералног министарства правде познатију под називом „Е-грунт”. Међутим, база није у потпуности прилагођена овом поступку, те поред развоја законске регулативе потребно је развити и информациони систем за упис етажних јединица који би омогућио да се евидентирају историјске чињенице и промјене које су настајале на честицама. Такође, увођење технологије BIM (Building Information Modeling) и његова шира примјена у пракси би могла дати значајан допринос уредног вођења промјена.

И коначно, постојање неколико видова евиденција некретнина доноси неповјерење код грађана, а ПРН би се затворила Књига положених уговора што у коначници повећава степен развијености земљишне администрације.

На почетку овог поглавља јасно је наведено да недефинисан правни основ представља највећи недостатак етажирања што за посљедицу има мањи значај за сам поступак.

Све ово наведено увелико доприноси малверзацијама при правном промету на некретнинама, па се често дешава да појединци услед тога буду оштећени за велике новчане износе. Није риједак случај да се испостави да продавач етажне јединице није стварни власник над њом.

5. ЗАКЉУЧАК

Анализирајући тренутно стање земљишне администрације и активности које се воде у тој области може се закључити да израда техничке документације на основу које ће се уписати етажно власништво у земљишне књиге представља велики корак за унапријеђење земљишне администрације по узору на развијене европске земље.

Овај простор је одувјек био на удару различитих свјетских сила чији се утицај може видјети и на развоју различитих евиденција и прилагођавању земљишних евиденција БиХ евиденцијама различитих држава које су владале овим простором. Резултат тога јесте велики број различитих евиденција које су неажурне и неусаглашене са стварним стањем. Проблем се рјешава примјеном и финансирањем различитих пројеката како би се евиденције унаприједиле.

Препрека бржем развоју земљишне администрације у ФБиХ је недовољна законска и подзаконска регулатива која на недвосмислен и јасан начин регулише питања израде техничке документације, којом се дефинишу положај, облик и друге карактеристике етажних јединица и тиме испуњавају услови за упис етажних јединица (некретнина) стварних права на њима у регистре власништва. У РС су донесени законски и пратећи подзаконски акти чиме су створени услови за ефикасније оснивање одговарајућег регистра непокретности, права на непокретностима и носиоцима тих права чиме се унапријеђује земљишна администрација. Чини се корисним размотрити усаглашавање правних прописа и правилника за поступање (у оба ентитета) који су засновани на добрим праксама и искуствима у оба ентитета и у Европској унији (ЕУ). Хармонизирани правни прописи би дали подстрек привредном развоју било које земље или њеног дијела.

На основу досадашњег искуства у провођењу ПРН, као и проведених истраживања и анализе, може се закључити да регистрација некретнина односно упис власништва на етажним јединицама доводи до уређене земљишне администрације, изграђене по европским стандардима. То се нарочито огледа у савременом начину прикупљања и обраде података који су доступни и транспарентни ширем кругу корисника (грађана, органа управе, привредника-потенцијалних инвеститора), што омогућава употреба модерних информационих технологија.

Уређена земљишна администрација, такође, је један од услова за приступање ЕУ, те ће БиХ као потенцијални кандидат имати обавезу осим провођења разних пројеката усвојити и законске акте којима ће се регулисати функционирање земљишне администрације у циљу њеног континуираног развоја.

И на крају, може се видјети да израда техничке документације даје неопходне податке о етажној јединици на основу којих се стиче право уписа у земљишну књигу и то је један од корака ка успостави јединствене евиденције о некретнинама на овим подручјима чиме се рјешава проблематика власништва на етажним јединицама која је веома раширена због ширења урбаних средина задњих 30 година.

ЛИТЕРАТУРА

- [1] Републичка управа за геодетске и имовинско-правне послове, „Правилник о оснивању и одржавању катастра непокретности Републике Српске“, „Службени гласник Републике Српске“, бр. 11/14, 25/14 и 31/15.
- [2] I. Tušinec „Etažiranjem do vlasničkih ovlasti“, *Ekscentar*, No 7. Studentski Zbor Geodetskog fakulteta Sveučilišta u Zagrebu, Zagreb, vol. 23-29, 2005.
- [3] D. Kontrec, „Upis etažnog vlasništva (vlasništva posebnog dijela nekretnine) u zemljišnoj knjizi (s posebnim osvrtom na upise izvršene prije stupanja na snagu Zakona o vlasništvu i drugim stvarnim pravima, dvojbe i problemi u praksi)“, *Zbornik Pravnog fakulteta Sveučilišta u Rijeci*. Vol. 30, No. 1, vol. 703-724, 2009.
- [4] V. Šutalo, „Izrada tehničke dokumentacije za upis etažnog vlasništva.“ Master rad, Arhitektonsko-građevinsko-geodetski fakultet, Banja Luka, 2019.
- [5] Republička uprava za geodetske poslove i katastar nekretnina, „Pravilnik (sa priložima) o izlaganju na javni uvid podataka premjera i katastarskog klasiranja zemljišta i određivanje upisa prava na nekretninama“, Socijalistička Republika Bosna i Hercegovine, Sarajevo, 1989.
- [6] Federalna uprava za geodetske i imovinsko-pravne poslove, „Projektni zadatak-Tehničke specifikacije za harmonizaciju-usaglašavanje podataka o nekretninama katastra i zemljišne knjige“, 2017.
- [7] I. Lesko, E. Mehmedovic, Ž. Obradovic, „Cadastral and Land Registry Harmonization in the Federation of Bosnia and Herzegovina“, *FIG Working Week 2015. From the Wisdom of the Ages to the Challenges of the Modern World*. Sofia, Bulgaria, (https://fig.net/resources/proceedings/fig_proceedings/fig2015/papers/ts06b/TS06B_lesko_mehmedovic_et_al_7700.pdf), [25.11.2019].
- [8] Geoportal, Internet: <https://www.katastar.ba/geoportal>, 2015 [14. 1. 2022.]
- [9] CILAP, Internet: <https://www.rgurs.org/stranica/cilap>, 2013 [15. 1. 2022.]
- [10] D. Macanović i M. Đurić, „Od nastanka katastra u Bosni i Hercegovini do katastra nepokretnosti kao registra nepokretnosti i stvarnih prava na njima“, *Zbornik radova, VI. Hrvatski kongres o katastru*, 11.-14.4.2018, Zagreb, str. 29-36, 2018.



Radovan Đurović, University of Montenegro, radovandj@ucg.ac.me
Ivan Mrdak, University of Montenegro, ivanm@ucg.ac.me
Gojko Nikolić, University of Montenegro, gojkorn@ucg.ac.me
Zoran Sušić, University of Novi Sad, zsusic@uns.ac.rs
Marko Marković, University of Novi Sad, marko_m@uns.ac.rs

GEODETTIC WORKS ON THE CONSTRUCTION OF THE MRKE TUNNEL IN THE CONTEXT OF METHOD OF EXECUTION OF WORKS AND GEOMORPHOLOGICAL CONDITIONS

Abstract

In this paper geodetic works during the excavation of tunnels are presented, with specific example of Mrke Tunnel on the highway section Smokovac - Mateševo in Montenegro. All phases of geodetic works have been presented, such as the construction of underground and overground geodetic networks, control of tunnel excavation process, as well as geodetic works on the monitoring of radial deformations during the excavation. The New Austrian Tunnel Method (NATM) has been implemented for the excavation of the Mrke Tunnel, therefore the concept of active geotechnical design was presented and the review of specific geodetic works on surveying and monitoring with reference to its application was provided. The geomorphological conditions of the surveyed structure have also been presented.

Keywords: geodetic network, tunnel excavation, monitoring, New Austrian Tunnel Method

ГЕОДЕТСКИ РАДОВИ НА ИЗГРАДЊИ ТУНЕЛА МРКЕ У КОНТЕКСТУ ТЕХНОЛОГИЈЕ ИЗВОЂЕЊА РАДОВА И ГЕОМОРФОЛОШКИХ УСЛОВА

Сажетак

У овом раду се разматрају геодетски радови при ископу тунела са конкретним примјером тунела Мрке на дионици аутопута Смоковац – Матешево у Црној Гори. Презентован је низ фаза геодетских радова као што су израда подземних и надземних геодетских мрежа, контрола пробоја као и геодетски радови на мониторингу радијалних деформација током ископа. За ископ тунела Мрке је примијењена Нова аустријска тунелска метода (НАТМ) па је у оквиру рада презентован концепт активног геотехничког пројектовања и дат приказ специфичних геодетских радова на осматрању и мониторингу при њеној примјени. Приказани су и геоморфолошки услови посматраног објекта.

Кључне ријечи: геодетска мрежа, пробој тунела, мониторинг, Нова аустријска тунелска метода

1. УВОД

Изградња тунела представља комплексан подухват у коме учествују стручњаци различитих профила. Геодезија, чија је улога у том пројекту од великог значаја, незаобилазна је у свим фазама изградње. За разлику од других грађевинских објеката, тунели садрже низ специфичности, што се посебно односи на опсежне припремне радове и комплексност геодетских радова током пробоја и изградње [6].

Циљ израде пројекта геодетских радова у пробоју тунела је да се уради оптимизација тих радова: геометрије, тачности, грешака, броја и тачности мјерења елементарних величина у мрежи. Пројекат дефинише инструменте, методе, услове тачности и услове рада, којим треба извести мјерења елементарних величина у мрежи изабране геометрије у циљу добијања геодетске мреже одговарајућег квалитета.

Поред контроле осовине ископа тунела у задатим границама толеранције пројекта, веома је важно да се профил тунелске цијеви изведе што тачније, јер свако одступање од идеалног профила доноси додатне трошкове извођачу или инвеститору при извођењу тунела. Тачна и прецизна слика ископа тунелске цијеви служи не само као податак за касније радове у тунелу, већ штеди вријеме и материјал потребан за касније фазе изградње тунела. Сви ови као и многи други геодетски радови у тунелу као што су ископчење портала, израда цијевних штитова, ниша, проширења или тунелских пролаза, изградња вертикалних шахтова итд., зависе прије свега од квалитета геодетске мреже, како надземне тако и подземне.

Посебан аспект извођења тунела из угла интеракције између геодета са осталим инжењерима укљученим у ископ тунела је извођење ископа Новом аустријском тунелском методом (НАТМ). НАТМ је концепт тунелградње којим се активним геотехничким пројектовањем тежи остварити оптималан однос сигурности и економичности. Из тог разлога ископ тунела са НАТМ-ом подразумијева могућност да се дозволи помјерање контуре стијене ископа па је важан аспект ове методе контрола радијалних деформација. Радијалне деформације су главни показатељи стабилности ископа па је улога геодетских инжењера врло важна како би се обезбиједила сигурност људства и опреме током извођења и обезбиједили тунелским инжењерима одговарајући подаци да ли су претпоставке при извођењу биле одговарајуће.

2. ТУНЕЛ МРКЕ

Тунел Мрке се налази на дионици аутопута од Смоковца до Матешева. Предметна дионица је дио Аутопута Бар-Бољаре који је дио путног правца ТЕМ ("Trans European Motorway") кроз Црну Гору. Вишеструко је значајан: повезује не само основни правац ТЕМ-а (од Гдањска до Атине и Истанбула) са Јадранским морем, него представља и дио коридора аутопута Београд – Јужни Јадран преко Трансевропске Магистрале, чији је дио крака, који пружа европску, а преко Луке Бар и медитеранску оријентацију Црне Горе, односно повезује Подунавље са Медитераном. Дионица од Подгорице до Матешева је дужине 42 км, и има 16 двоцијевних тунела и 26 мостова. Укупна дужина тунела укључујући обје цијеви је 35.5 км. Лијеви портал тунела МРКЕ почиње од станице ЛК5+150 и завршава на станици ЛК5+989. Десни портал тунела почиње од станице РК5+142 и завршава на станици РК5+946. Тунел је са јужне стране повезан са мостом Горње Мрке а са сјеверне стране се кроз дио пута спаја са мостом Морачица. Седиментне творевине у којима се налази улазни портал тунела Мрке припада ретилијасу (Т,Ј). По литолошком саставу то су слабодолмитични кречњаци, доломитични кречњаци и кречњаци а појављују се у виду слојева или банака. Седименти Доња јура-лијас (J_1) изграђују знатан дио терена у којима је извршен пробој тунела Мрке. Представљени су фацијом литиотиских кречњака ($J_1^{2,3}$). У наставку трасе и излазног портала тунела, у зони Ждрвња, су терени које изграђују јурско-кредни кречњаци сиве, свјетлосиве и блиједожуте боје (Ј,К)[4].

Крашки георељеф примарно обухвата зону тунела Мрке. Ријеч је о геопростору који представља једну морфоструктурну цјелину у виду флувиоденудационе површи. Тектонским процесима површ је дјелимично дисецирана и у њој су развијене рјечне долине Мораче и Мале ријеке. Позитивна вертикална кретања доводе до спуштања карстне издани и зоне карстификације, због чега се у издигнутој зони јављају развијени холокарст с мезо и микро облицима (вртаче, долови, шкрапе), посебно у чистим партијама мезозојских кречњака.

3. ПРОРАЧУН ТАЧНОСТИ ПРОБОЈА ТУНЕЛА

За геодетске радове, начин изградње тунела врло је битан јер од њега зависе методе рада, начин стабилизације тачака и тачност мјерења.

Тачност пробоја тунела може бити битно мања при изградњи тунела методом поткопа, него што је то случај при копању тунела у пуном профилу. У првом се случају након пробоја може кориговати искључење пројектоване трасе, док се у другом пробој тунела мора остварити у оквиру унапријед постављених захтјева тачности.

Грешка пробоја тунела састоји се из три компоненте [1]:

- подужна грешка пробоја (σ_P - одступање у правцу осе тунела),
- попречна грешка пробоја (σ_L - одступање у правцу управном на правац осе тунела),
- висинска грешка пробоја (σ_H - одступање у вертикалном смислу).

Код праволинијских тунела, подужна грешка пробоја нема превише значаја, јер ће се, упркос њој, сусрет осовина догодити нешто мало раније или касније, без негативних исхода. Међутим, ако је тунел праволинијски, а повезан је са другим подземним објектима, или ако је у кривини, последице ове грешке су врло значајне. Попречна грешка пробоја штетна је без обзира која је врста тунела у питању. Услед грешке долази до непоклапања профила тунела на месту сусрета радова и јавља се такозвана паралакса. Од саобраћајних тунела ова грешка највише погађа жељезничке тунеле, где се на тим мјестима осјећају неизбјежни бочни удари. Код водних тунела на овим мјестима се под притиском јављају разарања зидова. Висинска грешка пробоја настаје због грешака висинске основе и висинског обиљежавања током грађења тунела. Кроз праксу се показало да се при пробоју постиже много већа тачност у висинском него у попречном смјеру [11].

Величина допуштеног одступања условљена је величином габаритне резерве, коју одређује пројектант. Овај податак геодетима омогућава да изврше прорачун тачности надземних и подземних мјерења, да би се пробој тунела извео с дозвољеном толеранцијом.

Прецизност се у геодезији разматра на основу стандардних одступања. Полазећи од дозвољеног одступања које је, обично, задано пројектом, требало би усвојити однос између стандардног и дозвољеног одступања (толеранције). При искључењу тунелских оса узима се да је стандардно одступање једнако половини толеранције.

Оса тунела СС (Слика 1), ако не би постојале грешке мјерења, требало би да се поклопи на мјесту сусрета два пробоја.

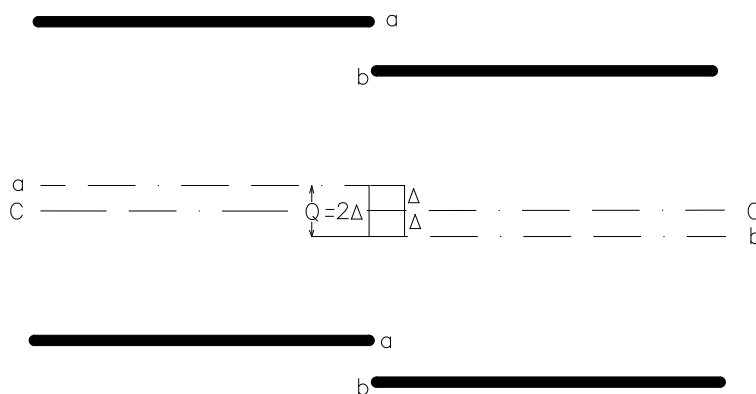

Слика 1. Дозвољена одступања мимоилажења осовина

Међутим, због познате чињенице да сва мјерења садрже неизбјежне грешке мјерења, то ће се одразити као мимоилажење оса а и б за неку вриједност $Q = 2\Delta$.

Ако је пројектом предвиђено гранично одступање у величини Δ , онда ће међусобно одступање (размимоилажење) радних оса бити 2Δ , па ће прорачун тачности у пробоју тунела полазити од ове величине као дате толеранције:

$$Q = \frac{2\Delta}{2} = \Delta \quad (1)$$

гдје је Q - укупна средња грешка свих мјерења.

Сада се на основу ове вриједности врши избор методе, инструмената и прорачунава тачност са којима треба вршити мјерења елементарних величина.

Дозвољена одступања пробоја за праволинијске тунеле која се рачунају по формулама:

$$\Delta_p = \pm 8.5 * \sqrt{\frac{L}{2}} \quad \Delta_p = \pm 8.5 * \sqrt{\frac{L}{2}} \quad (2)$$

за попречно одступање,

$$\Delta_H = \pm 3.5 * \sqrt{\frac{L}{2}} \quad \Delta_H = \pm 3.5 * \sqrt{\frac{L}{2}} \quad (3)$$

за висинско одступање,

gdje се:

Δ_p добијају у [цм] ако се L изрази у [км] [3].

У тунелу Мрке пробој тунела се одвијао истовремено са оба портала. Након пробоја, када је једна иста тачка обиљежена са двије стране добијено је попречно одступање од 1,7 цм односно вертикално 0,6 цм што је значајно далеко од дозвољених одступања у овом тунелу гдје су пројектом биле усвојене горе наведене толеранције. Узевши у обзир дужину тунела (приближна за обје цијеви) дозвољено попречно одступање је цца 5,4 цм а висинско 2,2 цм.

4. ГЕОДЕТСКЕ МРЕЖЕ ЗА ПОТРЕБЕ ИЗГРАДЊЕ ТУНЕЛА

Цјелокупна геодетска основа, микромреже испред улазног и излазног портала, као и мрежа тачака која их повезује пројектује се на карти размјере 1:5000, а саме микромреже пројектују се на топографском плану размјере 1:1000 на којем је нанесен план организације градилишта. Основа при пројектовању геодетске основе за потребе изградње било којег тунела је дозвољено одступање при пробоју тунела, што значи да геодетска основа мора задовољити највеће захтјеве у вези с прецизношћу и поузданошћу. Главне особине пројекта геодетске основе у правилу су:

- надземна геодетска основа мора имати на улазном, односно излазном порталу најмање двије тачке за пренос дирекционог угла у подземну полигометрију,
- осим тачака у близини портала потребно је стабилизovati још најмање двије контролне тачке ради прецизнијег дефинисања оријентације полигонског влака у тунелу,
- надземна геодетска основа треба бити интегрисана у државни координатни систем,
- пројекат мреже се ради на пројекту тунела, гдје су већ пројектовани и сви помоћни објекти који ће служити у току грађења,
- пројекат мреже мора покривати цијело градилиште тунела и удовољавати свим његовим потребама до краја грађења,
- мрежа мора бити хомогена за цијело градилиште тунела и одговарати тачности која је потребна за означавање тачака тунелске осовине при пробијању тунела,
- тачке надземне тунелске триангулације не треба постављати изнад саме трасе, јер током изградње може доћи до деформације терена и према томе и до помјерања тачака. То зависи и од дубине на којој ће се тунел градити и од квалитета тла кроз које тунел пролази.

Тунелска мрежа, као геодетска основа за изградњу тунела има два дијела: надземни и подземни дио.

4.1. НАДЗЕМНЕ ГЕОДЕТСКЕ МРЕЖЕ – МРЕЖА ТУНЕЛА МРКЕ

С обзиром да је тунел издужени објекат, до развоја нових технологија, надземна мрежа је по правилу имала облик једноставног ланца троуглова (Слика 2), комбинованог са два геодетска четвороугла код улазног и излазног портала тунела. У оваквој мрежи су се вршила класична терестричка геодетска мјерења.

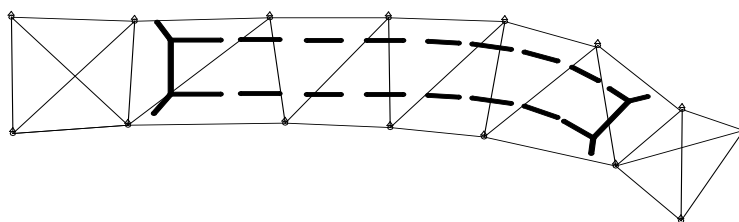

Слика 2. Надземна тунелска триангулација

У последње вријеме, употребом нових техника и технологија, ланац троуглова, замијењен је полигонометријским влаком (Слика 3), који повезује двије мање тригонометријске мреже код портала, а код краћих тунела је потпуно напуштен јер се раде само мреже код портала.

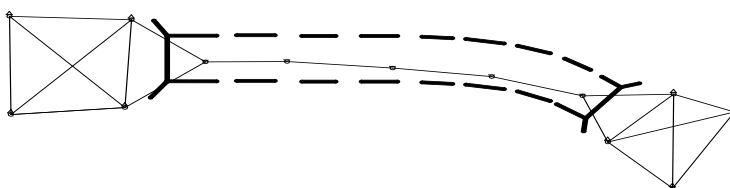

Слика 3. Надземна тунелска триангулација

Данас, када се у геодезији примјењују Глобални систем за позиционирање (ГПС) и Глобални сателитски систем за навигацију (ГНСС), за пројектовање надземне мреже се користи комбинација сателитских и терестричких мјерења. Ланац троуглова, који је за мјерења био доста тежак и компликован, јер је постављан преко планинских предјела, замијењен је прецизним полигонским влаком који повезује две порталне мреже [5].

Материјализација тачака дијела мреже код оба портала изводи се помоћу стубова за присилно центрисање инструмента и сигнала. Висина стуба над земљом обично је 1.3-1.5 м, а у пресјеку има димензије 0.4x0.4 м или је облика ваљка (Слика 4). Могуће је горњу површину уређаја за присилно центрирање дефинисати као висинску тачку што је и био случај на мрежи тунела Мрке.



Слика 4. Изглед тачака надземне геодетске мреже на тунелу Мрке

У последње вријеме, развојем ГПС технологије све више се ова метода користи код одређивања координата тачака спољне тунелске геодетске мреже, нарочито код тунела веће дужине (на свим тунелским мрежама дионице Аутопута Смоковац - Матешево коришћена је ова метода).

Општи пројектни захтјеви за мрежу за посебне намјене тунела Мрке обухватили су следеће ставке [2]:

- хоризонтално позиционирање тачака да се реализује ГПС технологијим примјеном методе релативног статичког позиционирања,
- координате тачака основне геодетске мреже аутопута користит ће се за хоризонталну датумску дефиницију мрежа посебне намјене,
- хоризонтална трансформација координата тачака у државни координатни систем треба да се изврши Хелмертовом трансформацијом сличности уз употребу постојећих трансформационих параметара, односно њихових вриједности које су биле коришћене током реализације аутопута,

- вертикално позиционирање тачака мреже тунела треба да се изврши методом геометријског или тригонометријског нивелмана,
- висине тачака основне геодетске мреже аутопута и оперативног полигона користит ће се за вертикалну датумску дефиницију мреже посебне намјене.

У ГПС мјерној кампањи кориштена су укупно три ГПС пријемника. На локацијама тачака тунелске триангулације обезбијеђено је отворено небо, радио видљивост и други услови неопходни за примјену сателитске ГПС технологије а на истима је обезбијеђена и оптичка видљивост, за потребе коришћења терестричке мјерне технологије.

На слици 5 дат је изглед тунелске мреже на улазном и излазном порталу тунела Мрке.

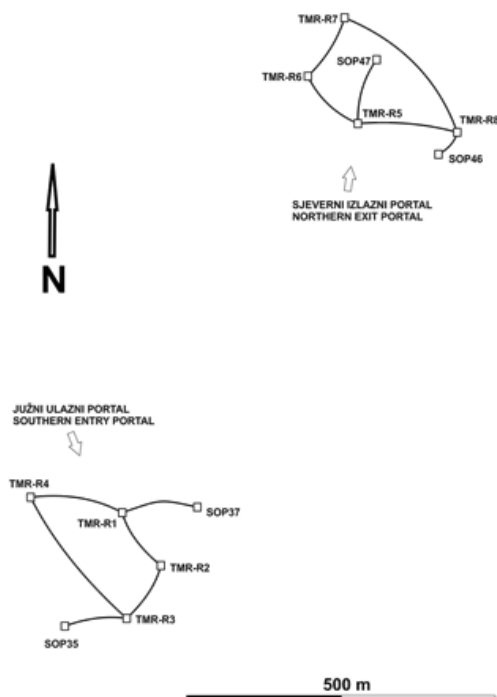

Слика 5. Изглед надземне мреже тунела Мрке

Тачке “SOP“ на слици изнад представљају тачке оперативног полигона аутопута које су “увезане“ и у мреже посебних намјена свих објеката па и тунела Мрке. Двије од четири тачке надземне мреже овог тунела укључене су у мрежу посебне намјене моста Горње Мрке који се налази непосредно прије уласка у тунел са јужне стране. За потребе контрола квалитета ГПС мјерења, формиран су затворени полигони у које је укључен сваки одређени ГПС вектор. Након тога су за сваки од полигона срачуната незатварања дуж координатних оса у хоризонталном и вертикалном смислу. Нијесу регистроване никакве грубе грешке чиме је потврђен висок квалитет ГПС мјерења.

4.2. ПОДЗЕМНЕ ГЕОДЕТСКЕ МРЕЖЕ – МРЕЖА ТУНЕЛА МРКЕ

Након одређивања координата тачака спољашње мреже приступа се ископу тунела који се заједно са свим осталим подземним радовима прати кроз привремену унутрашњу мрежу. Прије тога, потребно је оријентисати подземну мрежу, тј. успоставити геометријску везу између ње и надземне мреже јер обје морају бити одређене у истом координатном систему.

Код тунела, за оријентацију су карактеристична два случаја: када се пренос дирекционог угла и координата изводи кроз тунелске портале и случај преноса ових елемената кроз вертикална окна. У тунелу Мрке се пренос оријентације врши кроз портале тунела.

Подземна мрежа је некад развијана кроз тунел, начешће преко полигонског влака чије тачке су биле материјализоване у средини калоте. Тај влак је био доста несигуран јер је у ствари то био такозвани слијепи полигонски влак. Како тачност пробоја тунела директно зависи од тачности координата тачака геодетске мреже са које се врши обиљежавање осе тунела, слијепи полигонски влак својом геометријом није обезбијеђивао потребну тачност пробоја тунела. Данас се зато постављају два полигонска влака, са сваке стране тунела по један, тако да се са тачака једног влака могу опажати тачке другог и обрнуто. Тако се добија подземна мрежа коју чине слијепи полигонски влакови повезани дијагоналним и попречним везама.

Овако пројектована геометрија подземне мреже, која може бити ланац троуглова, геодетских четвороуглова или њихова комбинација, омогућава реализацију мреже чија тачност координата тачака може обезбиједити потребну тачност пробоја тунела.

Када се пренос дирекционог угла и координата врши преко тунелских портала постоји неколико начина за тај поступак као и начин стабилизације тачака подземне мреже.

Ове тачке је могуће поставити на бочни зид прије бетонирања секундарне облоге на начин што се у њега уграђује постоље са положајним завртњем и овај метод је коришћен у тунелу Мрке (Слика 6).

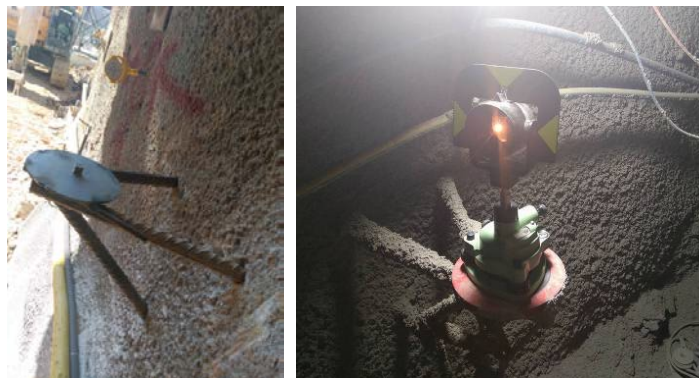

Слика 6. Стабилизација тачака подземне геодетске мреже у тунелу Мрке

На тачност координата тачака мреже, поред геометрије саме мреже, утиче тачност мјерених величина (углова и дужина), грешка почетног дирекционог угла, бочна рефракција итд. Стога се бирају одговарајући инструменти и методе мјерења који ће испунити задате критеријуме. На лицу мјеста врши се контрола квалитета серија мјерења. У случају потребе, серије се понављају. У току развијања подземне мреже долази до нагомиланања случајних и систематских грешака мјерења, које утичу на тачност пробоја тунела умањујући је, па је стога неопходно њихово праћење и елиминација из резултата мјерења [8].

Са побољшањем прецизности тоталних станица, све се више користи тригонометријски нивелман за контролу висине. Овдје се истовремено са изравнањем унутрашње мреже у положајном смислу врши и њено висинско изравнање мјерећи вертикалне углове и дужине па се тако добија унутрашња тунелска 3Д мрежа.

Координате привремених тачака унутрашње тунелске мреже у тунелу Мрке, sukcesивно су одређиване заједно са прокопом тунела. Ове тачке се стабилизоване у дијелу гдје је тунел раван на 150 – 250 м а у дијелу гдје је тунел закривљен на око 70 м. Оне су служиле за праћење ископа, постављање ремената, праћење примарне и секундарне облоге као и праћење конвергенције у тунелу. Одређивање координата ових тачака је вршено максимално опрезно са најпрецизнијим инструментима (једносекундне тоталне станице) и мјерењем углова и висинских разлика у бар два гируса.

Приликом пробијања вишетрачних тунела као што је тунел Мрке ситуација са одређивањем координата тачака привремене унутрашње мреже је нешто повољнија него код једнотрачних тунела. Овдје је могуће кроз попречне пролазе који се пробијају на цца 250 м (Слика 7) затворити полигонски влак на тачке спољашње тунелске мреже (Слика 8). На овај начин је могуће изравнати координате унутрашњих тачака и тиме повећати њихову тачност.



Слика 7. Попречна веза у тунелу Мрке

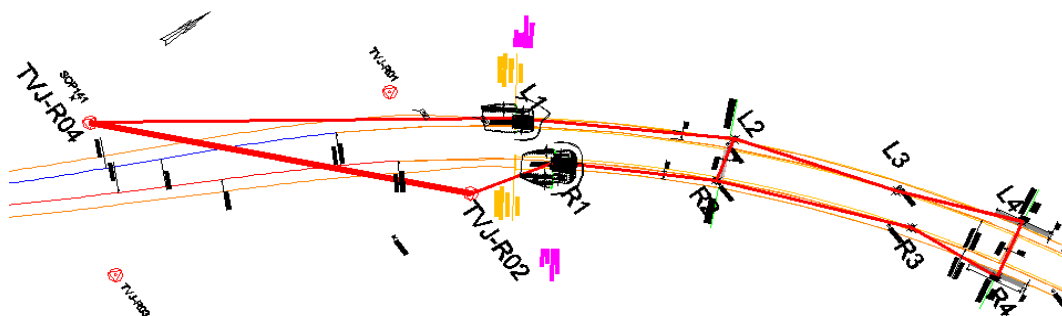

Слика 8. Затворени полигонски влук кроз попречну везу у тунелу

5. РАДОВИ НА ОСМАТРАТРАЊУ И МОНИТОРИНГУ НАТМ

НАТМ методу ископа можемо посматрати као филозофију пројектовања тунела, засновану на следећим концептима:

- Носивост стијенске масе око отвора тунела мобилише се до максимално могућег степена. Пројектант тунела врши претпоставку радијалних помјерања која су очекивана у пресеку тунела и дефинише параметре које је потребно пратити;
- Након ископа се врши уградња елемената примарне подграде у складу са геолошким условима градње. Након тога се врши контрола радијалних деформација и геодетски и геотехнички мониторинг. Контролисањем и праћењем радијалних деформација у тунелу на дефинисаним профилима на дневном нивоу упоређују се резултати са оним које је пројектант тунела предвидио у пројекту. Мјери се укупна величина радијалних деформација као и прираст деформација;
- У случају да параметри које је пројектант дао нису задовољени, повећава се фреквенција мјерења и обавјештава пројектант о резултатима мјерења. Пројектант на основу резултата прописује уградњу додатних елемената подграде и наставља се са мониторингом све док резултати не покажу да је тунел стабилизован;
- Након што је показано да је тунел стабилизован прије него што се настави са радовима на унутрашњој облози потребно је потврдити да су радијалне деформације завршене односно испод нивоа од 4 мм на мјесечном нивоу.

Као што се види из презентоване процедуре, улога геодетских мјерења током ископа НАТМ методом је веома важна, јер је повезана са непосредном безбједношћу људства и опреме инвеститора и извођача радова. У складу са тим, одговорност геодетског инжењера да врши редовна мјерења, повећава фреквенцију мјерења и обавјештава извођача и пројектанта у реалном времену је од највећег значаја.

Раније су се радијалне деформације тунела мјериле прецизним мјерењима дужина на мјерним мјестима помоћу специјалних инструмената (Слика 9).

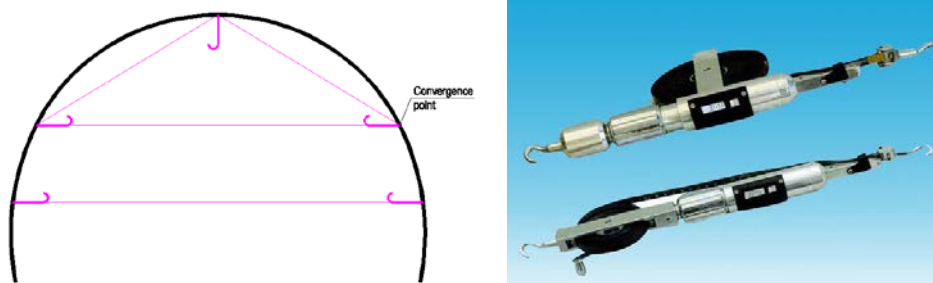

Слика 9. Мјерење радијалних деформација мјерењем дужина

Са унапређењем прецизности тоталних станица мијења се приступ овим мјерењима. Сада се на мјерним мјестима уграђују рефлектори на пројектованим позицијама којима се одређују 3Д координате да би се израчунале конвергенције и помјерања.

Поларне координате рефлектора представљају оригинална читања која дефинишу попречни пресјек. Апсолутне 3Д координате попречног пресека рачунају се са поларним координатама. Сврха 3Д мјерења је:

- верификација геолошких истраживања,
- прилагођавање подграде стварном стању,
- провјера исправности свих подградних мјера [7].

5.1. МОНИТОРИНГ РАДИЈАЛНИХ ДЕФОРМАЦИЈА У ТУНЕЛУ МРКЕ

На тунелу Мрке је ископ вршен НАТМ методом и у даљем тексту су пренешена искуства са овог пројекта. Мјерења су се вршила по унапријед дефинисаним смјерницама датим од стране пројектанта. Секције мјерења су биле дефинисане у зависности од класе стијенске масе у складу са РМР класификацијом и то:

- 1 профил/50 м за II РМР класу околне стијене,
- 1 профил/40 м за III РМР класу околне стијене.

Геотехничким елаборатом су били прогнозирани релативно повољни геотехнички услови у терену који је доминантно састављен од слојевитих до банковитих кречњака РМР класе II и III са мјестимичном појавом расједа. Током извођења радова су установљени доста неповољнији геолошки услови са интензивно испуцалим и карбонизованим кречњацима са глинеом испуном, значајном појавом расједа као и појавом вертикалних канала и пећина без испуне и са глинеом испуном. Након завршетка радова на ископу утврђено је да је 90% стијенске масе било класе III РМР [12] а 10% IV РМР класе.

Лоши геолошки услови су усложнили извођење радова у дијелу пробоја и саме стабилности ископа па је у складу са НАТМ, повећан обим радова на осматрању и мониторингу. Укупан број уграђених профила у тунелу Мрке је 10 за лијеву цијев и 8 за десну.

На подручју гдје су геолошки услови лоши, тест профили су мјерени на краћем интервалу. Веома је важно да се тачке на профили за конвергенцију стабилизују и одреде њихове нулте координате највише 24 h од минирања јер су тада очекивана помјерања највећа.

Рефлектирајућа призма је постављана на носачу од арматуре која је уграђена у торкрет односно стијенски масу (Слика 10). Вођено је рачуна да се елемент не смије постављати на елементе подграде типа анкера или челичних ремената јер мјерења неће бити валидна. Елемент на који се поставља призма мора имати слободан крај на начин да се она са њега може стављати и скидати. Ово је нарочито битно због тога што приликом бушења тунела минирањем ове призме треба привремено скидати са профила блиских челу да исте не би биле уништене. Ако је тачка мјерења оштећена, треба је одмах замијенити бушењем рупе у близини претходне тачке мјерења и поставити арматуру у рупу са малтером. Конвергенција је мјерена на пет мјерних мјеста и то једна, кључна тачка смјештена на круни тунела, двије тачке са стране (средњи дио ископаног простора у првој фази ископавања) и двије тачке смјештене на бочним зидовима (Слика 10).



Слика 10. Рефлектори (призме) за мјерење радијалних помјерања у тунелу Мрке

Фреквенција мјерења се утврђује у зависности од добијених помјерања. У почетку се мјерења врше свакодневно, затим кад дође до постепеног умиривања све рјеђе док се не постигну пројектом предвиђени захтјеви за престанак мјерења радијалних помјерања. При овој методи мјерења, упоредо са мјерењем конвергенције, тј. растојања међу постављеним мјерним тачкама рачуната су и укупна тродимензионална помјерања тачака.

Након што се заврше мјерења, израђују се дијаграми са осама - вријеме и помјерање (Слике 11 и 12) који представљају однос положаја у простору са временом мјерења података.

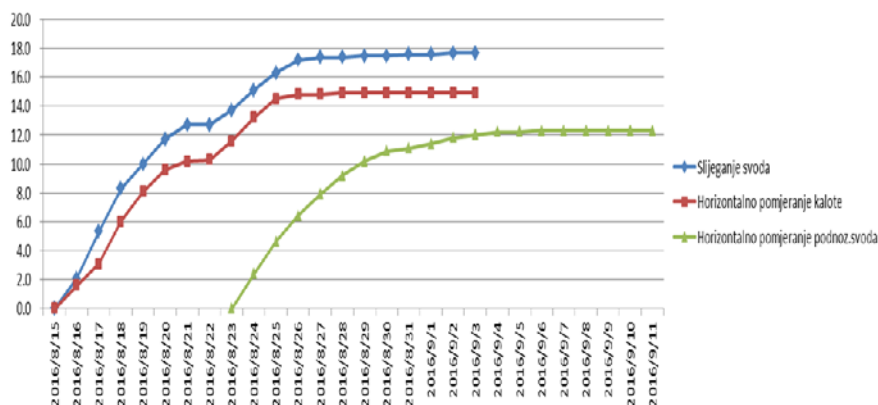

Слика 11. Дијаграм вријеме – помјерање

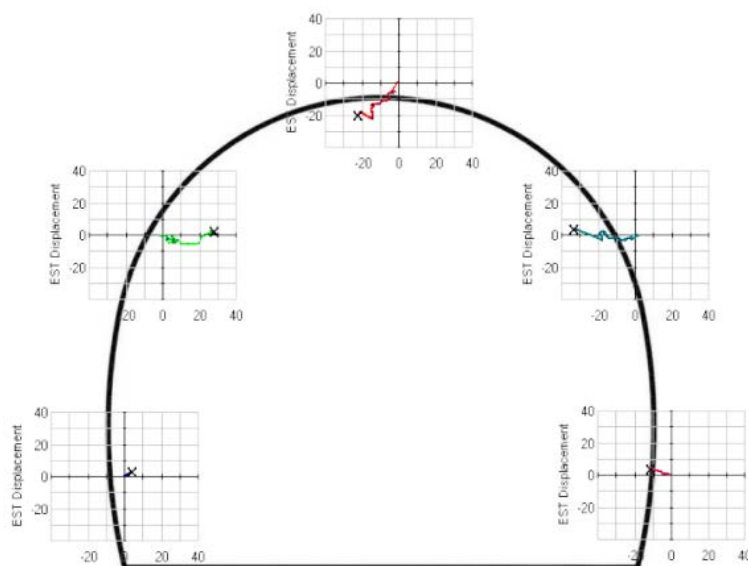

Слика 12. Транслаторно-вертикално помјерање

Конечне референтне вриједности за сваки тип профила који се прати и контролише (а које су дате од стране пројектанта или стручног надзора) и провјерене вриједности се упоређују да би се анализирао опсег и снага обраде и ојачавања. Максимално дозвољене деформације зависе од типа стијене који утврђују геолози и дефинисане су у пројекту. Пројектом тунела Мрке [10], дефинисано да када мјерења покажу да је стопа радијалног измијештања на свакој позицији периферије тунела мања од 4 мм за 30 дана, сматра се да је околна стијена генерално достигла стабилност. У том моменту се демонтирају мјерне тачке и изводе се радови на секундарној облоги.

Пројектом су предвиђене следеће референтне вриједности и ограничења:

- Максимална дозвољена деформација за категорију стијене II је 30 мм, за категорију стијене III је 70 мм, за категорију стијене IV је 120 мм и за категорију стијене V је 150 мм.
- Када је вриједност измјереног помјерања мања од 1/2 вриједности дозвољене деформације, радови се извршавају на нормалан начин;
- Када је вриједност измјереног помјерања већа или једнака 1/2 вриједности, и мања или једнака 2/3 вриједности дозвољена деформација, разматраће се подграда;
- Када је измјерена вриједност помјерања већа од 2/3 вриједности дозвољене деформације, биће предузете посебне мјере;

Како резултати мјерења нијесу прелазиле задате вриједности, и поред геолошког терена неповољнијег од очекиваног, није било потребе за предузимањем посебних мјера и ојачања. С обзиром да се сви подаци снимају, неке конвергентне линије које нису биле значајне у почетку, могу касније да се израчунају. Такође, било која од већ постојећих епоха мерења може да се одабере за нулту епоху у односу на будућа мјерења [9].

6. ЗАКЉУЧАК

Тунел Мрке је један од тунела на дионици аутопута Смоковац Матешево који је имао најповољније геолошке услове за пробијање. Конфигурација околног терена дозволила је стабилизацију надземне геодетске мреже добре геометрије и квалитета. На улазном порталу двије од четири тачке за овај тунел, коришћене су и за мост Горње Мрке који се налази непосредно прије овог тунела. Из квалитетно постављене надземне мреже и вршећи редовне контроле на тачкама подземне мреже а користећи савремене и прецизне тоталне станице могла се очекивати тачност пробоја која ће бити у границама задатих толеранција што се и испоставило као тачно. Начин стабилизације тачака подземне мреже приказан у раду, показао се као адекватан за ову врсту геолошких услова. Редовно пратећи мјерења конвергенције, добијена сажимања стијенске масе била су у границама очекивања у зависности од категорије терена, те није било потребе за додатним ојачањима.

ЛИТЕРАТУРА

- [1] А. Беговић, „Инжењерска геодезија 2“. Београд, Научна књига, 1990.
- [2] Министарство саобраћаја и поморства, China Road and Bridge Corporation, Geo Max group d.o.o., „Главни пројекат геодетске мреже за тунел Мрке“. Podgorica, 2015.
- [3] Д. Димитријевић, „Тунели пројектовање и грађење“. Београд, Завод за издавање уџбеника, 1964.
- [4] Конзорцијум Inter Project-Entasis d.o.o., „Елаборат процјене утицаја Ауто пута на животну средину дионица Смоковац-Матешево“. Подгорица, 2015, pp. 1-646.
- [5] З. Каповић, „Геодезија у нискоградњи“. Загреб, Свеучилиште у Загребу, Геодетски факултет, 2010.
- [6] Ј. Максимовић, З. Сушић, М. Батиловић, Р. Ђуровић, Т. Нинков, „High precision geodetic works in the tunnel breakthrough process“. INDIS, Нови Сад, 2018, pp. 491-496.
- [7] М. Hudec: „Nova Austrijska Tunelska Metoda“. Загреб, Sveučilište u Zagrebu, Rudarsko geološko naftni fakultet, Sveučilišna skripta, 2000.
- [8] М. Савановић, „Прилог развоју методологија израде оптималних пројеката локалних геодетских мрежа метроа“. Докторска дисертација, Факултет техничких наука, Нови Сад, 2017.
- [9] N. Clarke-Hackston, M. Messing, E. Ullrich, „Geodetic Instrumentation for Use on Machine Bored Tunnels“. Zurich, 1st International Conference on Machine Control & Guidance, ETH Zurich, 2008.
- [10] China Road and Bridge Corporation, „Пројекат тунела Мрке“. Подгорица, 2015.
- [11] Ч. Цветковић, „Примена геодезије у инжењерству“. Београд, Грађевинска књига, 1970.
- [12] Bieniawski, Z.T., „Rock Mass Classification in Rock Engineering. In: Bieniawski, Z.T., Ed.“, Symposium Proceedings of Exploration for Rock Engineering, 1, 1976, pp. 97-106.

70

Professional paper I Стручни рад
DOI 10.7251/STP2215709J
ISSN 2566-4484



Vladan Janković, University of Banja Luka, vladan.jankovic@student.aggf.unibl.org

Slavko Vasiljević, University of Banja Luka, slavko.vasiljevic@aggf.unibl.org

Branko Božić, University of Belgrade, bozic@grf.bg.ac.rs

GEODETIC CONTROL OF GEOMETRY OF ENGINEERING FACILITY DURING CONSTRUCTION – CASE STUDY RESIDENTIAL–BUSINESS FACILITY IN SRBAC

Abstract

The paper presents the procedure of geodetic control of the geometry of a residential-business building under construction, by testing the compliance of the position of the designed and constructed characteristic points of the building. It is described the manner of designing and establishing a geodetic network from which the marking and control of geometry was performed. Based on the obtained results, it was concluded that the derived geometry is agreed with designed one. In this way, it was once again confirmed that the establishment of a quality geodetic network, marking and the application of suitable models for testing linear hypotheses play an important role in the successful realization of the projected geometry of the object using geodetic methods.

Keywords: establishing a geodetic network, geodetic control of geometry

ГЕОДЕТСКА КОНТРОЛА ГЕОМЕТРИЈЕ ИНЖЕЊЕРСКОГ ОБЈЕКТА У ТОКУ ИЗГРАДЊЕ – СТУДИЈА СЛУЧАЈА СТАМБЕНО-ПОСЛОВНИ ОБЈЕКАТ У СРПЦУ

Сажетак

У раду је приказан поступак геодетске контроле геометрије стамбено-пословног објекта у изградњи, тестирањем сагласности положаја пројектованих и изведених карактеристичних тачака објекта. Описан је и поступак пројектовања и успостављања геодетске мреже са које је вршено обиљежавање и контрола геометрије. На основу добијених резултата закључено је да је изведена геометрија сагласна пројектованој. На овај начин је још једном потврђено да за успјешно остваривање пројектоване геометрије објекта примјеном геодетских метода важну улогу има успостављање квалитетне геодетске мреже, геодетско обиљежавање и примјена одговарајућих модела за тестирање линеарних хипотеза.

Кључне ријечи: успостављање геодетске мреже, геодетска контрола геометрије

1. УВОД

Један од основних задатака инжењерске геодезије приликом изградње објекта је остваривање пројектоване геометрије објекта на терену, у границама дозвољених одступања. Успјешно рјешавање овог задатка подразумијева геодеетско обиљежавање пројектованих елемената и контролу њихове геометрије у току или након процеса грађења. Обиљежавање и контрола геометрије спроводе се у односу на геодеетску основну мрежу. Она се у току контроле геометрије проширује тачкама на објекту и посматра као контролна мрежа инжењерског објекта.

Квалитет геодеетске мреже је дефинисан прецизношћу, поузданосћу, осјетљивошћу и цијеном реализације [1] [2] [3]. Проблематиком оптимизације геодеетских мрежа и дефинисањем поступака пројектовања геодеетски стручњаци се баве још од 1980-их година [4]. Проблеми пројектовања се могу ријешити коришћењем аналитичких или херуистичких метода [5]. Поступак пројектовања геодеетске мреже, примјеном метода оптимизације [6], се може спровести како је описано у [7] [8] [9].

Геодеетском контролом геометрије се изведена геометрија конструкције упоређује са пројектованом, а може се изводити у 1Д, 2Д или 3Д координатним системима [10]. Упоређивањем се могу провјеравати подударности пројектованих и реализованих геометријских елемената и фигура по положају, облику и величини и облику [11] [12] [13]. Тачност положаја обиљежене тачке условљена је тачношћу положаја тачака основне мреже са које се врши обиљежавање. Она мора бити занемарљива у односу на дозвољено одступање извођења радова. Тачност постојећих геодеетских мрежа често није адекватна за реализацију наведених геодеетских радова. Такође, ни распоред тачака постојећих мрежа није прилагођен потребама обиљежавања будућег објекта. Све претходно наведено доводи до потребе за пројектовањем и реализацијом геодеетске основне мреже која ће испунити поменуте захтјеве. У овом раду је приказано пројектно рјешење геодеетске основне 2Д мреже за потребе геодеетских радова у току изградње стамбено-пословног објекта, са посебним нагласком на најважније резултате добијене у току њене реализације. Кратко је приказана методологија обиљежавања геометрије објекта. Детаљно је описан поступак геодеетске контроле геометрије, односно утврђивања подударности пројектованих и изведених положаја карактеристичних тачака објекта формирањем и тестирањем одговарајућих линеарних хипотеза.

2. ПРОЈЕКАТ ГЕОДЕЕТСКЕ ОСНОВНЕ 2Д МРЕЖЕ

Тачност геодеетске основне 2Д мреже примарно је условљена дозвољеним одступањем извођења радова, а геометрија (распоред тачака и план опажања) обликом и димензијама објекта, карактеристикама терена, организацијом градилишта и технологијом извођења радова [9]. У геодеетској пракси на овим просторима најважнији елементи пројекта геодеетске мреже се приказују у форми техничког извјештаја.

2.1. ОСНОВНИ ПОДАЦИ О ИНЖЕЊЕРСКОМ ОБЈЕКТУ И КОНСТРУКЦИЈИ

У центру општине Србац предвиђена је изградња стамбено-пословног објекта (слика 1). Пројекат конструкције је израђен према ЈУС и РВАВ-87 правилницима и стандардима за грађевинске конструкције. Објекат је у основи неправилног облика габаритних димензија приземља 30.46 m x 14.20 m и спратова 33.39 m x 14.70 m. Спратност објекта је П + 4, са укупном висином 15.20 m. Вертикална конструкција објекта је пројектована као комбинација армиранобетонских стубова и платана (зидова). Међуспратне конструкције су монолитне армиранобетонске плоче дебљине $d = 15$ cm у систему са АБ гредама у оба правца, различитих димензија у зависности од распона и нивоа оптерећења. Пројектом дефинисано дозвољено одступање извођења радова је 2 cm. Ова величина представља улазни податак за пројектовање геодеетске основне 2Д мреже.



Слика 1. Позиција и 3Д модел објекта

2.2. ПРОЈЕКТНО РЈЕШЕЊЕ ГЕОДЕТСКЕ ОСНОВНЕ 2Д МРЕЖЕ

Да би се извршило успјешно пројектовање основне 2Д мреже неопходно је пратити алгоритам пројектовања приказан на слици 2.

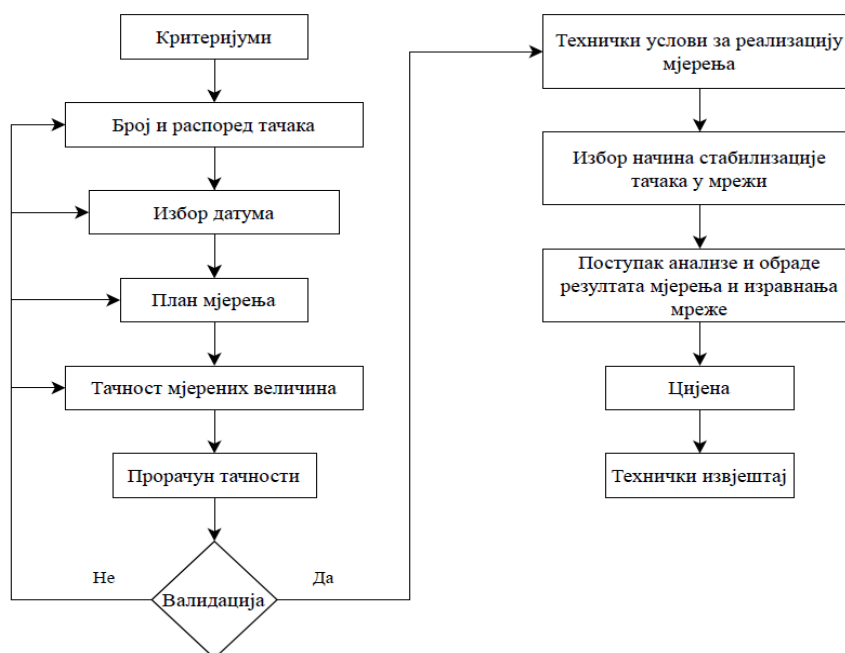

Слика 2. Алгоритам пројектовања 2Д мреже [1] [9]

На основу дозвољеног одступања примјеном принципа занемарљивости, изведена је положајна тачност карактеристичних тачака објекта које се обиљежавају, у износу 3.3 mm, док положајна тачност тачака основне мреже треба бити већа или једнака 1.1 mm.

Остали критеријуми који морају бити испуњени приликом пројектовања геодетске основне 2Д мреже су следећи:

- Однос велике и мале полуосе стандардних елипси грешака не смије бити већи од 2:1;
- Локална мјера унутрашње поузданости треба бити већа од 0.3; и
- Маргинална груба грешка која се тестом присуства грубих грешака може открити треба бити мања од $7\sigma_i$ [9].

Приликом планирања распореда тачака у мрежи треба водити рачуна о следећим захтјевима:

- Свака тачка мреже треба да се догледа са минимум двије сусједне тачке мреже;

- За сваку тачку објекта мора да се омогући обиљежавање са минимум двије тачке мреже;
- Тачке основне мреже постављају се на стабилном терену;
- Тачке основне мреже морају увијек бити доступне и мора се обезбједити да не буду уништене током изградње објекта за шта је неопходно познавати организацију градилишта;
- Високо тачно обиљежавање тачке изводи се са минимум три тачке основне мреже [9].

Код високих објеката треба водити рачуна да су тачке мреже удаљене од објекта минимално за вриједност висине објекта, а по могућности и више.

Поштујући претходно наведене захтјеве одређено је да број тачака основне мреже буде 5. Координатни систем основне 2Д мреже је локални координатни систем, а датум мреже је одређен приближним координатама свих тачака (минимални траг) [14].

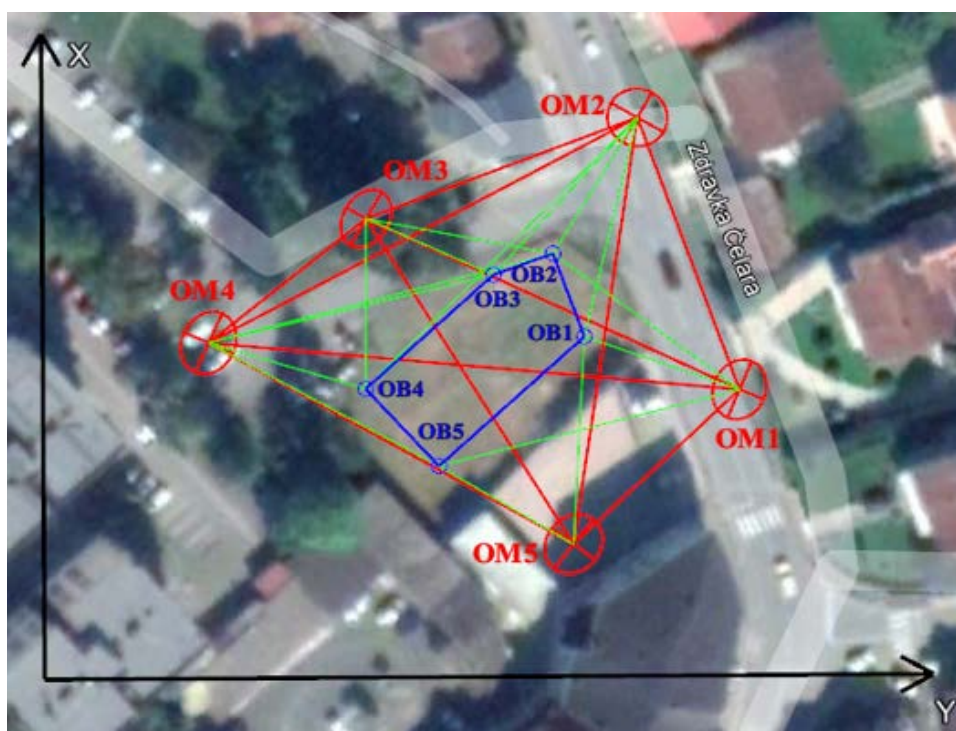

Слика 3. Распоред тачака основне 2Д мреже

Планом мјерења предвиђено је мјерење праваца и дужина, а укупан број мјерења износи 30. Тачност мјерења дефинисана је на основу познатог стандардног одступања положаја тачака основне мреже. У зависности од дужине визуре, стандардно одступање мјерења праваца је у интервалу од 5" до 9", а стандардно одступање мјерења дужина износи 2.2 mm.

Након избора положаја тачака и плана мерења дефинисани су елементи функционалног модела на основу чега је извршен прорачун тачности и одређене мјере прецизности и поузданости [14].

Вриједности добијене прорачуном су приказане у Табели 1 и 2.

Табела 1. Критеријуми прецизности

Критеријум прецизности	Минимум	Максимум
Стандардно одступање по у-оси [mm]	0.6	0.7
Стандардно одступање по х-оси [mm]	0.5	0.7
Стандардно одступање по положају [mm]	0.9	1.0
Однос велике и мале полуосе елипсе грешака	1.04	1.34

Табела 2. Критеријуми поузданости

Критеријум поузданости	Правци	Дужине
Локална мјера унутрашње поузданости	0.4 - 0.6	0.7 - 0.8
Маргинална груба грешка	21.7 - 38.3	6.9 - 7.3

Након прорачуна тачности, поређењем задатих критеријума са вриједностима добијеним из прорачуна тачности изведена је валидација пројекта. Валидацијом је утврђено да су све вриједности у дозвољеним границама на основу чега је пројекат основне 2Д мреже усвојен, те је приступљено дефинисању техничких услова за реализацију мјерења.

За мјерења у мрежи неопходан је инструмент са стандардном мјерења праваца $\sigma_r \leq 5''$ и стандардом мјерења дужина од $\sigma_D = 2 \text{ mm} + 2 \text{ ppm}$. Правци се мјере гирусном методом у два гируса, а дужине обострано. Пројектом је предвиђен начин стабилизација тачака и дефинисани су параметри за праћење и контролу мјерења праваца и дужина. Изравнање резултата мјерења и оцјена координата тачака основне 2Д мреже извршени су методом најмањих квадрата.

3. ГЕОДЕТСКО ОБИЉЕЖАВАЊЕ И КОНТРОЛА ГЕОМЕТРИЈЕ ОБЈЕКТА

Обиљежавање тачака на терену може се обавити неком од следећих метода: поларном методом, ортогоналном методом, лучним пресјеком, пресијецањем праваца напријед, директним пресјеком праваца, методом слободног позиционирања или ГНСС методом [15]. Обиљежавање карактеристичних тачака објекта извршено је полораном методом у једном положају дурбина (обиљежавање обичном тачношћу) у складу са условима дефинисаним у пројекту обиљежавања.

Током изградње објекта вршена је контрола геометрије по положају за 5 карактеристичних тачака објекта, по свакој етажи.

Приликом тестирања по положају, тест хипотезе гласе:

- H_0 : Координате тачака на терену које дискретизују објекат су сагласне пројектованим;
- H_a : Координате тачака на терену које дискретизују објекат нису сагласне пројектованим.

Нулта и алтернативна хипотеза се могу записати у следећем облику:

$$H_0: M(d) = 0 \quad (1)$$

$$H_a: M(d) \neq 0 \quad (2)$$

гдје је d – вектор разлика оцијењених и пројектованих координата, облика:

$$d = \begin{bmatrix} \hat{Y}_1 - Y_{1\text{proj}} \\ \hat{X}_1 - X_{1\text{proj}} \\ \vdots \\ \hat{Y}_5 - Y_{5\text{proj}} \\ \hat{X}_5 - X_{5\text{proj}} \end{bmatrix} \quad (3)$$

Сваки члан вектора d представља једну функционалну једначину којом се успоставља однос између оцијењених и пројектованих координата, облика:

$$f_1 = \hat{Y}_1 - Y_{1\text{proj}} \quad (4)$$

Матрица H садржи изводе функционалних једначина по непознатим параметрима, облика:

$$H = \begin{bmatrix} \frac{\partial f_1}{\partial \hat{Y}_1} & \frac{\partial f_1}{\partial \hat{X}_1} & \dots & \frac{\partial f_1}{\partial \hat{Y}_5} & \frac{\partial f_1}{\partial \hat{X}_5} \\ \vdots & \vdots & \dots & \vdots & \vdots \\ \frac{\partial f_{10}}{\partial \hat{Y}_1} & \frac{\partial f_{10}}{\partial \hat{X}_1} & \dots & \frac{\partial f_{10}}{\partial \hat{Y}_5} & \frac{\partial f_{10}}{\partial \hat{X}_5} \end{bmatrix} \quad (5)$$

Припадајућа кофакторска матрица се рачуна према следећем изразу:

$$Q_d = H Q_{\hat{x}} H^T \quad (6)$$

гдје је $Q_{\hat{x}}$ – кофакторска матрица оцјена непознатих параметара (из изравнања контролне мреже).

Тестирање нулте хипотезе изведено је коришћењем тест статистике, облика:

$$T = \frac{d^T Q_d^{-1} d}{k \cdot \sigma_0^2} \sim F_{1-\frac{\alpha}{2}, k, \infty} \quad (7)$$

гдје је:

k – ранг матрице H ,

σ_0 – а приори фактор варијансе,

F – квантил Фишерове расподеле за дати ниво значајности и број степени слободe.

4. ПОСТИГНУТИ РЕЗУЛТАТИ

4.1. ИЗРАВНАЊЕ ОСНОВНЕ 2Д МРЕЖЕ

У току реализације мреже поштујући критеријуме за праћење и контролу мјерења остварена је тачност мјерења праваца и дужина предвиђена пројектом.

У мрежи је извршено 30 мјерења, од чега 20 праваца и 10 дужина. Правци су мјерени са свих 5 тачака основне мреже. За σ а приори је усвојена вриједност 1, док оцијењена вриједност износи 1.24. Глобални тест адекватности модела није показао присуство грубих грешака. Вриједност теста нулте хипотезе износи 1.53, док је дозвољена вриједност 1.60.

Табела 2. Оцијењена стандардна одступања тачака основне мреже

Тачка	σ_y [mm]	σ_x [mm]	σ_p [mm]
ОМ1	0.5	0.5	0.8
ОМ2	0.5	0.6	0.8
ОМ3	0.6	0.4	0.7
ОМ4	0.7	0.5	0.8
ОМ5	0.5	0.6	0.8

4.2. КОНТРОЛА ГЕОМЕТРИЈЕ

Контрола сагласности изведеног објекта са пројектованим реализована је ослањајући се на 5 тачака основне 2Д мреже и обухватила је 5 тачака на објекту. Датум је дефинисан тачкама основне мреже. Извршено је 43 мјерења, од чега 28 праваца и 15 дужина. Геодетска контрола геометрије проведена је независно за сваку етажу, а приказана је за прву и последњу.

Табела 3. Разлике оцијењених и пројектованих координата

Координата тачке	Прва етажа [mm]	Последња етажа [mm]
YOB1	1.5	0.1
XOB1	-0.5	-0.2
YOB2	-0.2	1.1
XOB2	-0.3	-0.3
YOB3	-0.6	2.0
XOB3	-0.3	0.2
YOB4	0.4	0.9
XOB4	-0.6	-0.7
YOB5	-2.5	1.2
XOB5	1.2	-0.8

Добијене вриједности тест статистике приликом тестирања постављених хипотеза за прву и последњу етажу износе 1.97 и 1.70, док је дозвољена вриједност 2.05. Упоредјујући оцијењене положаје тачака објекта са њиховим пројектованим положајима, тестирањем је констатована њихова потпуна сагласност.

5. ЗАКЉУЧАК

Приликом пројектовања геодетских мрежа морају се испунити задати критеријуми који се односе на прецизност и поузданост. Такође, треба водити рачуна и о економичности како не би дошло до непотребног поскупљења радова. Према томе, геодета мора пронаћи оптимално, односно најбоље пројектно рјешење мреже за потребе изградње будућег објекта.

У пројектовању основне мреже за обиљежавање и контролу геометрије објекта прецизно су дефинисани кораци у испуњавању улазних критеријума. Валидацијом пројектног рјешења потврђено је да су сви резултати у дозвољеним границама.

Контрола геометрије је показала сагласност изведене и пројектоване геометрије објекта, односно, разлике координата нису значајне, те је закључено да је пројектована геометрија објекта пренијета на терен у дозвољеним границама.

This article was prepared under the Erasmus+ project "Business driven problem-based learning for academic excellence in geoinformatics - GEOBIZ". The project has been funded with support from the European Commission. This publication reflects the views only of the authors, and the Commission cannot be held responsible for any use which may be made of the information contained therein.

ЛИТЕРАТУРА:

- [1] Б. Миловановић, С. Васиљевић, П. Вранић, „Пројектовање и реализација контролне мреже телекомуникационог торња Авала“, *Техника*, 74(6), стр. 703-708, 2020.
- [2] A. R. Amiri-Simkooei, "Comparison of reliability and geometrical strength criteria in geodetic networks", In *Journal of Geodesy*, 75, pp. 227-233, 2001.
- [3] W. F. Caspary, "Concepts of Networks and Deformation Analysis", Monograph 11, School of Surveying, The University of New South Wales, Kensington, Australia, 1988.
- [4] E. W. Grafarend, F. Sanso, eds. *Optimization and design of geodetic networks*, Springer, Berlin, 1985.
- [5] A. R. Amiri-Simkooei, F. Zengeneh-Nejad, J. Asagri, S. Zanimpardaz, "Basic Concepts of Optimization and Design of Geodetic Networks", In *Journal of Surveying Engineering*, pp. 138. 172-183, 2012.
- [6] К. Михаиловић, И. Алексић, *Концепти мрежа у геодетском премеру*. Београд: Геокарта, 2008.
- [7] B. Milovanović, "Designing the Control Networks for Hydrotechnical Objects for the Purpose of Geodetic Monitoring", In *International Symposium on Engineering Geodesy SIG 2016 – Proceedings, Croatian Geodetic Society*, pp. 71-82, 2016.
- [8] S. Vasiljević, B. Milovanović, Z. Gospavić, "Innovated Project of Geodetic Monitoring of "Воџас" Dam", In *International Symposium on Engineering Geodesy SIG 2016 – Proceedings, Croatian Geodetic Society*, pp. 189-199, 2016.
- [9] Б. Миловановић, З. Госпавић, М. Пејовић, С. Васиљевић, „Пројекат основне мреже“, *Зборник радова Националног научног скупа-ГЕО*, стр. 3-11, 2014.
- [10] З. Госпавић, С. Ашанин, Б. Миловановић, М. Пејовић, „Контрола геометрије инжењерских објеката геодетским методама“, *Грађевински календар*, 45, стр. 246-272, 2013.
- [11] С. Ашанин, *Инжењерска геодезија 1*. Београд: Агео, 2003.
- [12] З. Госпавић, *Методологија контроле геометрије инжењерских објеката* [Магистарски рад], Универзитет у Београду, Грађевински факултет, Београд, 1995.
- [13] С. Ашанин, С. Панџић, З. Госпавић, Б. Миловановић, *Збирка одабраних задатака из инжењерске геодезије*. Београд: Геокарта, 2007.
- [14] Б. Божић, *Рачун изравнања – напредни ниво*, Скрипта, Грађевински факултет у Београду, Београд, 2012.
- [15] А. Беговић, З. Госпавић, *Инжењерска геодезија 1*. Београд: Грађевински факултет, Универзитет у Београду, 2016.

 CAREQILL
by LANACO byLANACO EDUIS eVisitor SOHO

HOTEL SOFTWARE by LANACO

 Spaceify STATION 24 YoUCC

Kompanija **Lanaco** je najveća privatna IT kompanija u BiH, koja posluje od 1990. godine, a trenutno broji preko 350 zaposlenih sa tendencijom rasta. Sjedište kompanije je Lanaco Tehnološki centar u Banjoj Luci sa poslovnim jedinicama u Sarajevu, Beogradu i Novom Sadu. Kompanija kreira sopstvena aplikativna softverska rješenja koja implementira u javnom i privatnom sektoru u BiH, Srbiji i Crnoj Gori, Nigeriji i Pakistanu.

Kvalitet poslovanja kompanije Lanaco potvrđen je i od strane globalnih IT kompanija, kao što su: Microsoft, Oracle, Cisco, SAP, HP, Fujitsu, Fortinet, EMC, Intel, VMware, Kaspersky, Kyocera i drugih.

Gledajući širu sliku i jasne ciljeve, a nikada ne gubeći iz vida detalje naše misije i vizije, kompanija Lanaco je prešla put dug tri decenije, i na tom putu izgradila jake partnerske odnose sa vendorima i klijentima iz različitih industrija.

Kao privredno društvo kome je djelatnost razvoj visoko sofisticiranih proizvoda u oblasti informacionih tehnologija, Lanaco ima posebnu obavezu i privilegiju da nastupa otvoreno, društveno odgovorno, iskreno i sa integritetom u pogledu cjelokupnog poslovnog ponašanja prema zaposlenima, kupcima, dobavljačima i konkurentima. Opasnosti koje realno postoje u vezi sa primjenom proizvoda informacionih tehnologija u pogledu zaštite osnovnih ljudskih prava posebno obavezuje kompaniju Lanaco da u skladu sa etičkim principima, preuzme odgovornost koja bi obezbijedila njihovu zaštitu u skladu sa proklamovanim društvenim vrijednostima. Lanaco posebnu pažnju posvećuje edukaciji svojih zaposlenih o etičkom poslovanju. Svoje zaposlene podstičemo na stalna usavršavanja i na kontinuiranu edukaciju. Zaposleni kompanije Lanaco učestvuju na svjetskim konferencijama, obukama i seminarima na kojima svoja znanja i kompetencije konstantno proširuju, ali i dijele.

Pod jednim krovom ujedinili smo razvoj softvera, hardvera, telekomunikacije, sistemsku integraciju i posvetili se edukaciji mladih ljudi. Kroz konstruktivnu energiju, strast za tehnologijom i razumijevanje istinskih potreba naših klijenata kreiramo proizvode i rješenja koja čine razliku i daju dodatnu vrijednost.

Lanaco Tehnološki centar posjeduje Data centar, koji je jedini definisanog Tier 4 nivoa u BiH. Data centar nam omogućava da pružamo Cloud usluge koje za krajnji cilj imaju smanjeno investiranja u hardverske komponente, što ujedno smanjuje otpad i troškove.

Naša misija je biti i ostati IT lider prepoznat po zaokruženoj ponudi, od hardvera, preko aplikativnog softvera i telekomunikacija, do sistema integracije svih IKT komponenti u efikasne, fleksibilne i pouzdane kompleksne informacione sisteme namijenjene različitim segmentima regionalnog tržišta.

Lanaco je kompanija koja kreira inovativna rješenja bazirana na korišćenju tehnologije posljednje generacije, koja se u potpunosti prilagođava potrebama i zahtjevima krajnjeg korisnika, čije je finalno zadovoljstvo najvažniji kriterijum uspjeha za kompaniju Lanaco.

An aerial view of a city with a blue color overlay. The image features a grid of streets, several tall skyscrapers, and a river. Overlaid on the city are several thin, light blue lines that form a network of arcs and circles, suggesting connectivity or data flow. The overall aesthetic is modern and technological.

LANACO

www.lanaco.com

Mi gradimo
BUDUĆNOST!



INTEGRAL
INŽENJERING a.d.

Omladinska 44, 78250 Laktaši 

+387 (0)51 337 401 

+387 (0)51 337 491 

iicbl@integralgrupa.com 



www.integralinzenjering.com

CIP - Каталогизација у публикацији
Народна и универзитетска библиотека
Републике Српске, Бања Лука

69:71/72(082)(0.034.2)
624(082)(0.034.2)

INTERNATIONAL Conference on Contemporary Theory and Practice in Construction XV Stepgrad XV (15 ; 2022 ; Banja Luka)
Proceedings [Електронски извор] = Зборник радова / International Conference on Contemporary Theory and Practice in Construction XV Stepgrad XV, Banja Luka, June 16-17, 2022 = Међународна конференција Савремена теорија и пракса у градитељству XV Степград XV, Бања Лука, 16-17.06.2022. ; [Editors, уредници Snježana Maksimović, Sandra Kosić-Jeremić]. - Onlajn izd. - El. zbornik. - Banja Luka : University of Banja Luka Faculty of Architecture, Civil Engineering and Geodesy = Универзитет у Бањој Луци, Архитектонско-грађевинско-геодетски факултет, 2022. - (Savremena teorija i praksa u graditeljstvu, ISSN 2566-4484)

Sistemski zahtjevi nisu navedeni. - Način pristupa (URL): <https://stepgrad.aggf.unibl.org/>. - Nasl. sa nasl. ekrana. - Opis izvora дана 10. 6. 2022. - Bibliografija uz sve radove.

ISBN 978-99976-978-4-4

COBISS.RS-ID 136348161

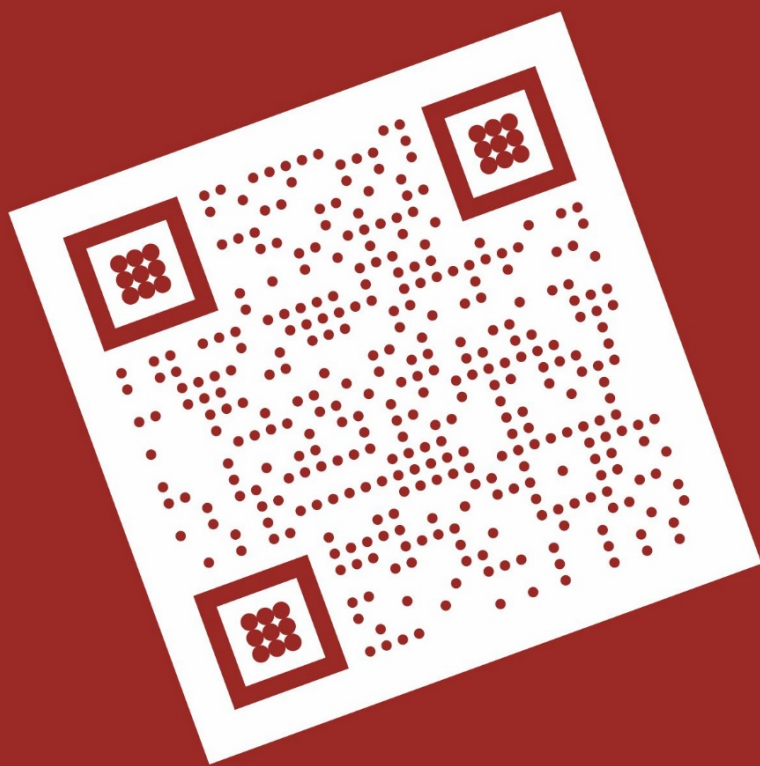

УНИВЕРЗИТЕТ У БАЊОЈ ЛУЦИ
UNIVERSITY OF BANJA LUKA
АРХИТЕКТОНСКО-ГРАЂЕВИНСКО-ГЕОДЕТСКИ ФАКУЛТЕТ
FACULTY OF ARCHITECTURE, CIVIL ENGINEERING AND GEODESY

