

II A 286

37 78

231

N 37

С Л И К Е

К УПУТСТВУ



ЗА

ГРАЂЕЊЕ ГВОЗДЕНИХ ПУТОВА

ОД

МИХ. ПЕТРОВИЋА

ПРОФ. БЕЛ. ШКОЛЕ

У XXVIII ТАБЛИЦА

У БЕОГРАДУ 1875

ШТАМПА И ИЗДАЊЕ ДРЖАВНЕ ШТАМПARIЈЕ

Цена 3 динара

Сл. 1.

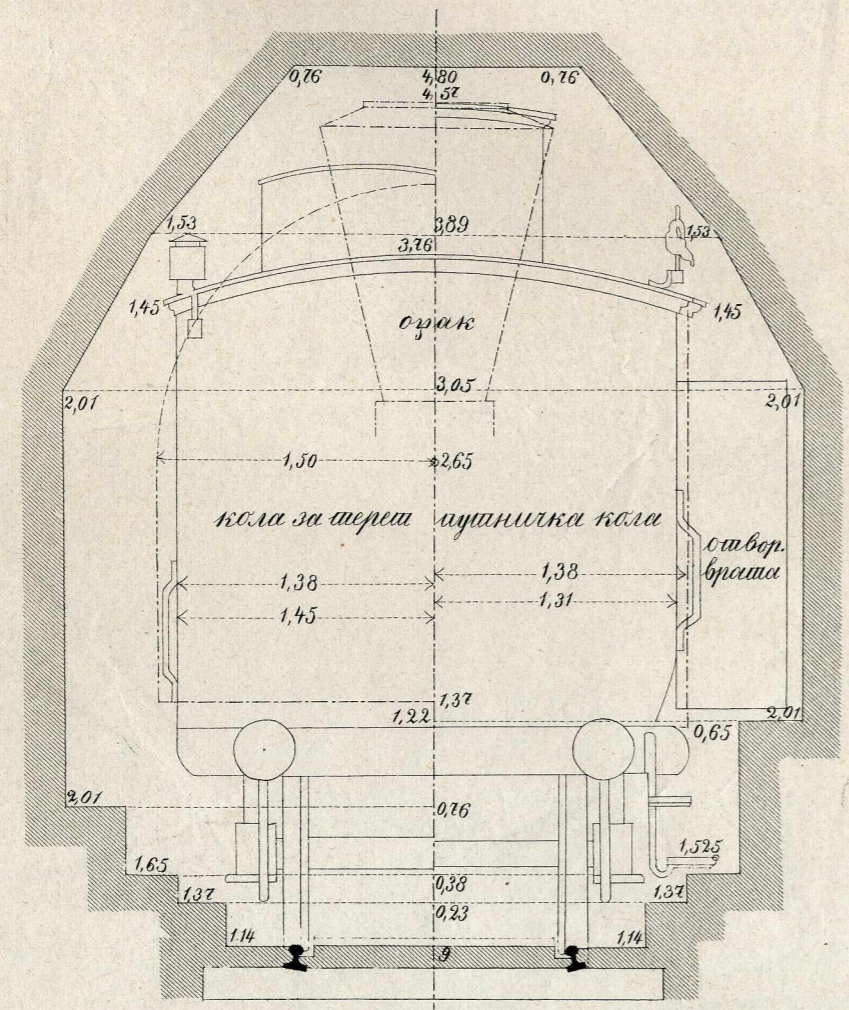

Сл. 2.

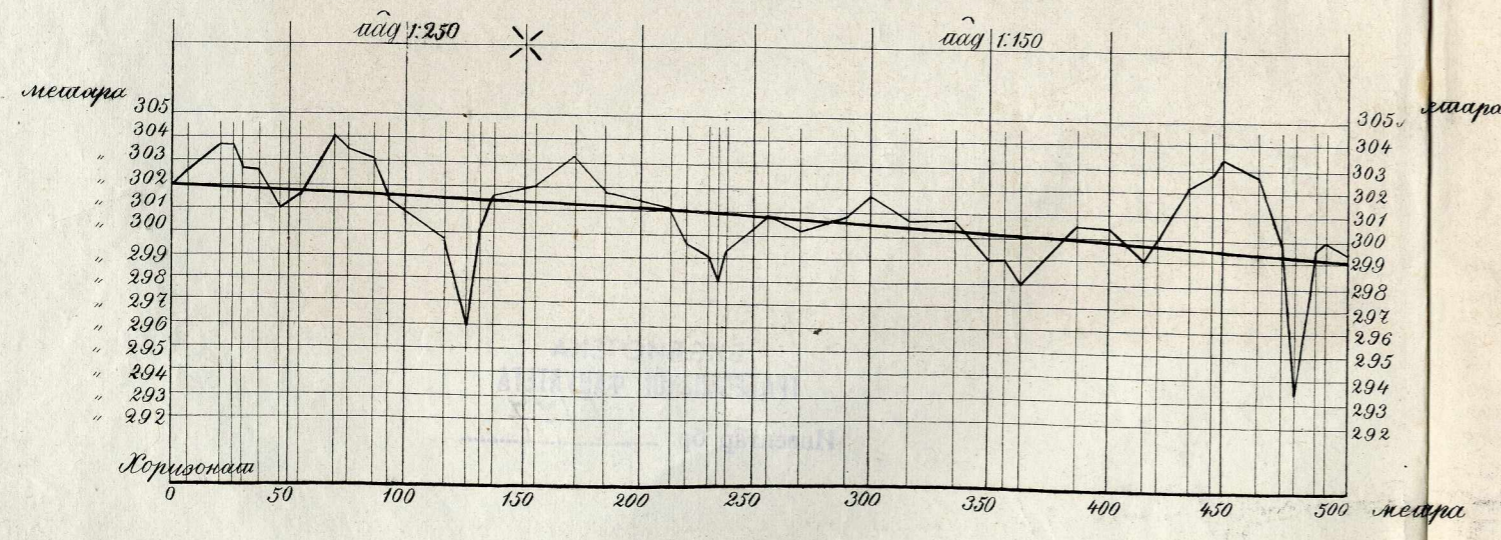

Сл. 3.

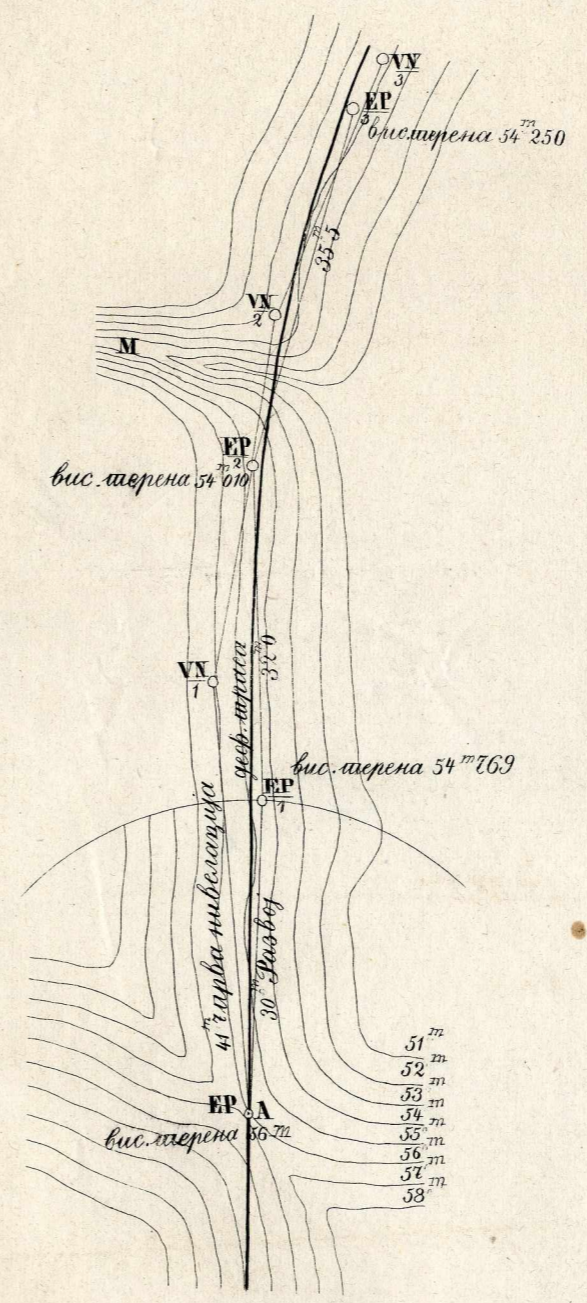

Сл. 4.

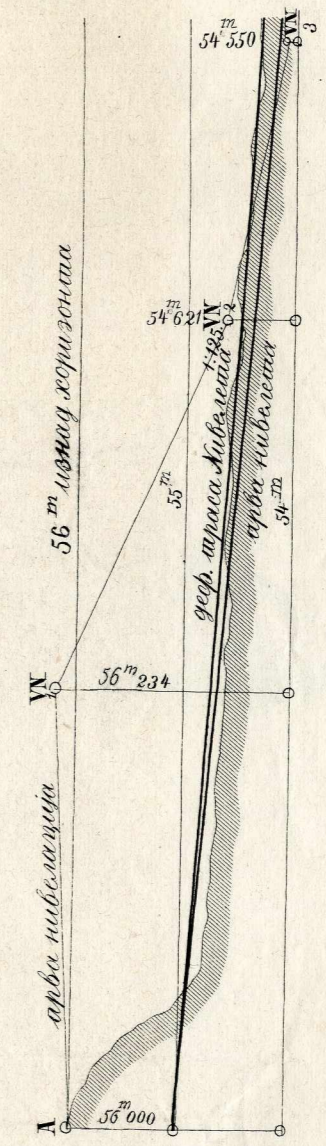

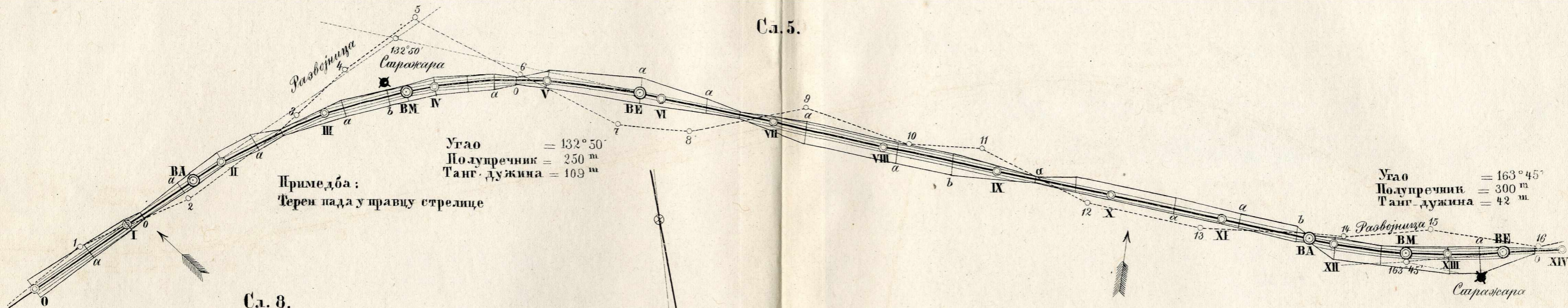

Сл. 5.

Сл. 8.

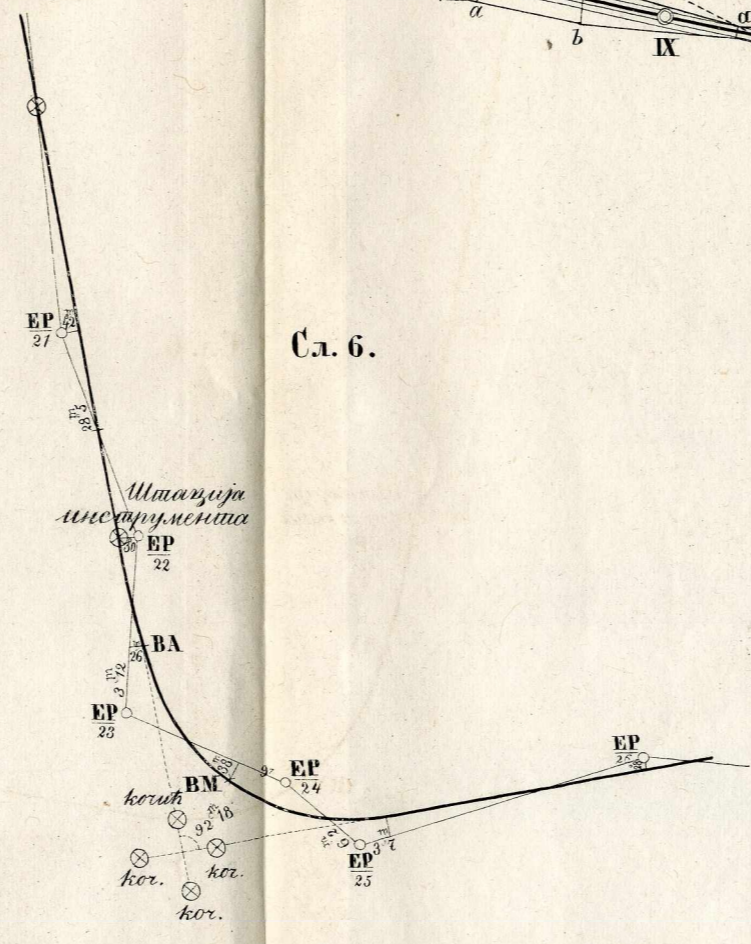
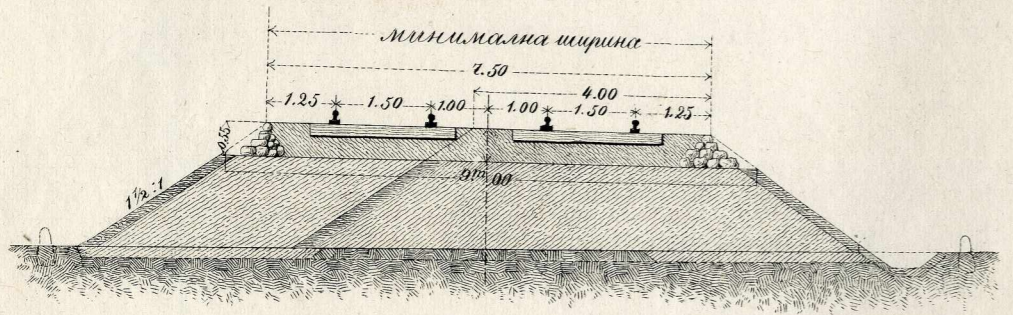

Сл. 6.

Сл. 9.

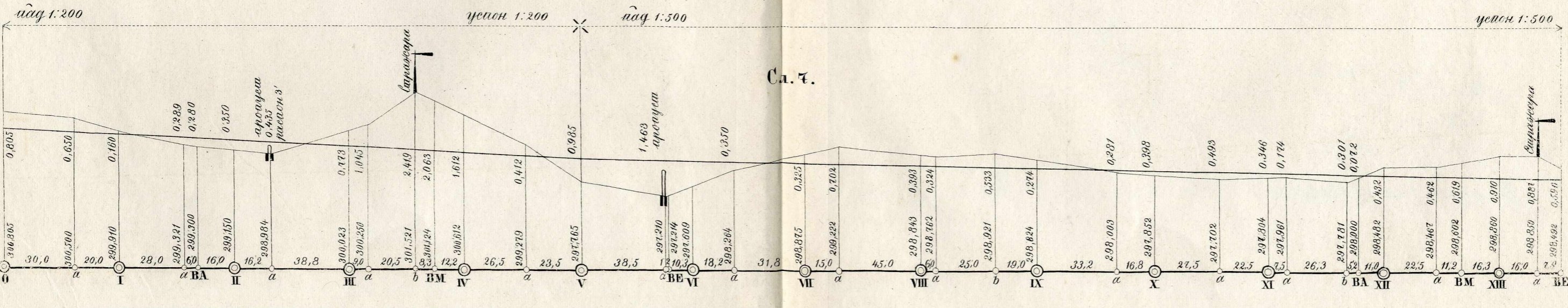
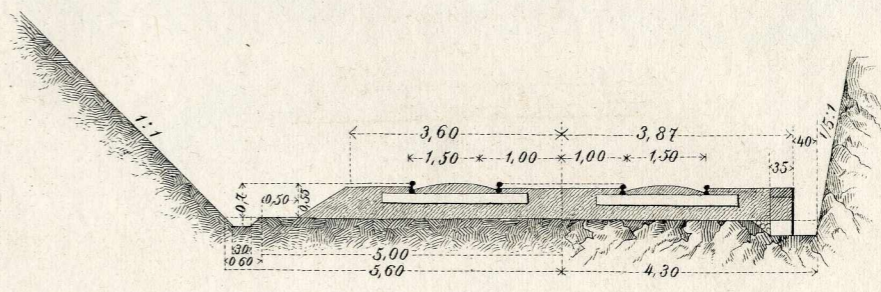

Сл. 7.

Сл. 10.



Сл. 11.

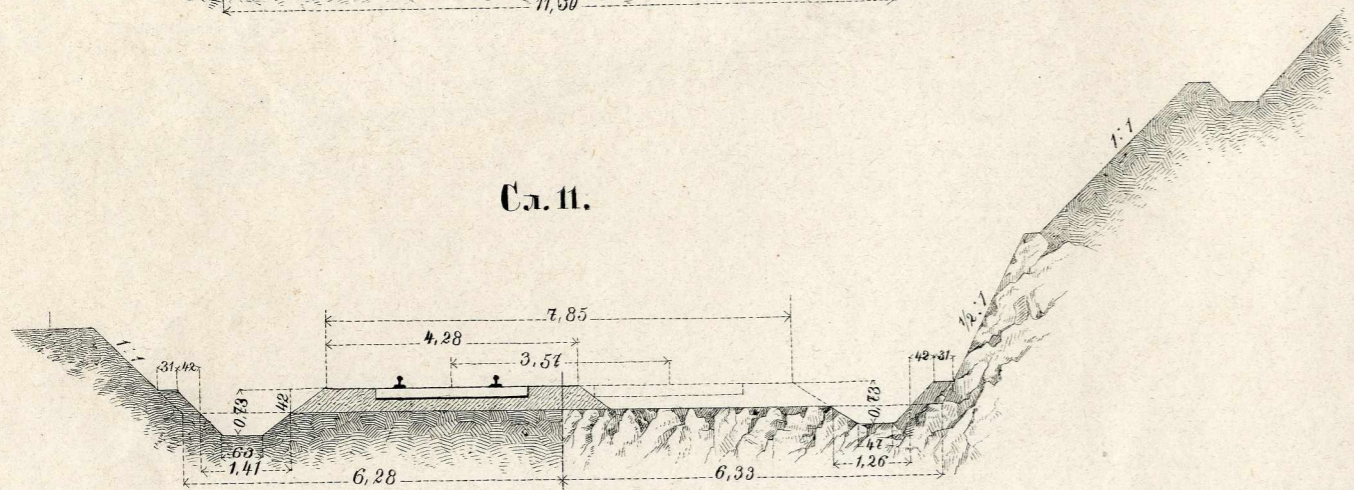

Сл. 12.

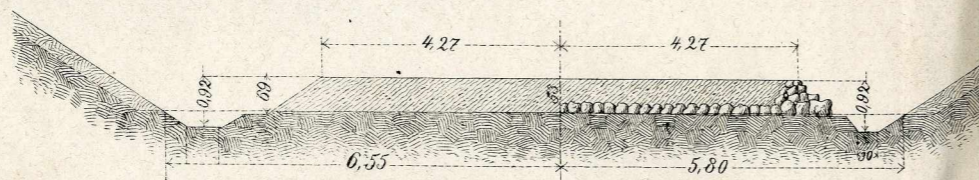

Сл. 15.

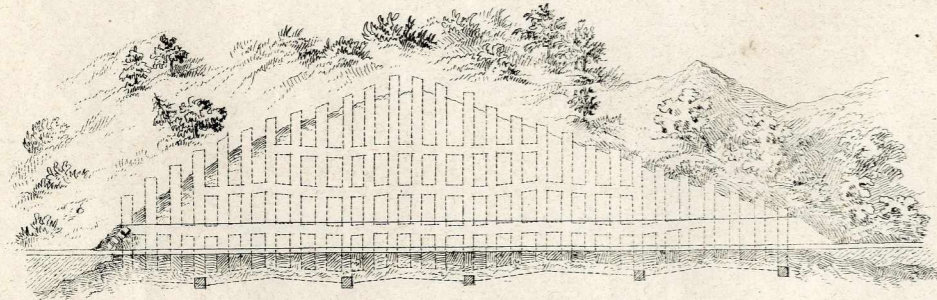

Сл. 16.

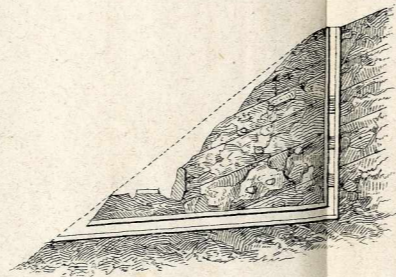

Сл. 17.

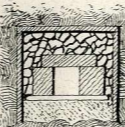

Сл. 18.

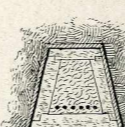

Сл. 19.

Сл. 14.

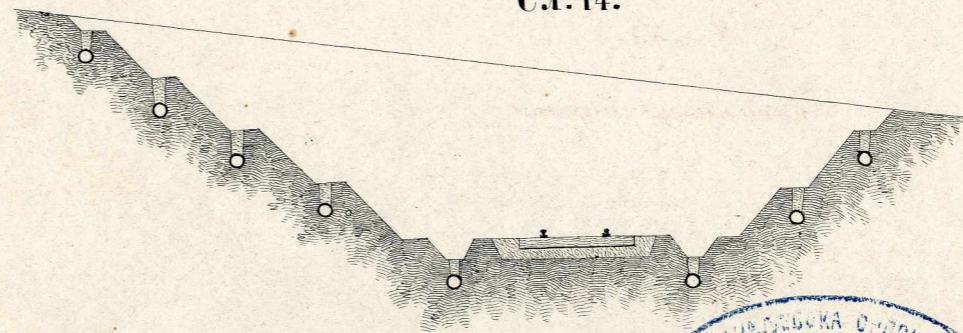

Сл. 13.

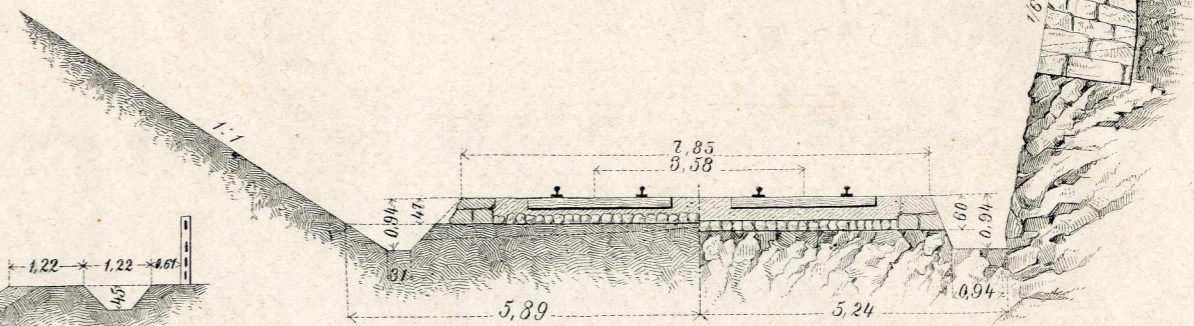

Сл. 20.

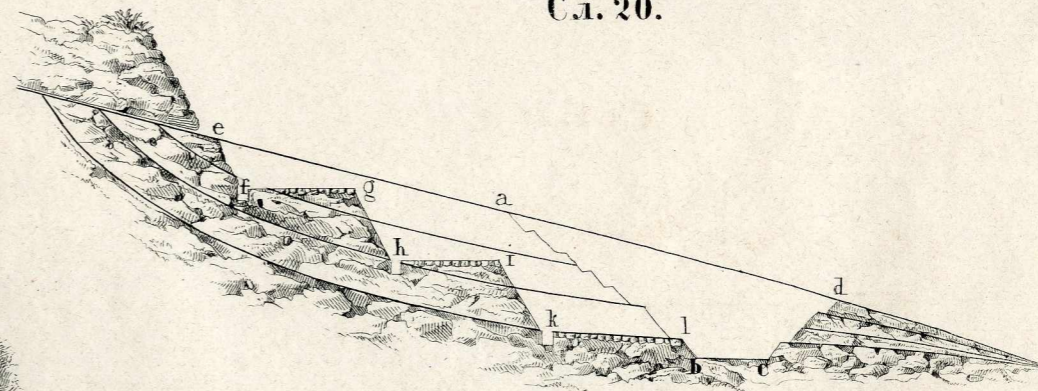

КРОЈИЛАЦ
 ВЕЛИКАТРОНА
 ИНЖЕНЕР КРИШТИЈА
 БЕОГРАД

Сл. 21.

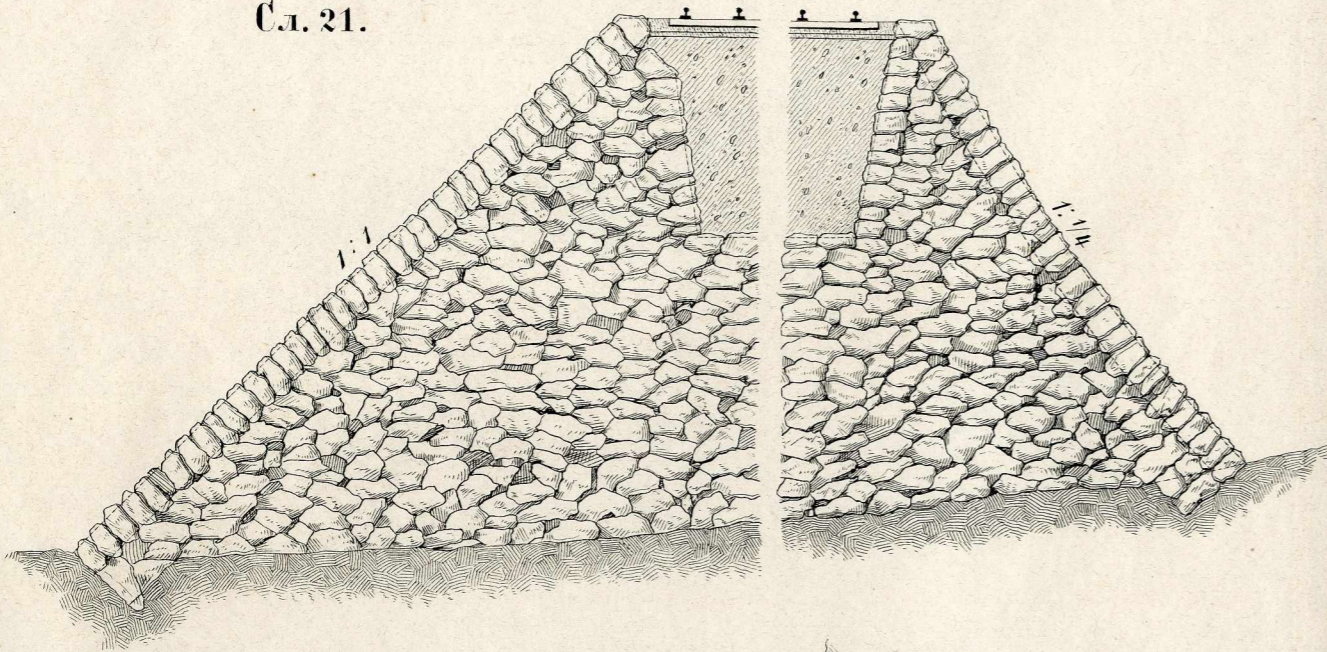

Сл. 22.

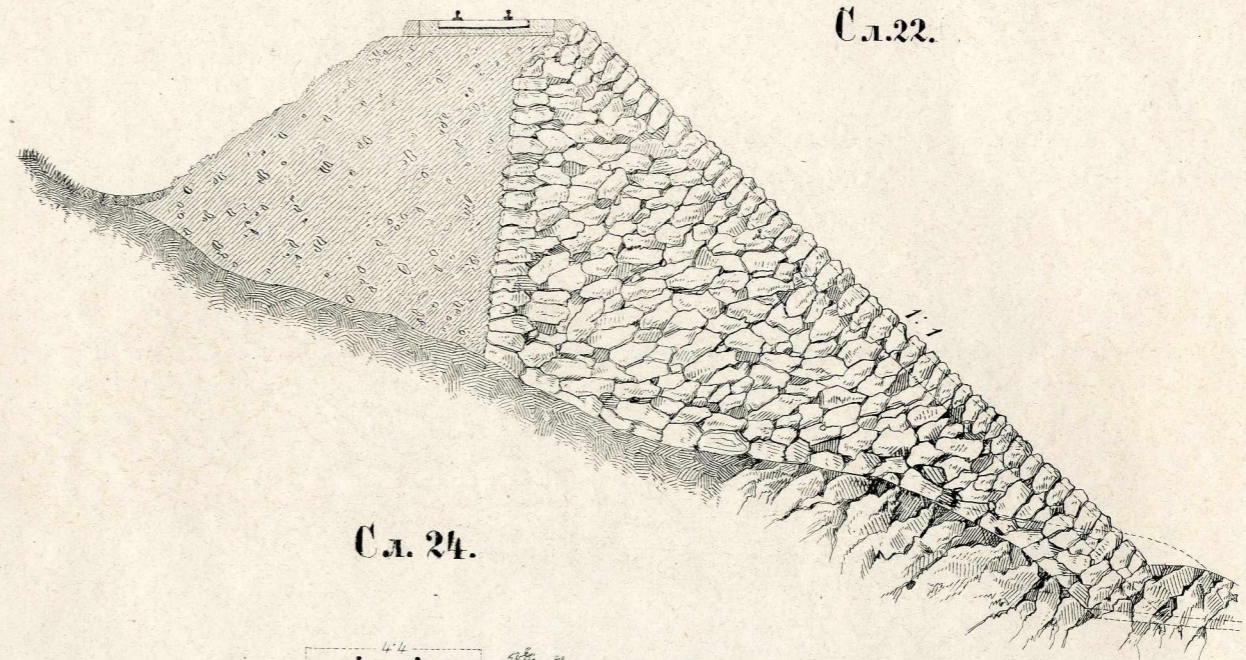

Сл. 23.

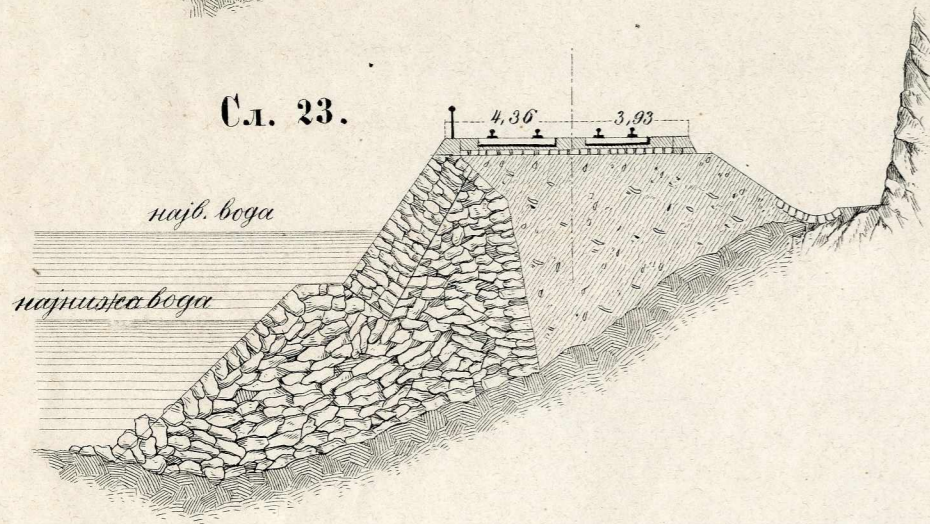

Сл. 28.

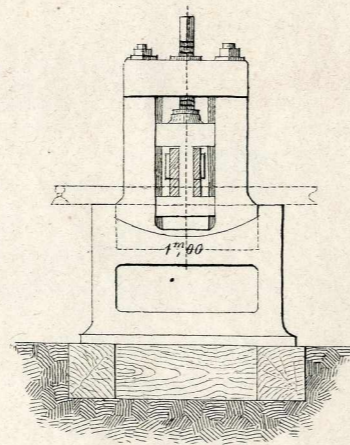

Сл. 24.

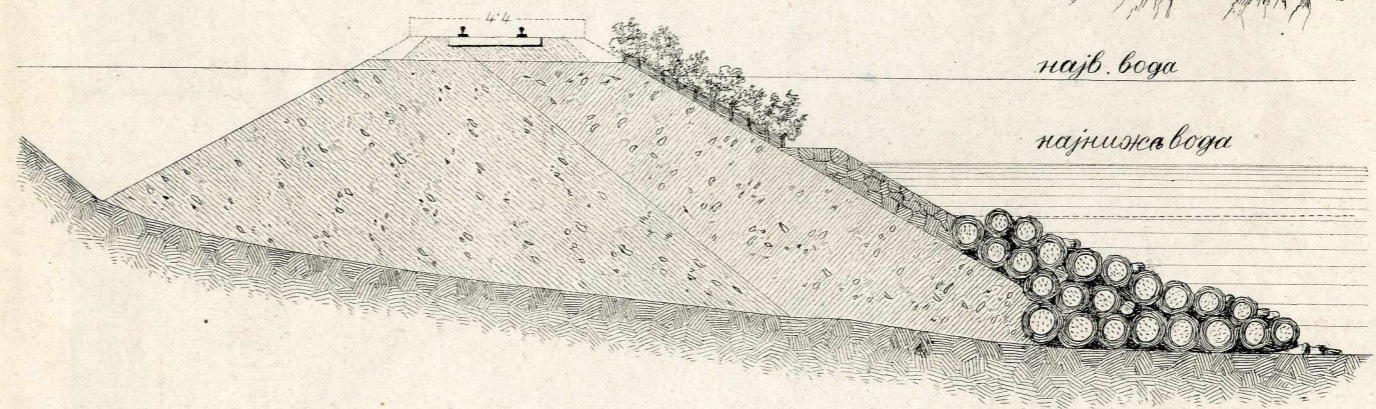

Сл. 25.

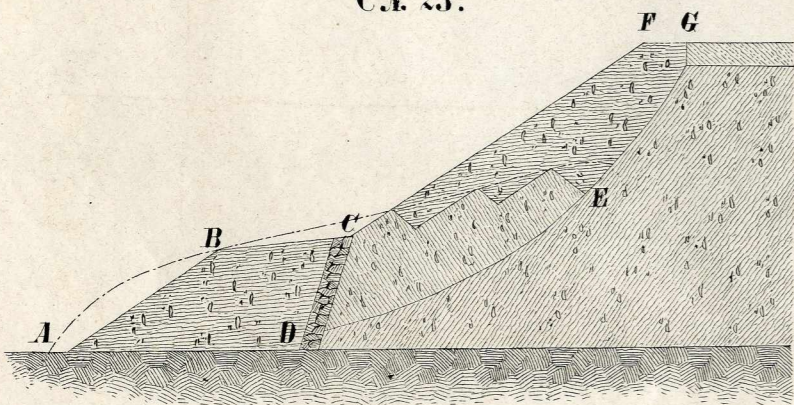

Сл. 26.

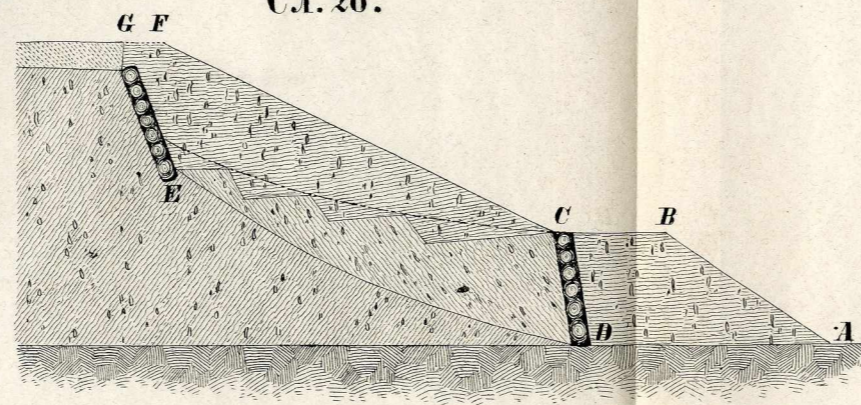

Сл. 27.

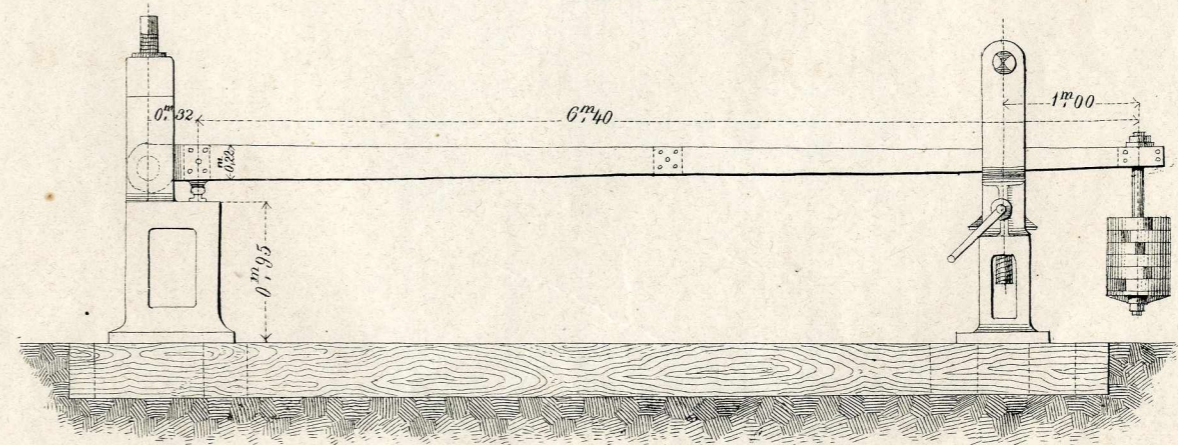

Сл. 29.

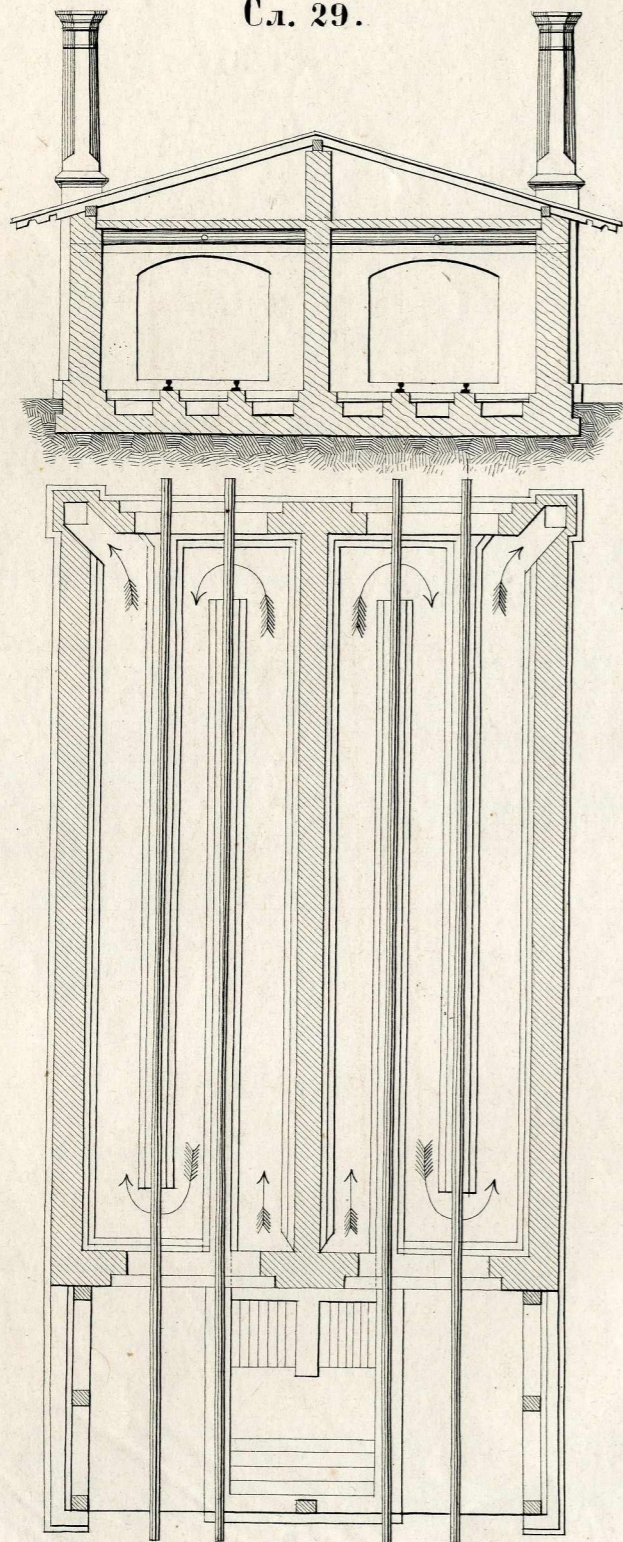

Сл. 30.

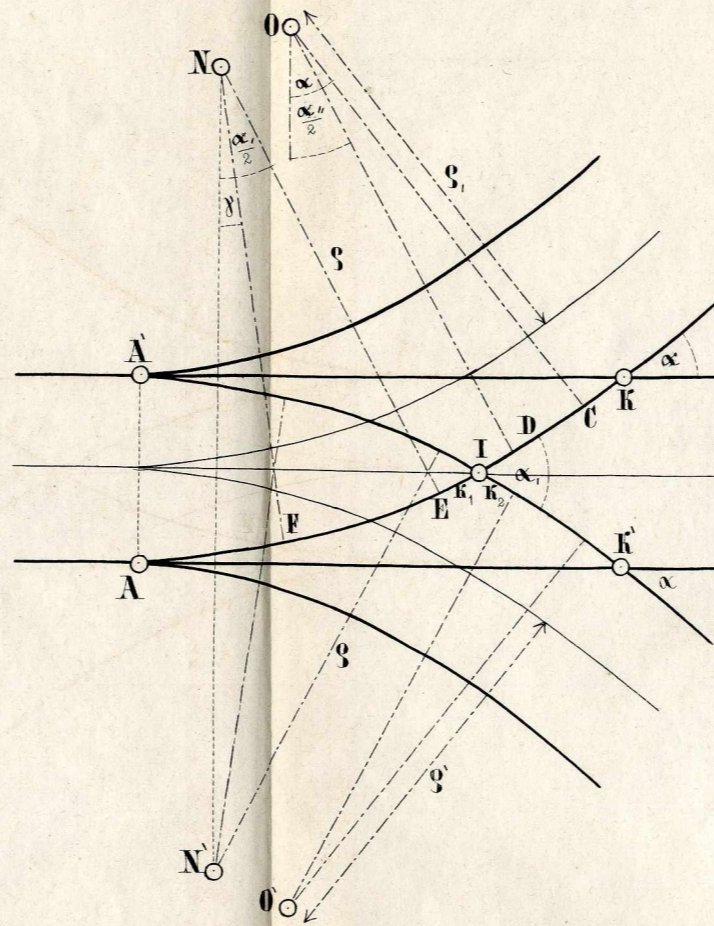

Сл. 31.

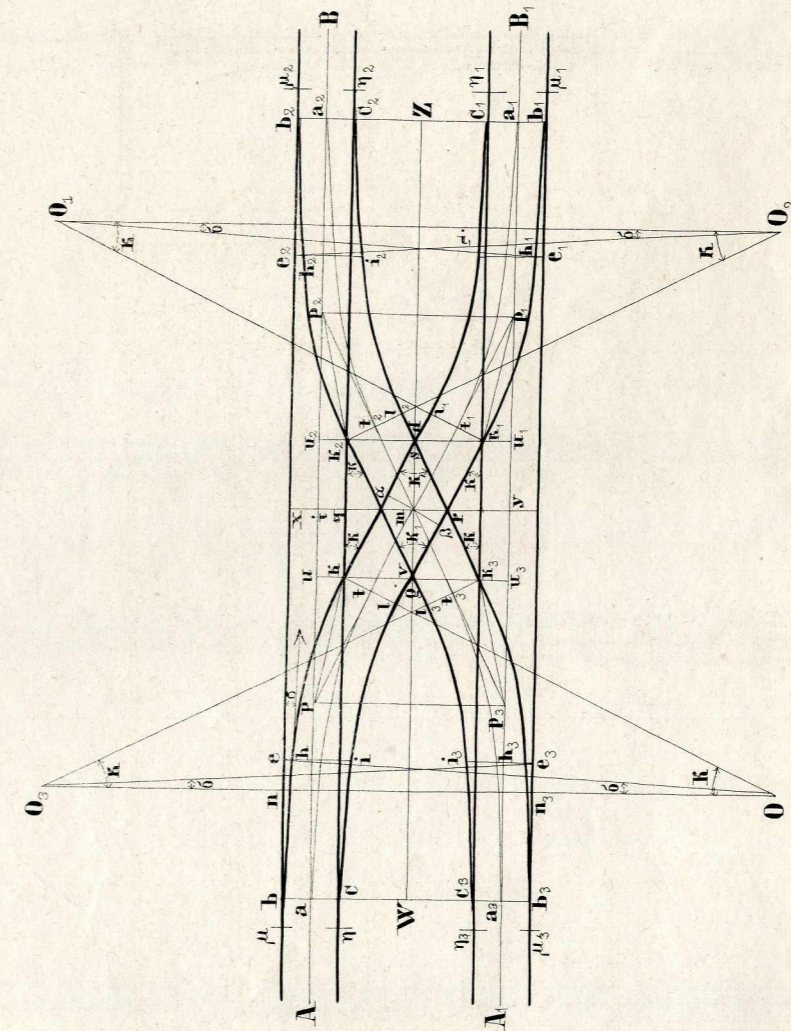

Сл. 32.

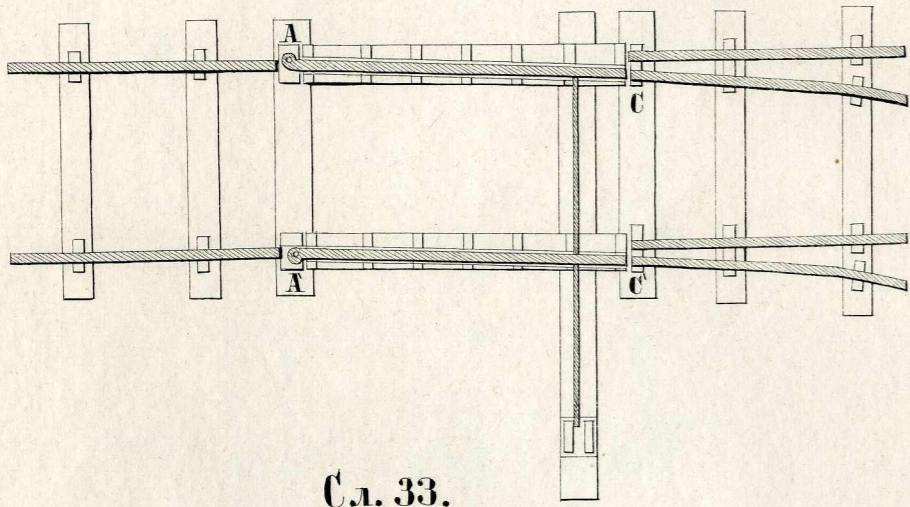

Сл. 33.

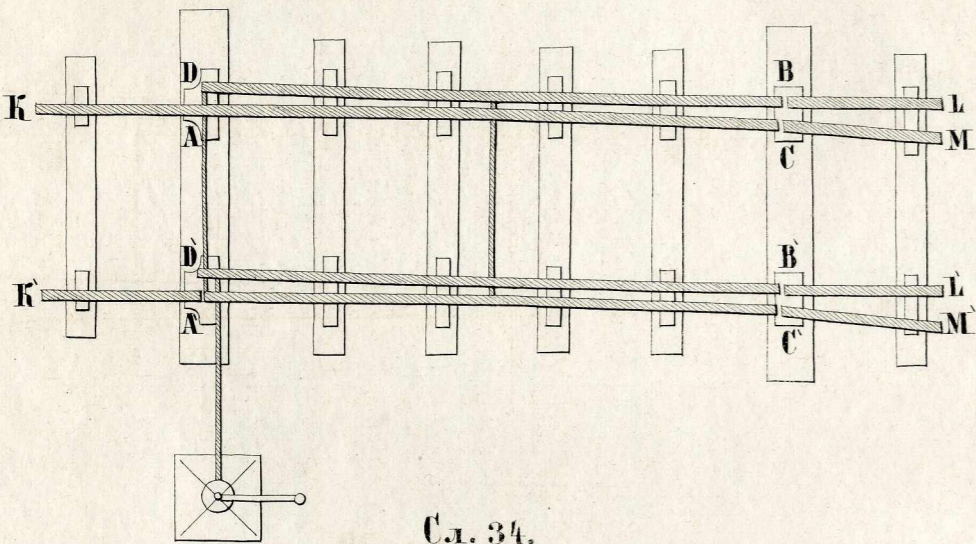

Сл. 34.

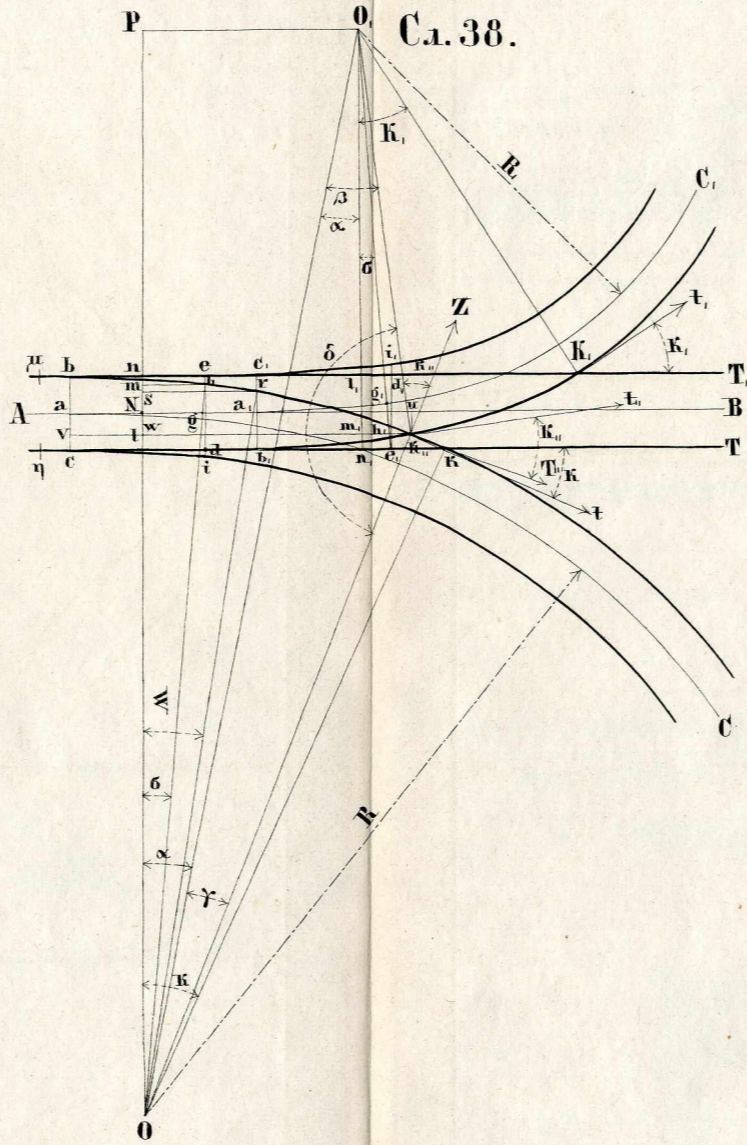
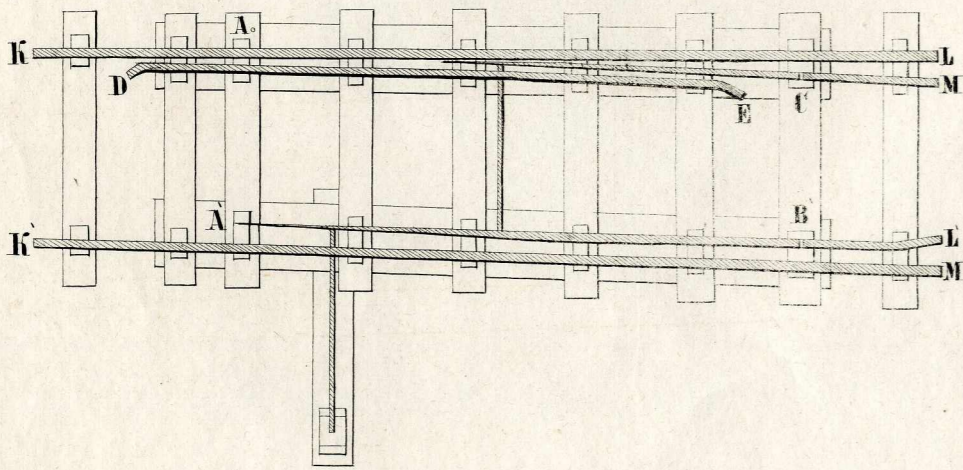

Сл. 35.

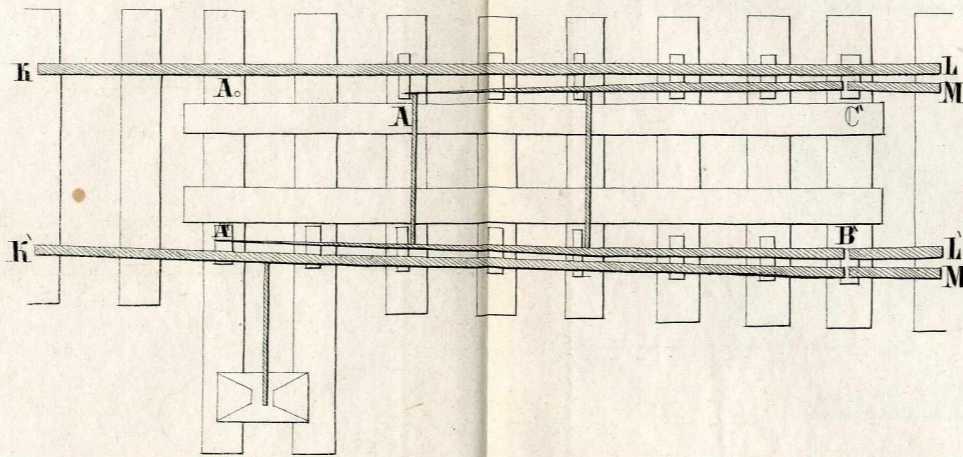

Сл. 36.

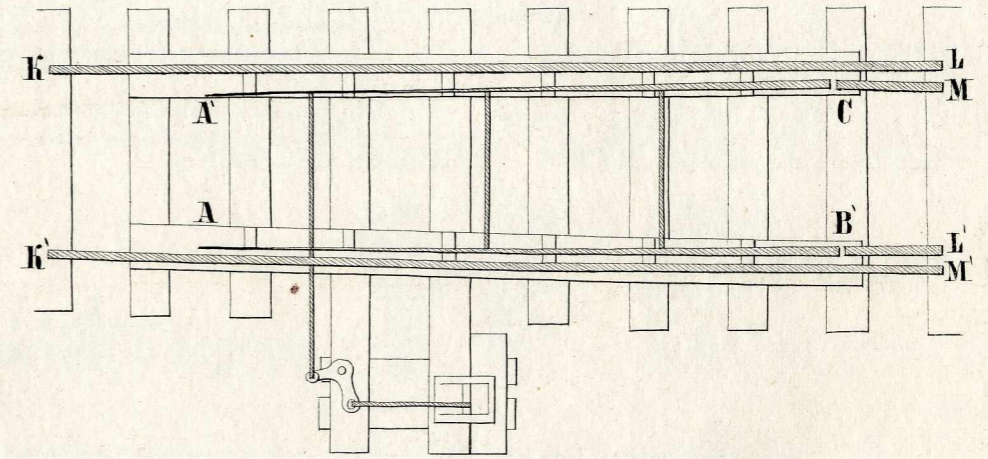

Сл. 37.

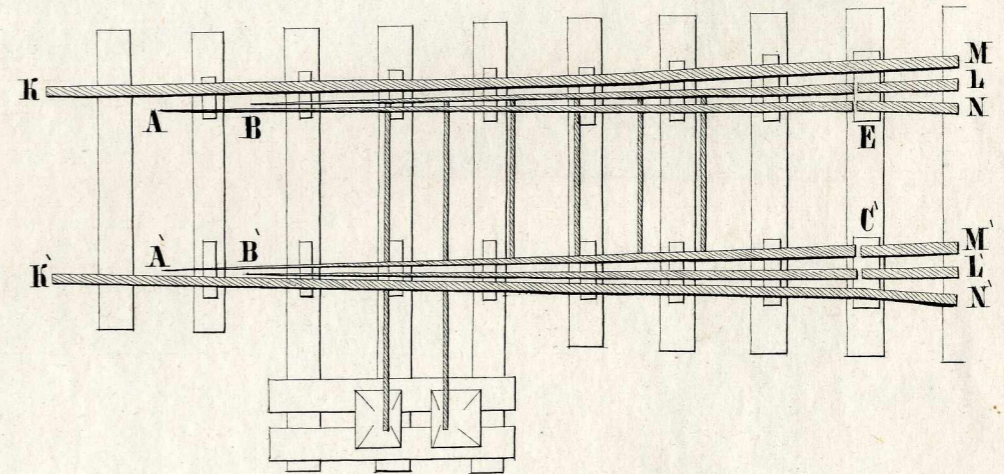

Сл. 38.

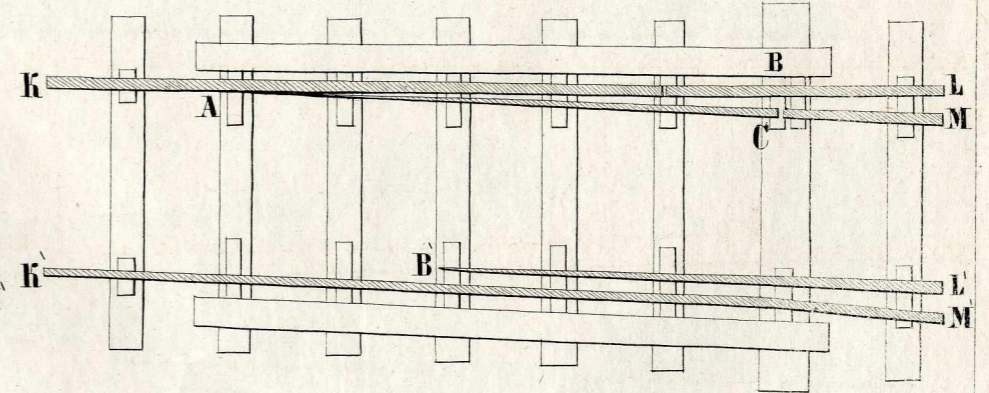

Сл. 40.

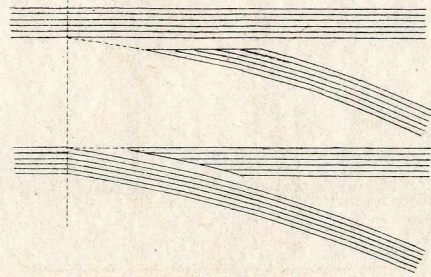

Сл. 41.

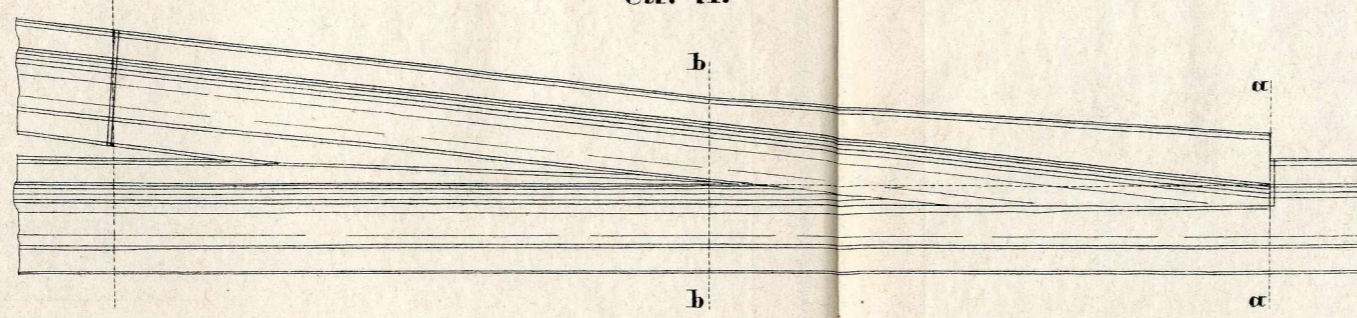

Сл. 42.

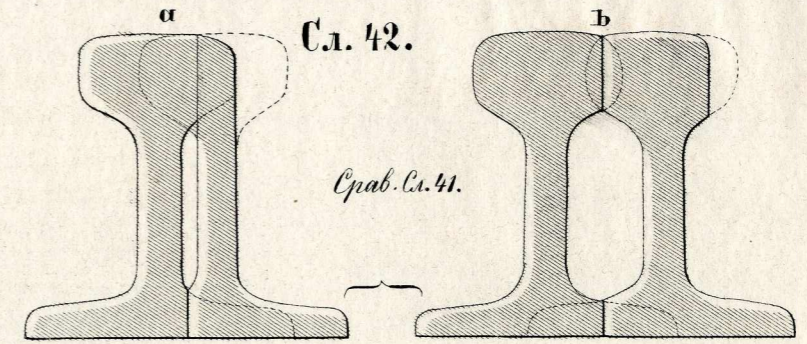

Срав. Сл. 41.

Сл. 45.

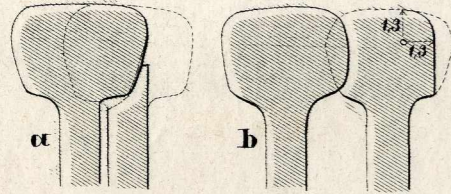

Сл. 43.

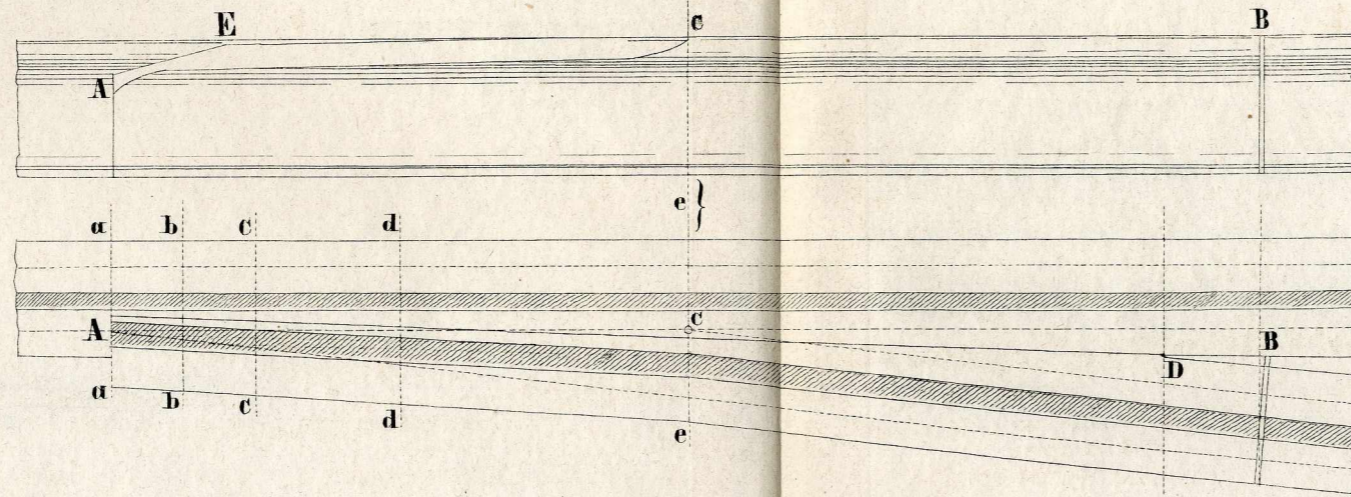

Сл. 47.

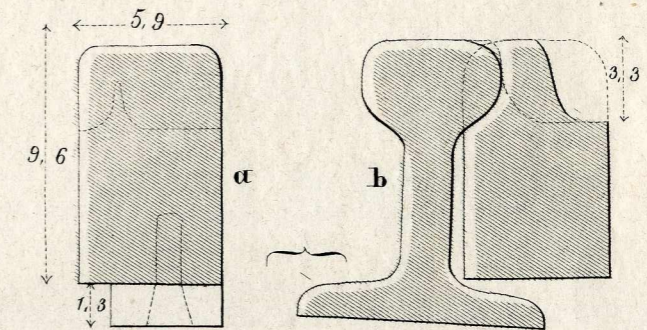

Сл. 50.

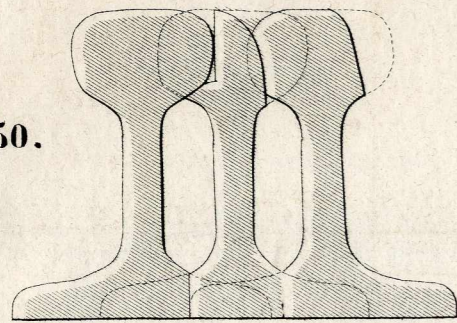

Сл. 44.

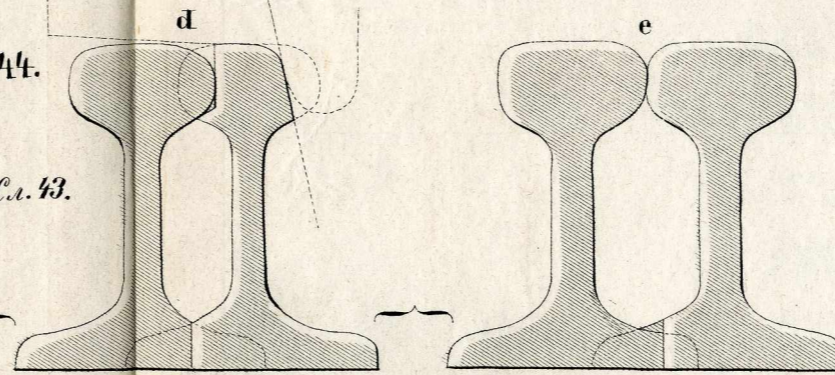

Срав. Сл. 43.

Сл. 46.

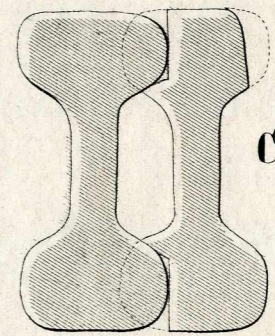

Сл. 48.

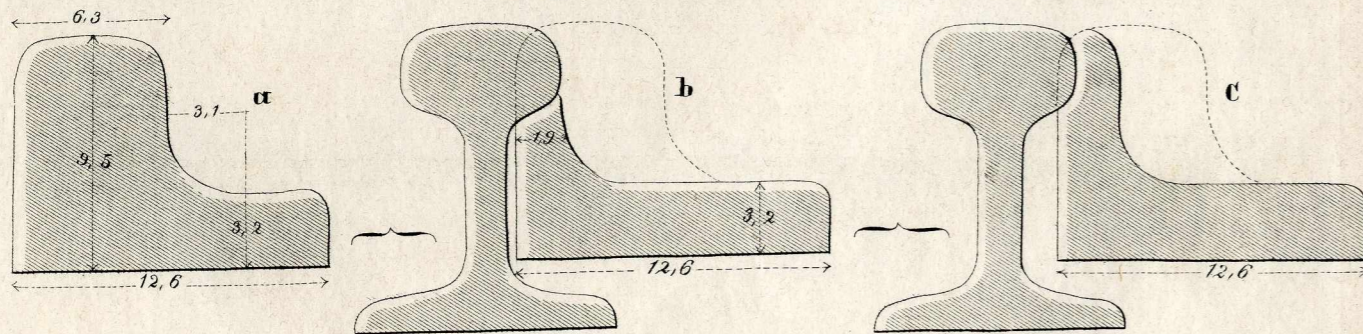

Сл. 49.

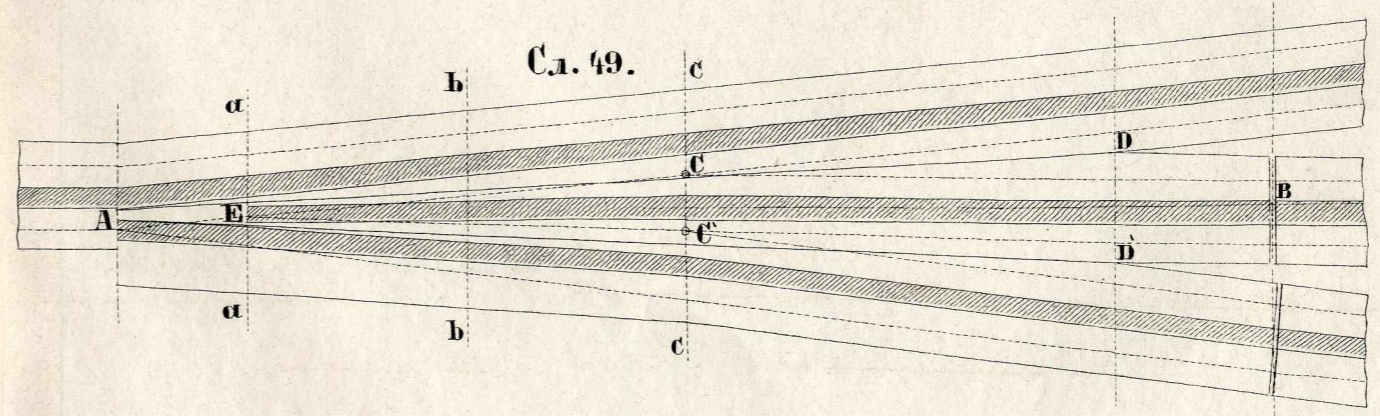

Сл. 51.

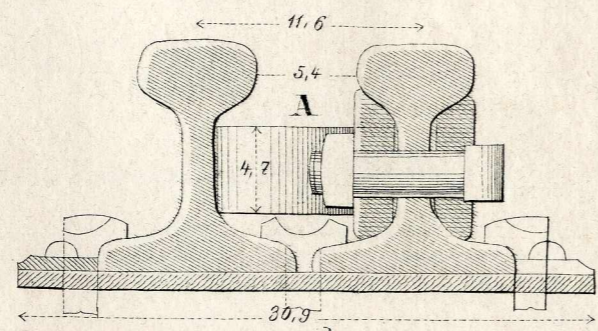
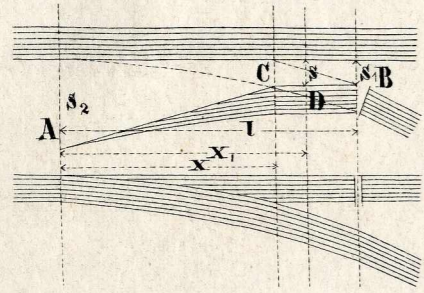

Сл. 56.

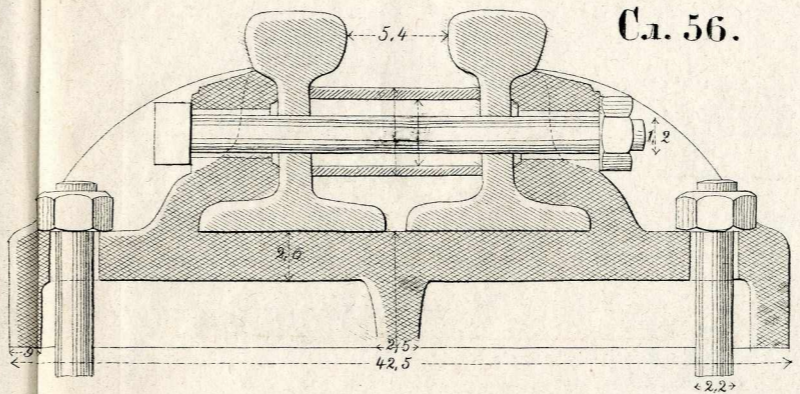

Сл. 52.

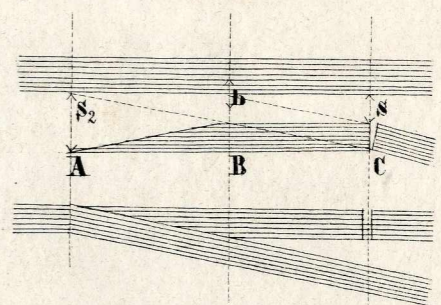

Сл. 54.

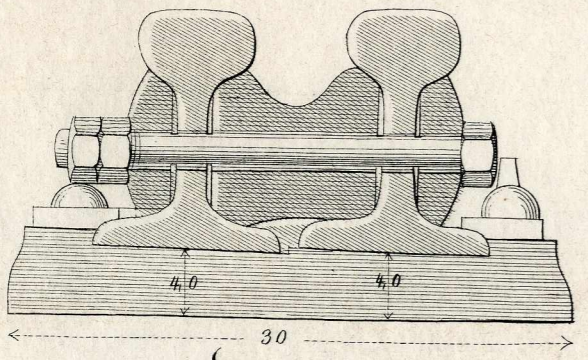

Сл. 53.

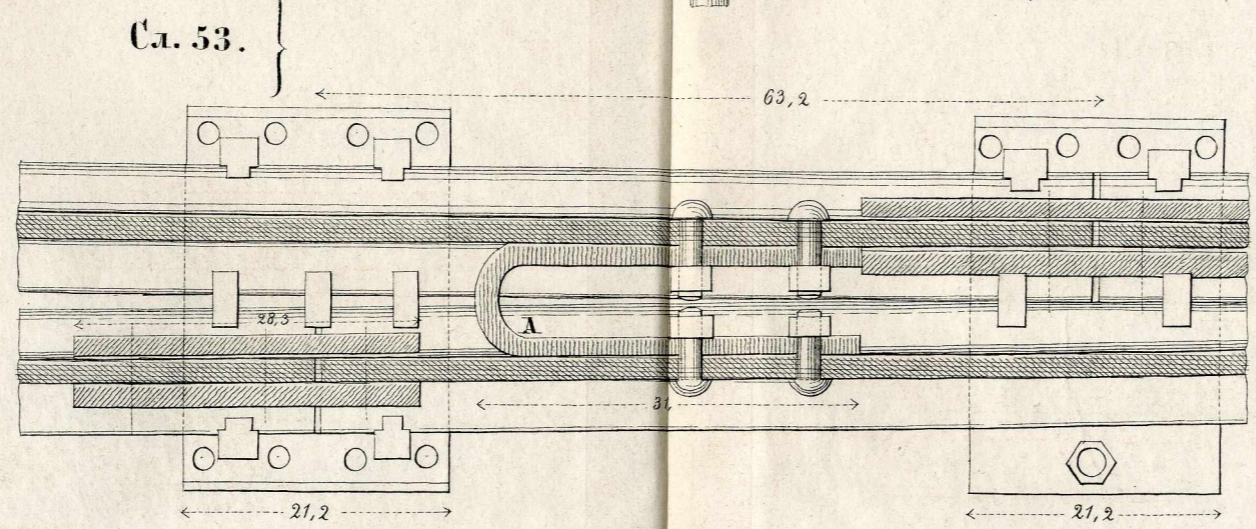

Сл. 55.

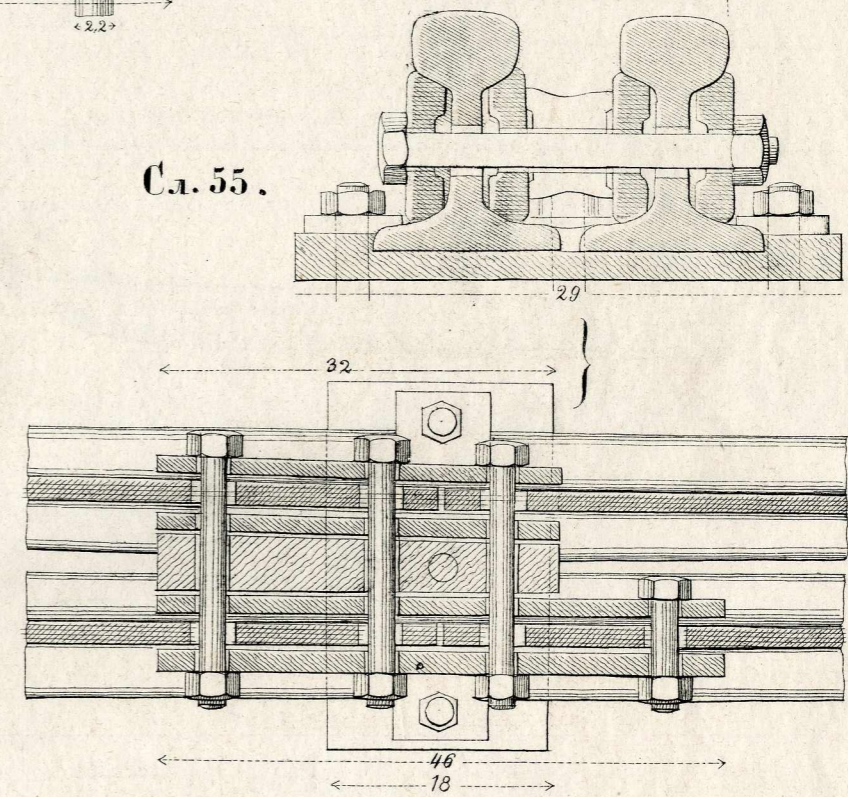

Сл. 58.

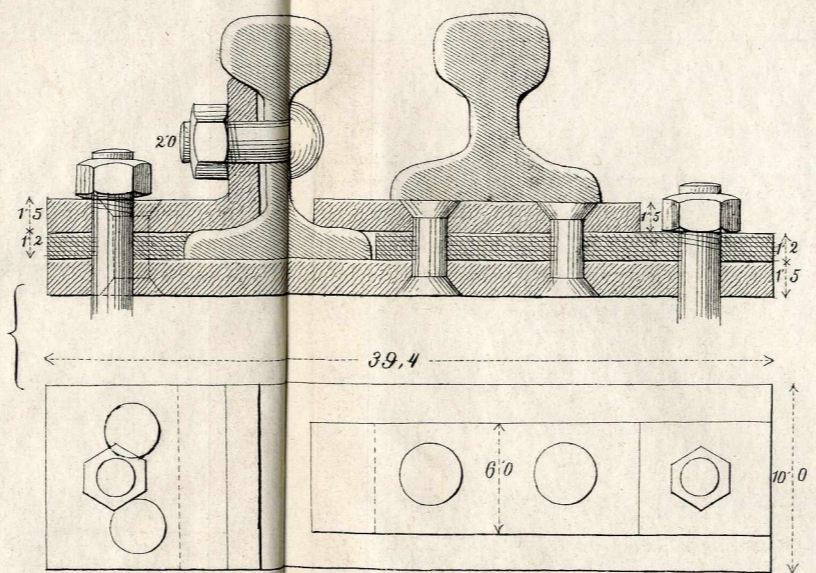

Сл. 59.

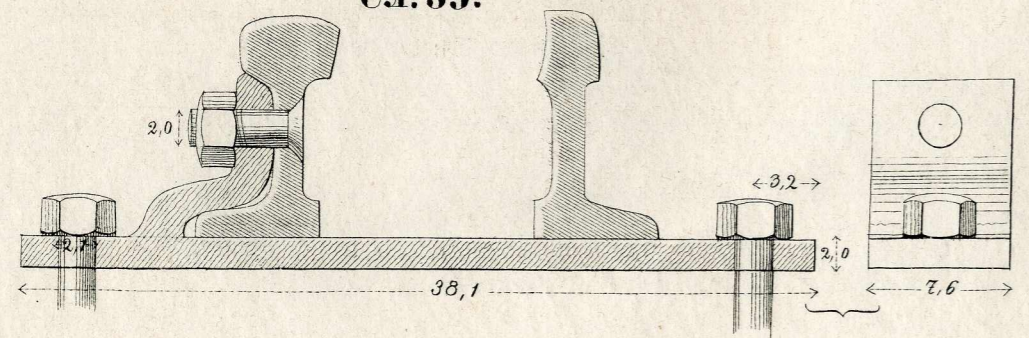

Сл. 57.

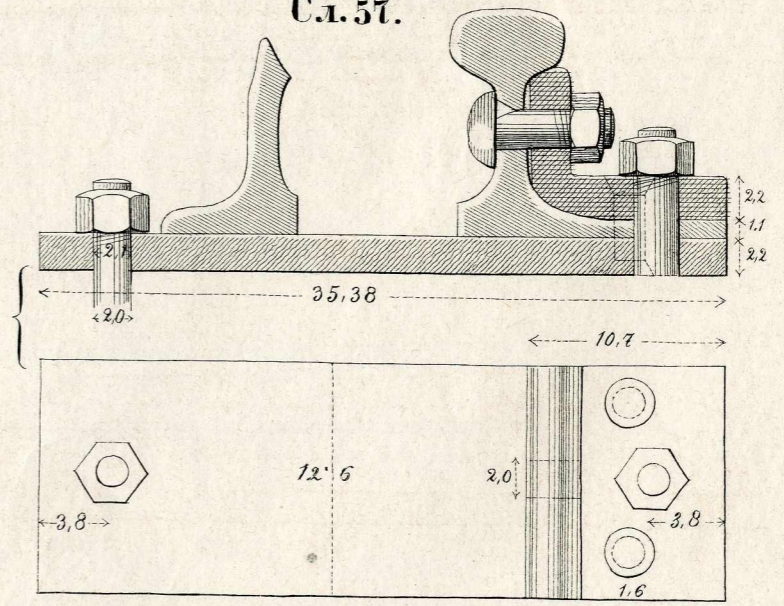

Сл. 60.

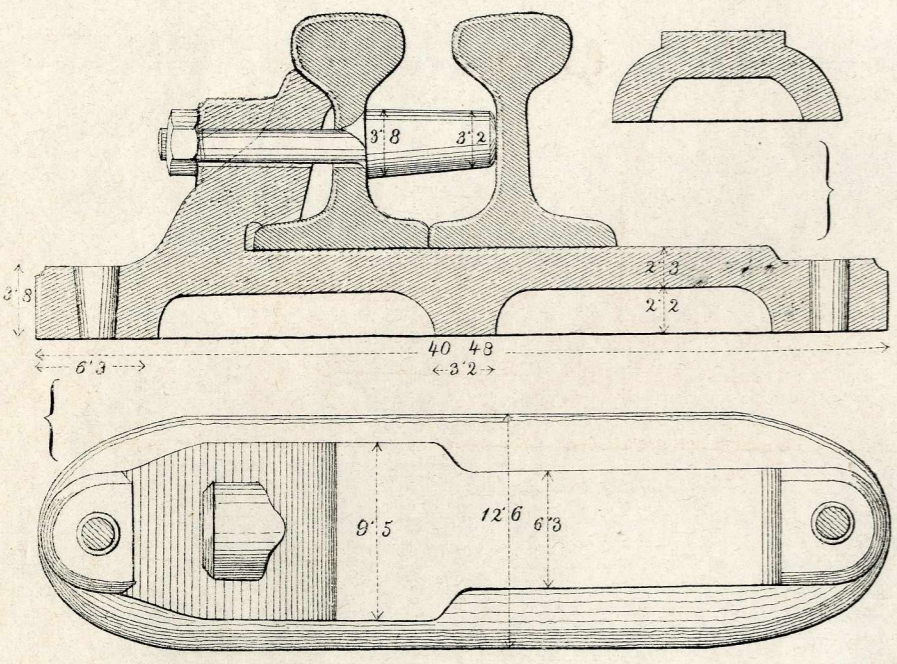

Сл. 62.

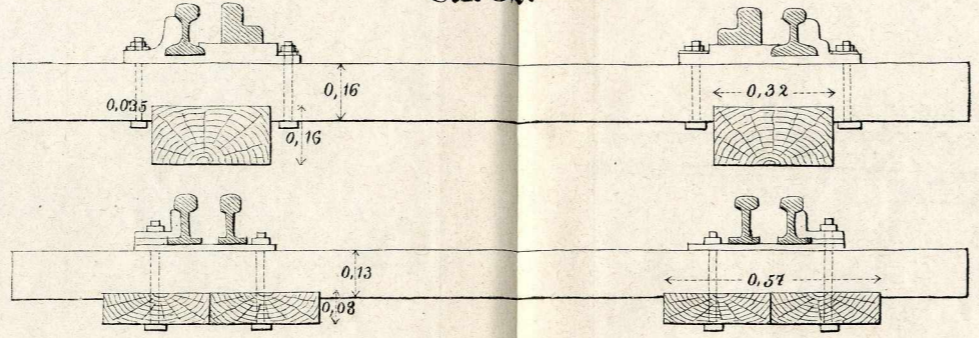

Сл. 63.

Сл. 61.

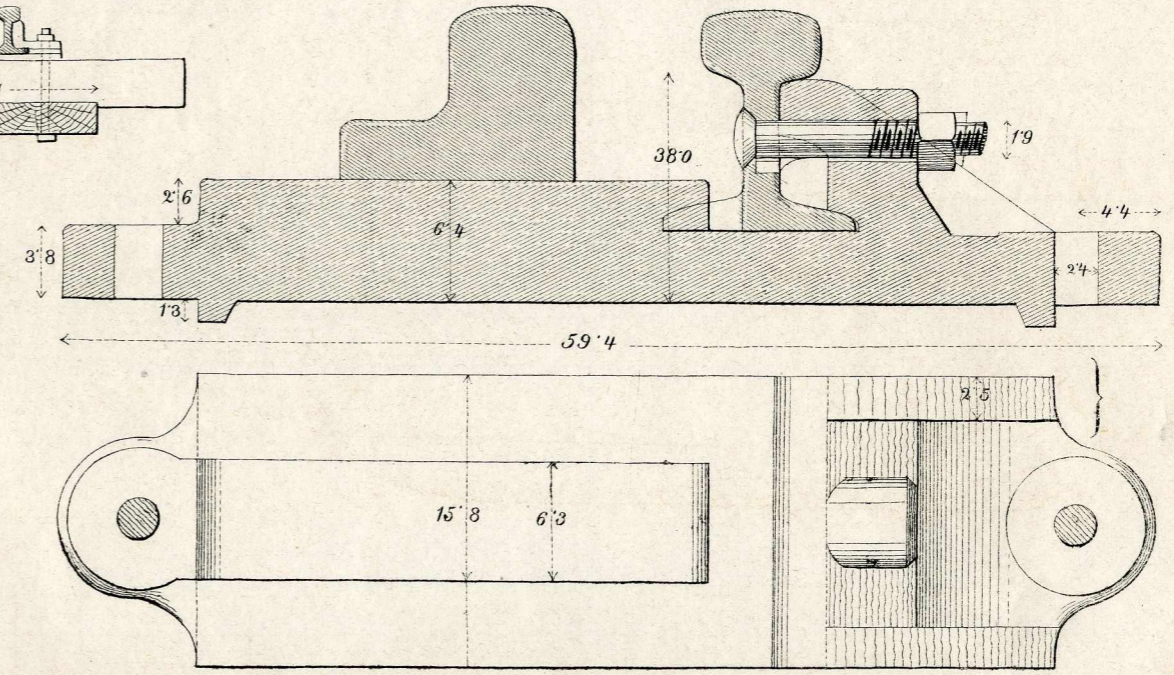

Сл. 64.

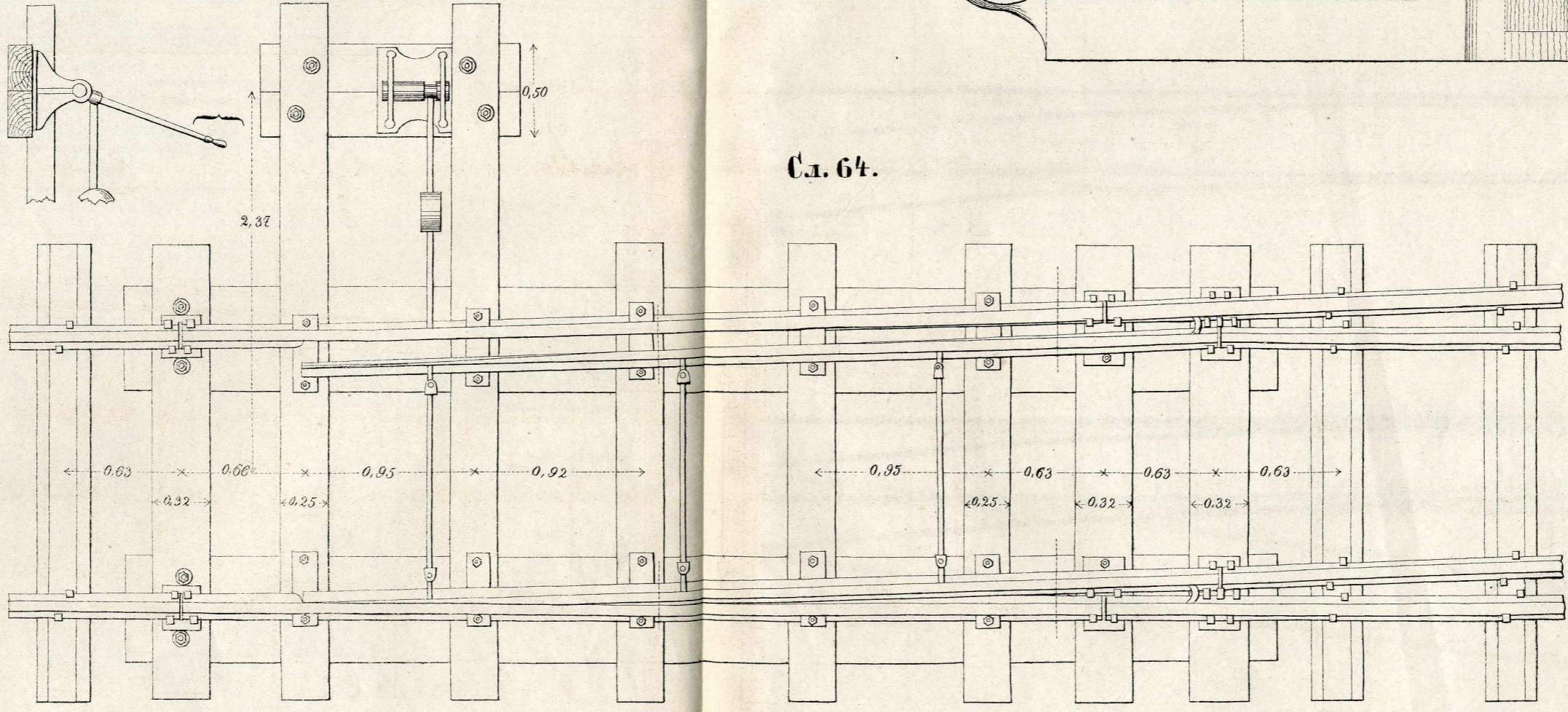

Сл. 68.

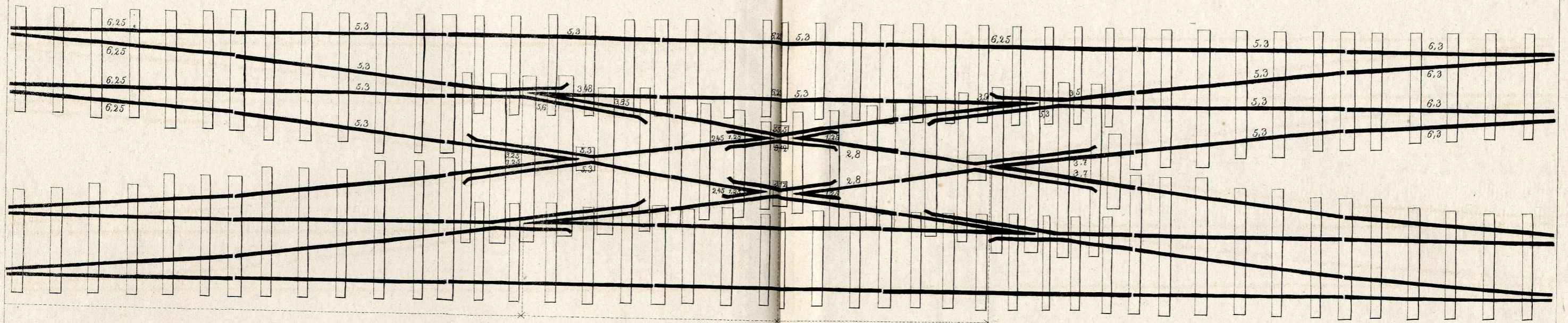

Сл. 69.

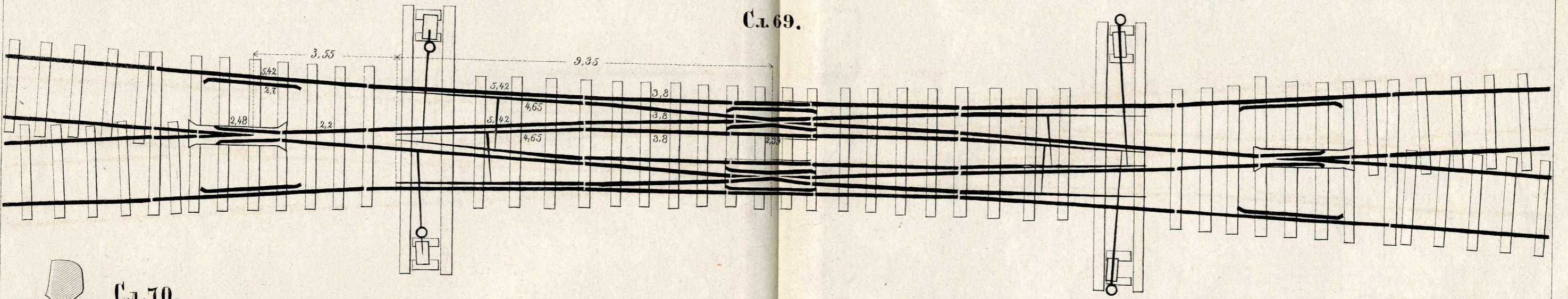

Сл. 70.

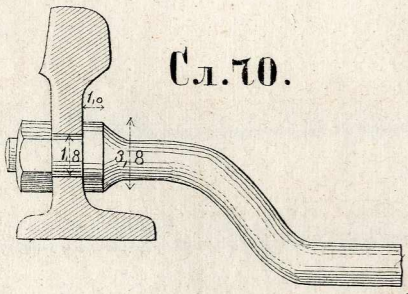

Сл. 72.

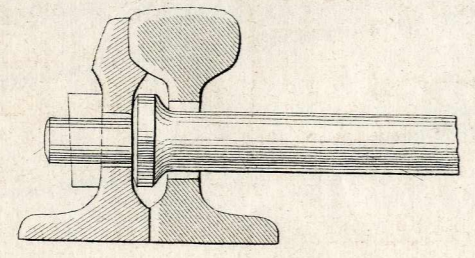

Сл. 73.

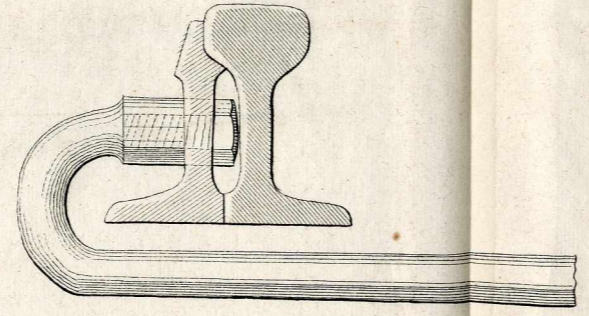

Сл. 74.

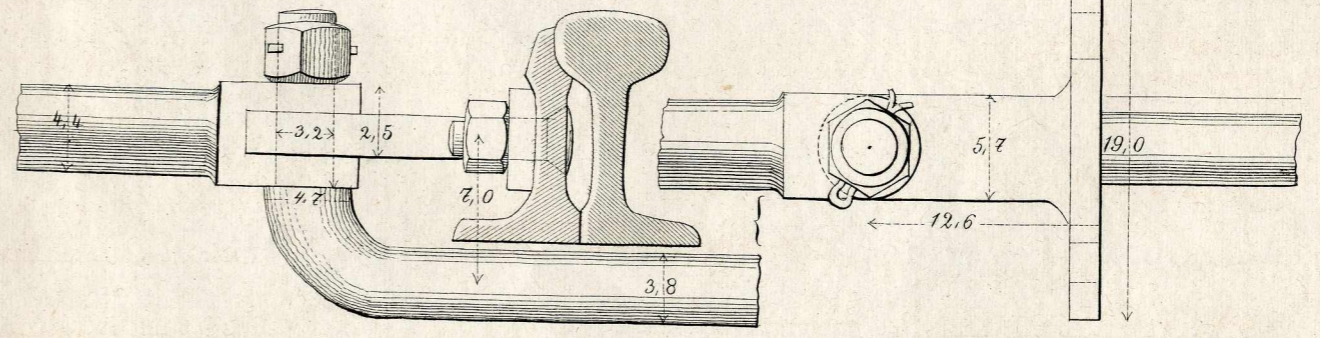

Сл. 71.

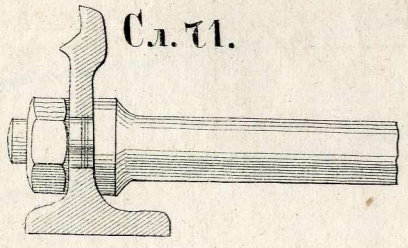

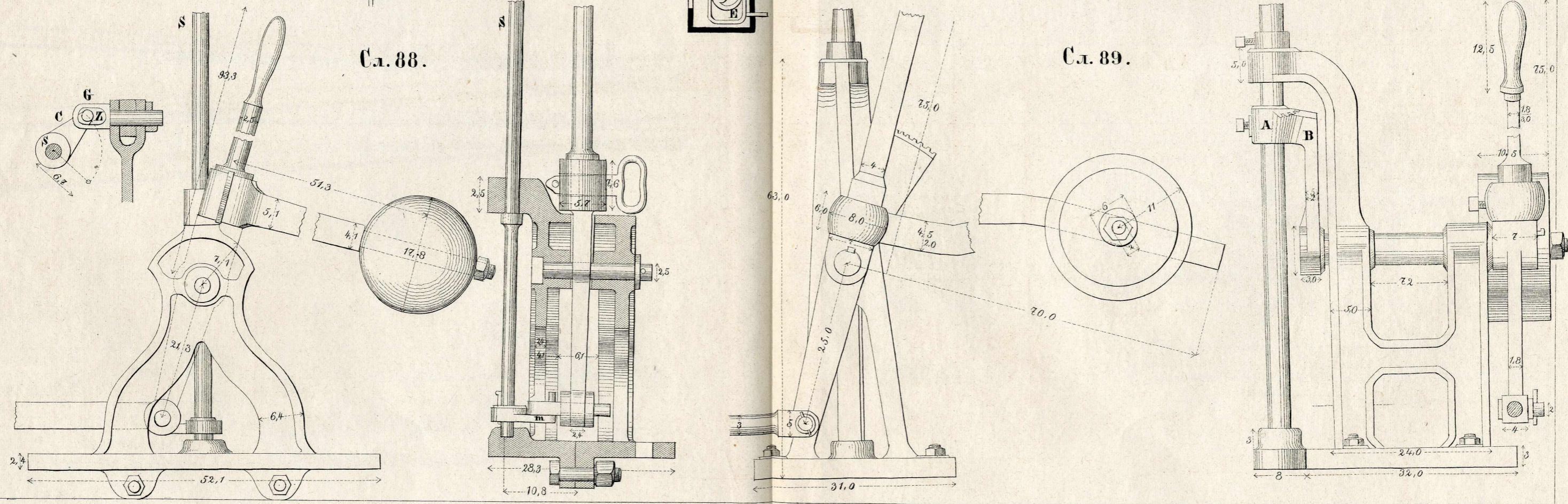
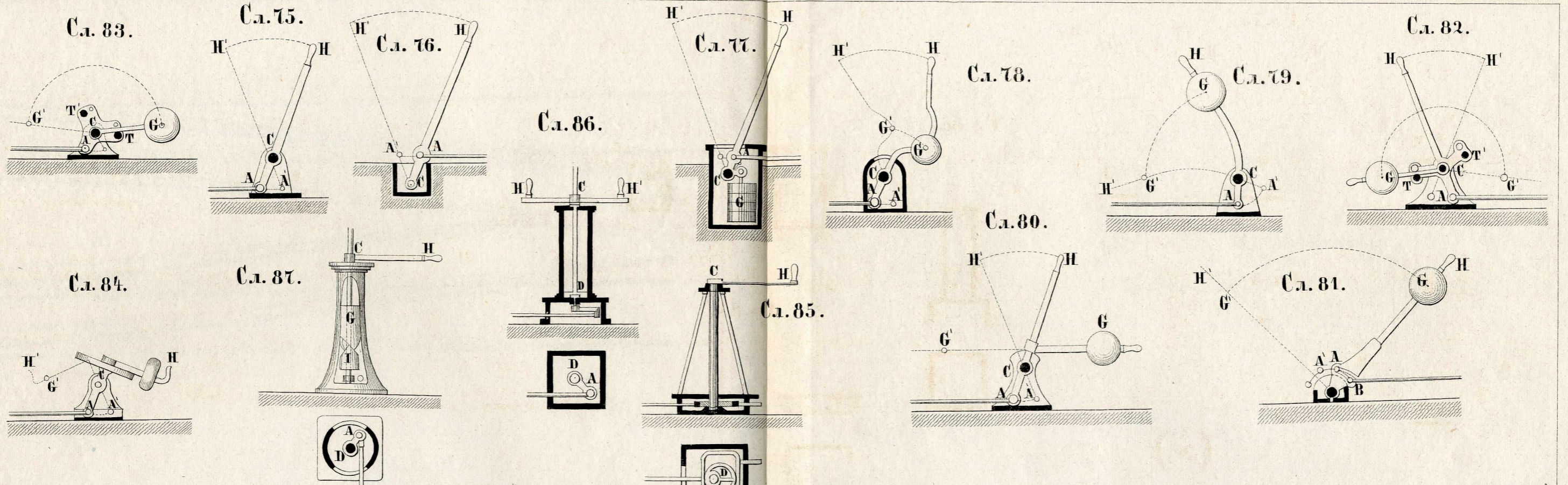

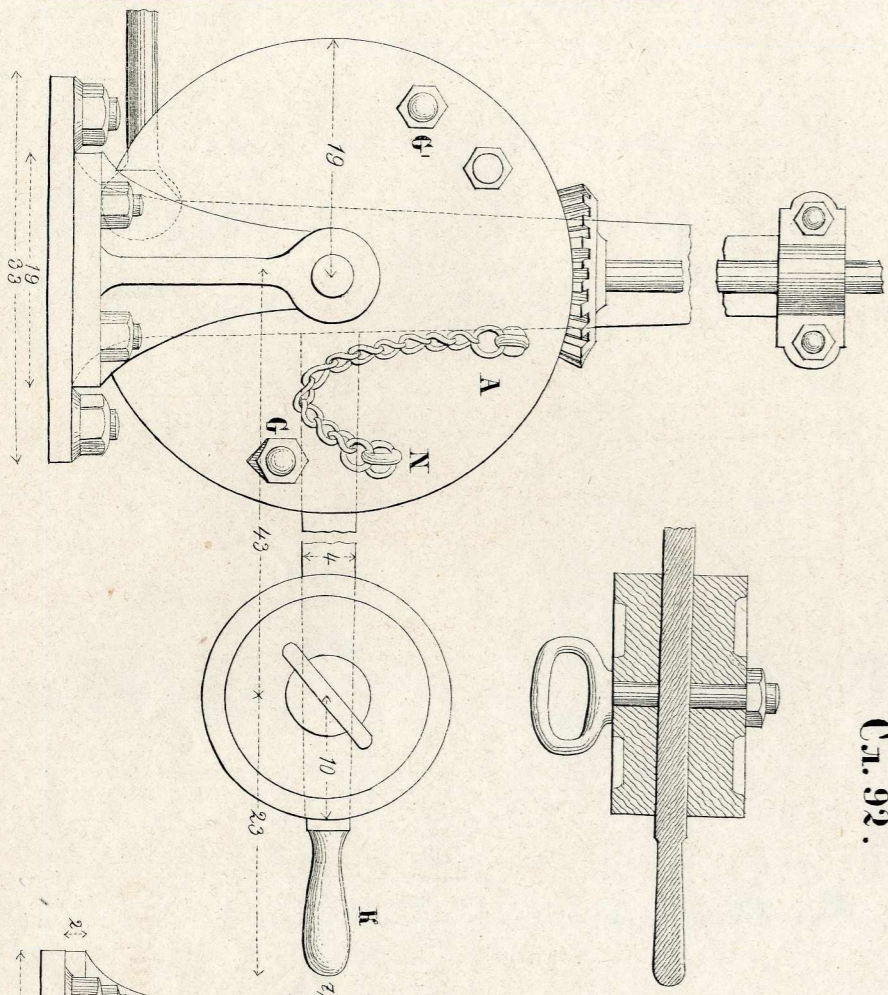

Сл. 92.

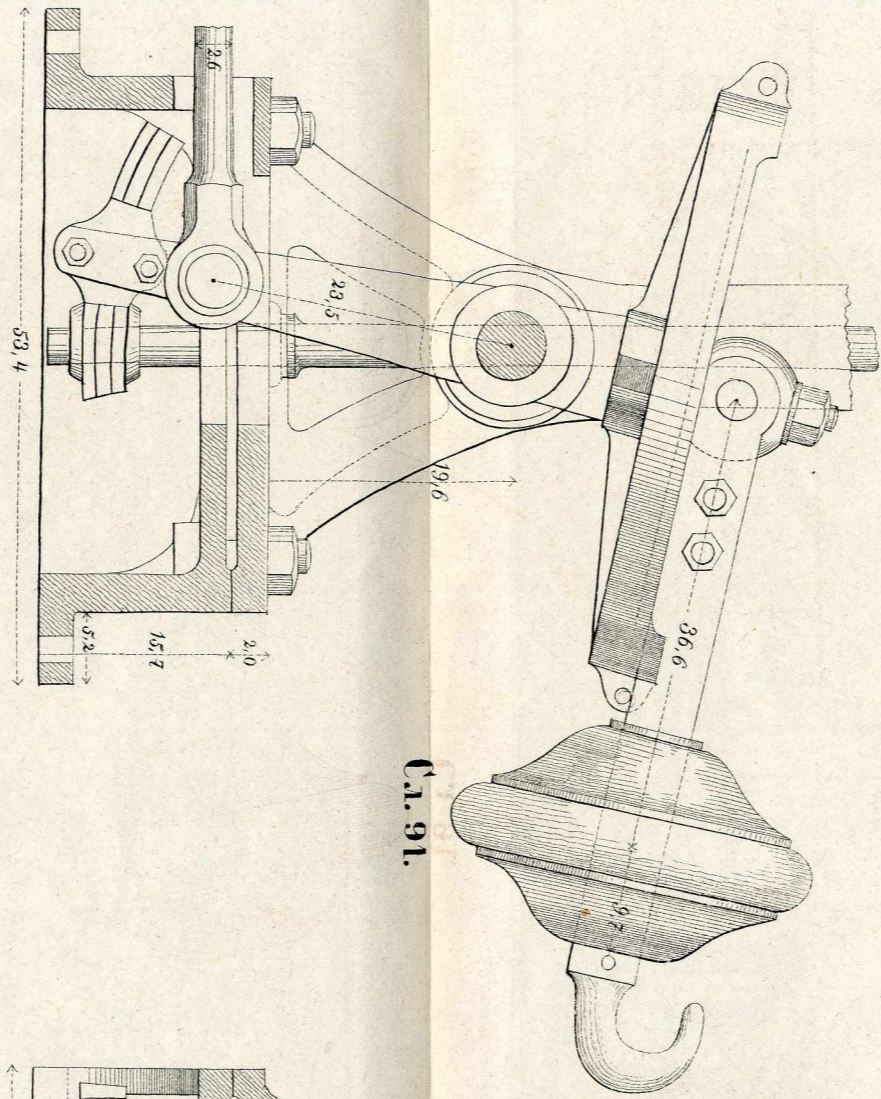
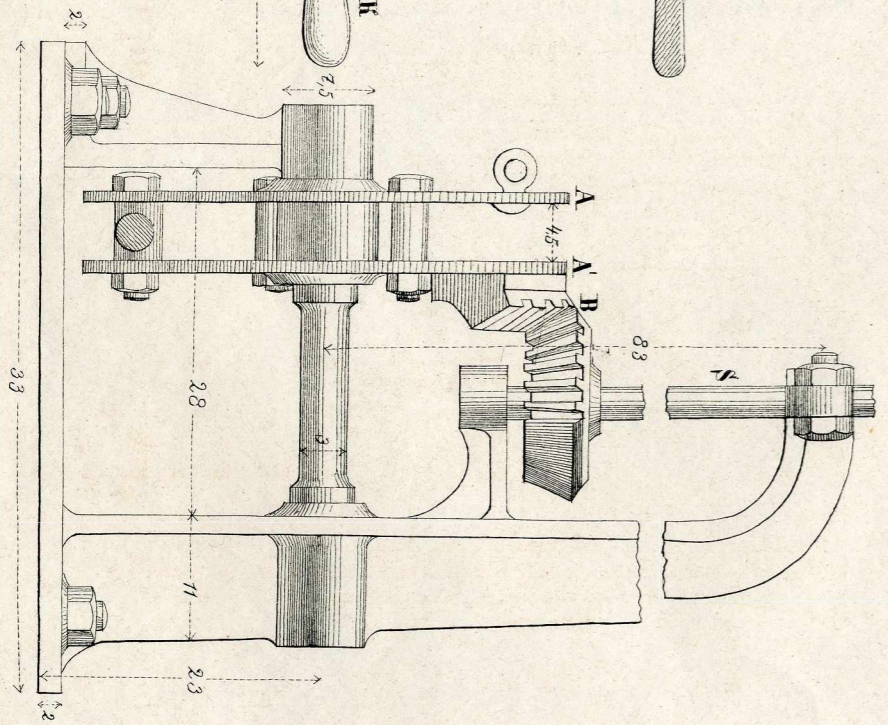

Сл. 91.

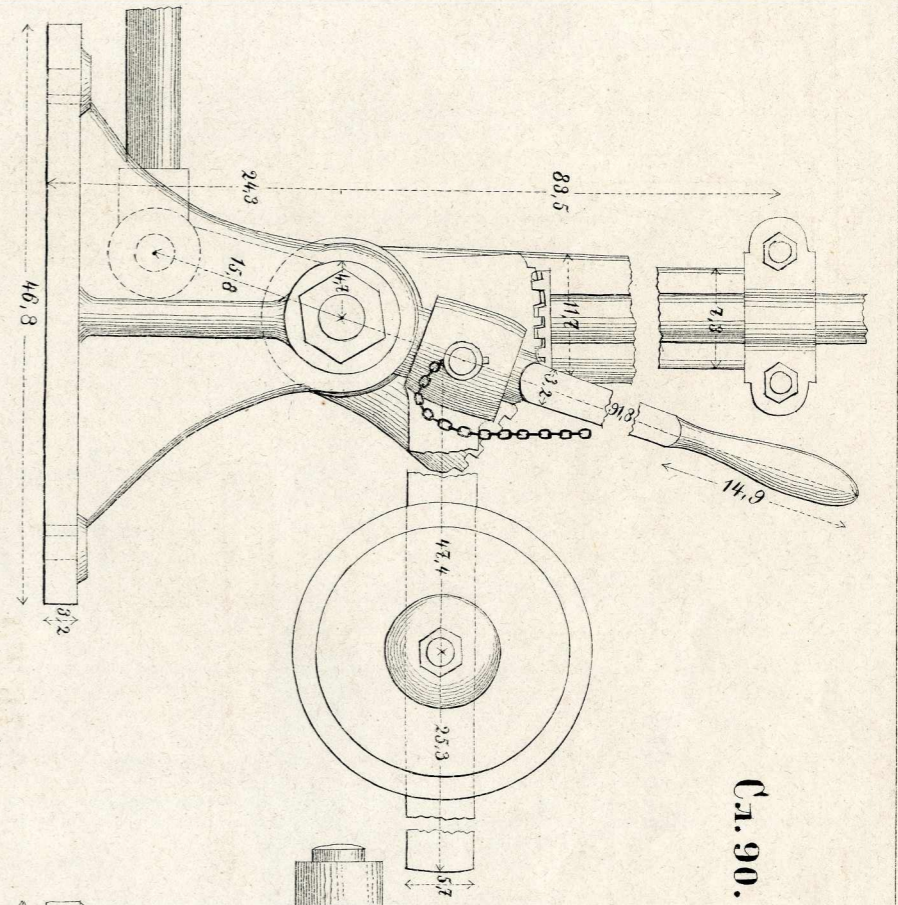
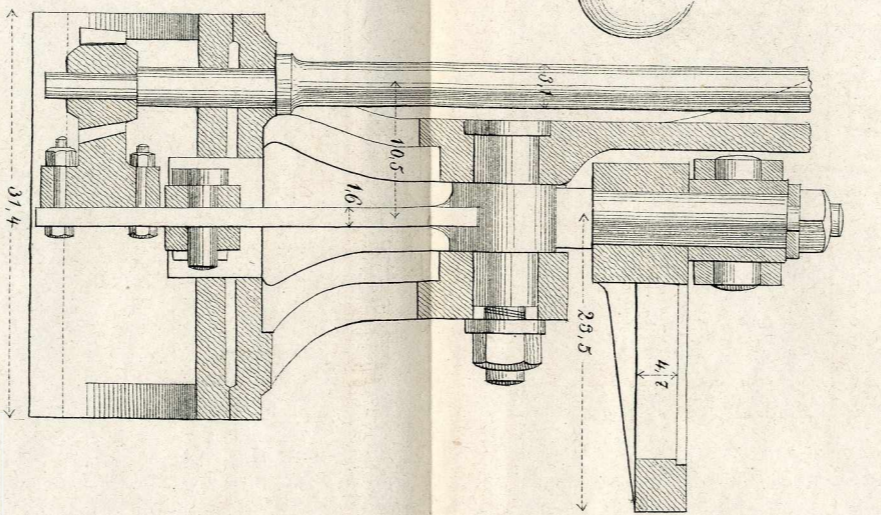

Сл. 90.

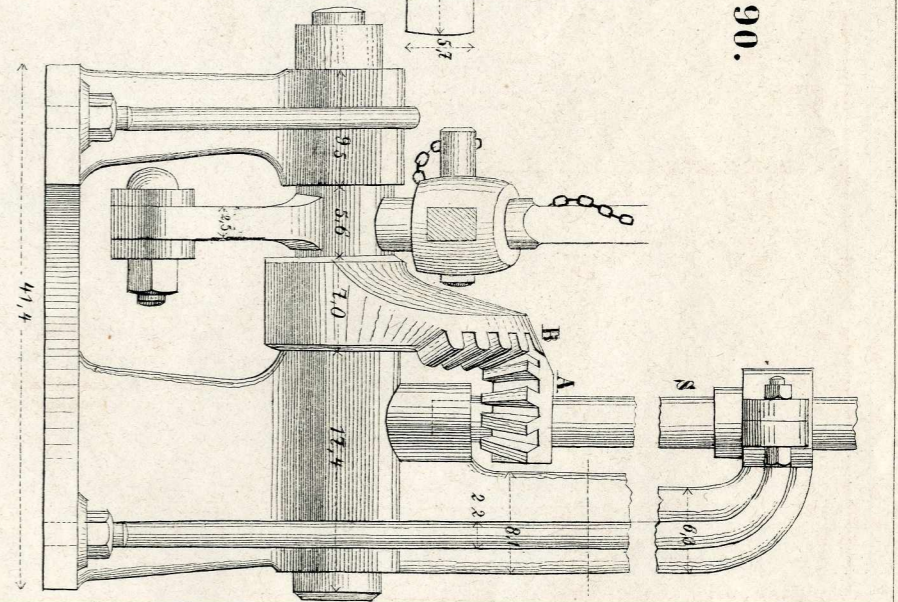

Сл. 93.

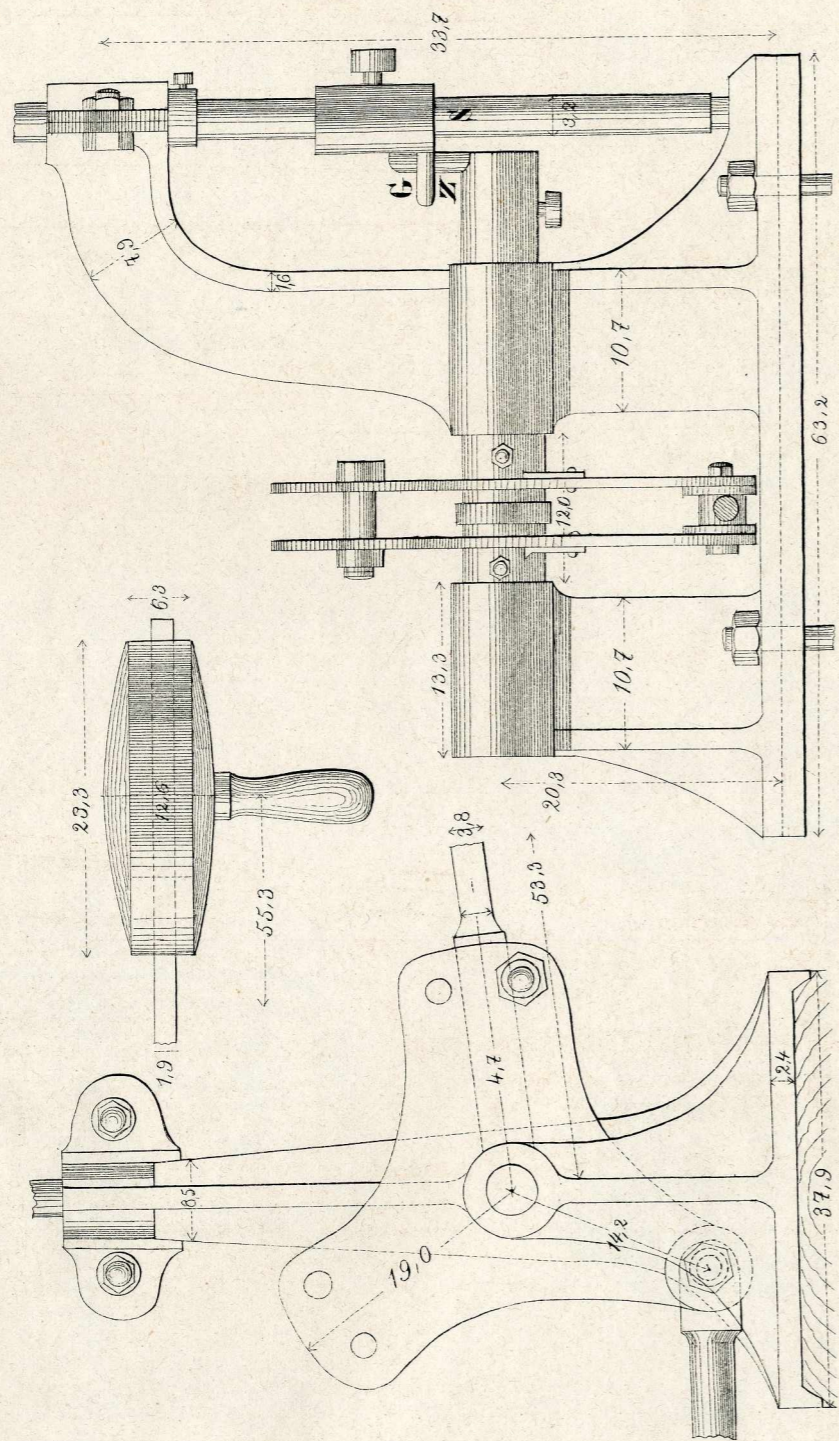

Сл. 94.

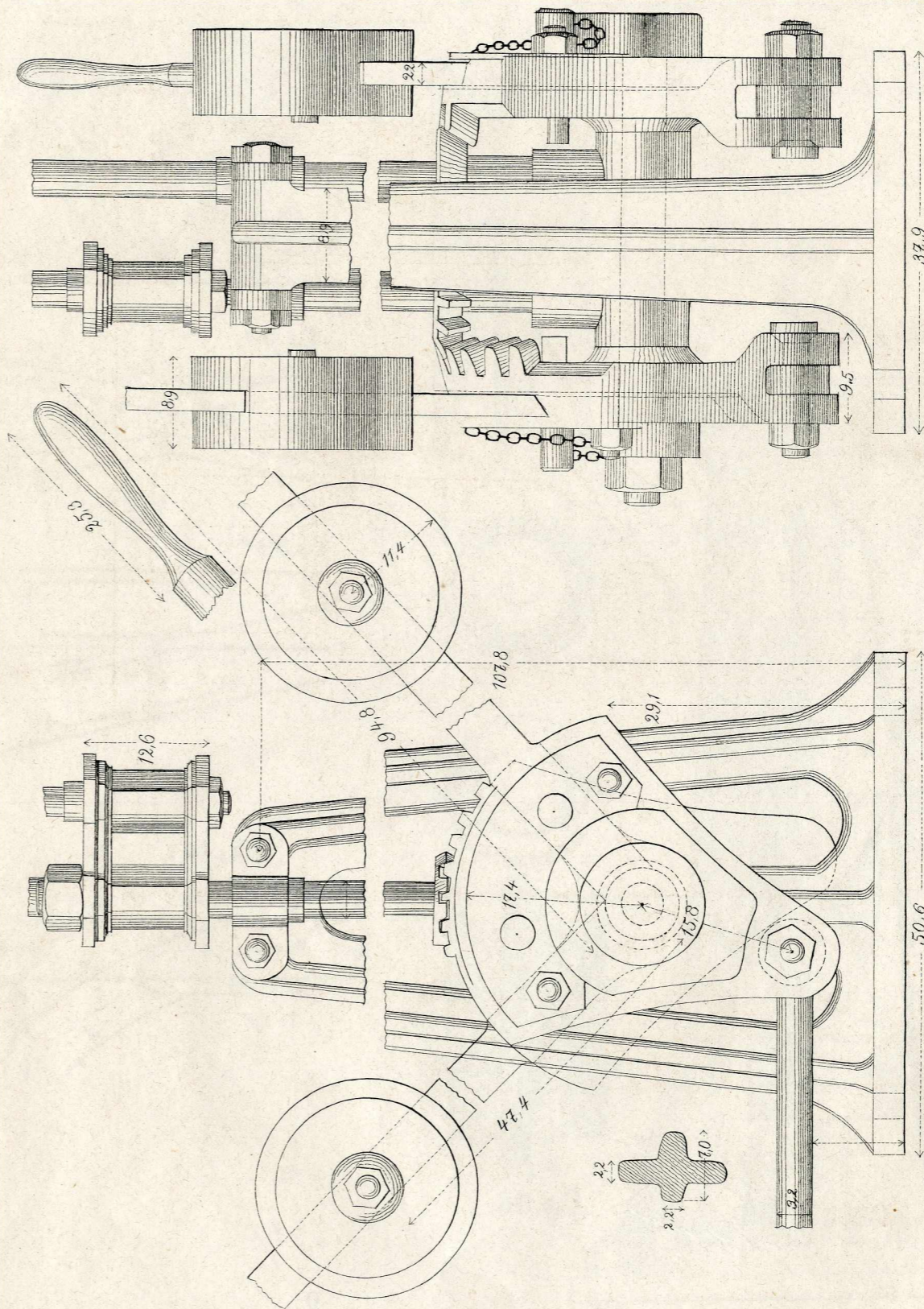

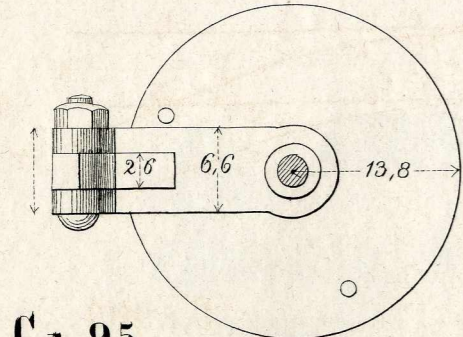

Сл. 95.

Сл. 97.

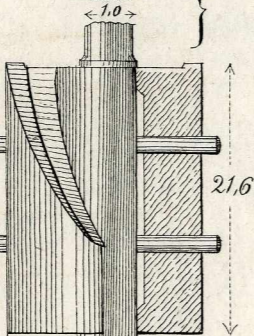
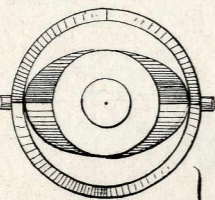
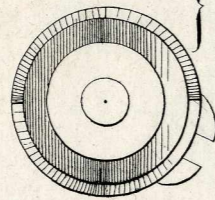
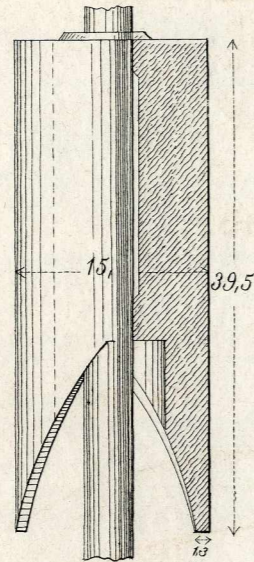

Сл. 96.

Сл. 98.

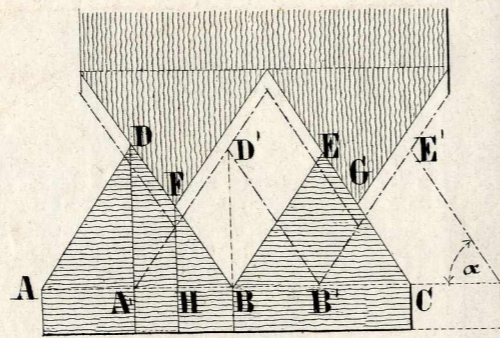

Сл. 99.

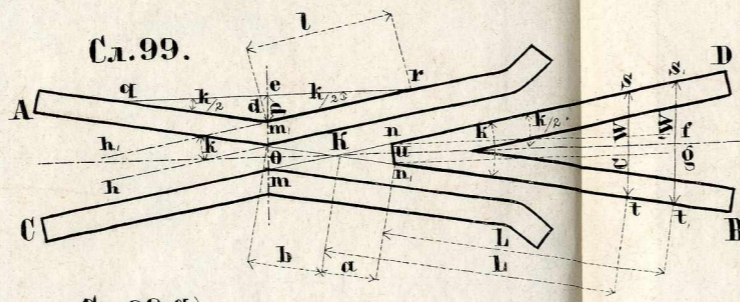

Сл. 99-а)

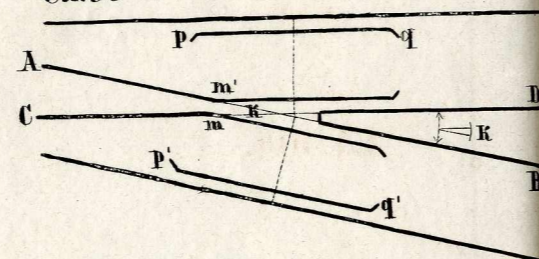

Сл. 101.

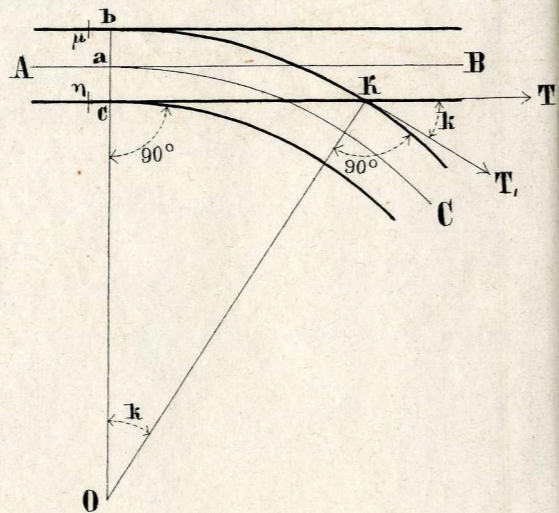

У ДРЖАВНОЈ КАМЕНОБЕЗНИЦИ У БЕОГРАДУ.

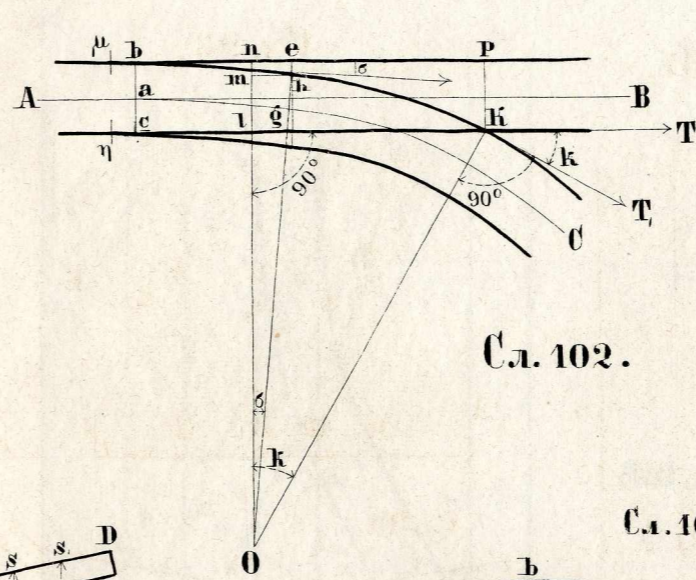

Сл. 102.

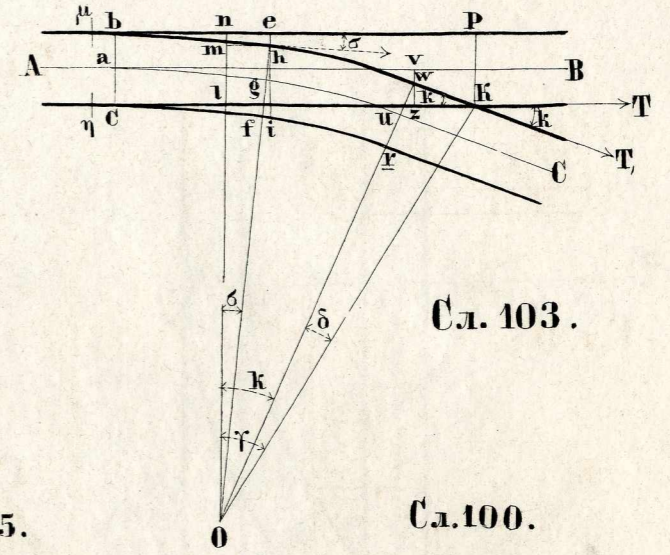

Сл. 103.

Сл. 105.

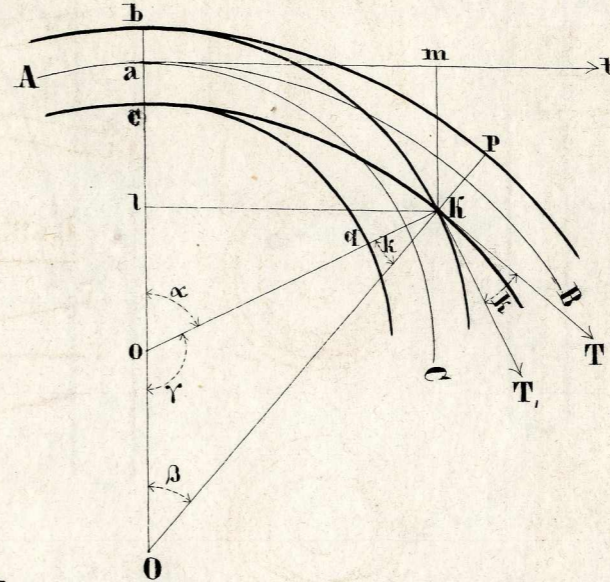

Сл. 100.

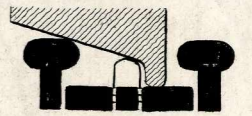

Сл. 104.

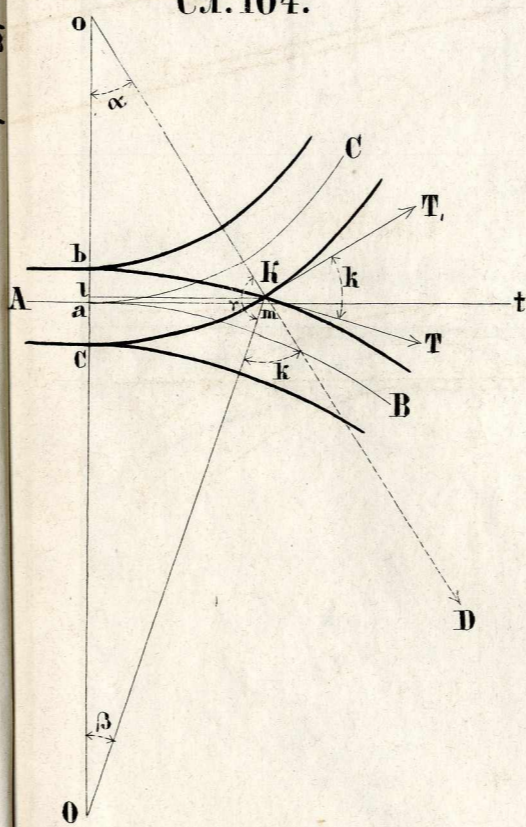

Сл. 106.

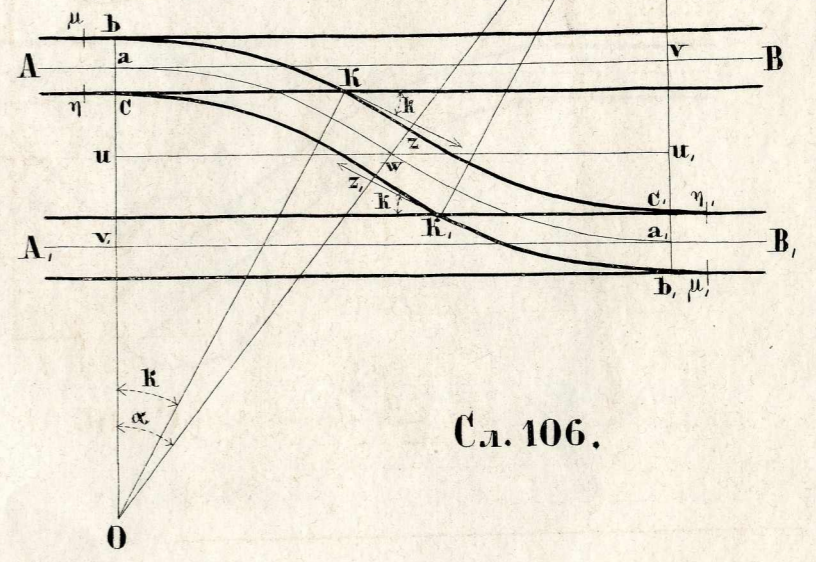

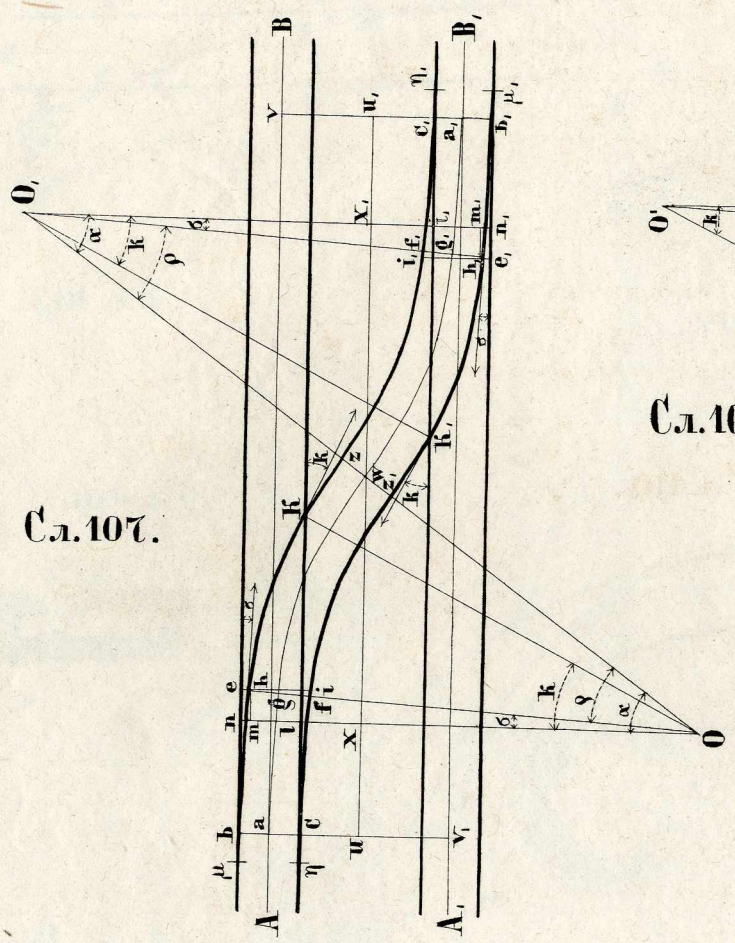

Сл. 107.

Сл. 108.

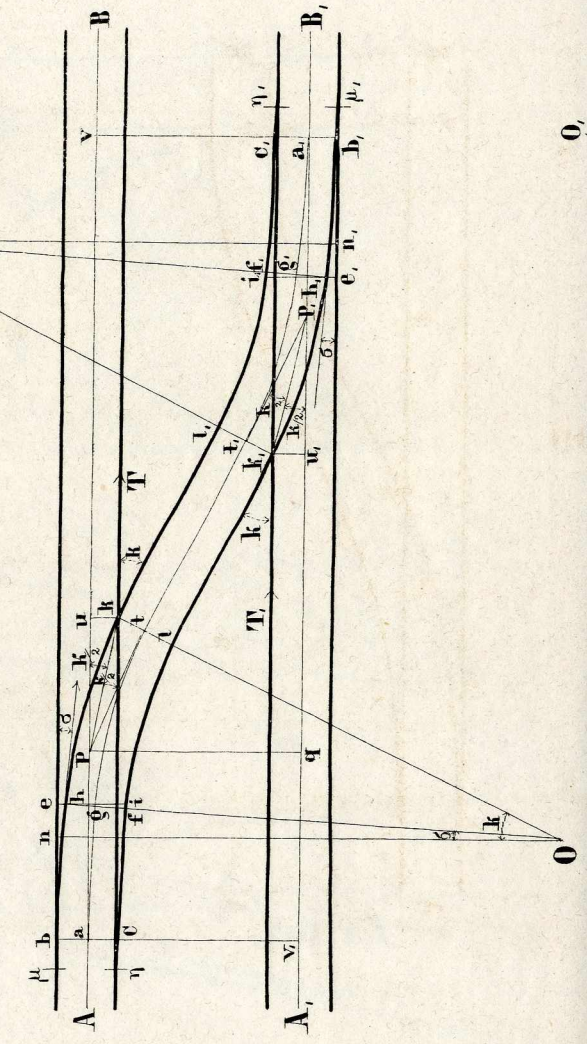

Сл. 109.

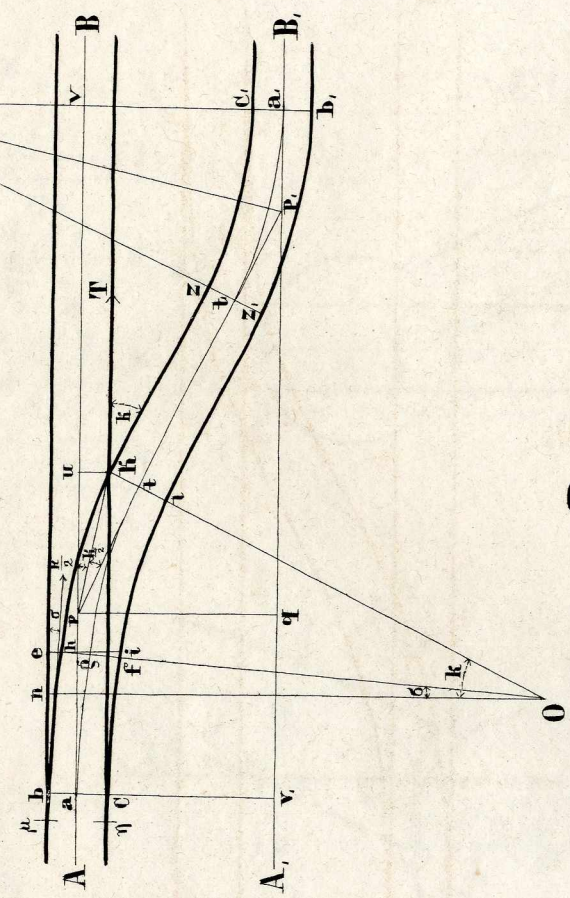

Сл. 110.

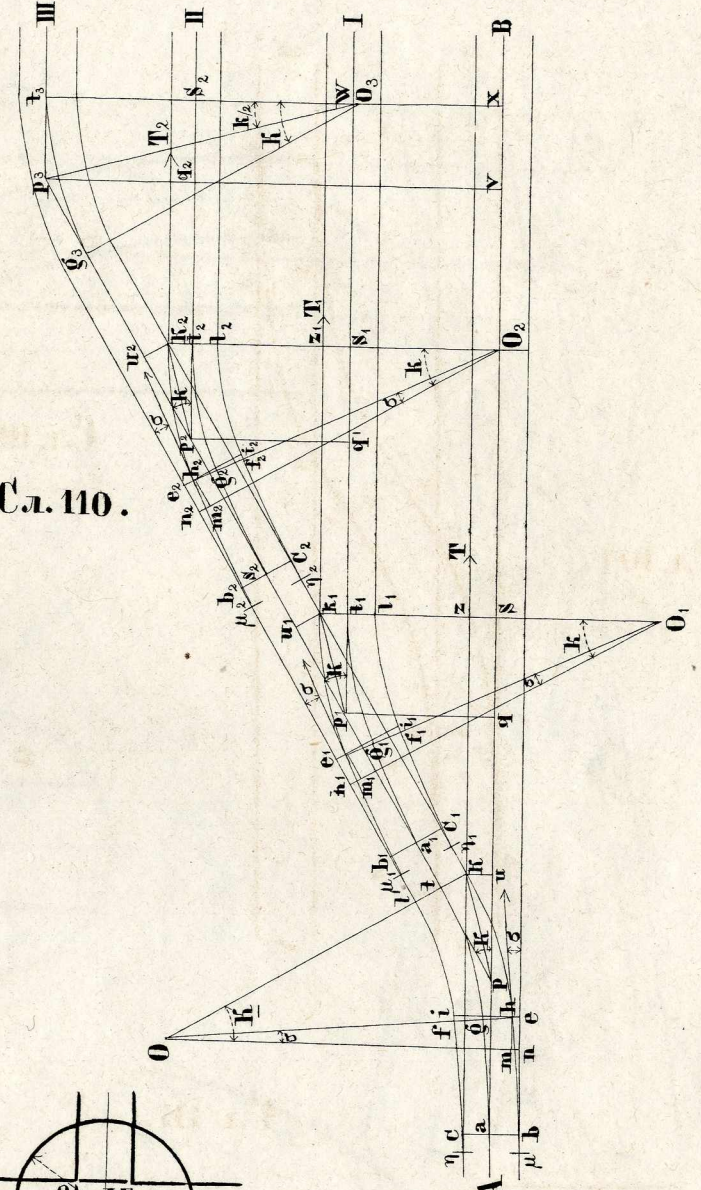

Сл. 111.

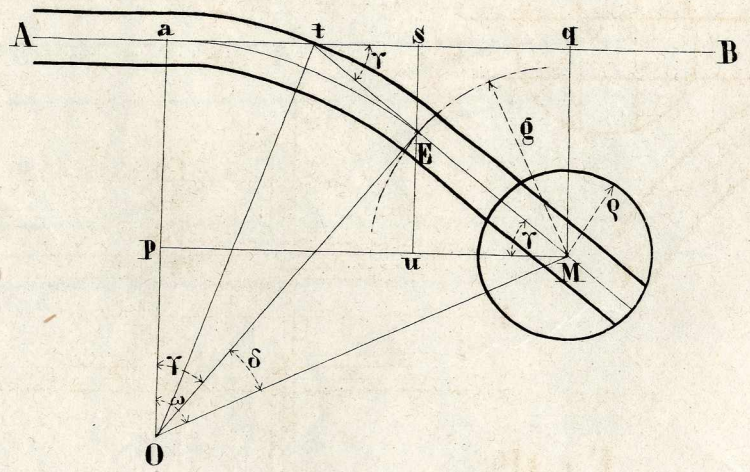

Сл. 112.

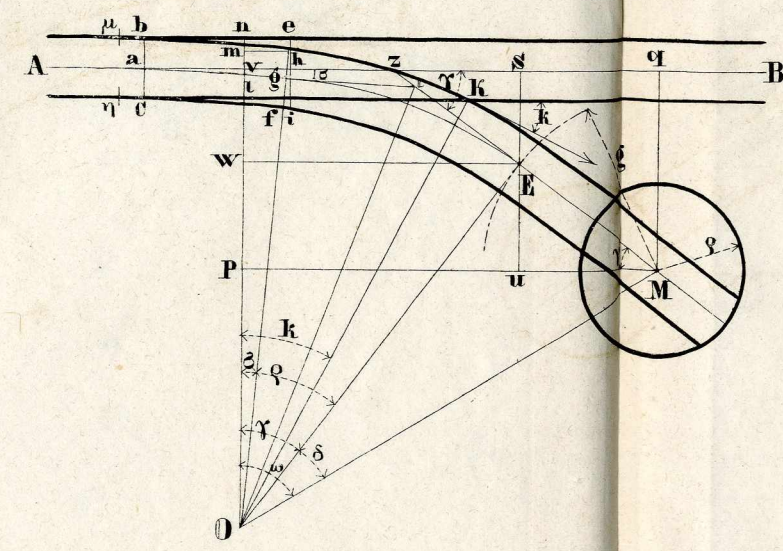

Сл. 113.

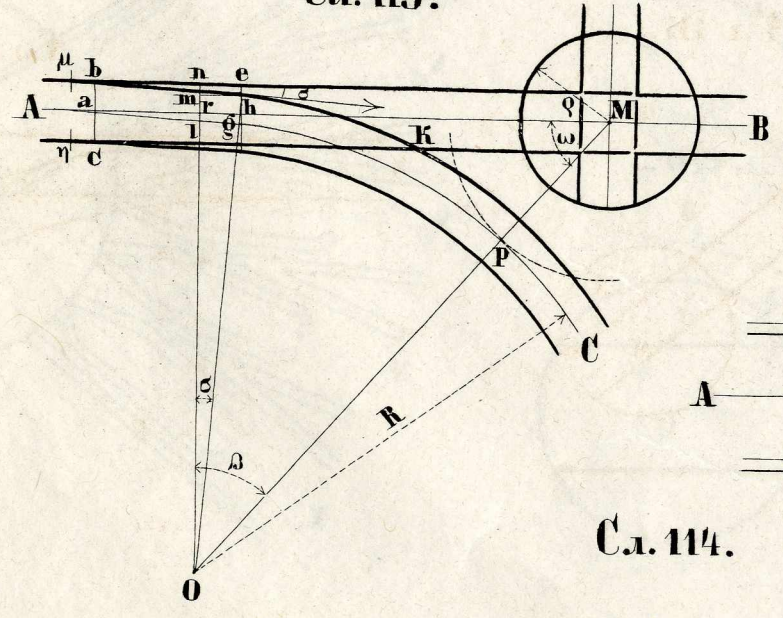

Сл. 114.

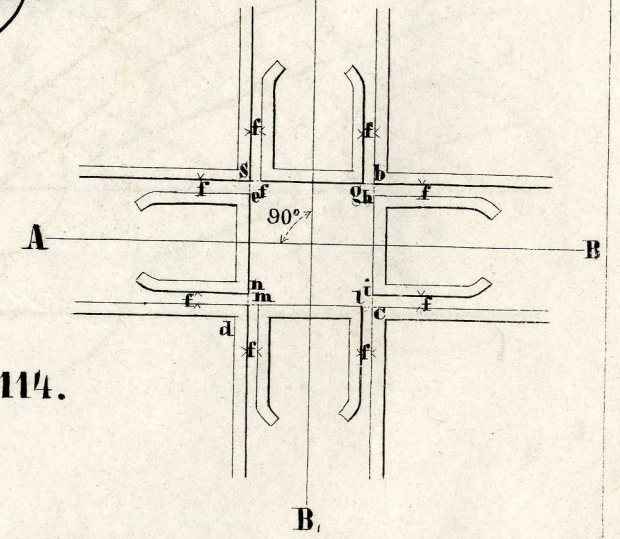

Сл. 115.

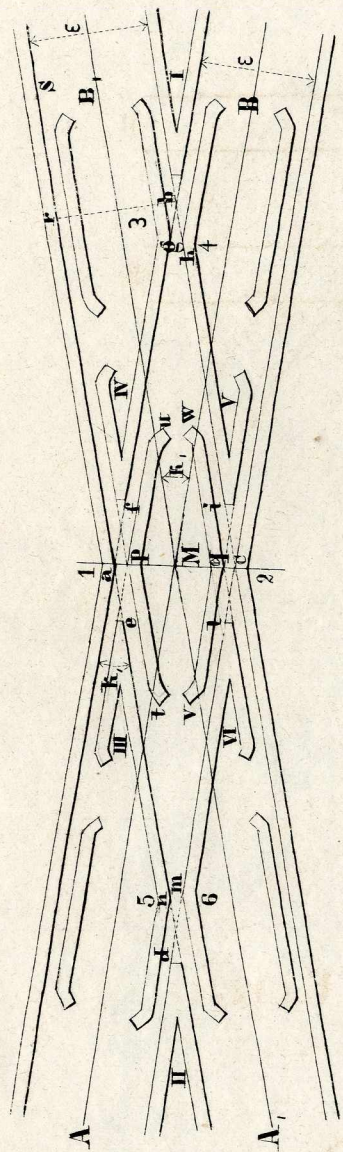

Сл. 121.

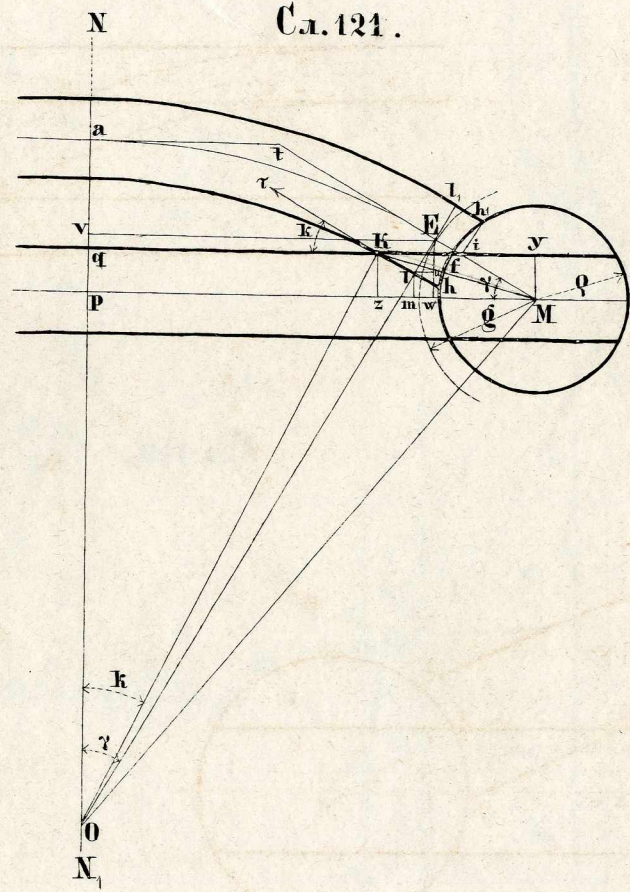

Сл. 118.

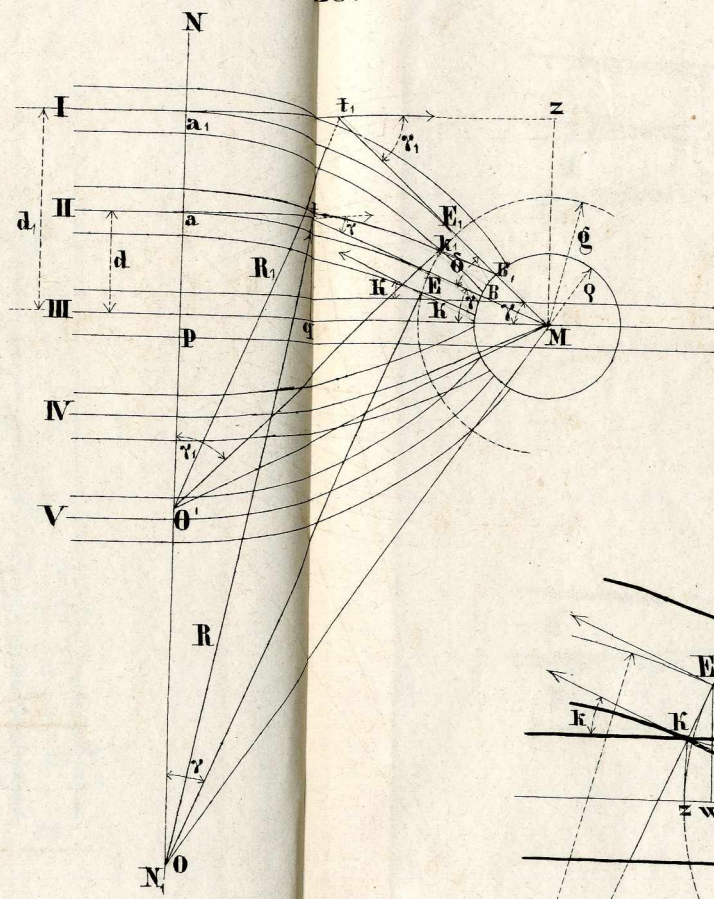

Сл. 116.

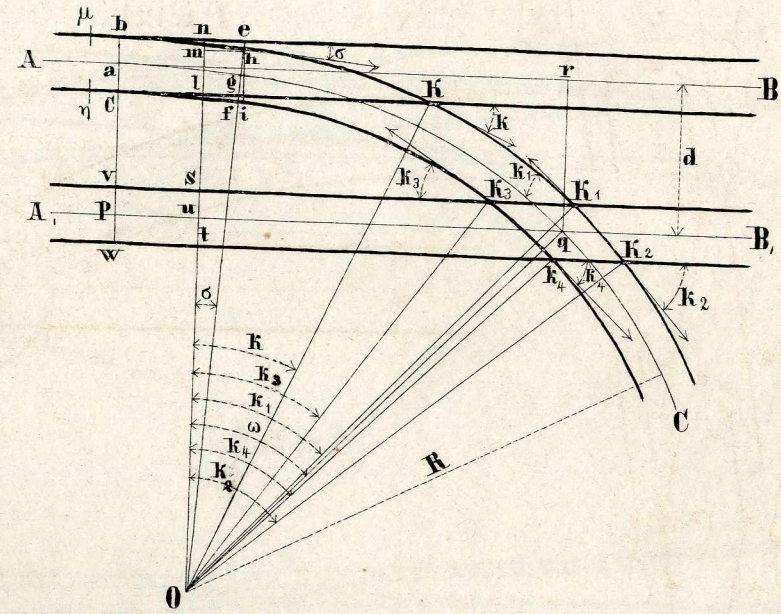

Сл. 120.

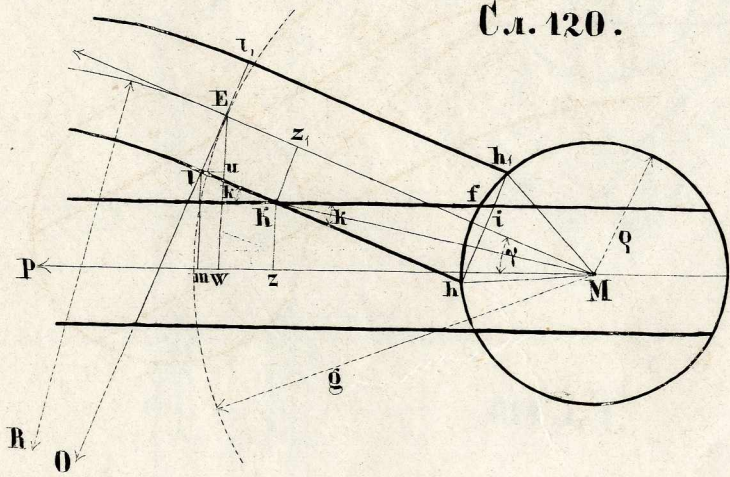

Сл. 117.

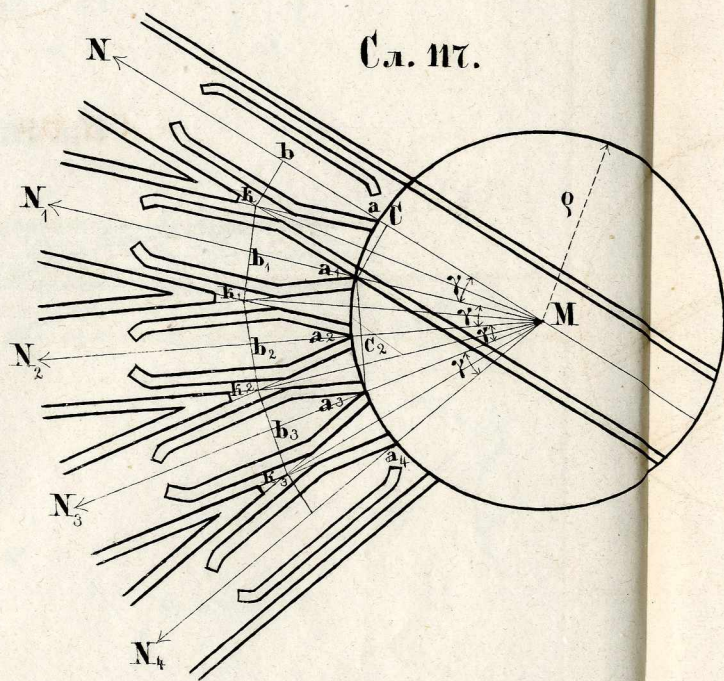

Сл. 119.

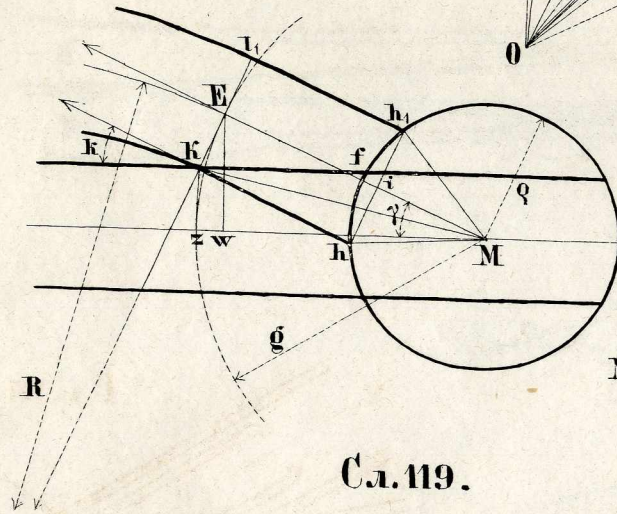

Сл. 122.

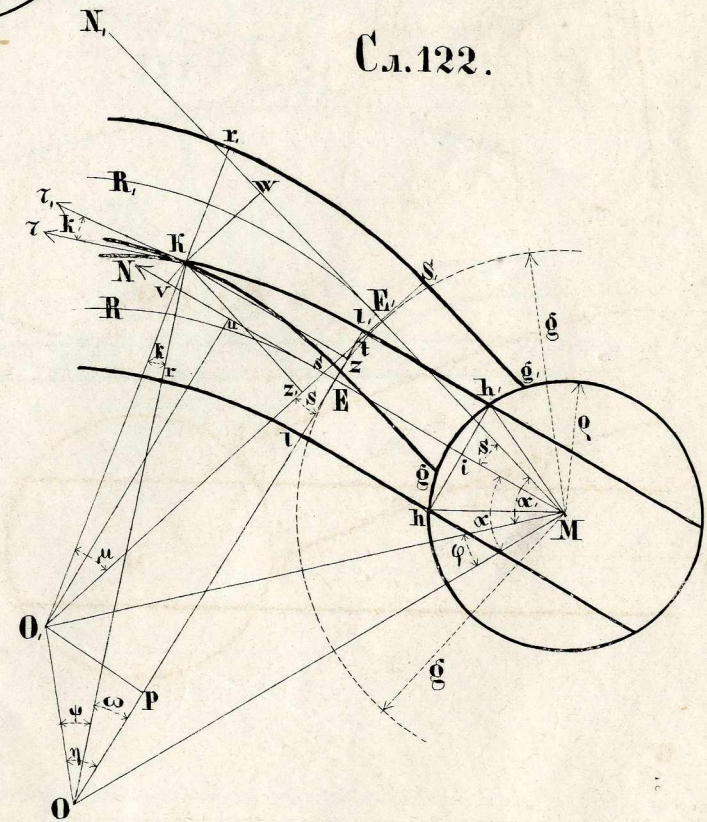

Сл. 123.

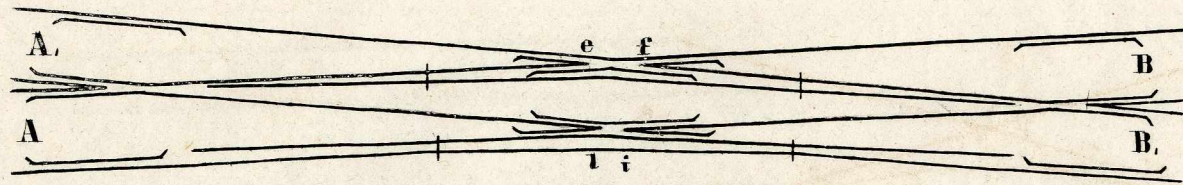

Сл. 124.

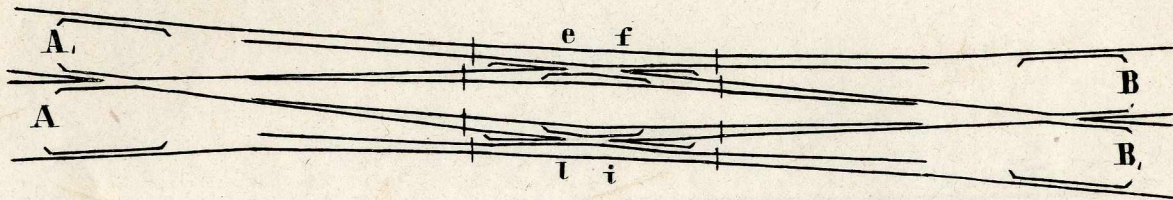

Сл. 127.

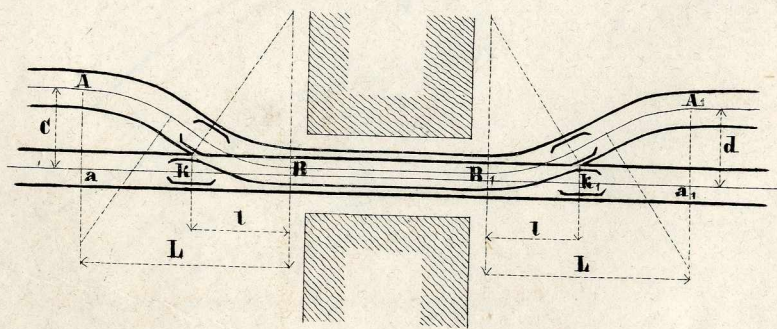

Сл. 125.

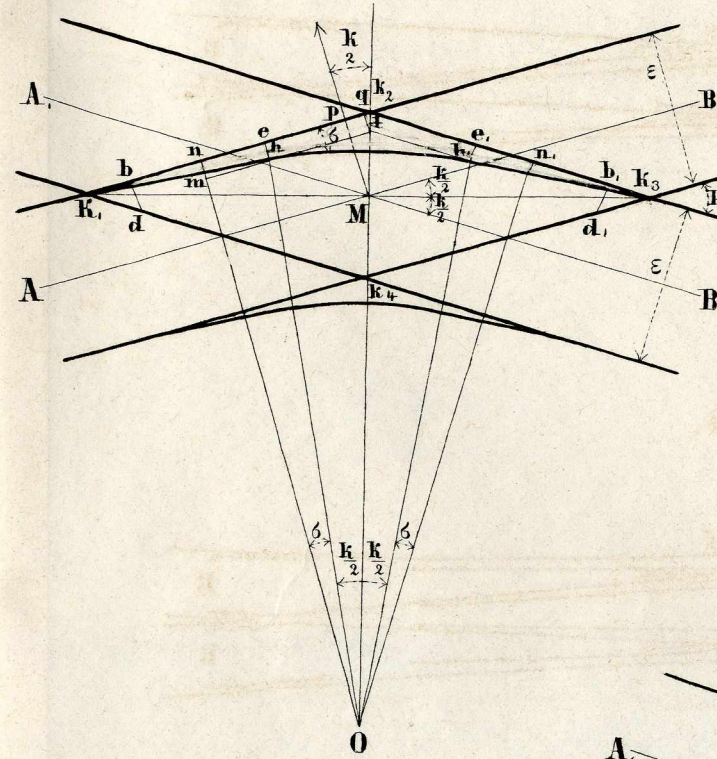

Сл. 128.

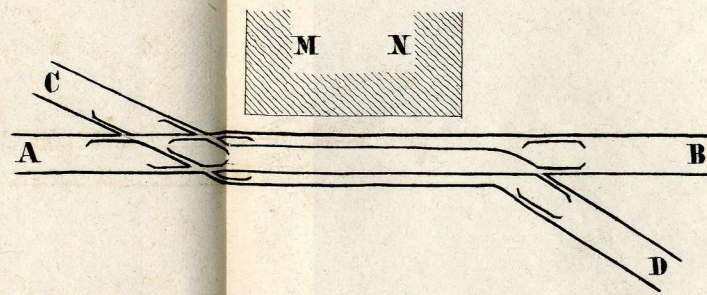

Сл. 126.

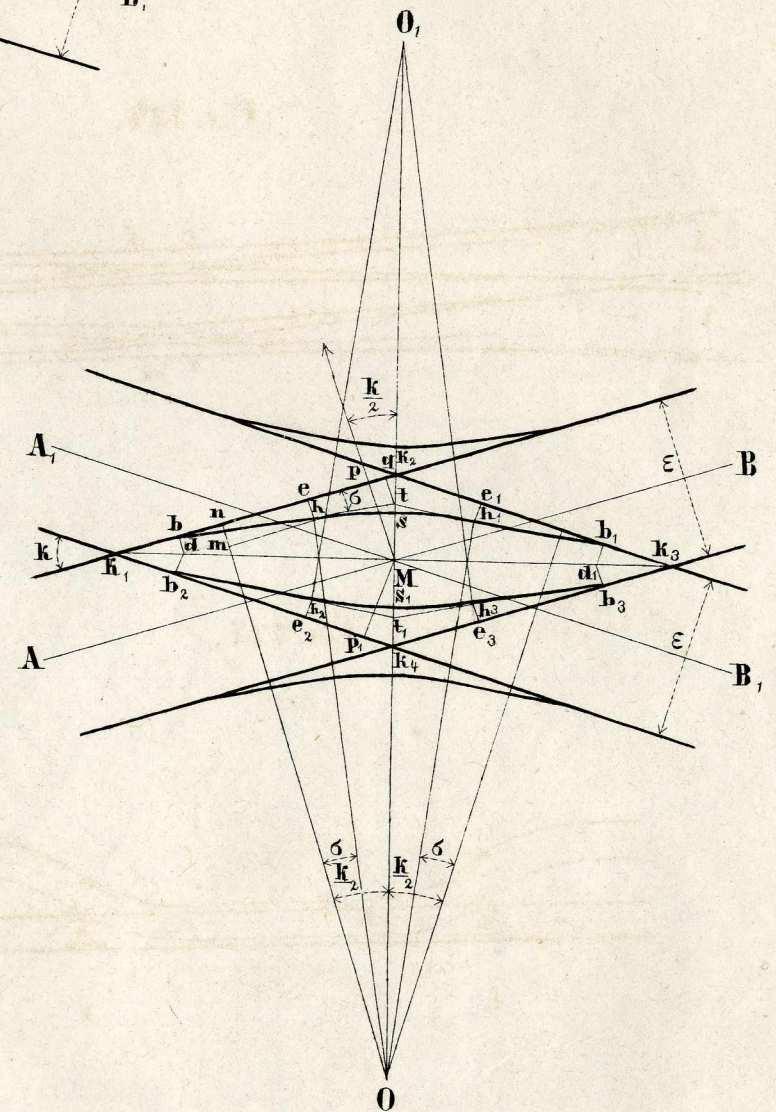

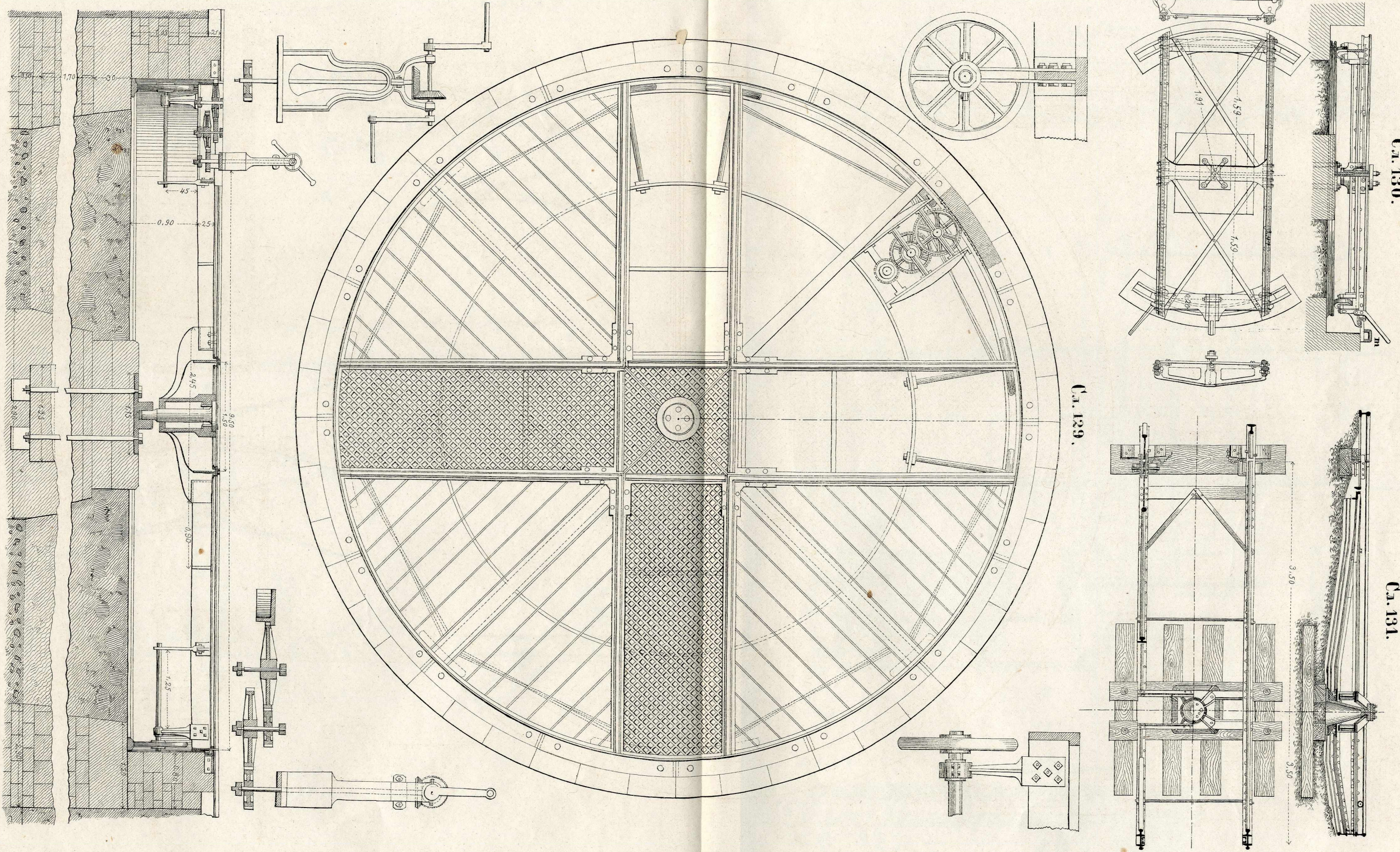

У ДРЖАВНОЈ КАМЕНОРЕЗНИЦИ У БЕОГРАДУ.

Сл. 133.

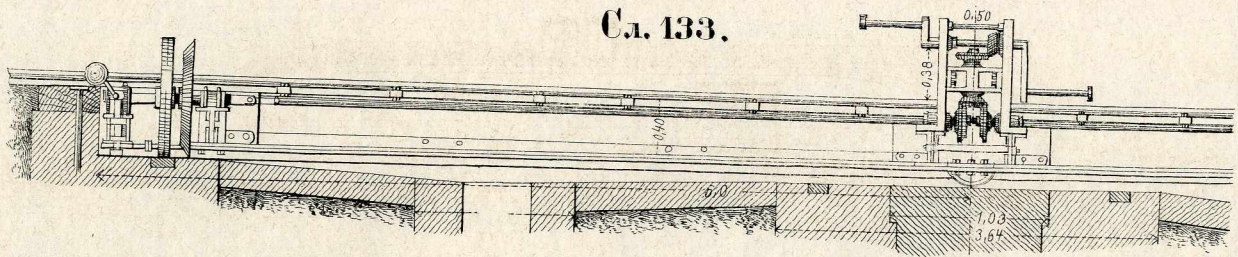

Сл. 132.

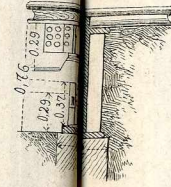

Сл. 134.

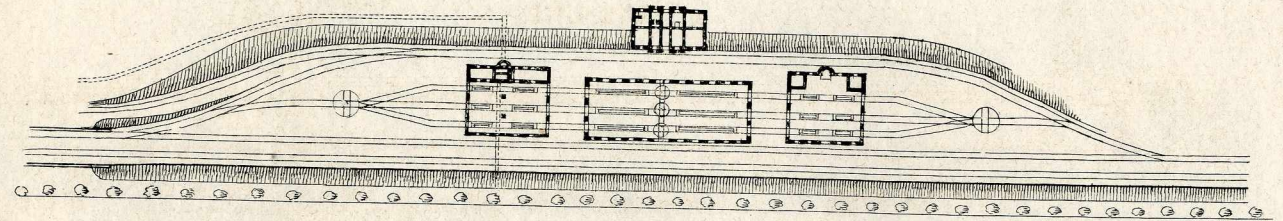

Сл. 137.

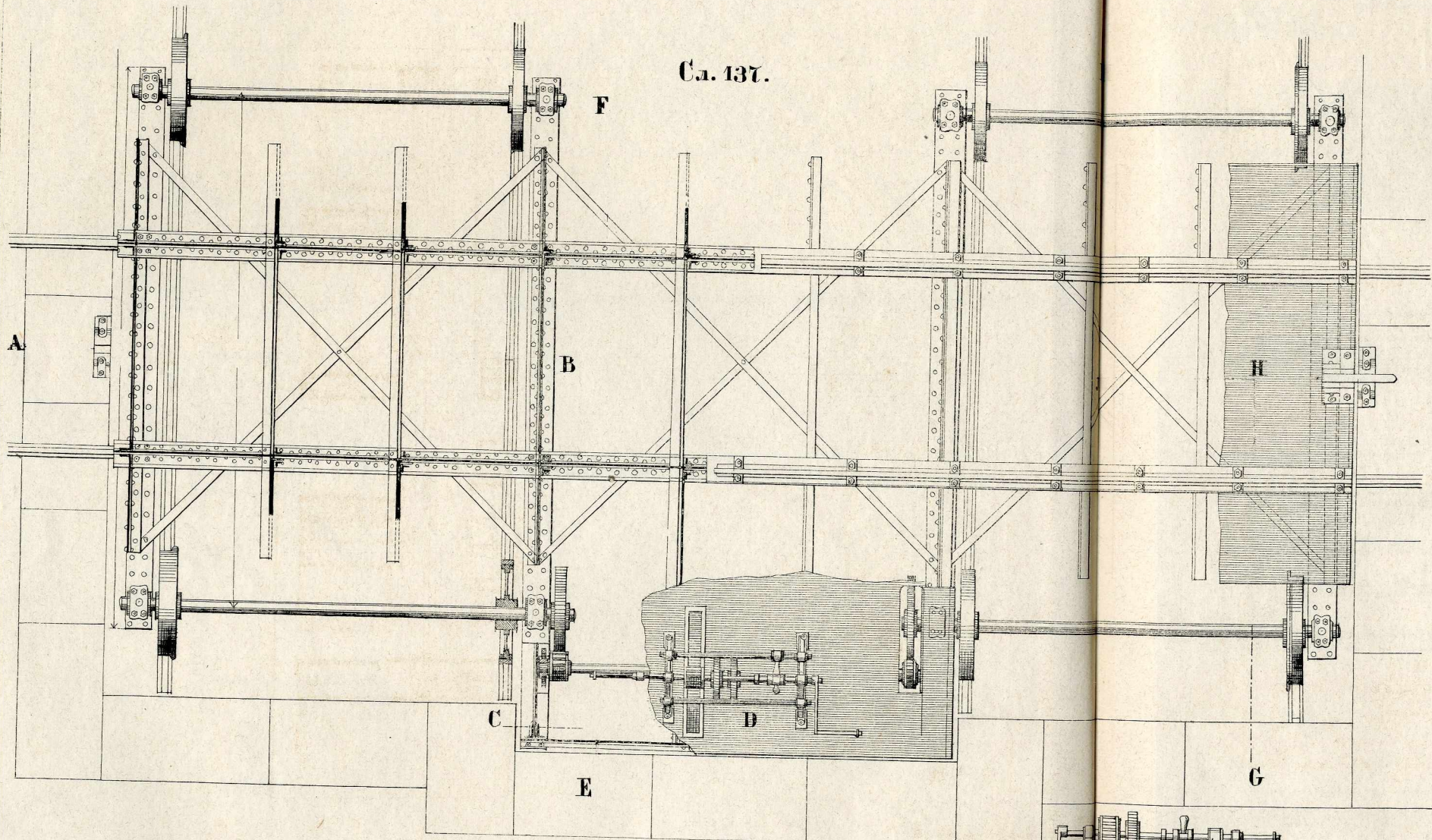

Сл. 135.

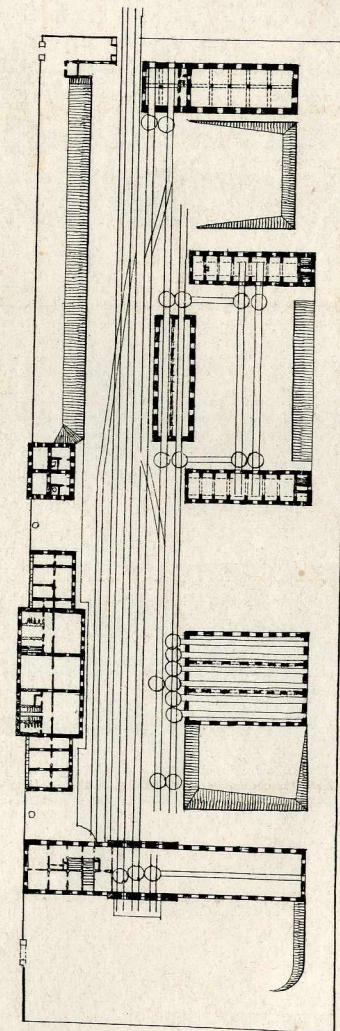

Пресек АВСД

Сл. 136.

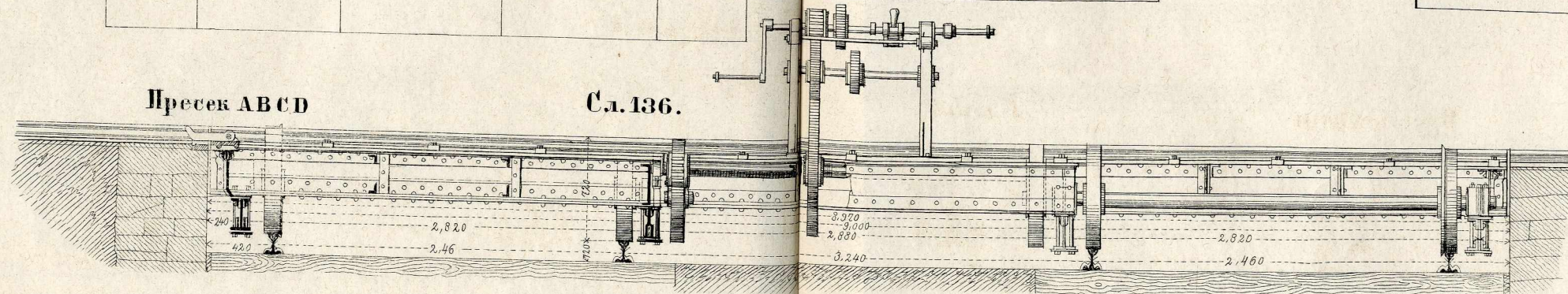

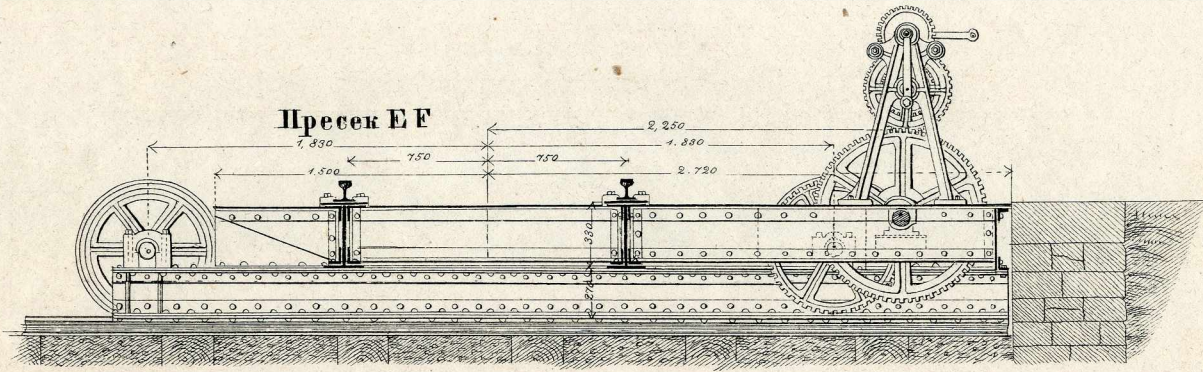

Сл. 138.

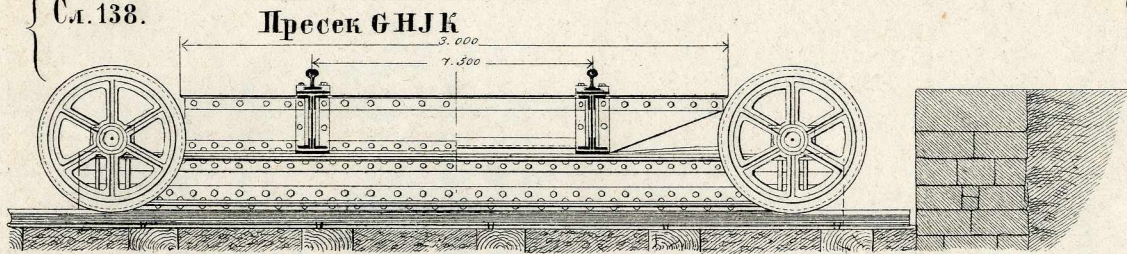

Сл. 141.

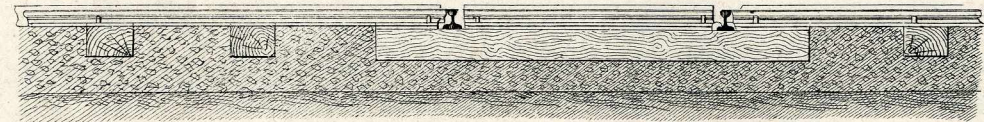

Сл. 142.

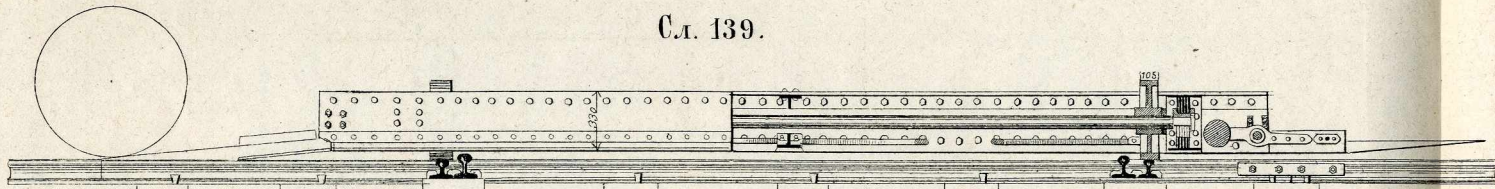
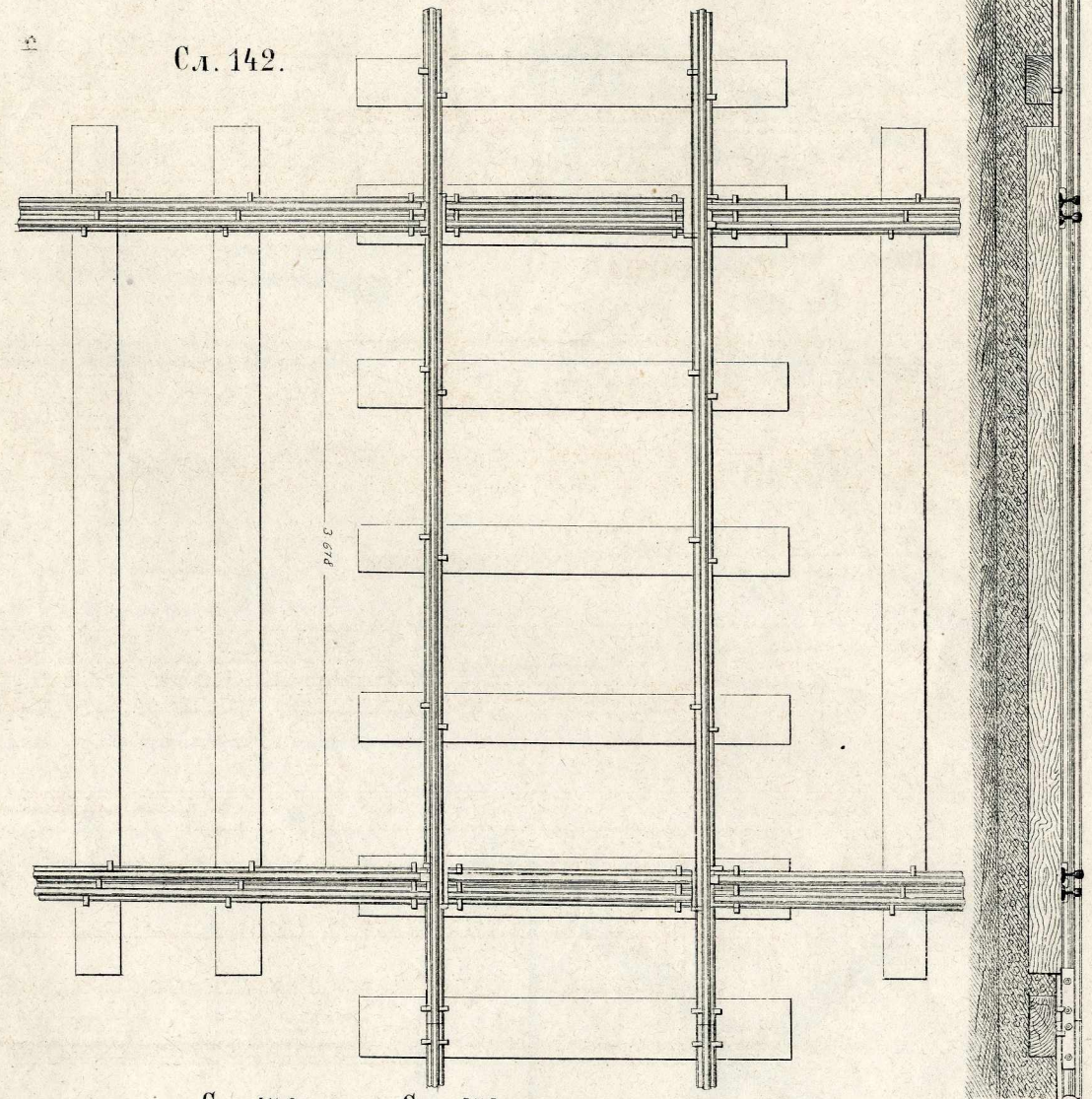

Сл. 139.

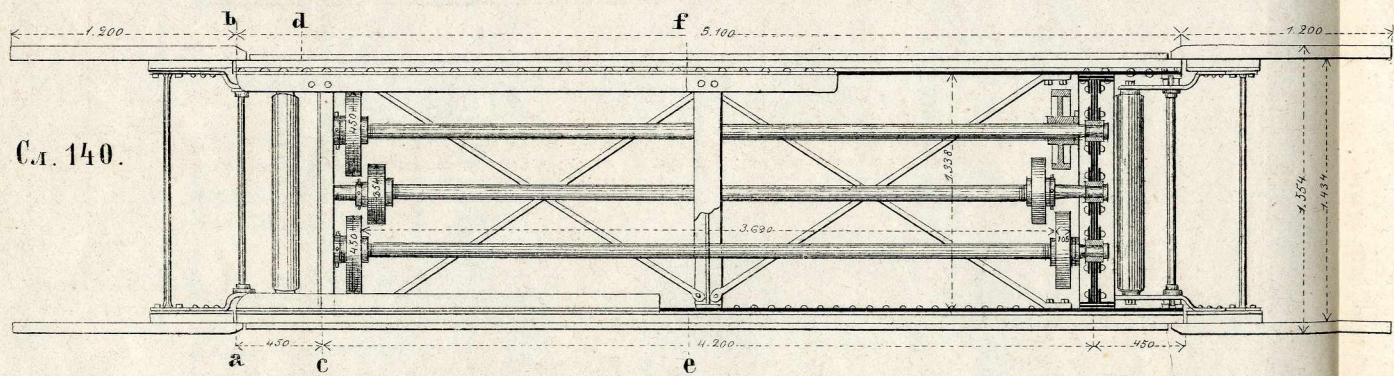

Сл. 140.

Сл. 147.

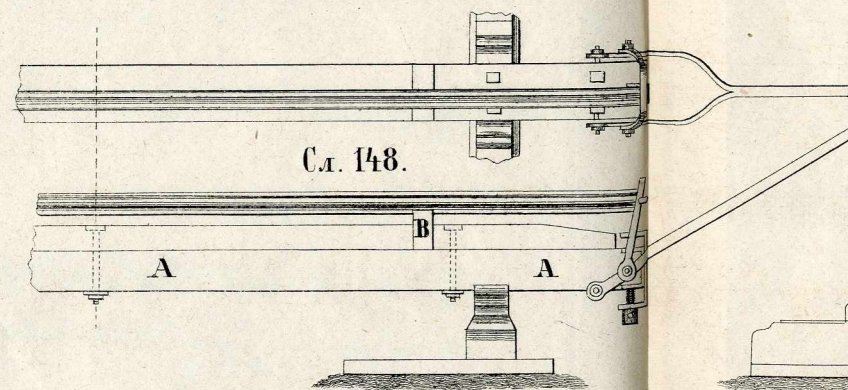

Сл. 148.

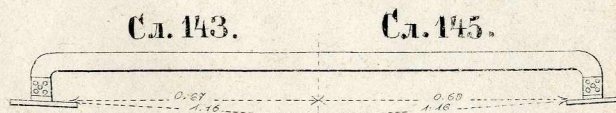

Сл. 143.

Сл. 145.

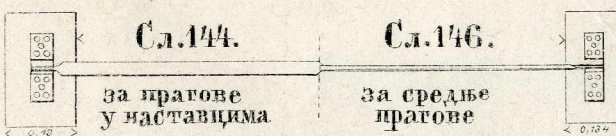

Сл. 144.

Сл. 146.

за прагове
у частавцима

за средње
прагове

Сл. 150.

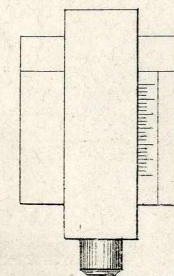

Сл. 151.

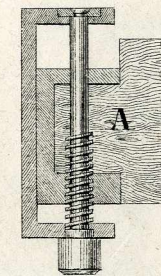

Сл. 153.

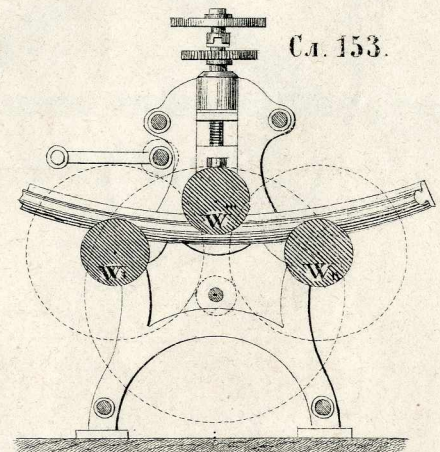

Сл. 149.

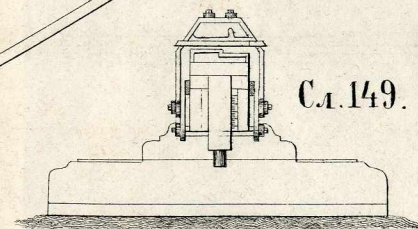

Сл. 152.

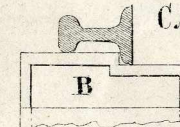

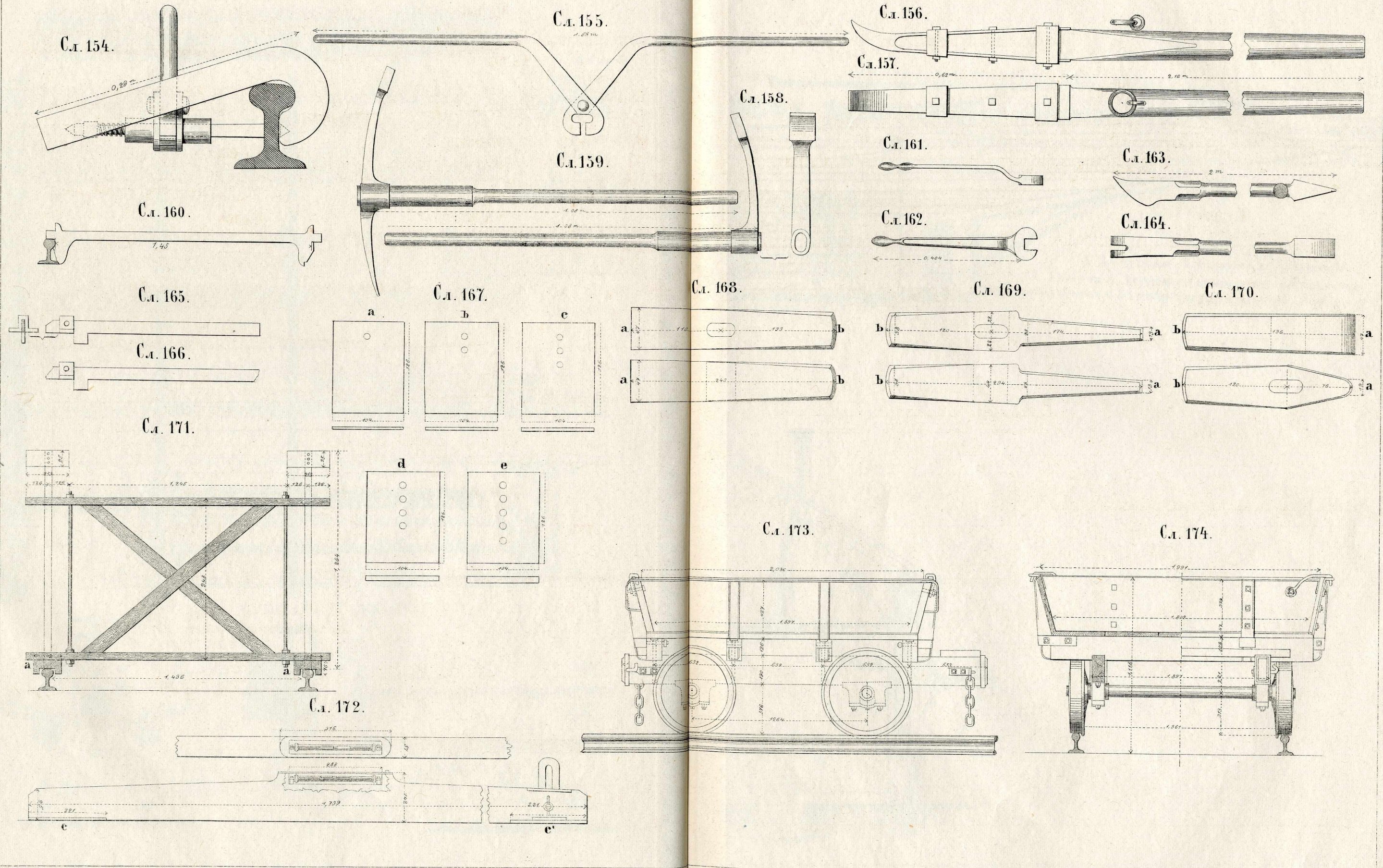

Сл. 176.

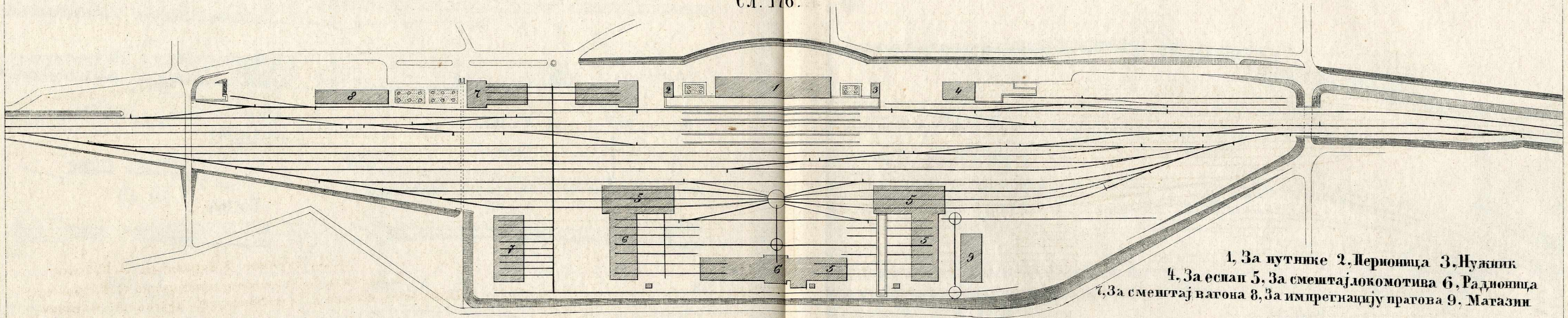

1, За путнике 2, Пероница 3, Нуџник
4, За еспап 5, За смештај локомотива 6, Радионица
7, За смештај вагона 8, За импрегнацију прагова 9, Магазин

Сл. 175.

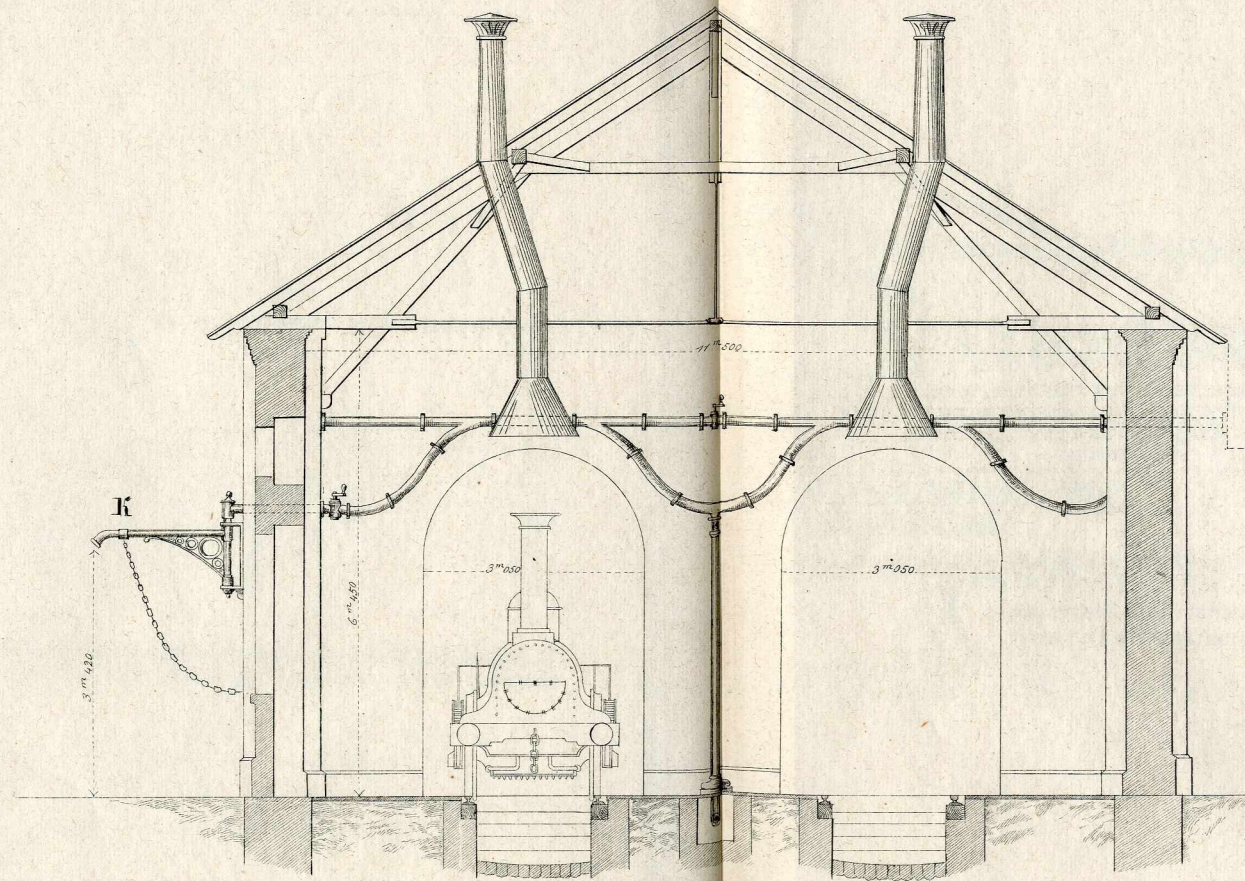

Сл. 177.

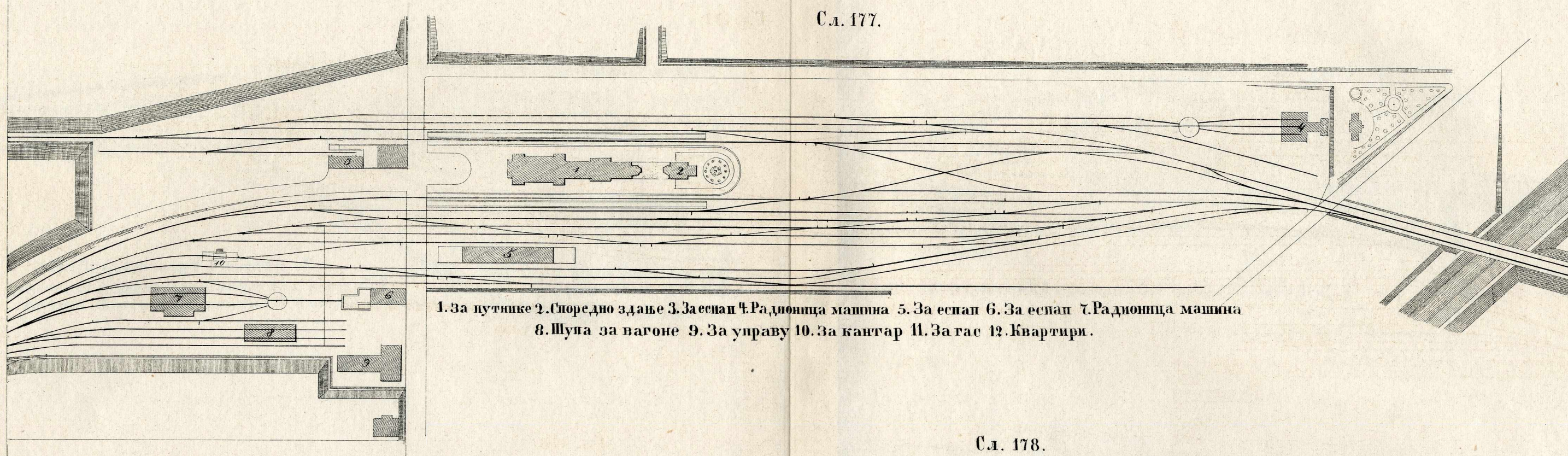

1. За путнике 2. Споредно здање 3. За еспап 4. Радионица машина 5. За еспап 6. За еспап 7. Радионица машина
8. Шупа за вагоне 9. За управу 10. За кантар 11. За гас 12. Квартури.

Сл. 178.

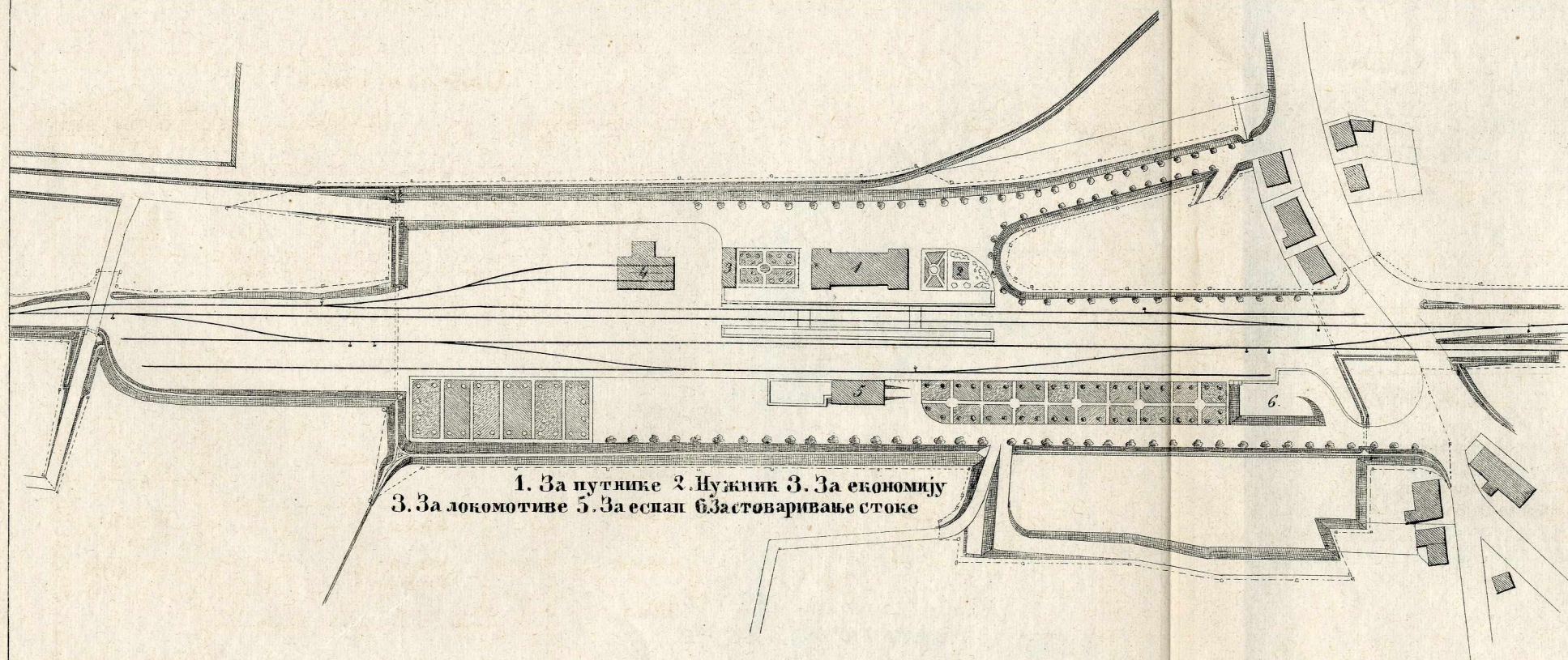

1. За путнике 2. Мужник 3. За економију
3. За локомотиве 5. За еспап 6. Застоваривање стокe

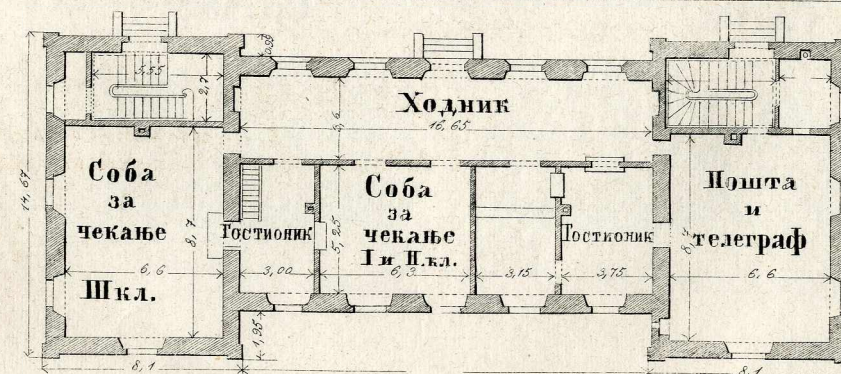
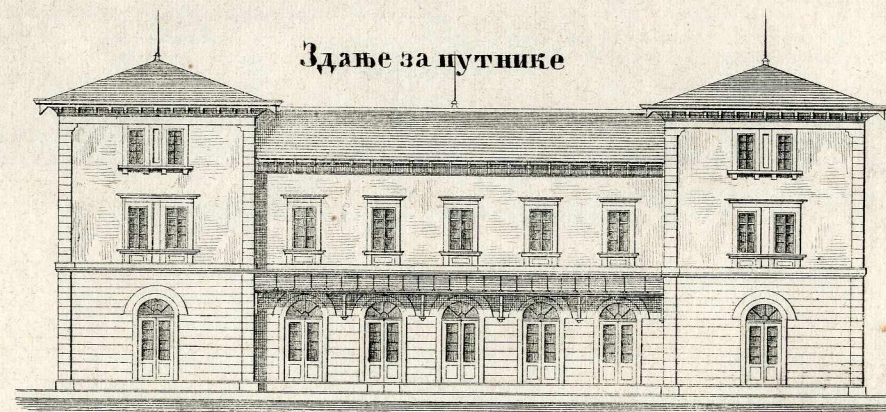

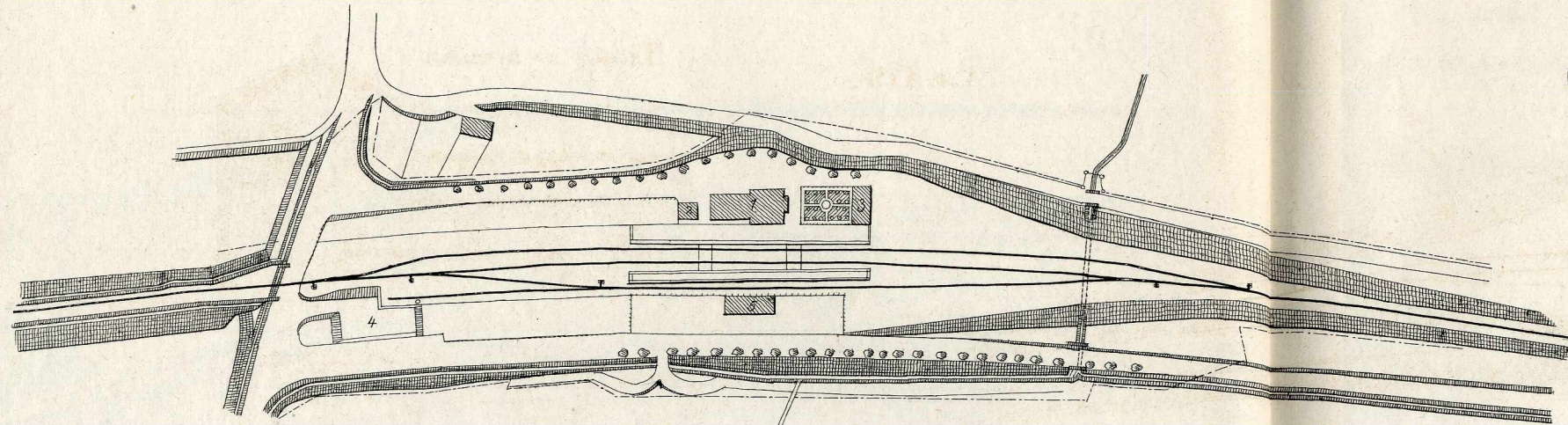

1. За Путнике 2. Мужик 3. За економју 4. За стоваривање стоке 5. За есал

Сл. 179.

Здање за путнике

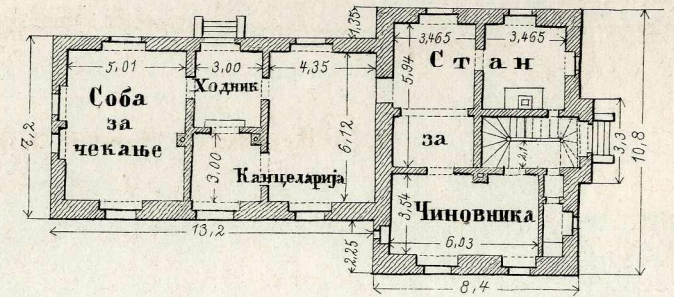

Сл. 180.

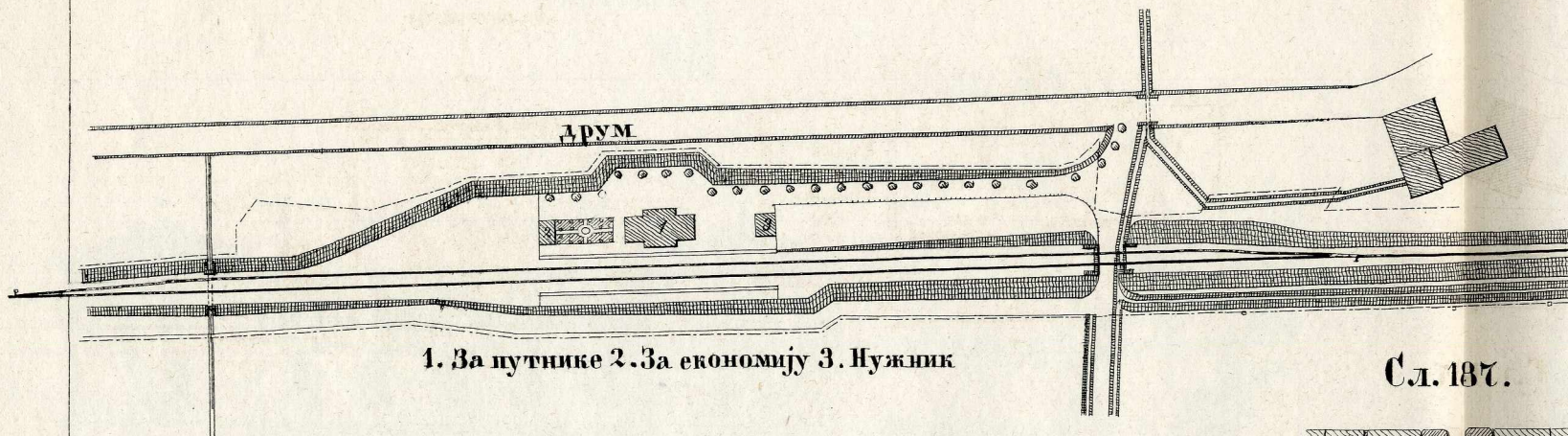

1. За путнике 2. За економју 3. Мужик

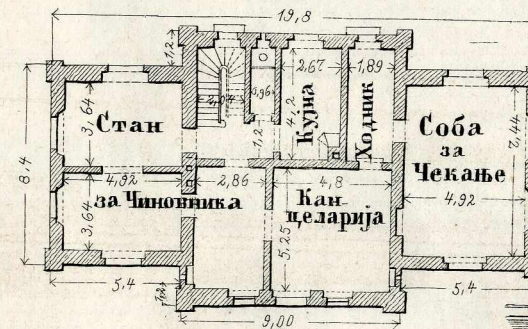

За путнике

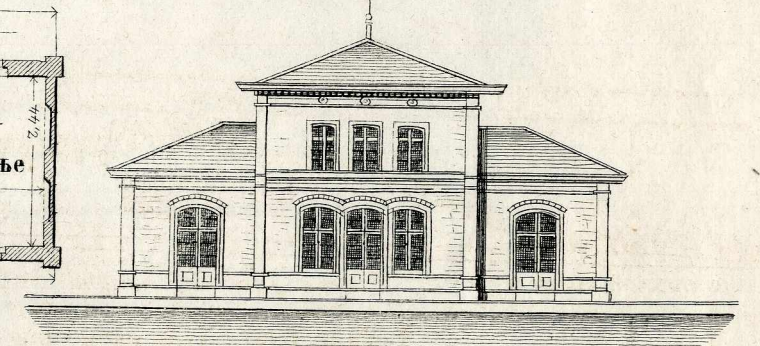

Сл. 187.

Сл. 181.

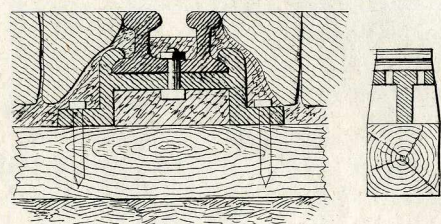

Сл. 182.

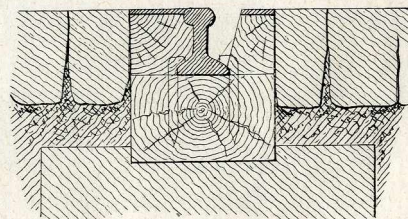

Сл. 183.

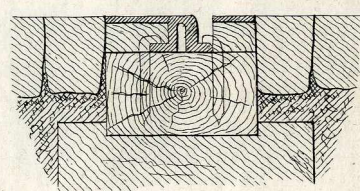

Сл. 184.

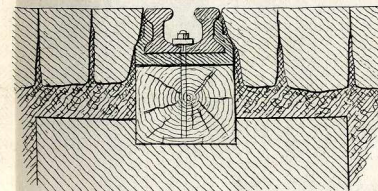

Сл. 185.

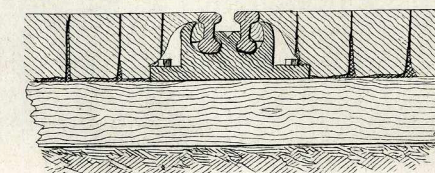

Сл. 186.

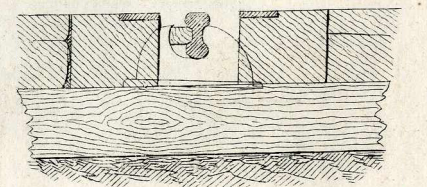

Сл. 188.

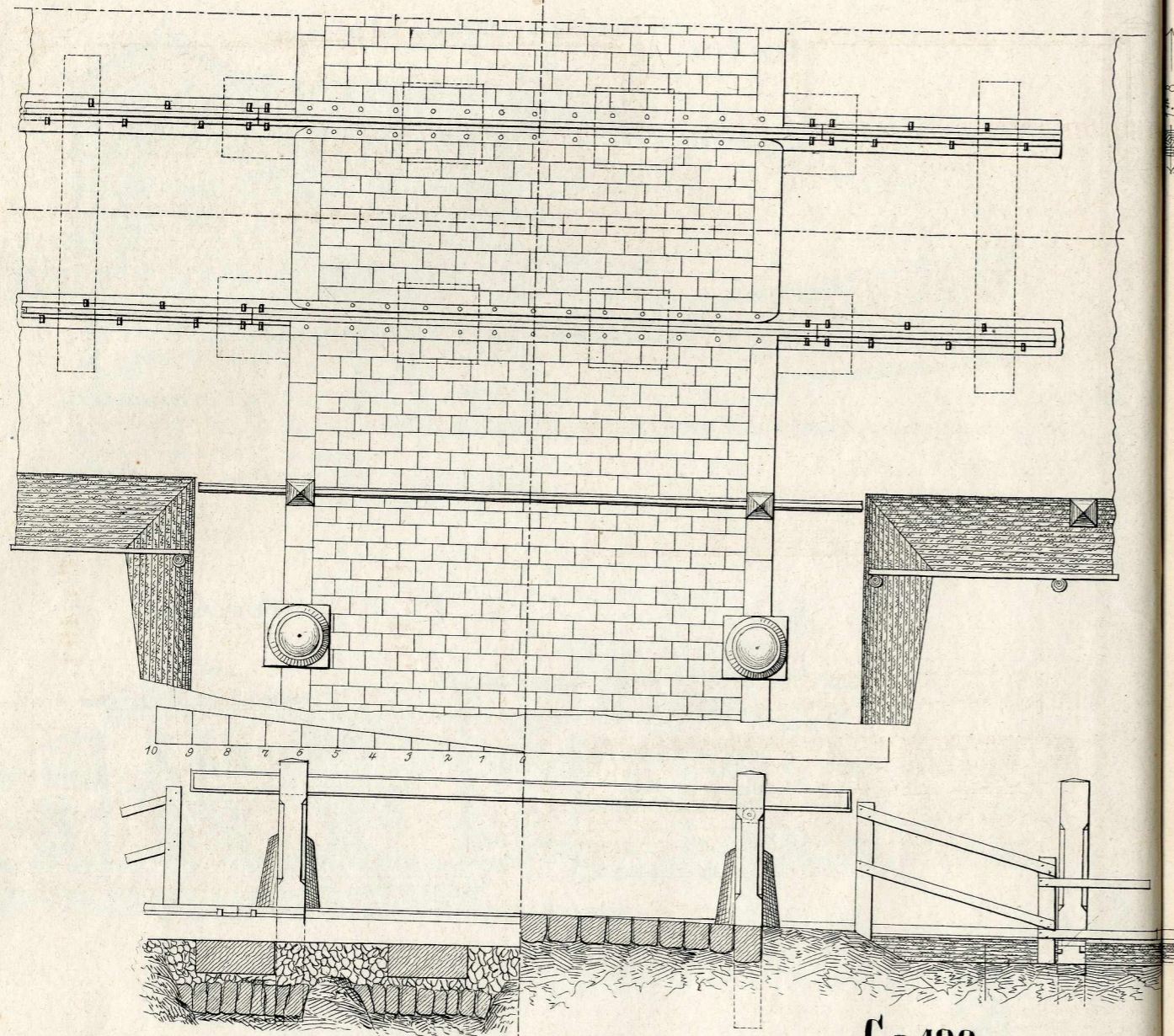

Сл. 190.

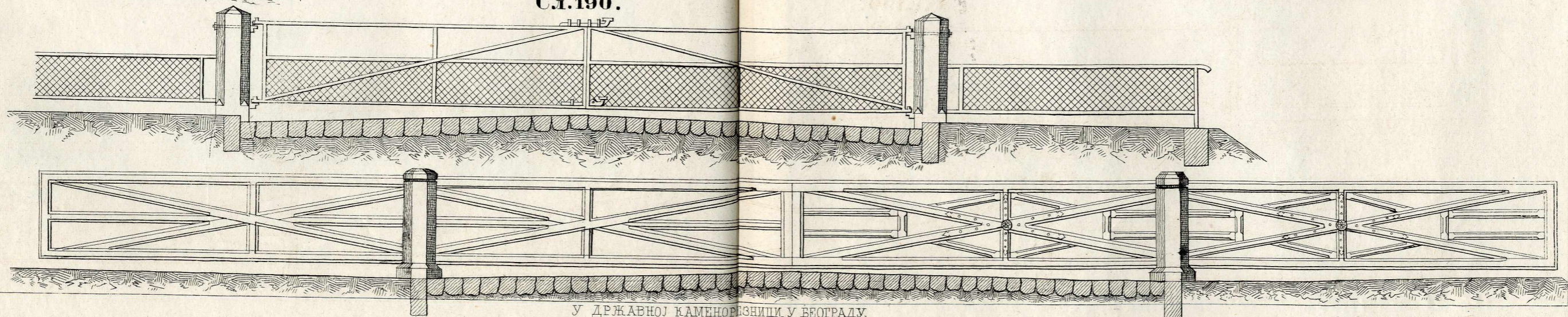

У ДРЖАВНОЈ КАМЕНОВЪЗНИЦИ У БЕОГРАДУ.

Сл. 189.

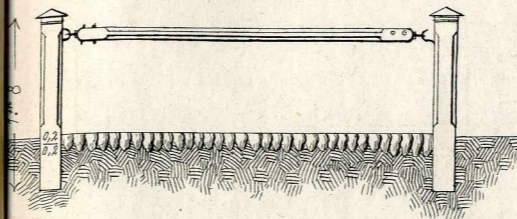

Сл. 191.

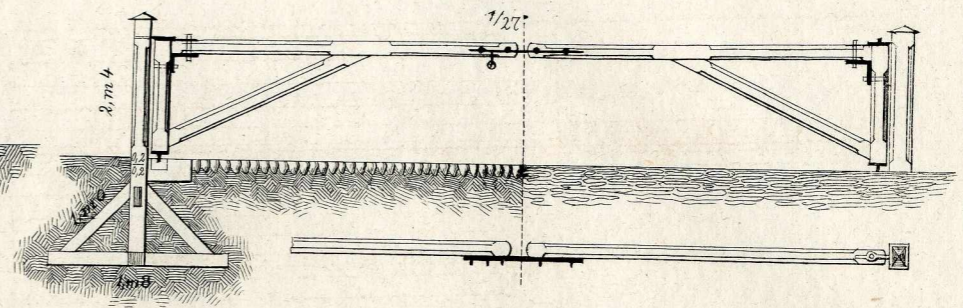

Сл. 193.

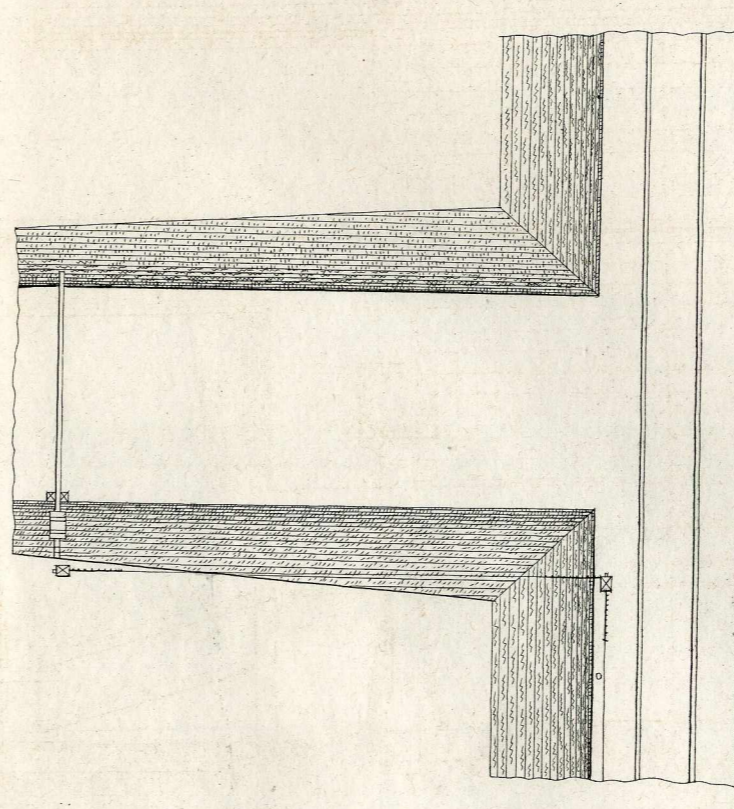

Сл. 192.

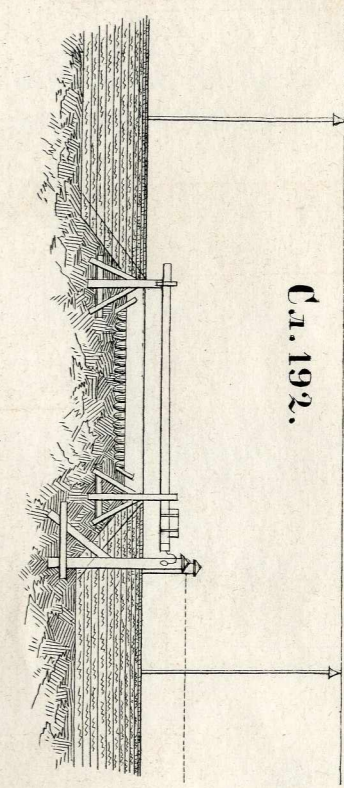

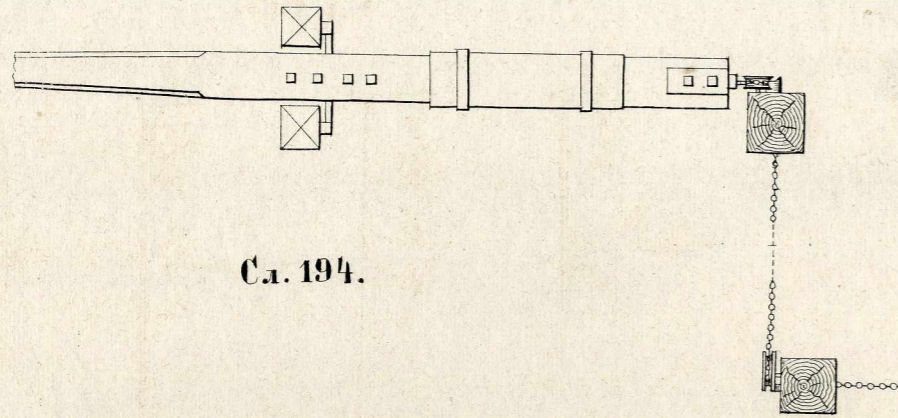

Сл. 194.

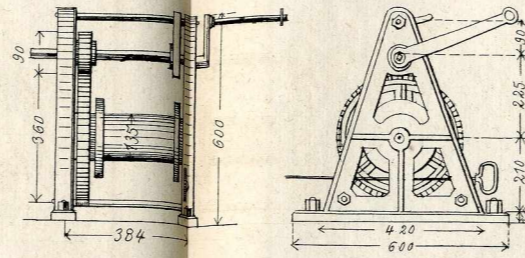

Сл. 196.

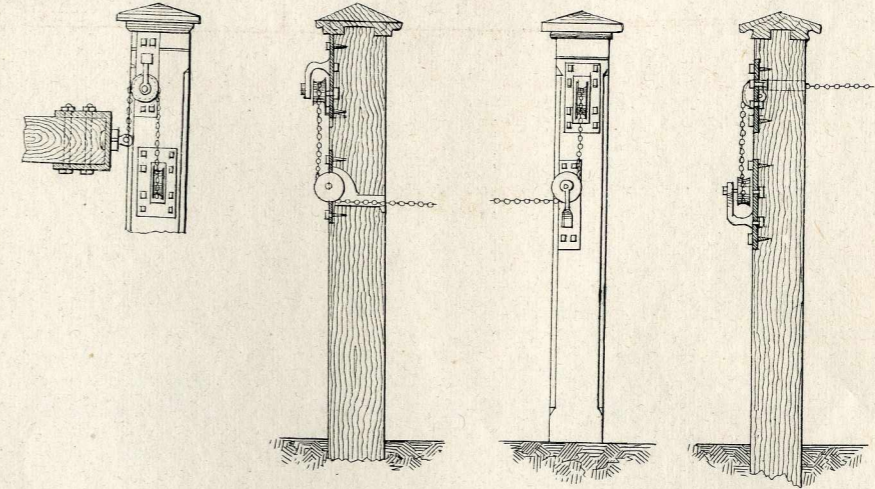

Сл. 195.

Сл. 197.

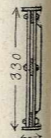
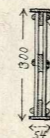
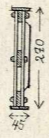
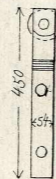
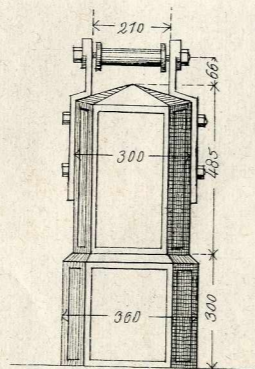
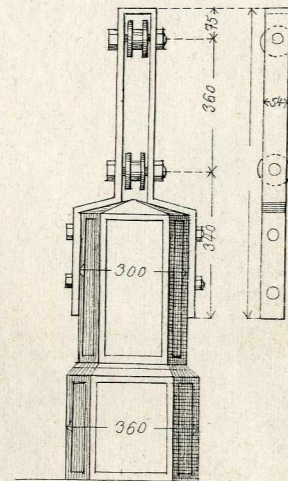
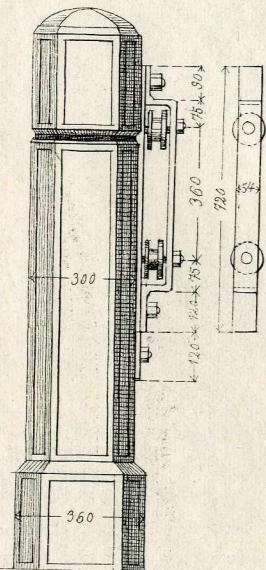
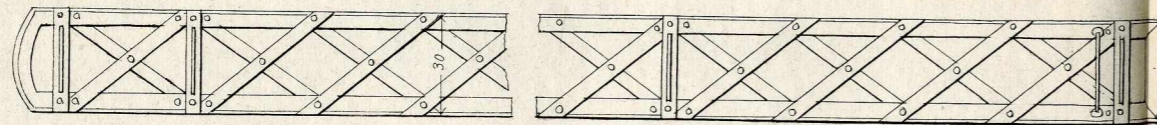
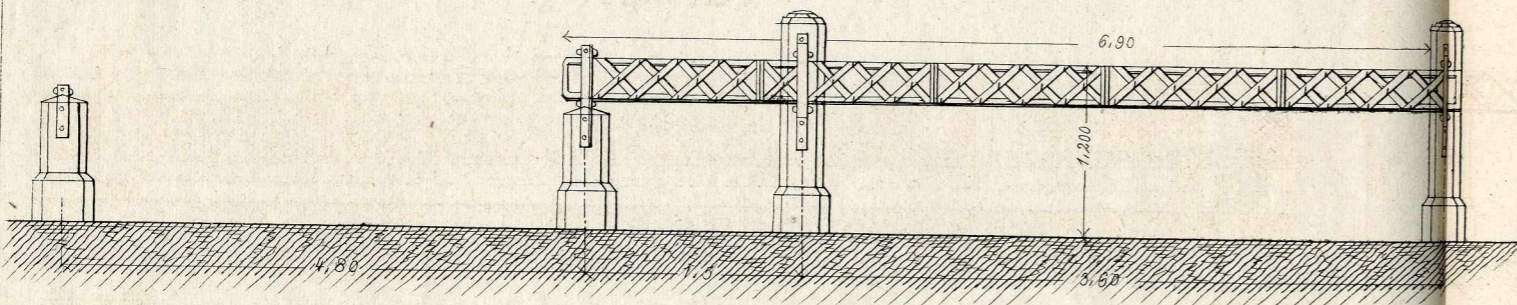

Сл. 198.

